



**THE DATASHEET OF
P9261-3CNLG2**



Description

The IDT P9260 and P9261 are highly integrated, magnetic induction wireless power transmitter controllers supporting the WPC Qi specifications or proprietary applications. Depending on the product code, the P9260/61 can function with a single coil or multiple coils in a full-bridge or half bridge inverter configuration. The P9260 is designed to support single-coil applications, and the P9261 is for multi-coil designs.

The P9260/61, which includes an industry-leading 32-bit ARM® Cortex®-M0 processor, offers a high level of programmability and extremely low standby power consumption. The transmitter generates power through the power coil, detects the presence of a wireless power receiver, decodes the communication packets from the receiver, and adjusts the transmitted power by controlling the voltage based on feedback from the receiver. The transmitter will enable the power receiver to output 15W if the bidirectional communication protocol can be established, or the power receiver will output only 5W for a standard 5W power receiver.

The transmitter detects if a foreign metal object is placed on the transmitter coil. To safeguard the device and the system under fault conditions, the P9260/61 includes input under-voltage, input over-voltage, output short-circuit, and over-temperature protection.

The microcontroller empowers the user to customize features such as LED patterns, foreign object detection (FOD) threshold settings, or the over-temperature threshold. The device supports the I2C serial interface protocol, which enables the user to control the basic parameters, such as operating mode, switching frequency, input current, and input voltage.

The P9260 is available in a lead-free, space-saving 7 × 7 mm, 48-QFN wettable flank package. The product is rated over the operating temperature range of -40°C to +105°C.

Features

- AEC-Q100, grade 2 qualified for automotive applications
- EMI/EMC performance meets the CISPR-25 specification
- Supports up to 15W wireless power receivers
- Wide input voltage range: 4.25V to 21V
- Fixed frequency and duty cycle wireless power topology
- WPC 1.2.4 compliant and will support future WPC compatibility; supports single or multiple coil configurations
- Embedded 32-bit ARM® Cortex®-M0 processor (trademark of ARM, Ltd.)
- OTP program memory; also supports external flash memory
- Supports I2C and SPI interfaces
- Integrated drivers for external power FETs and current voltage sensing
- Low standby power
- Integrated step-down switching regulator for internal blocks to increase overall efficiency
- Advanced foreign objects detection (FOD) and Q-factor function
- Supports LEDs for status indication and alignment aid
- Over-current, over-voltage, and over-temperature protection
- Dedicated remote temperature sensing
- 7 × 7 mm, 48-QFN wettable flank RoHS-compliant package
- -40°C to +105°C ambient operating temperature range

Typical Applications

- Automotive in-cabin WPC Qi 1.2.4 wireless charger

Simplified P9261 Application Schematic

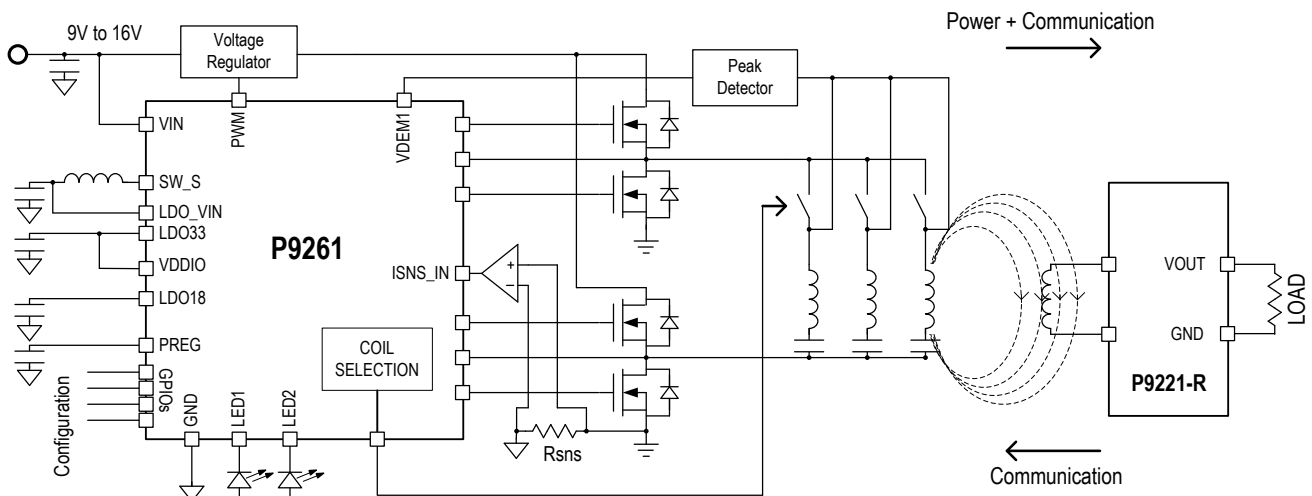

Functional Block Diagram

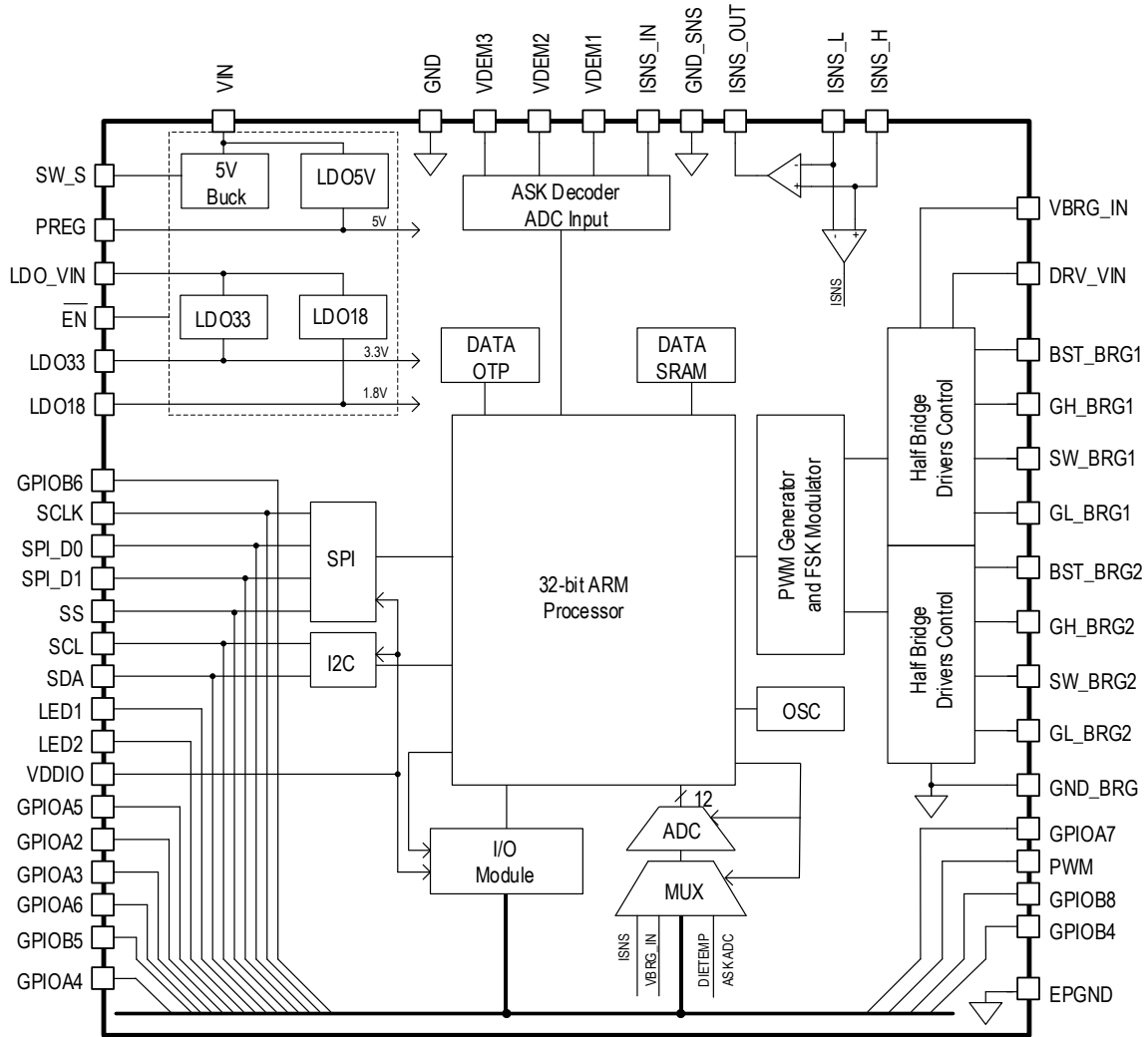

IMPORTANT NOTICE AND DISCLAIMER

RENESAS ELECTRONICS CORPORATION AND ITS SUBSIDIARIES (“RENESAS”) PROVIDES TECHNICAL SPECIFICATIONS AND RELIABILITY DATA (INCLUDING DATASHEETS), DESIGN RESOURCES (INCLUDING REFERENCE DESIGNS), APPLICATION OR OTHER DESIGN ADVICE, WEB TOOLS, SAFETY INFORMATION, AND OTHER RESOURCES “AS IS” AND WITH ALL FAULTS, AND DISCLAIMS ALL WARRANTIES, EXPRESS OR IMPLIED, INCLUDING, WITHOUT LIMITATION, ANY IMPLIED WARRANTIES OF MERCHANTABILITY, FITNESS FOR A PARTICULAR PURPOSE, OR NON-INFRINGEMENT OF THIRD-PARTY INTELLECTUAL PROPERTY RIGHTS.

These resources are intended for developers who are designing with Renesas products. You are solely responsible for (1) selecting the appropriate products for your application, (2) designing, validating, and testing your application, and (3) ensuring your application meets applicable standards, and any other safety, security, or other requirements. These resources are subject to change without notice. Renesas grants you permission to use these resources only to develop an application that uses Renesas products. Other reproduction or use of these resources is strictly prohibited. No license is granted to any other Renesas intellectual property or to any third-party intellectual property. Renesas disclaims responsibility for, and you will fully indemnify Renesas and its representatives against, any claims, damages, costs, losses, or liabilities arising from your use of these resources. Renesas' products are provided only subject to Renesas' Terms and Conditions of Sale or other applicable terms agreed to in writing. No use of any Renesas resources expands or otherwise alters any applicable warranties or warranty disclaimers for these products.

(Disclaimer Rev.1.01 Jan 2024)

Corporate Headquarters

TOYOSU FORESIA, 3-2-24 Toyosu,
Koto-ku, Tokyo 135-0061, Japan
www.renesas.com

Trademarks

Renesas and the Renesas logo are trademarks of Renesas Electronics Corporation. All trademarks and registered trademarks are the property of their respective owners.

Contact Information

For further information on a product, technology, the most up-to-date version of a document, or your nearest sales office, please visit www.renesas.com/contact-us/.

Looking for pricing, stock, or lifecycle information?

Click below to explore more details on WIN SOURCE:

-  [View P9261-3CNLG2 on WIN SOURCE](#)
-  [Renesas Electronics America](#) Information

Optimize Your Supply Chain with WIN SOURCE Solutions

-  Global Sourcing Solution
-  Obsolete Management
-  Cost Control Management
-  Shortage Management
-  Alternative Solution
-  Excess Inventory Management