



**THE DATASHEET OF
NX3225SA-25.000MHZ-STD-CSR-1**



Specification of Quartz Crystal Units

1	NDK Part Number	See table 1
2	NDK Specification Number	STD-CSR-1
3	Type	NX3225SA
4	Electrical Characteristics	
4.1	Nominal Frequency (f_{nom})	See table 1
4.2	Overtone order	Fundamental
4.3	Frequency Tolerance	$\pm 15 \times 10^{-6}$ max. (+25 °C)
4.4	Frequency Versus Temperature Characteristics	$\pm 15 \times 10^{-6}$ max. (-10 ~ +75 °C) The reference temperature shall be +25 °C
4.5	Equivalent Series Resistance (R_r)	See table 1
4.6	Shunt Capacitance (C_0)	NA
4.7	Maximum Drive Level	200 μ W max.
5	Measurement Circuit	
5.1	Frequency Measurement	
5.1.1	Measuring Instrument	π -network
5.1.2	Load Capacitance (C_L)	8 pF
5.1.3	Level of Drive	10 μ W
5.2	Equivalent Resistance Measurement	
5.2.1	Measuring Instrument	π -network
5.2.2	Load Capacitance (C_L)	Series
5.2.3	Level of Drive	10 μ W
6	Operable Temperature Range	-10 ~ +75 °C
7	Storage Temperature Range	-40 ~ +85 °C
8	Dimension	

(Unit: mm)

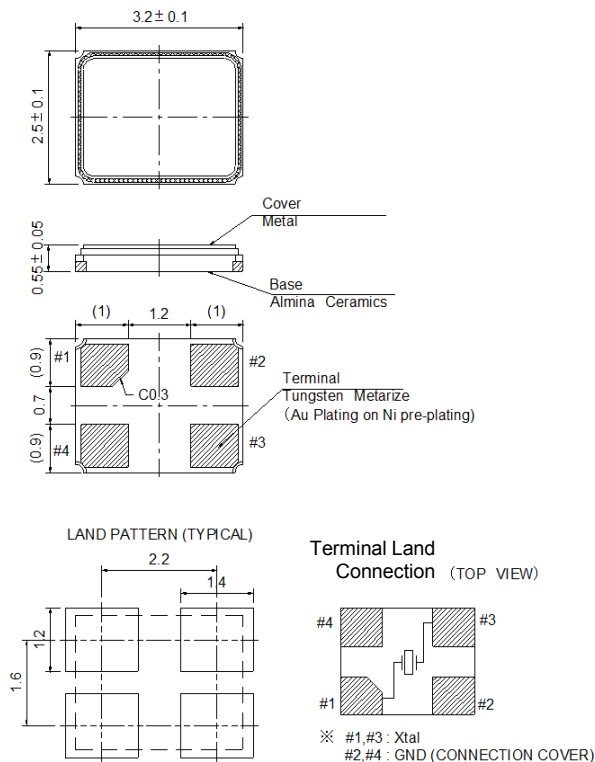

Table1

f_{nom} (MHz)	R_r (Ω) max.	NDK Part Number
12.000	100	NX3225SA-12.000M-STD-CSR-1
13.560	80	NX3225SA-13.560M-STD-CSR-1
14.31818	80	NX3225SA-14.31818M-STD-CSR-1
16.000	80	NX3225SA-16.000M-STD-CSR-1
16.384	80	NX3225SA-16.384M-STD-CSR-1
18.432	80	NX3225SA-18.432M-STD-CSR-1
18.870	80	NX3225SA-18.870M-STD-CSR-1
20.000	50	NX3225SA-20.000M-STD-CSR-1
22.000	50	NX3225SA-22.000M-STD-CSR-1
22.5792	50	NX3225SA-22.5792M-STD-CSR-1
24.000	50	NX3225SA-24.000M-STD-CSR-1
24.576	50	NX3225SA-24.576M-STD-CSR-1
25.000	50	NX3225SA-25.000M-STD-CSR-1
26.000	50	NX3225SA-26.000M-STD-CSR-1
27.000	50	NX3225SA-27.000M-STD-CSR-1
27.120	50	NX3225SA-27.120M-STD-CSR-1
28.63636	50	NX3225SA-28.63636M-STD-CSR-1
30.000	50	NX3225SA-30.000M-STD-CSR-1
32.000	50	NX3225SA-32.000M-STD-CSR-1
36.000	50	NX3225SA-36.000M-STD-CSR-1
40.000	50	NX3225SA-40.000M-STD-CSR-1
44.000	50	NX3225SA-44.000M-STD-CSR-1
48.000	50	NX3225SA-48.000M-STD-CSR-1
54.000	50	NX3225SA-54.000M-STD-CSR-1

Looking for pricing, stock, or lifecycle information?

Click below to explore more details on WIN SOURCE:

-  [View NX3225SA-25.000MHZ-STD-CSR-1 on WIN SOURCE](#)
-  [NDK Information](#)

Optimize Your Supply Chain with WIN SOURCE Solutions

-  Global Sourcing Solution
-  Obsolete Management
-  Cost Control Management
-  Shortage Management
-  Alternative Solution
-  Excess Inventory Management