

NEW

Micro-Miniature Interface Connectors For Power Supply/Signaling

MQ172 Series

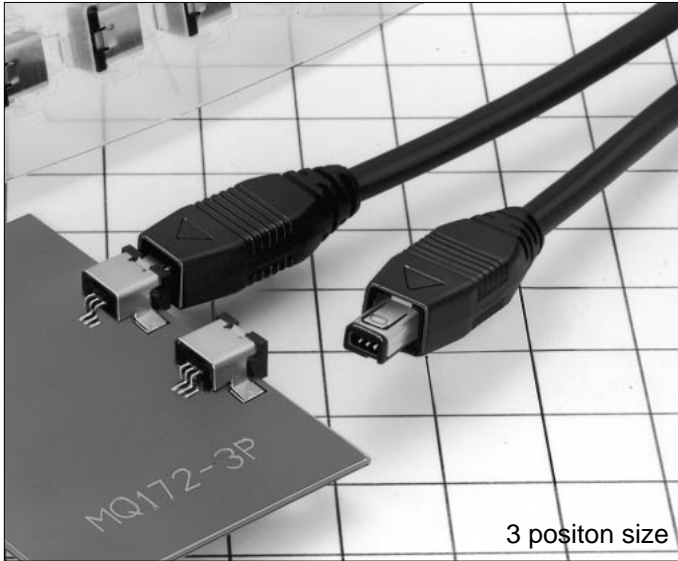

3 position size

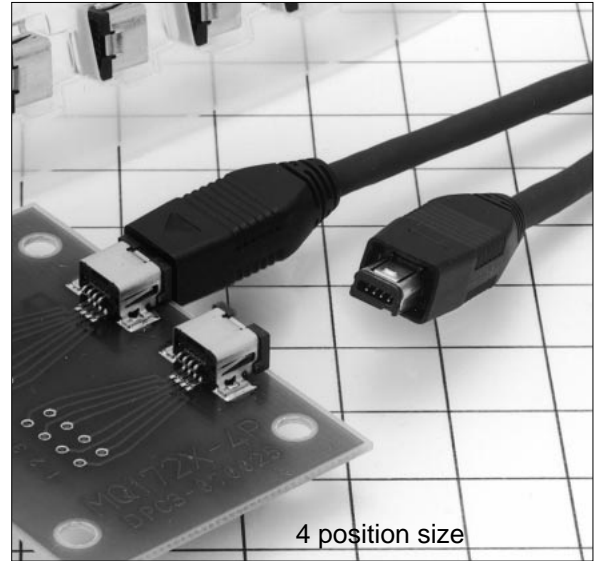

4 position size

■ Features

1. Ultra Miniature/Low Profile SMT Design

With dimensions of 3.9mm(H) x 6.4mm (W) x 6mm (D) for the 3 contact type, this series is ideal for today's miniature, lightweight electronic products.

2. Automatic Mounting:

SMT receptacles are packaged in embossed tape and reel for automatic pick and place installation.

3. Reliable contact:

The 2-point contact design and lead construction provide a contact which is resistant to vibration and shocks.

4. High current capacity:

Unique contact design ensures high current capacity (e.g., 3A for 3-position), small as it is.

5. Positive Locking

Use of a snap-lock system provides the sensation of locking at the time of insertion.

6. Wide variety of suitable cables:

A wide selection of cable types can be utilized since the plug is of the soldered wiring type.

Additionally, the plug case and cord bushing are integrated into a one piece body, allowing for easy assembly by simply pressing the case into place after the harness work.

6. Keys for preventing incorrect insertion:

Both 3 and 4-contact types have keys to prevent incorrect insertion.

■ Applications

Portable remote terminals, portable telephones, PHS(personal handy phone system), Notebook PCs, Electronic measuring instruments, etc.

Space saving
[3 Position type]

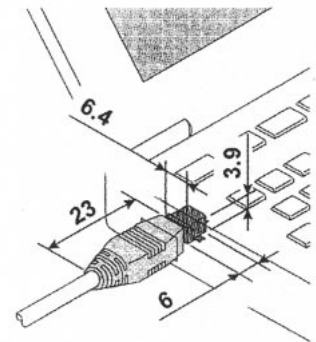

Applications

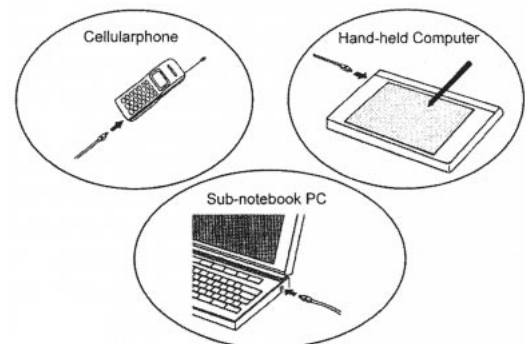

■Product Specifications

RATINGS	Rated Current: 3A (Note.1)	Applicable Temperature Range: -30°C - +75°C
	Rated Voltage: DC 30V or less AC 40V or less	

DESCRIPTION	SPECIFICATIONS	REQUIREMENTS	
1. Insulation resistance	1000MΩ or more	Should be measured at DC 100V.	
2. Voltage resistance	No flashover/dielectric Breakdown	Should be powered at AC 250V for 1 minute.	
3. Contact resistance	30mΩ or less	Measured at 10mA.	
4. Vibration resistance	No instantaneous electric Disconnection of 1μsec or more	10~55Hz, one-sided amplitude 0.75mm, 3 directions for 2 hours, respectively	
5. Humidity resistance	Contact resistance: 50mΩ or less Insulation resistance: 10MΩ or more	Leave under the condition of 40±2°C in temperature and of 90-95% in humidity for 96 hours.	
6. Temperature cycle	Contact resistance: 50mΩ or less Insulation resistance: 1000MΩ or more	(-55°C: 30 minutes → 15-35°C: max. 5 minutes → 85°C: 30 minutes → 15-35°C: max. 5 minutes) 5 cycles	
7. Plugging/ unplugging life	Contact resistance: 50mΩ or less	5,000 times	
8. Heat resistance of soldering	No fusion of resin section affecting performance	SMT type	reflow: at recommended temp. profile
		manual soldering (receptacle and plug)	Temperature of soldering iron: 350°C 3 sec.

(Note.1) For 4-contact type, rated current is 2A, or 3A for optional 2 terminals and 0.5A for other 2 terminals.

(Note.2) Above-stated specifications are typical of this series. For respective formal contract, please refer to "Delivery Specifications".

■Material Quality

Parts	Material	Processing	Remarks
Dielectric	Synthetic resin	Black color	UL94V-0
Terminal	Phosphor bronze	Engagement area...Gold plating of 0.2μm Lead section...Solder-plating	
Cover case(plug)	Synthetic resin	Black color	UL94V-0
Metal fittings(receptacle)	Stainless steel		
Lock case(plug)	Stainless steel		

■Product Number Configuration

This is available for you to determine the product specifications from its format.

When ordering, please select any one among all formats shown in page 3-4 of this catalog.

●RECEPTACLE

MQ172 X - 4 P A (11)

① ② ③ ④ ⑤ ⑥

●PLUG

MQ172 X - 4 S A - CV

① ② ③ ④ ⑤ ⑦

①	Series name: MQ172
②	Series configuration symbol: none...unshielded type X ...shielded type
③	Number of contacts: 3, 4
④	Connector type: P...receptacle S...plug
⑤	Key type symbol: A (only for A type)
⑥	Packing type: none...tray-based packing (11)...embossed tape packing
⑦	Cover case type: CV...standard product (color: black)

■Plugs

●3-Position type

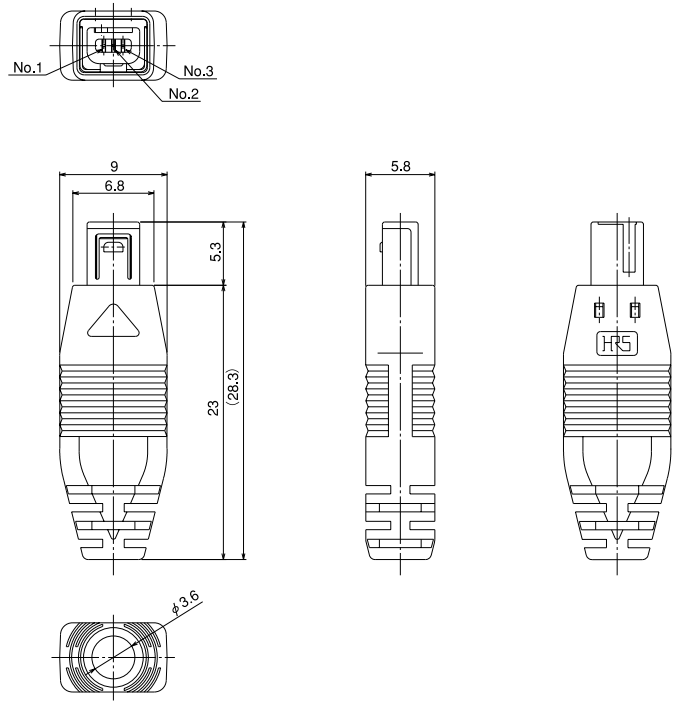
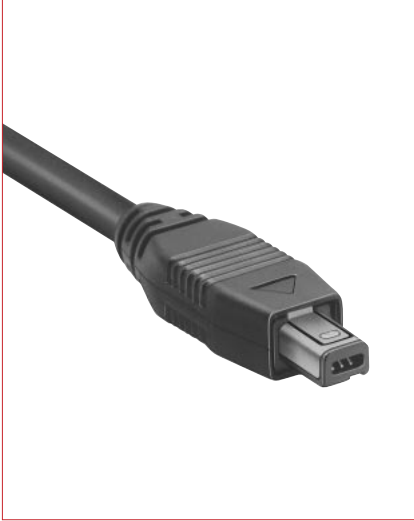

Parts No.	HRS No.
MQ172-3SA-CV	CL206-0951-7

●4-Position type

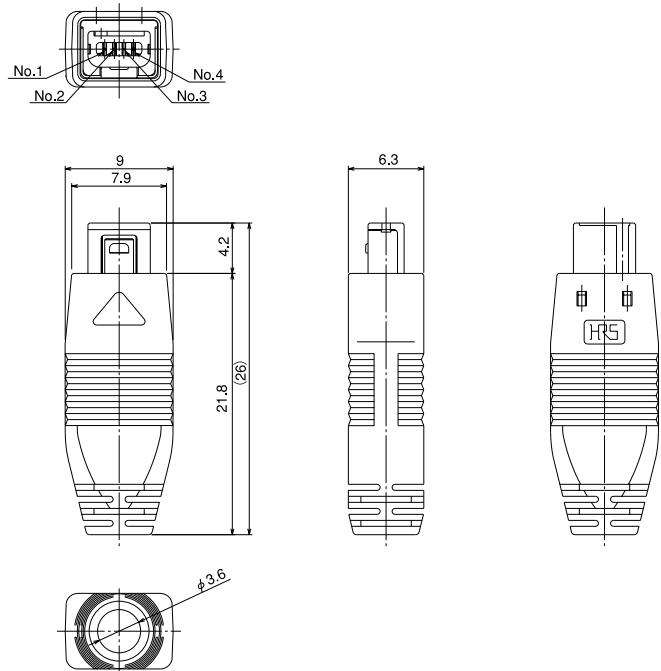
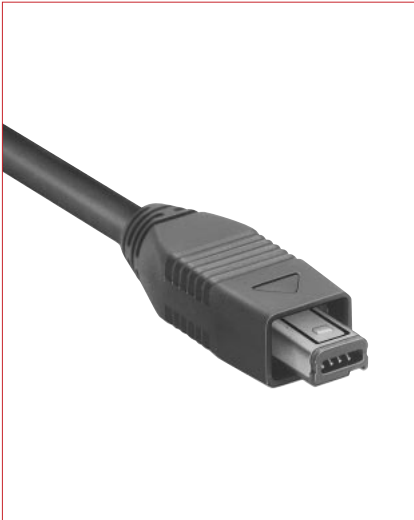

Parts No.	HRS No.
MQ172X-4SA-CV	CL206-2001-9

■Harness Tool

Tool name	Parts No.	HRS No.	Parts name of adaptive plugs	Adaptive cable
Cable caulking jig	MQ172-3S/CK-MP	CL902-2069-4	MQ172-3SA-CV	Outside diameter:φ3.5
	MQ172-4S/CK-MP	CL902-2070-3	MQ172X-4SA-CV	AWG#24-#32

(Note.) As the crimp height after crimping depends on cable type, please consult factory about your designated cable.

Receptacles

●3-Position type

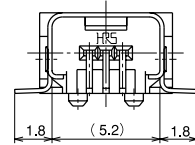
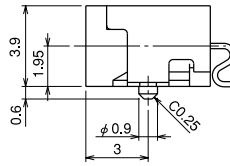
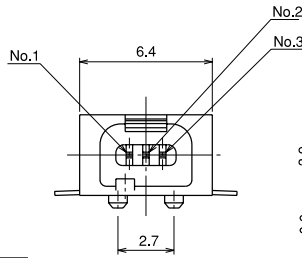
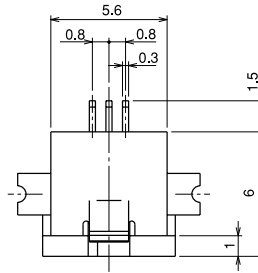

Parts No.	HRS No.
MQ172-3PA-(**)	CL206-0950-4(**)

** none : tray-based packing
 11 : embossed tape packing
 (1 reel = 1,000 roles)

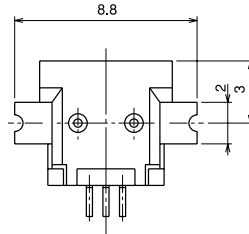

◆ Illustration Of Receptacle Set Installed

(Note.) For MQ172, mounting to circuit boards is SMT type.
 For the purpose of more adequate fixing against external force, it is desirable to affix the entire set after setting as shown in the figure above.

●4-Position type

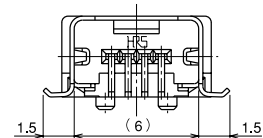
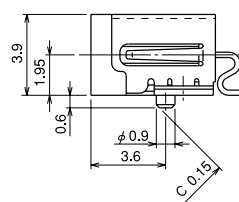
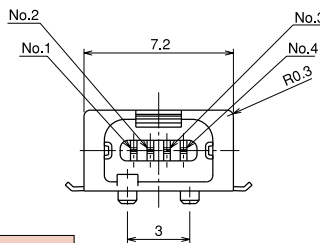
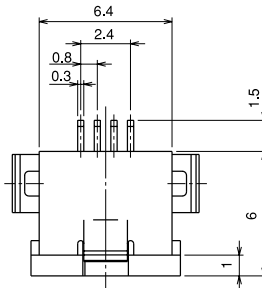

Parts No.	HRS No.
MQ172X-4PA-(**)	CL206-2000-6(**)

** none : tray-based packing
 11 : embossed tape packing
 (1 reel = 1,000 roles)

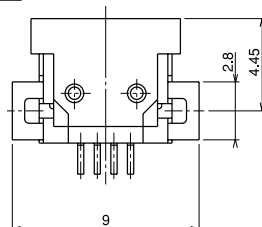

◆ Recommended Land Pattern Dimensions Diagram

●3-Position type

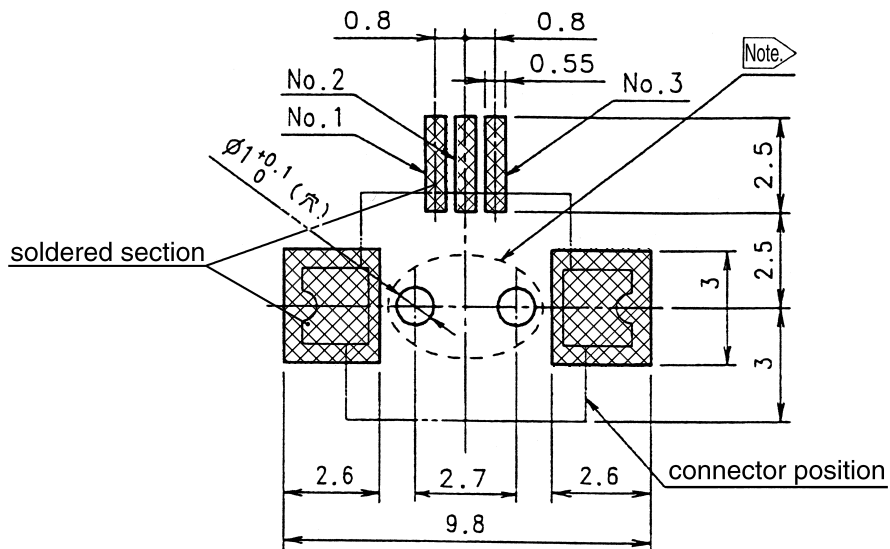

●4-Position type

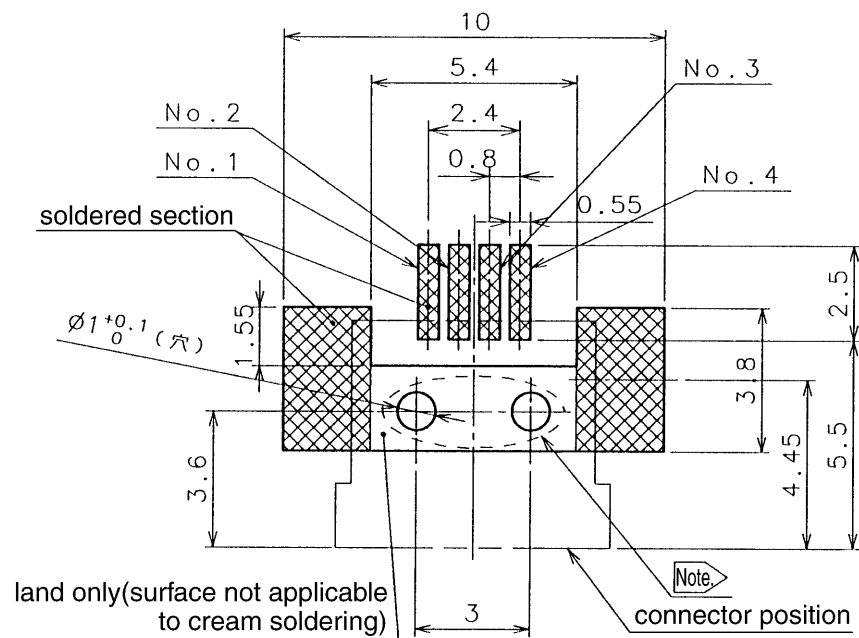

Note.) Mounting of this product to circuit boards is the SMT type.

To provide more adequate fixing, use of adhesive for board-installed area is recommended.

◆ Embossed Tape Carrier Dimensions Diagram (JIS-C-0806 dependent)

● Carrier Dimensions Diagram

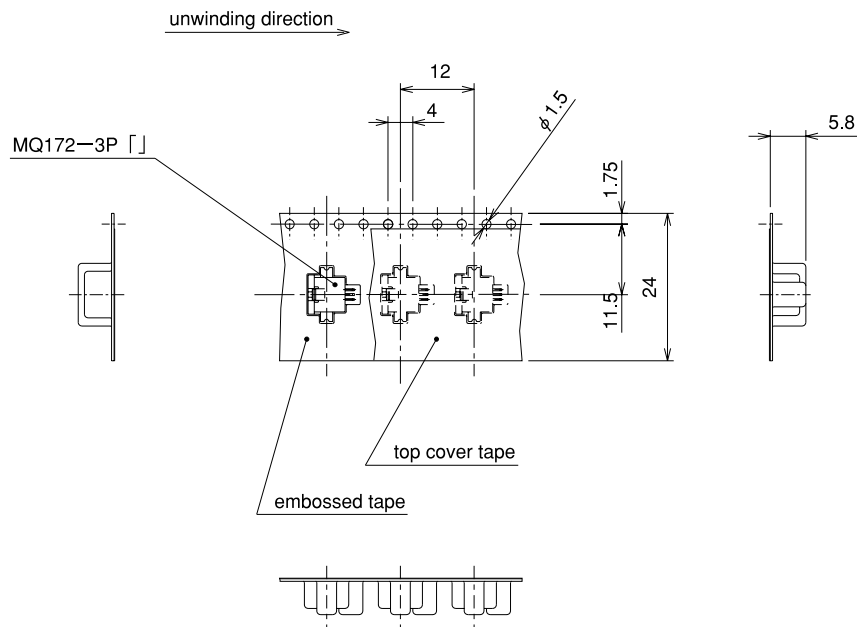

(Note.) The figure above provides the case of a 3 contact type, dimensions shown in such figure are the same as those of a 4 contact type.

● Reel Status Diagram

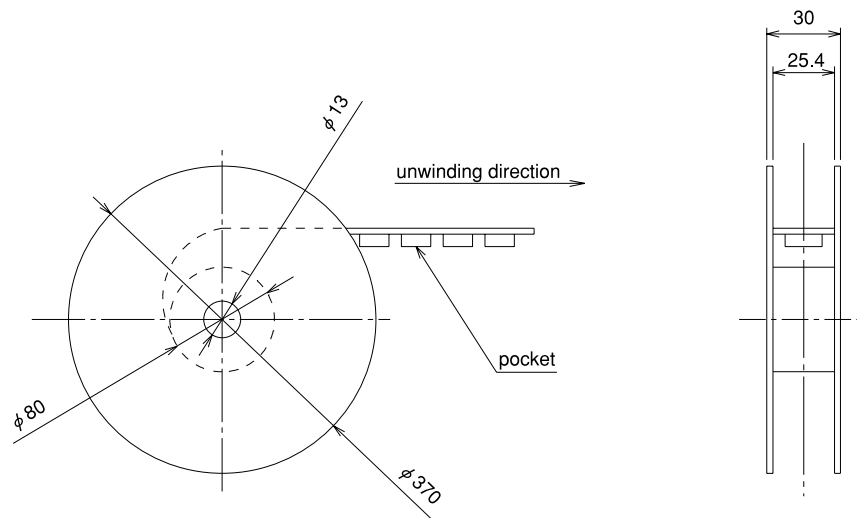

◆ Recommended Temperature Profile

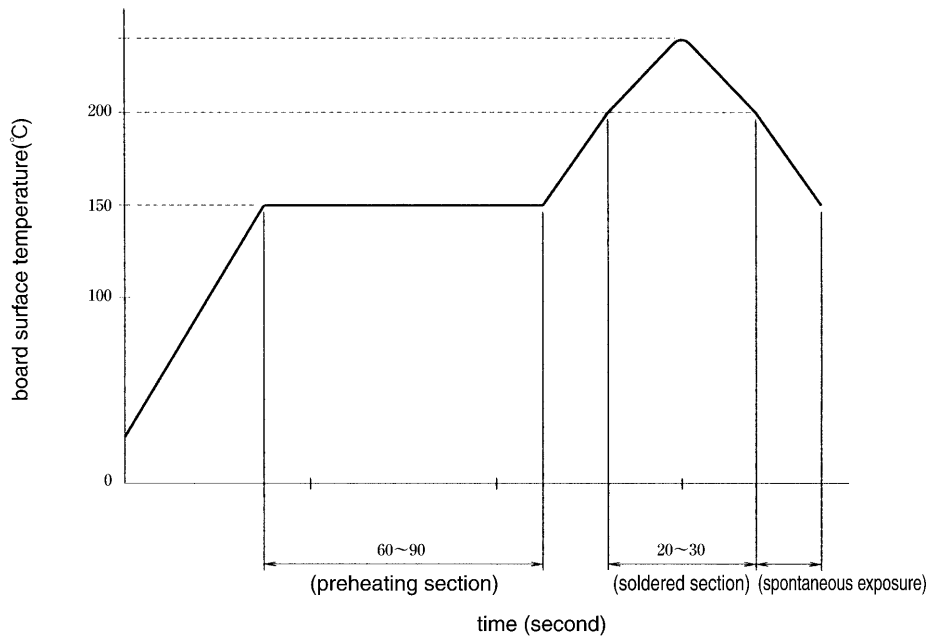

(soldering requirements)

● Board

Dimensions: 50X33X0.8(mm)

Material: glass epoxy

● Cream soldering

Composition: 63Sn/37Pb

(flux content: 10Wt%)

Metal mask thickness: 0.15mm

● Reflow method

IR reflow

● Measurement spot of setting temperature

Housing (mold) surface

◆ Cleaning Requirements

(1) Organic solvent-based cleaning

Solvent	Normal temp.	Heating
IPA (Isopropyl Alcohol)	YES	YES
HCFC (Hydro-chloro-fluoric carbon)	YES	YES

(2) Water-based cleaning

When using water-based detergent (e.g., terpene or alkali saponifier, etc.), select appropriate detergent on the basis of those lists describing effects on metals/resins issued by each detergent manufacturer.

Further be careful not to leave any moisture.

(3) Cautions on cleaning

In cleaning with organic solvent or water-based detergent, residual flux or detergent on the connector may cause excessive degradation of electrical performance. Check fully that reliable cleaning is provided.

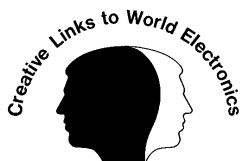

HIROSE ELECTRIC CO.,LTD.

5-23,OSAKI 5-CHOME,SHINAGAWA-KU,TOKYO 141-8586,JAPAN

PHONE:3-3491-9741







FAX :3-3493-2933

Looking for pricing, stock, or lifecycle information?

Click below to explore more details on WIN SOURCE:

-  [View MQ172X-4SA-CV\(50\) on WIN SOURCE](#)
-  [Hirose Electric Co Ltd Information](#)

Optimize Your Supply Chain with WIN SOURCE Solutions

-  Global Sourcing Solution
-  Obsolete Management
-  Cost Control Management
-  Shortage Management
-  Alternative Solution
-  Excess Inventory Management