



**THE DATASHEET OF
MPQ5073GG-AEC1-Z**



DESCRIPTION

The MPQ5073 is a load switch to provide 2A load protection covering 0.5V to 5.5V voltage range. With the small $R_{DS(ON)}$ in tiny packages, MPQ5073 provides very high efficient and space saving solution in notebook and tablet or other portable devices application.

With the soft start function, the MPQ5073 can avoid inrush current during circuit start up. MPQ5073 also provides programmable soft start time, output discharge functions, OCP and thermal shutdown features.

The max load at the output (source) is current limited. This is accomplished by utilizing a sense FET topology.

The magnitude of the current limit is controlled by an external resistor from the ILIM pin to ground.

An internal charge pump drives the gate of the power device, allowing a very low on-resistance DMOS power FET of just 50m Ω .

Tiny QFN-12 (2mmx2mm) of MPQ5073 is available in space saving package.

FEATURES

- Guaranteed Industrial/Automotive Temp Range Limits
- Large V_{IN} Range from 0.5V to 5.5V
- <5 μ A Shutdown Current
- Integrated 50m Ω Low $R_{DS(ON)}$ FETs
- Typical 2A Load Current Range
- Push Pull PG Indicator
- Adjustable Start Up Slew Rate
- Output discharge function
- <200ns Short-Circuitry Response Protection
- Thermal Protection
- Small QFN-12 (2mmx2mm) Package for Space Saving
- Available in AEC-Q100 Qualified Grade

APPLICATIONS

- Notebook and Tablet Computers
- Portable Devices
- Solid State Drivers
- Handheld Devices

All MPS parts are lead-free, halogen free, and adhere to the RoHS directive. For MPS green status, please visit MPS website under Quality Assurance. "MPS" and "The Future of Analog IC Technology" are Registered Trademarks of Monolithic Power Systems, Inc.

TYPICAL APPLICATION

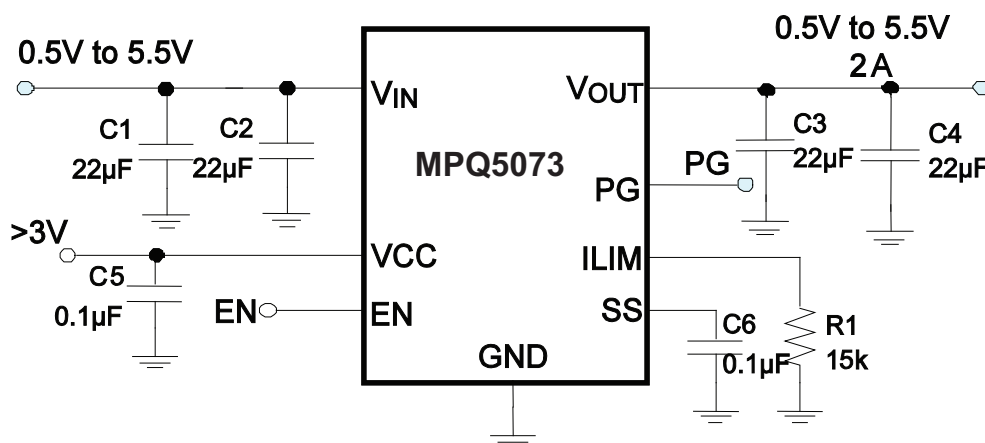

ORDERING INFORMATION

Part Number*	Package	Top Marking
MPQ5073GG	QFN-12 (2mmx2mm)	See Below
MPQ5073GG-AEC1		

* For Tape & Reel, add suffix -Z (e.g. MPQ5073GG-Z);

TOP MARKING

—
CBY
LLL

CB: product code of MPQ5073GG & MPQ5073GG-AEC1;
 Y: year code;
 LLL: lot number;

PACKAGE REFERENCE

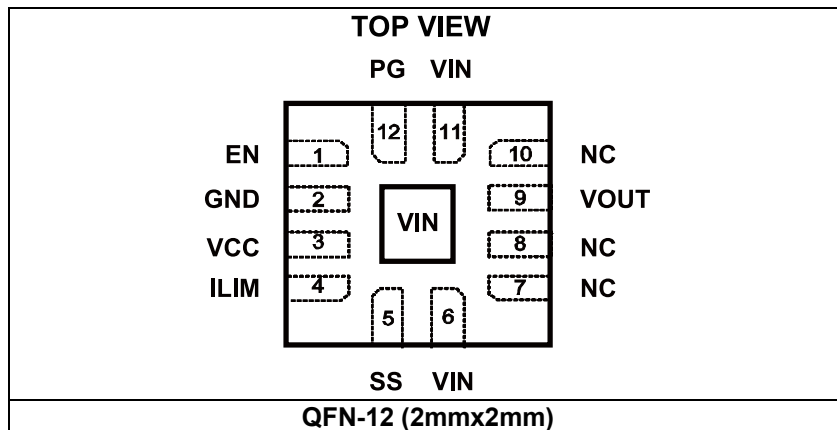

ABSOLUTE MAXIMUM RATINGS ⁽¹⁾

V_{IN}	-0.3V to +6.5V
V_{CC}	-0.3V to +6.5V
V_{OUT}	-0.3V to +6.5V
EN, SS, ILIM	-0.3V to $V_{CC}+0.3V$
Junction Temperature.....	150°C
Lead Temperature	260°C
Continuous Power Dissipation ⁽²⁾	
QFN-12 (2mmx2mm).....	1.6W

Recommended Operating Conditions ⁽³⁾

Supply Voltage V_{IN}	0.5V to 5.5V
Supply Voltage V_{CC}	3V to 5.5V
Output Voltage V_{OUT}	0.5V to 5.5V
Operating Junction Temp	-40°C to +125°C

Thermal Resistance ⁽⁴⁾	θ_{JA}	θ_{JC}
QFN-12 (2mmx2mm)	80	16 °C/W

Notes:

- Exceeding these ratings may damage the device.
- The maximum allowable power dissipation is a function of the maximum junction temperature T_J (MAX), the junction-to-ambient thermal resistance θ_{JA} , and the ambient temperature T_A . The maximum allowable continuous power dissipation at any ambient temperature is calculated by P_D (MAX) = $(T_J$ (MAX) - T_A) / θ_{JA} . Exceeding the maximum allowable power dissipation will cause excessive die temperature, and the device will go into thermal shutdown. Internal thermal shutdown circuitry protects the device from permanent damage.
- The device is not guaranteed to function outside of its operating conditions.
- Measured on JESD51-7, 4-layer PCB.

ELECTRICAL CHARACTERISTICS

$V_{IN} = 3.6V$, $V_{CC} = 3.6V$, $T_J = -40^{\circ}C$ to $+125^{\circ}C$, typical values are $T_J = 25^{\circ}C$, unless otherwise noted.

Parameters	Symbol	Condition	Min	Typ	Max	Units
Input and Supply Voltage Range						
Input Voltage	V_{IN}		0.5		5.5	V
Supply Voltage	V_{CC}		3		5.5	V
Supply Current						
Off State Leakage Current	I_{OFF}	$V_{IN}=5V, EN=0, T_J = 25^{\circ}C$			1	μA
		$V_{IN}=5V, EN=0, -40^{\circ}C < T_J < 125^{\circ}C$			5	μA
V_{CC} Standby Current	I_{STBY}	$V_{CC}=5V, EN=0$		0.1	1	μA
		$V_{CC}=5V, \text{Enable, No Load}$ $T_J = 25^{\circ}C$		180	230	
		$V_{CC} = 5V, \text{Enable, No Load,}$ $-40^{\circ}C < T_J < 125^{\circ}C$		180	250	
Power FET						
ON Resistance	R_{DSON}	$V_{CC} = 5.0V, T_J = 25^{\circ}C$		50	70	m Ω
		$V_{CC} = 5.0V, -40^{\circ}C < T_J < 125^{\circ}C$		50	80	
		$V_{CC} = 3.3V, T_J = 25^{\circ}C$		60	80	
		$V_{CC} = 3.3V, -40^{\circ}C < T_J < 125^{\circ}C$		60	90	
Thermal Shutdown and Recovery ⁽⁵⁾						
Shutdown Temperature	T_{STD}			150		$^{\circ}C$
Hysteresis	T_{HYS}			30		$^{\circ}C$
Under Voltage Protection						
V_{CC} Under Voltage Lockout Threshold	V_{CC_UVLO}	UVLO Rising Threshold		2.6	2.95	V
UVLO Hysteresis	V_{UVLO_HYS}			200		mV
Soft Start						
SS pull-up Current	I_{SS}	Fixed Slew Rate	4	11	17	μA
Enable						
EN Rising Threshold	V_{ENH}		1.3	1.5	1.7	V
EN Hysteresis	V_{EN_hys}			200		mV
ILIM						
Current Limit	I_{OUT}	$R_{LIM}=24k\Omega$. Ramp I_{OUT} Record Peak Current Limit Value		1.4		A
Discharge Resistance						
Discharge Resistance	R_{DIS}			200		Ω
PG						
Power Good Rising Threshold	V_{PG_R}	Voltage Gap between V_{OUT} and V_{IN}	140	280	450	mV
Power Good Threshold	V_{PG_HYS}			60		mV
Power Good Delay	T_{PG_D}			50		μs
Power Good High	V_{PG_H}	$V_{CC}=3.3V$	3.2			V
Power Good Low	V_{PG_L}	Sink 1mA			0.3	V

Notes:

5) Guarantee by design.

PIN FUNCTIONS

QFN-12 (2mmx2mm) Pin #	Name	Description
1	EN	Enable Input. Pulling this pin below the specified threshold shuts the chip down.
2	GND	Ground.
3	VCC	Supply Voltage to the Control Circuitry.
4	ILIM	Output Current Limit Configure. Place a resistor to ground to set the overload current limit level.
5	SS	Soft Start Pin. An external capacitor connected to this pin sets the slew rate of the output voltage soft start period.
6, 11, Exposed pad	VIN	Input Power Supply.
9	VOUT	Output to the Load.
12	PG	Power Good Pin. Push-Pull output.
7,8,10	NC	NC Pin, Suggest connecting them with VOUT to improve the thermal performance.

TYPICAL PERFORMANCE CHARACTERISTICS

$V_{IN} = 3.6V$, $V_{CC} = 3.6V$, $R_{LIM} = 13k\Omega$, $T_A = 25^\circ C$, unless otherwise noted.

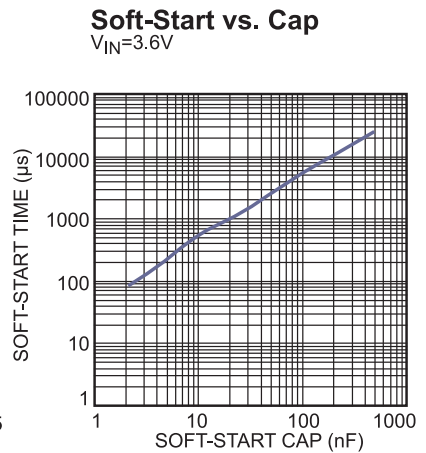
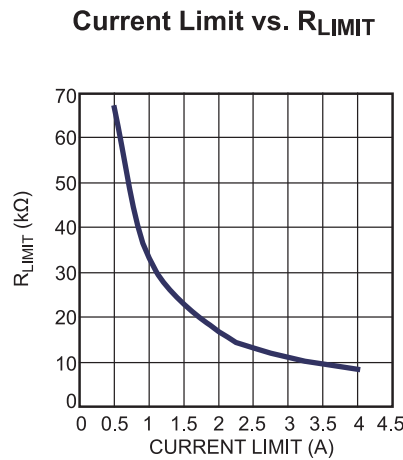
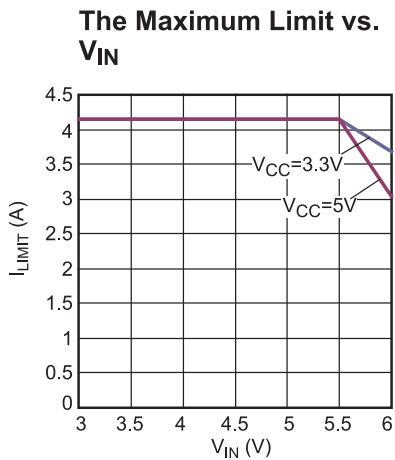
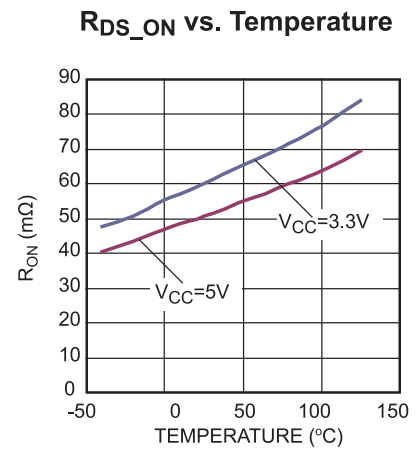
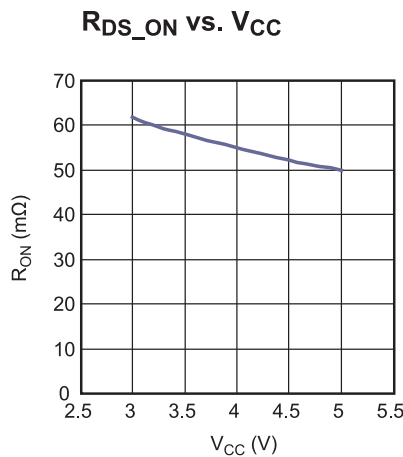
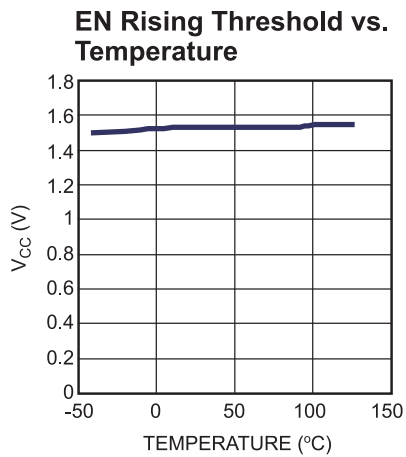
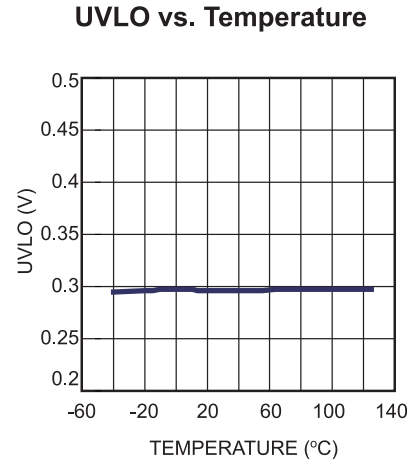
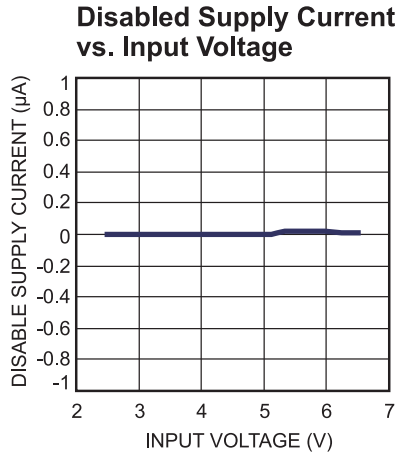
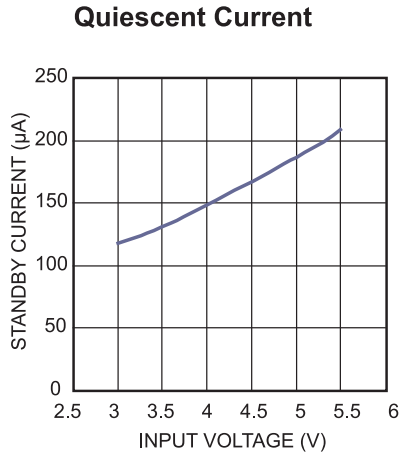

TYPICAL PERFORMANCE CHARACTERISTICS (continued)

$V_{IN} = 3.6V$, $V_{CC} = 3.6V$, $R_{LIM} = 13k\Omega$, $T_A = 25^\circ C$, unless otherwise noted.

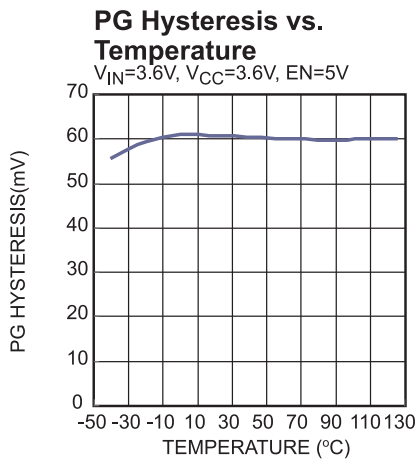
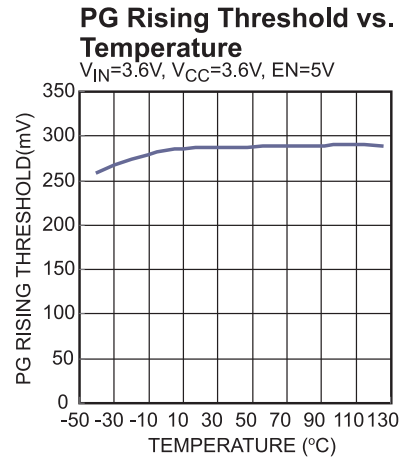
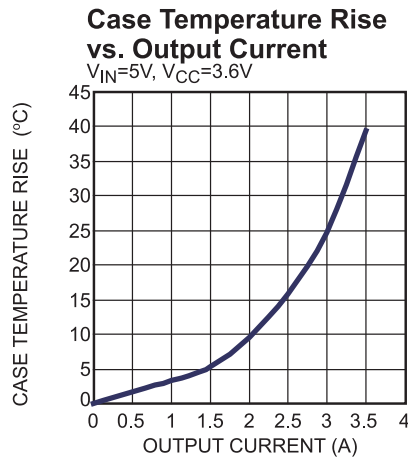
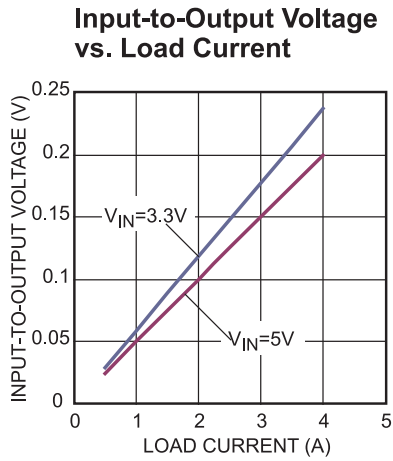

TYPICAL PERFORMANCE CHARACTERISTICS *(continued)*

$V_{IN} = 3.6V$, $V_{CC} = 3.6V$, $EN=4V$, $R_{ILIM} = 13k\Omega$, $T_A = 25^\circ C$, unless otherwise noted.

Enable Startup

$V_{IN} = 5V$, $V_{CC} = 3.6V$, No Load

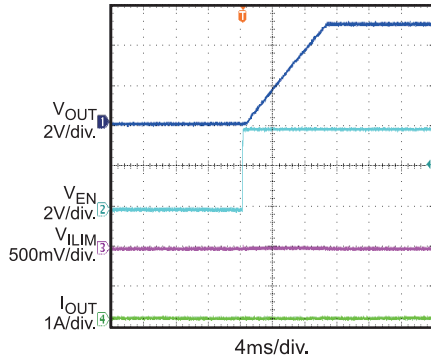

Enable Startup

$V_{IN} = 5V$, $V_{CC} = 3.6V$, 2.5A Load

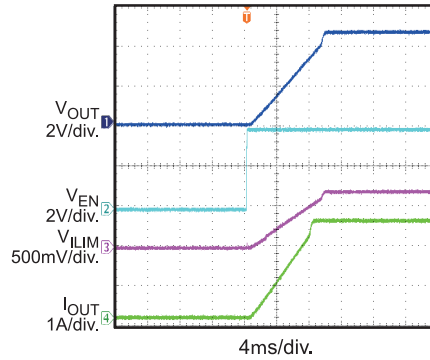

Enable Shutdown

$V_{IN} = 5V$, $V_{CC} = 3.6V$, No Load

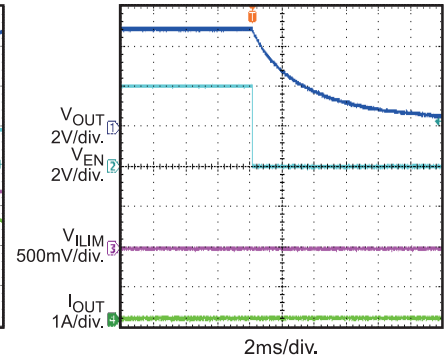

Enable Shutdown

$V_{IN} = 5V$, $V_{CC} = 3.6V$, 2.5A Load

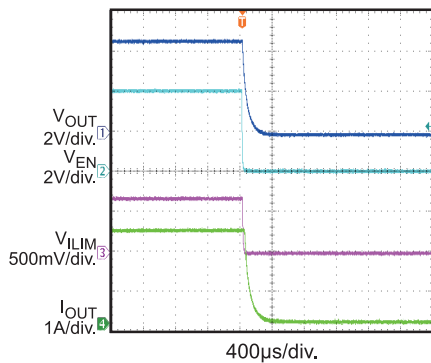

Power Up

$V_{IN} = 5V$, $V_{CC} = 3.6V$, $I_{OUT} = 0A$

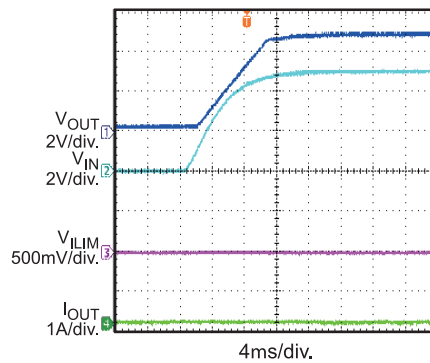

Power Up

$V_{IN} = 5V$, $V_{CC} = 3.6V$, $I_{OUT} = 2.5A$

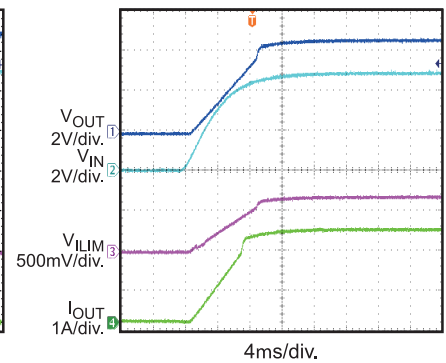

Power Down

$V_{IN} = 5V$, $V_{CC} = 3.6V$, $I_{OUT} = 0A$

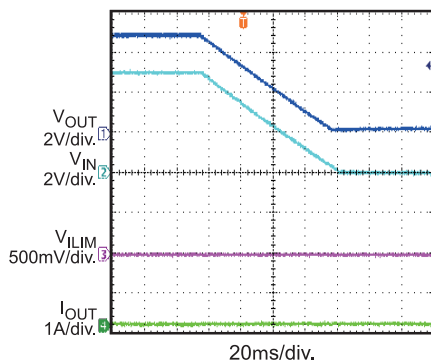

Power Down

$V_{IN} = 5V$, $V_{CC} = 3.6V$, $I_{OUT} = 2.5A$

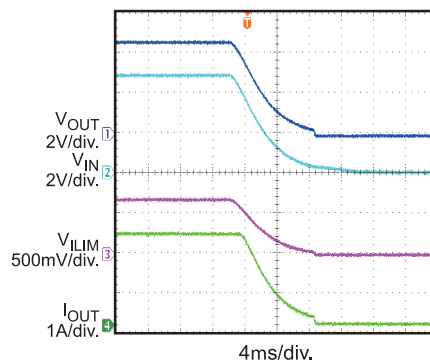

Steady State

$V_{IN} = 5V$, $V_{CC} = 3.6V$, $I_{OUT} = 2A$

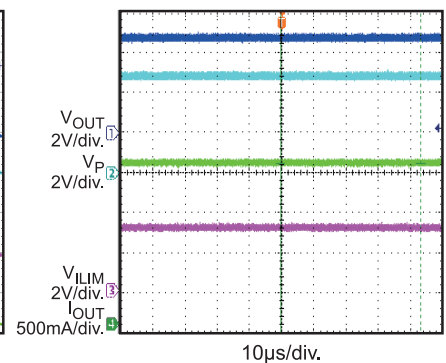

TYPICAL PERFORMANCE CHARACTERISTICS *(continued)*

$V_{IN} = 3.6V$, $V_{CC} = 3.6V$, $EN=4V$, $R_{ILIM} = 13k\Omega$, $T_A = 25^\circ C$, unless otherwise noted.

Load Transient Response

$V_{IN} = 3.6V$, $V_{CC} = 3.6V$, $I_{OUT} = 0A-2.5A$

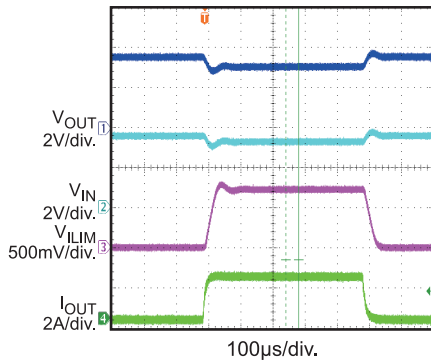

SCP Enter

$V_{IN} = 5V$, $V_{CC} = 3.6V$

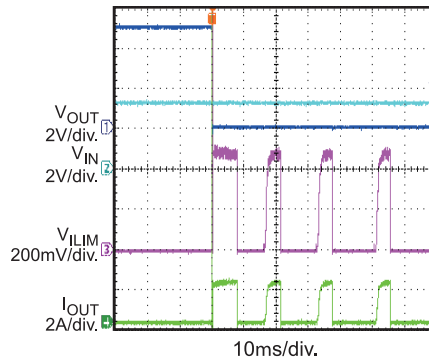

SCP Steady State

$V_{IN} = 5V$, $V_{CC} = 3.6V$

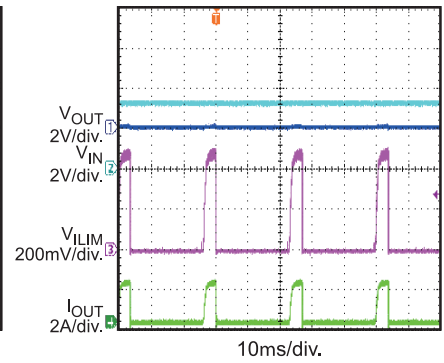

SCP Recovery

$V_{IN} = 5V$, $V_{CC} = 3.6V$

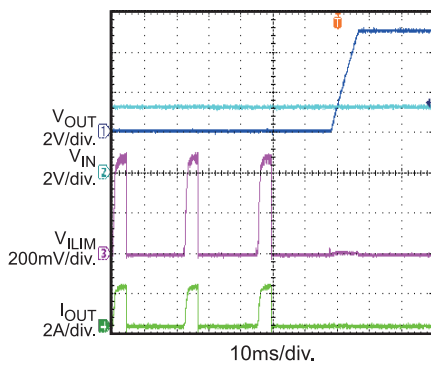

OPERATION

The MPQ5073 is designed to limit the in-rush current to the load when a circuit card is inserted into a live backplane power source; thereby limiting the backplane's voltage drop and the slew rate of the voltage to the load. It provides an integrated solution to monitor the input voltage, output voltage and output current to eliminate the need for an external current power MOSFET, and current sense device.

Enable

When input voltage is greater than the under-voltage lockout threshold (UVLO), typically 0.5V, MPQ5073 can be enabled by pulling EN pin to higher than 1.5V. Pulling down to ground will disable MPQ5073.

Current Limit

The MPQ5073 provides a constant current limit that can be programmed by an external resistor. Once the device reaches its current limit threshold, the internal circuit regulates the gate voltage to hold the current in the power FET constant. The typical response time is about 20µs and the output current may have a small overshoot during this time period.

The pre-set current limit value can be calculated by below equation:

$$I_{Limit} = (1 \div R_{ILIM}) \times S \quad (1)$$

S is the current sense ratio of MPQ5073, and this value is typically 33000 in $V_{IN}=3.6V$.

If the current limit block starts to regulate the output current, the power loss on power MOSFET will cause the IC temperature rise. If the junction temperature rose to high enough, it will trigger thermal shutdown. After thermal shutdown happened, it will disable the output until the over temperature fault remove. The over temperature threshold is 150°C and hysteresis is 30°C.

Power-Good Function

The PG pin is the push pull of a MOSFET that can be pulled high to V_{CC} . The MOSFET turns on with the application of an input voltage so that the PG pin is pulled to GND. After the voltage gap between V_{IN} and V_{OUT} is smaller

than 280mV, the PG pin is pulled high after a 50µs delay. When the voltage gap is higher than 340mV, the PG pin will be pulled low.

Short-Circuit Protection

If the load current increases rapidly due to a short circuit, the current may exceed the current limit threshold by a lot before the control loop can respond. If the current reaches an internal secondary current limit level (about 7A), a fast turn-off circuit activates to turn off the power FET. This limits the peak current through the switch to limit the input voltage drop. The total short circuit response time is about 200ns. If fast off works, it will keep off the power FET for 80µs. After that time period, it will re-turn on power FET, if the part is still in short-circuit condition. MPQ5073 will reduce the current limit, and hold it until the part is so hot and thermal shutdown. After the short-circuit condition removed, the current limit will recover to the pre-set value automatically.

Output Discharge

MPQ5073 has output discharge function. This function can discharge the V_O by internal pull down resistance when IC disabled and the load is very light.

Soft-Start

A capacitor connected to the SS pin determines the soft-start time. There is an internal 11µA constant current source charge SS cap and ramps up the voltage on the SS pin. The output voltage rises at 5 times the slew rate to the SS voltage.

The soft-start time can be calculated by below equation:

$$T_{SS} (ms) = \frac{1}{5} \times \frac{V_{OUT} (V) \cdot C_{SS} (nF)}{I_{SS} (\mu A)} \quad (2)$$

T_{SS} is the soft-start time, I_{SS} is internal 11µA constant current, C_{SS} is external soft-start cap.

The suggestion minimum SS cap should be bigger than 4.7nF. If the SS pin is floated or SS cap is too small, the V_{OUT} rising time will be just limited by power MOS charge time.

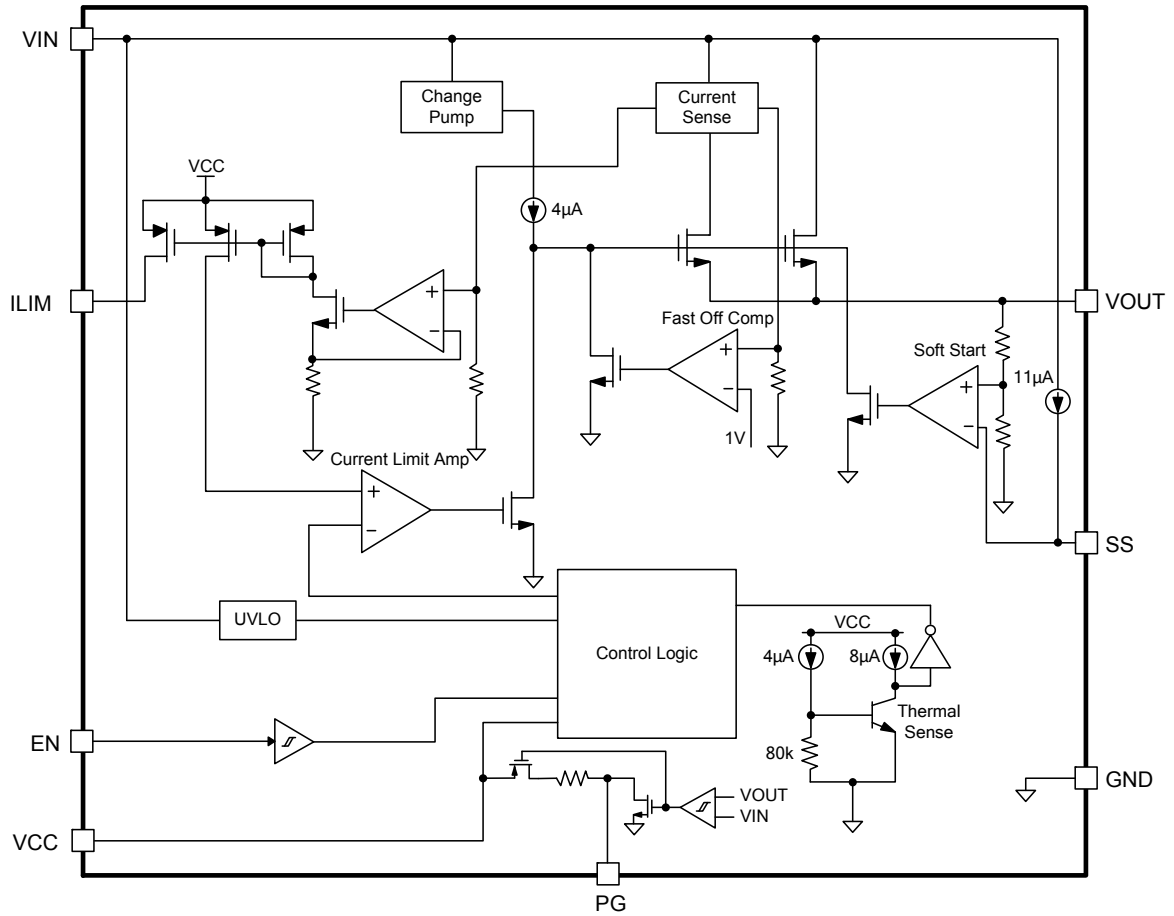

Figure 1: Functional Block Diagram

APPLICATION INFORMATION

ILIM Resistor Selection

The current limit value can be set by ILIM resistor. The current limit can be gotten by equation (1).

The current limit threshold is suggested to 10% ~ 20% higher than maximum load current. For example, if the system’s full load is 2A, set the current limit to 2.2A.

ILIM Capacitor Selection

The internal advanced auto-zero comparator bring a high accuracy of current monitor. The auto-zero will also cause some little jitter on ILIM pin. To get a more stable ILIM, a small ceramic capacitor can be mounted between ILIM and ground. Suggested place an ILIM capacitor less than 1nF.

Soft Start Capacitor Selection

There is an internal 11µA constant current source charge SS cap and ramps up the voltage on the SS pin. The output voltage rises follow the slew rate of SS voltage.

If the inrush on output current reached the current limit during start up (like with large output cap or very large load), MPQ5073 will limit the output current and the same time, SS time will be increased (Fig 2 and Fig 3).

Component Selection

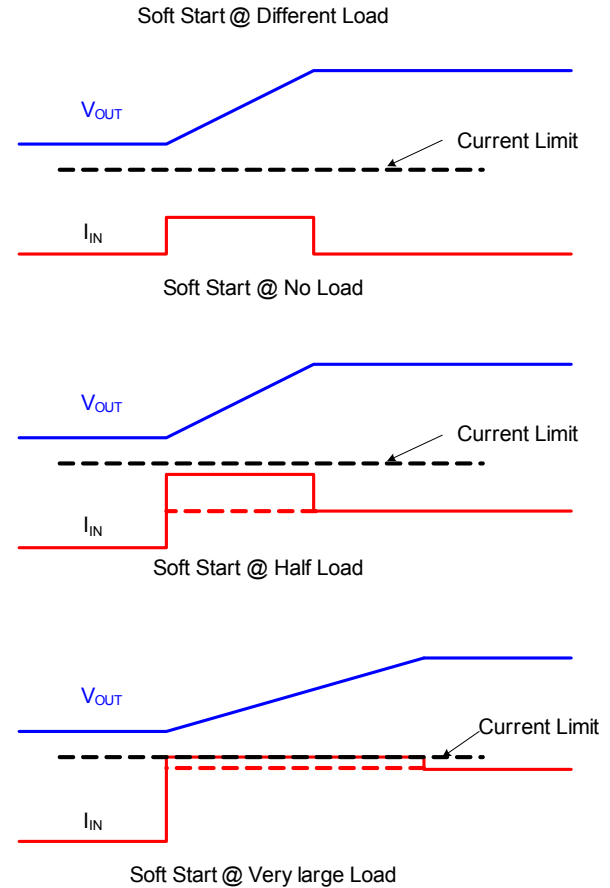

Figure 2: Soft Start Periods at different load

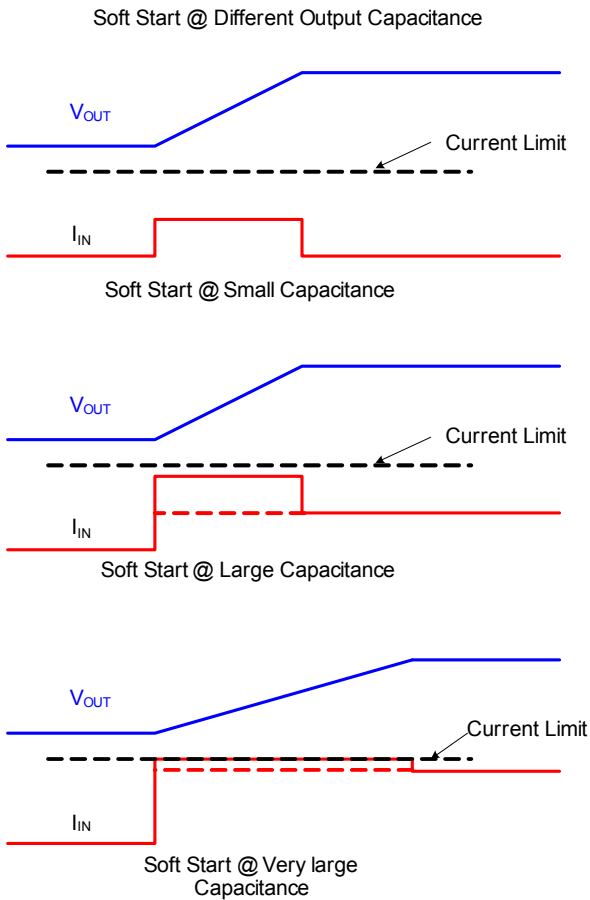

Figure 3: Soft Start Periods at different output capacitance

Design Example

Some design example and are provided below. See Table 1 and Figure 4.

Table 1

V _{IN} (V)	Max Load Range (A)	R _{limit} (kΩ)	SS cap (nF)	SS time (ms)
3.6	0.5	47	22	1
3.6	1	27.4	47	2.4
3.6	2	15	100	5.4

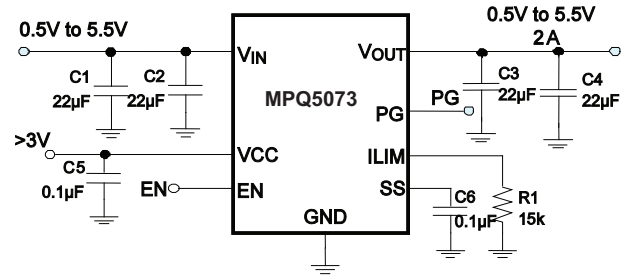

Figure 4: Typical Application Schematic

Layout Guide

PCB layout is very important to achieve stable operation. Please follow these guidelines and take below figure for reference. Place R_{ILIM} close to ILIM pin, input cap close to V_{CC} pin. Put enough vias around IC to achieve better thermal performance.

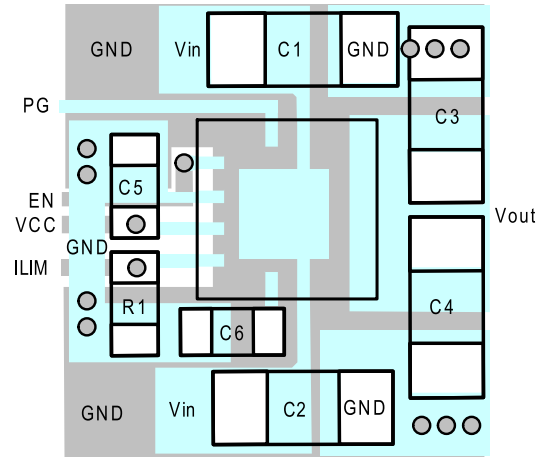
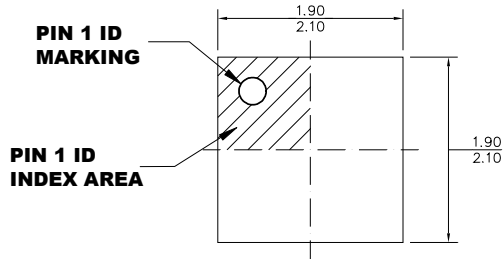

Figure 5: Recommended Layout

PACKAGE INFORMATION

QFN-12 (2mmx2mm)



TOP VIEW

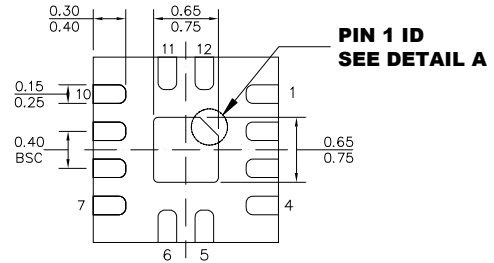

BOTTOM VIEW

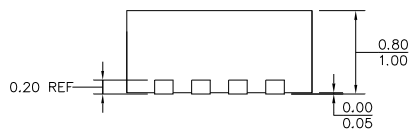

SIDE VIEW

PIN 1 ID OPTION A
0.20x45° TYP.



PIN 1 ID OPTION B
R0.20 TYP.

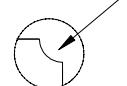

DETAIL A

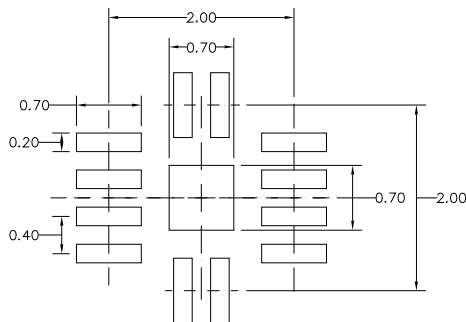

RECOMMENDED LAND PATTERN

NOTE:

- 1) ALL DIMENSIONS ARE IN MILLIMETERS.
- 2) EXPOSED PADDLE SIZE DOES NOT INCLUDE MOLD FLASH.
- 3) LEAD COPLANARITY SHALL BE 0.10 MILLIMETERS MAX.
- 4) JEDEC REFERENCE IS MO-229.
- 5) DRAWING IS NOT TO SCALE.

NOTICE: The information in this document is subject to change without notice. Please contact MPS for current specifications. Users should warrant and guarantee that third party Intellectual Property rights are not infringed upon when integrating MPS products into any application. MPS will not assume any legal responsibility for any said applications.

Looking for pricing, stock, or lifecycle information?

Click below to explore more details on WIN SOURCE:

- ⊖ [View MPQ5073GG-AEC1-Z on WIN SOURCE](#)
- ⊖ [Monolithic Power Systems Inc. Information](#)

Optimize Your Supply Chain with WIN SOURCE Solutions

- ✓ Global Sourcing Solution
- ✓ Obsolete Management
- ✓ Cost Control Management
- ✓ Shortage Management
- ✓ Alternative Solution
- ✓ Excess Inventory Management