



**THE DATASHEET OF
MOC5009SR2M**





6-Pin DIP Optoisolators Logic Output

The MOC5007, MOC5008 and MOC5009 have a gallium arsenide IRED optically coupled to a high-speed integrated detector with Schmitt trigger output. Ideal for applications requiring electrical isolation, fast response time, noise immunity and digital logic compatibility.

- Guaranteed Switching Times — t_{on} , t_{off} $4 < \mu s$
- Built-In ON/OFF Threshold Hysteresis
- High Data Rate, 1 MHz Typical (NRZ)
- Wide Supply Voltage Capability
- Microprocessor Compatible Drive
- **To order devices that are tested and marked per VDE 0884 requirements, the suffix "V" must be included at end of part number. VDE 0884 is a test option.**

Applications

- Interfacing Computer Terminals to Peripheral Equipment
- Digital Control of Power Supplies
- Line Receiver — Eliminates Noise
- Digital Control of Motors and Other Servo Machine Applications
- Logic to Logic Isolator
- Logic Level Shifter — Couples TTL to CMOS

MAXIMUM RATINGS ($T_A = 25^\circ C$ unless otherwise noted)

Rating	Symbol	Value	Unit
INPUT LED			
Reverse Voltage	V_R	6	Volts
Forward Current — Continuous	I_F	60	mA
Peak		1.2	Amp
Pulse Width = 300 μs , 2% Duty Cycle			
LED Power Dissipation @ $T_A = 25^\circ C$	P_D	120	mW
Derate above $25^\circ C$		1.41	mW/ $^\circ C$
OUTPUT DETECTOR			
Output Voltage Range	V_O	0–16	Volts
Supply Voltage Range	V_{CC}	3–16	Volts
Output Current	I_O	50	mA
Detector Power Dissipation @ $T_A = 25^\circ C$	P_D	150	mW
Derate above $25^\circ C$		1.76	mW/ $^\circ C$
TOTAL DEVICE			
Total Device Power Dissipation @ $T_A = 25^\circ C$	P_D	250	mW
Derate above $25^\circ C$		2.94	mW/ $^\circ C$
Maximum Operating Temperature	T_A	–40 to +85	$^\circ C$
Storage Temperature Rang	T_{stg}	–55 to +150	$^\circ C$
Soldering Temperature (10 s)	T_L	260	$^\circ C$
Isolation Surge Voltage ⁽¹⁾ (Peak ac Voltage, 60 Hz, 1 Second Duration)	V_{ISO}	7500	Vac(pk)

1. Isolation surge voltage is an internal device dielectric breakdown rating.
For this test, Pins 1 and 2 are common, and Pins 4, 5 and 6 are common.

MOC5007
MOC5008
MOC5009

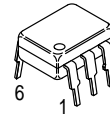

STANDARD THRU HOLE

SCHEMATIC

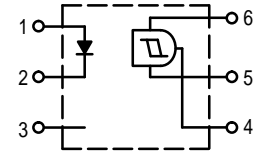

- PIN 1. ANODE
2. CATHODE
3. NC
4. OPEN COLLECTOR
OUTPUT
5. GROUND
6. V_{CC}

ELECTRICAL CHARACTERISTICS ($T_A = 25^\circ\text{C}$ unless otherwise noted)⁽¹⁾

Characteristic	Symbol	Min	Typ ¹⁾	Max	Unit	
INPUT LED						
Reverse Leakage Current ($V_R = 3\text{ V}$, $R_L = 1\text{ M}\Omega$)	I_R	—	0.05	10	μA	
Forward Voltage ($I_F = 10\text{ mA}$) ($I_F = 0.3\text{ mA}$)	V_F	— 0.75	1.2 0.95	1.5 —	Volts	
Capacitance ($V_R = 0\text{ V}$, $f = 1\text{ MHz}$)	C	—	18	—	pF	
OUTPUT DETECTOR						
Operating Voltage	V_{CC}	3	—	15	Volts	
Supply Current ($I_F = 0$, $V_{CC} = 5\text{ V}$)	$I_{CC(\text{off})}$	—	1	5	mA	
Output Current, High ($I_F = 0$, $V_{CC} = V_O = 15\text{ V}$)	I_{OH}	—	—	100	μA	
COUPLED						
Supply Current ($I_F = I_{F(\text{on})}$, $V_{CC} = 5\text{ V}$)	$I_{CC(\text{on})}$	—	1.6	5	mA	
Output Voltage, Low ($R_L = 270\ \Omega$, $V_{CC} = 5\text{ V}$, $I_F = I_{F(\text{on})}$)	V_{OL}	—	0.2	0.4	Volts	
Threshold Current, ON ($R_L = 270\ \Omega$, $V_{CC} = 5\text{ V}$)	$I_{F(\text{on})}$	—	1.2	1.6	mA	
	MOC5007	—	—	4		
	MOC5008	—	—	10		
	MOC5009	—	—	—		
Threshold Current, OFF ($R_L = 270\ \Omega$, $V_{CC} = 5\text{ V}$)	$I_{F(\text{off})}$	0.3	0.75	—	mA	
	MOC5007	0.3	—	—		
	MOC5008, 5009	—	—	—		
Hysteresis Ratio ($R_L = 270\ \Omega$, $V_{CC} = 5\text{ V}$)	$\frac{I_{F(\text{off})}}{I_{F(\text{on})}}$	0.5	0.75	0.9		
Isolation Voltage ⁽²⁾ 60 Hz, AC Peak, 1 second, $T_A = 25^\circ\text{C}$	V_{ISO}	7500	—	—	Vac(pk)	
Turn-On Time	$R_L = 270\ \Omega^{(3)}$ $V_{CC} = 5\text{ V}$, $I_F = I_{F(\text{on})}$ $T_A = 25^\circ\text{C}$	t_{on}	—	1.2	4	μs
Fall Time		t_f	—	0.1	—	
Turn-Off Time		t_{off}	—	1.2	4	
Rise Time		t_r	—	0.1	—	

1. Always design to the specified minimum/maximum electrical limits (where applicable).
2. For this test, IRED Pins 1 and 2 are common and Output Gate Pins 4, 5, 6 are common.
3. R_L value effect on switching time is negligible.

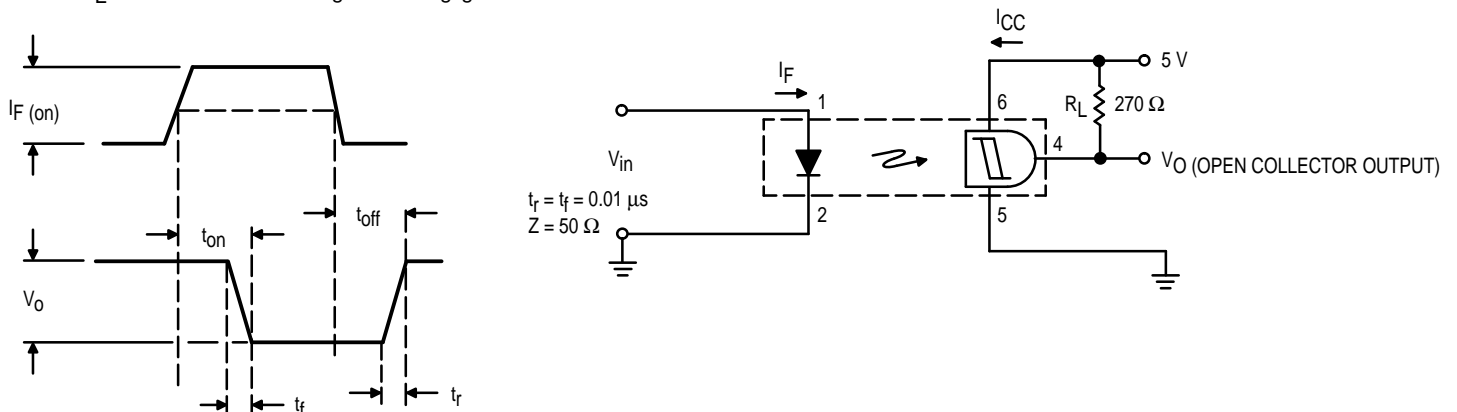

Figure 1. Switching Test Circuit

TYPICAL CHARACTERISTICS

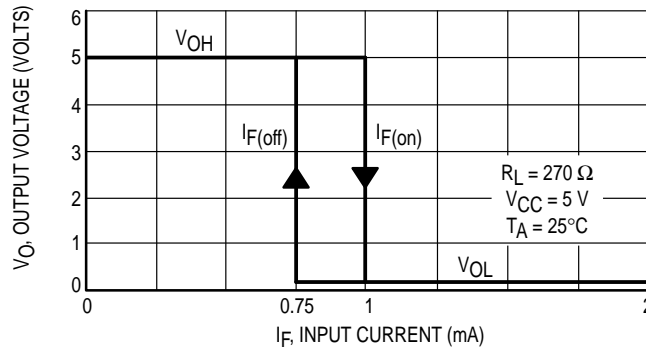

Figure 2. Transfer Characteristics for MOC5007

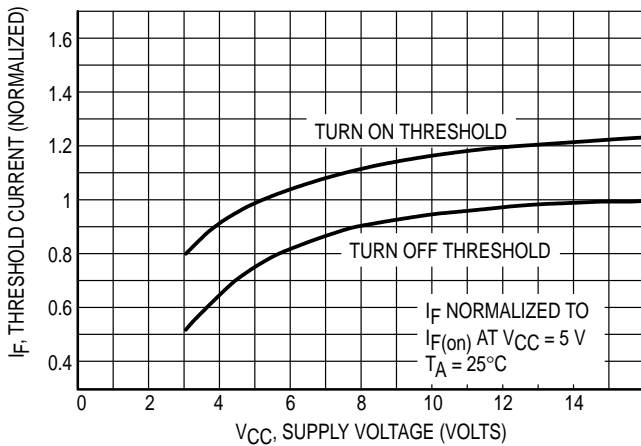

Figure 3. Threshold Current versus Supply Voltage

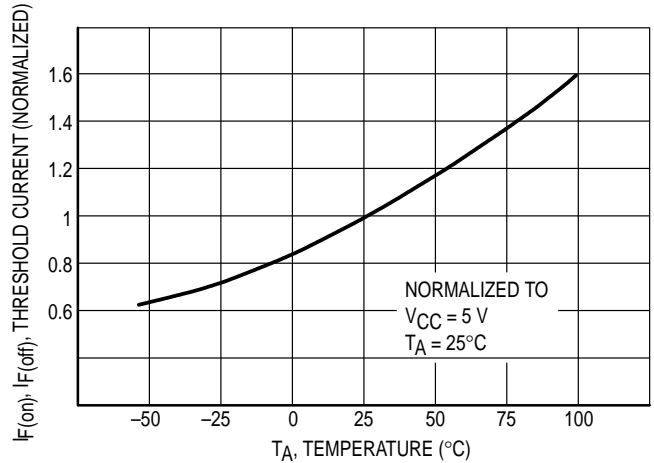

Figure 4. Threshold Current versus Temperature

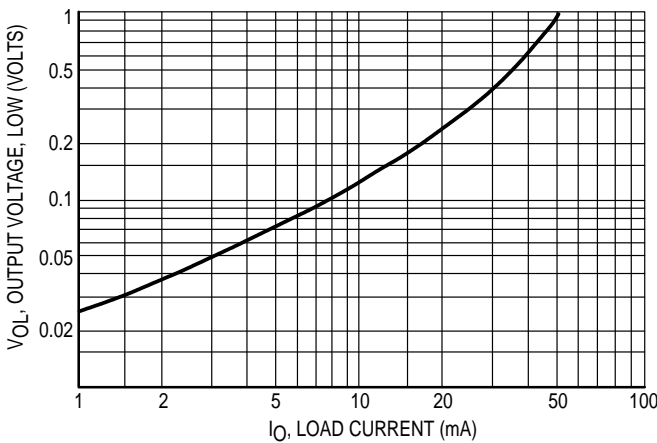

Figure 5. Output Voltage, Low versus Load Current

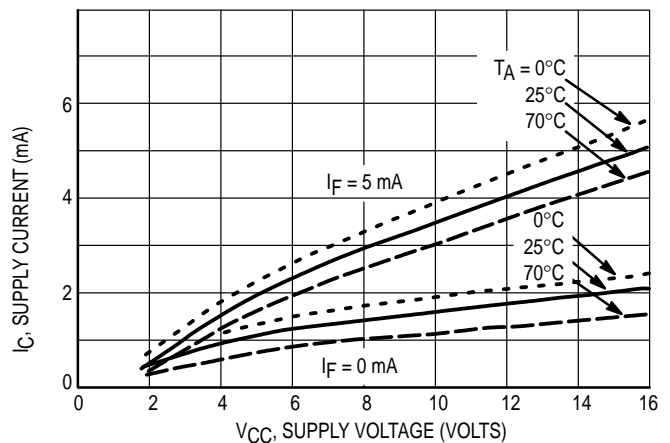
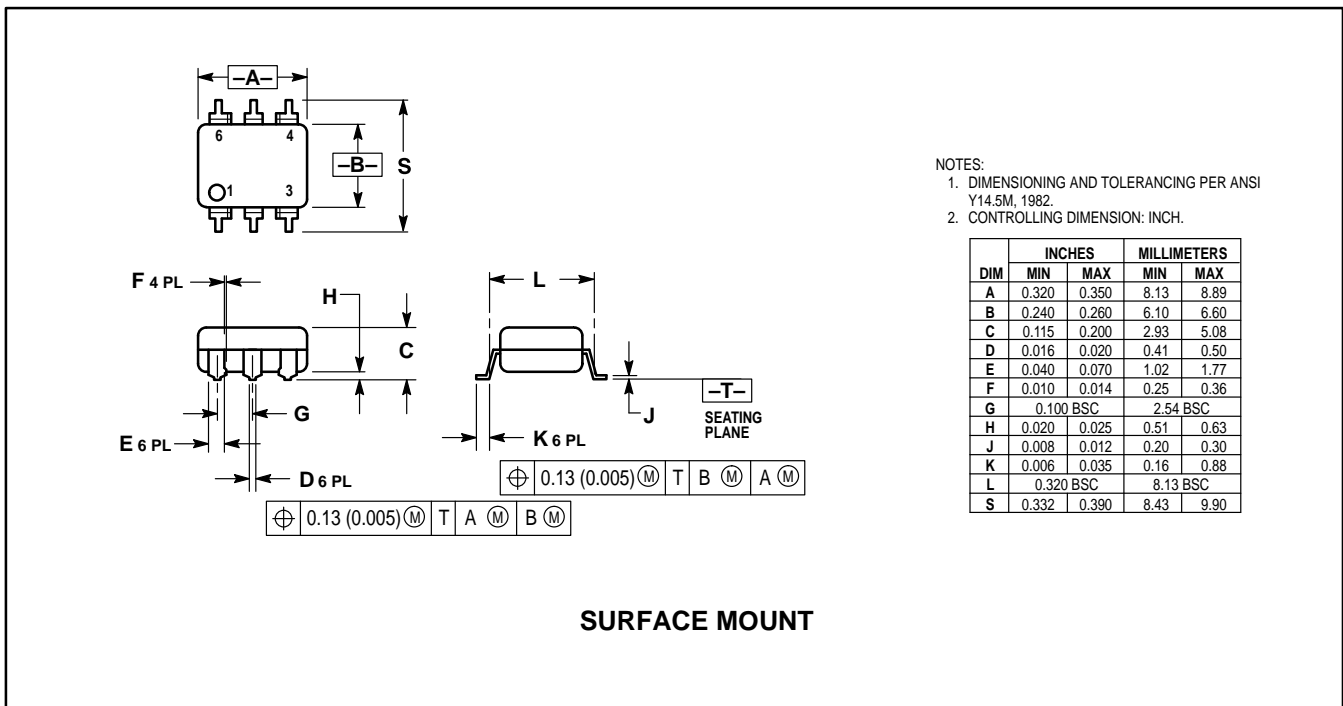
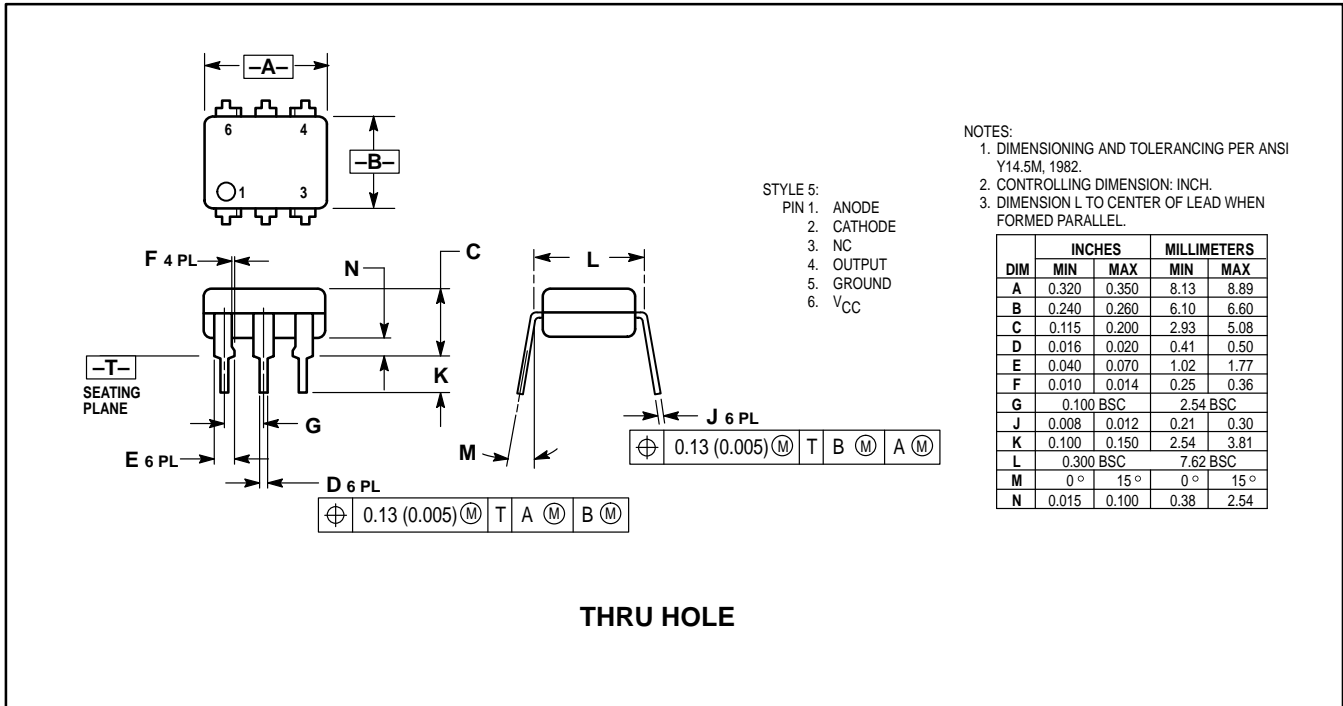
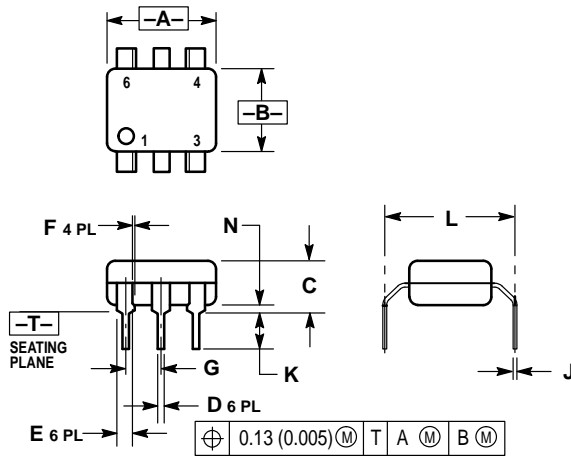

Figure 6. Supply Current versus Supply Voltage

PACKAGE DIMENSIONS





- NOTES:
1. DIMENSIONING AND TOLERANCING PER ANSI Y14.5M, 1982.
 2. CONTROLLING DIMENSION: INCH.
 3. DIMENSION L TO CENTER OF LEAD WHEN FORMED PARALLEL.

DIM	INCHES		MILLIMETERS	
	MIN	MAX	MIN	MAX
A	0.320	0.350	8.13	8.89
B	0.240	0.260	6.10	6.60
C	0.115	0.200	2.93	5.08
D	0.016	0.020	0.41	0.50
E	0.040	0.070	1.02	1.77
F	0.010	0.014	0.25	0.36
G	0.100 BSC		2.54 BSC	
J	0.008	0.012	0.21	0.30
K	0.100	0.150	2.54	3.81
L	0.400	0.425	10.16	10.80
N	0.015	0.040	0.38	1.02

0.4" LEAD SPACING

DISCLAIMER

FAIRCHILD SEMICONDUCTOR RESERVES THE RIGHT TO MAKE CHANGES WITHOUT FURTHER NOTICE TO ANY PRODUCTS HEREIN TO IMPROVE RELIABILITY, FUNCTION OR DESIGN. FAIRCHILD DOES NOT ASSUME ANY LIABILITY ARISING OUT OF THE APPLICATION OR USE OF ANY PRODUCT OR CIRCUIT DESCRIBED HEREIN; NEITHER DOES IT CONVEY ANY LICENSE UNDER ITS PATENT RIGHTS, NOR THE RIGHTS OF OTHERS.

LIFE SUPPORT POLICY

FAIRCHILD'S PRODUCTS ARE NOT AUTHORIZED FOR USE AS CRITICAL COMPONENTS IN LIFE SUPPORT DEVICES OR SYSTEMS WITHOUT THE EXPRESS WRITTEN APPROVAL OF THE PRESIDENT OF FAIRCHILD SEMICONDUCTOR CORPORATION. As used herein:

1. Life support devices or systems are devices or systems which, (a) are intended for surgical implant into the body, or (b) support or sustain life, and (c) whose failure to perform when properly used in accordance with instructions for use provided in the labeling, can be reasonably expected to result in a significant injury of the user.
2. A critical component in any component of a life support device or system whose failure to perform can be reasonably expected to cause the failure of the life support device or system, or to affect its safety or effectiveness.

Looking for pricing, stock, or lifecycle information?

Click below to explore more details on WIN SOURCE:

 [View MOC5009SR2M on WIN SOURCE](#)

 [ON Semiconductor](#) Information

Optimize Your Supply Chain with WIN SOURCE Solutions

-  Global Sourcing Solution
-  Obsolete Management
-  Cost Control Management
-  Shortage Management
-  Alternative Solution
-  Excess Inventory Management