



THE DATASHEET OF MOC5008M





6-Pin DIP Optoisolators Logic Output

The MOC5007, MOC5008 and MOC5009 have a gallium arsenide IRED optically coupled to a high-speed integrated detector with Schmitt trigger output. Ideal for applications requiring electrical isolation, fast response time, noise immunity and digital logic compatibility.

- Guaranteed Switching Times — t_{on} , t_{off} $4 < \mu s$
- Built-In ON/OFF Threshold Hysteresis
- High Data Rate, 1 MHz Typical (NRZ)
- Wide Supply Voltage Capability
- Microprocessor Compatible Drive
- **To order devices that are tested and marked per VDE 0884 requirements, the suffix "V" must be included at end of part number. VDE 0884 is a test option.**

Applications

- Interfacing Computer Terminals to Peripheral Equipment
- Digital Control of Power Supplies
- Line Receiver — Eliminates Noise
- Digital Control of Motors and Other Servo Machine Applications
- Logic to Logic Isolator
- Logic Level Shifter — Couples TTL to CMOS

MAXIMUM RATINGS ($T_A = 25^\circ C$ unless otherwise noted)

| Rating | Symbol | Value | Unit |
|--------|--------|-------|------|
|--------|--------|-------|------|

INPUT LED

| | | | |
|--|-------|------|----------------|
| Reverse Voltage | V_R | 6 | Volts |
| Forward Current — Continuous | I_F | 60 | mA |
| Peak | | 1.2 | Amp |
| Pulse Width = 300 μs , 2% Duty Cycle | | | |
| LED Power Dissipation @ $T_A = 25^\circ C$ | P_D | 120 | mW |
| Derate above $25^\circ C$ | | 1.41 | mW/ $^\circ C$ |

OUTPUT DETECTOR

| | | | |
|---|----------|------|----------------|
| Output Voltage Range | V_O | 0–16 | Volts |
| Supply Voltage Range | V_{CC} | 3–16 | Volts |
| Output Current | I_O | 50 | mA |
| Detector Power Dissipation @ $T_A = 25^\circ C$ | P_D | 150 | mW |
| Derate above $25^\circ C$ | | 1.76 | mW/ $^\circ C$ |

TOTAL DEVICE

| | | | |
|---|-----------|-------------|----------------|
| Total Device Power Dissipation @ $T_A = 25^\circ C$ | P_D | 250 | mW |
| Derate above $25^\circ C$ | | 2.94 | mW/ $^\circ C$ |
| Maximum Operating Temperature | T_A | –40 to +85 | $^\circ C$ |
| Storage Temperature Rang | T_{stg} | –55 to +150 | $^\circ C$ |
| Soldering Temperature (10 s) | T_L | 260 | $^\circ C$ |
| Isolation Surge Voltage ⁽¹⁾ (Peak ac Voltage, 60 Hz, 1 Second Duration) | V_{ISO} | 7500 | Vac(pk) |

1. Isolation surge voltage is an internal device dielectric breakdown rating.
For this test, Pins 1 and 2 are common, and Pins 4, 5 and 6 are common.

MOC5007
MOC5008
MOC5009

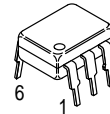

STANDARD THRU HOLE

SCHEMATIC

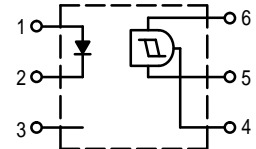

- PIN 1. ANODE
2. CATHODE
3. NC
4. OPEN COLLECTOR
OUTPUT
5. GROUND
6. V_{CC}

ELECTRICAL CHARACTERISTICS ($T_A = 25^\circ\text{C}$ unless otherwise noted)⁽¹⁾

| Characteristic | Symbol | Min | Typ ¹⁾ | Max | Unit | |
|--|--|-----------|-------------------|----------|------------------|---------------|
| INPUT LED | | | | | | |
| Reverse Leakage Current ($V_R = 3\text{ V}$, $R_L = 1\text{ M}\Omega$) | I_R | — | 0.05 | 10 | μA | |
| Forward Voltage ($I_F = 10\text{ mA}$) ($I_F = 0.3\text{ mA}$) | V_F | — 0.75 | 1.2 0.95 | 1.5 — | Volts | |
| Capacitance ($V_R = 0\text{ V}$, $f = 1\text{ MHz}$) | C | — | 18 | — | pF | |
| OUTPUT DETECTOR | | | | | | |
| Operating Voltage | V_{CC} | 3 | — | 15 | Volts | |
| Supply Current ($I_F = 0$, $V_{CC} = 5\text{ V}$) | $I_{CC(\text{off})}$ | — | 1 | 5 | mA | |
| Output Current, High ($I_F = 0$, $V_{CC} = V_O = 15\text{ V}$) | I_{OH} | — | — | 100 | μA | |
| COUPLED | | | | | | |
| Supply Current ($I_F = I_{F(\text{on})}$, $V_{CC} = 5\text{ V}$) | $I_{CC(\text{on})}$ | — | 1.6 | 5 | mA | |
| Output Voltage, Low ($R_L = 270\ \Omega$, $V_{CC} = 5\text{ V}$, $I_F = I_{F(\text{on})}$) | V_{OL} | — | 0.2 | 0.4 | Volts | |
| Threshold Current, ON ($R_L = 270\ \Omega$, $V_{CC} = 5\text{ V}$) | $I_{F(\text{on})}$ | — | 1.2 | 1.6 | mA | |
| | MOC5007 | — | — | 4 | | |
| | MOC5008 | — | — | 10 | | |
| | MOC5009 | — | — | — | | |
| Threshold Current, OFF ($R_L = 270\ \Omega$, $V_{CC} = 5\text{ V}$) | $I_{F(\text{off})}$ | 0.3 | 0.75 | — | mA | |
| | MOC5007 | 0.3 | — | — | | |
| | MOC5008, 5009 | — | — | — | | |
| Hysteresis Ratio ($R_L = 270\ \Omega$, $V_{CC} = 5\text{ V}$) | $\frac{I_{F(\text{off})}}{I_{F(\text{on})}}$ | 0.5 | 0.75 | 0.9 | | |
| Isolation Voltage ⁽²⁾ 60 Hz, AC Peak, 1 second, $T_A = 25^\circ\text{C}$ | V_{ISO} | 7500 | — | — | Vac(pk) | |
| Turn-On Time | $R_L = 270\ \Omega^{(3)}$ $V_{CC} = 5\text{ V}$, $I_F = I_{F(\text{on})}$ $T_A = 25^\circ\text{C}$ | t_{on} | — | 1.2 | 4 | μs |
| Fall Time | | t_f | — | 0.1 | — | |
| Turn-Off Time | | t_{off} | — | 1.2 | 4 | |
| Rise Time | | t_r | — | 0.1 | — | |

1. Always design to the specified minimum/maximum electrical limits (where applicable).
2. For this test, IRED Pins 1 and 2 are common and Output Gate Pins 4, 5, 6 are common.
3. R_L value effect on switching time is negligible.

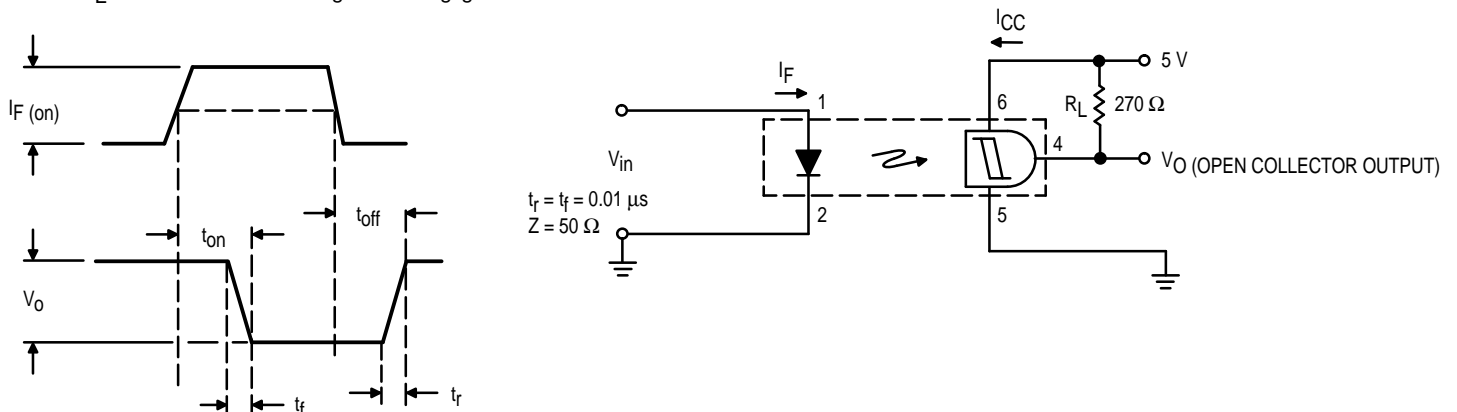

Figure 1. Switching Test Circuit

TYPICAL CHARACTERISTICS

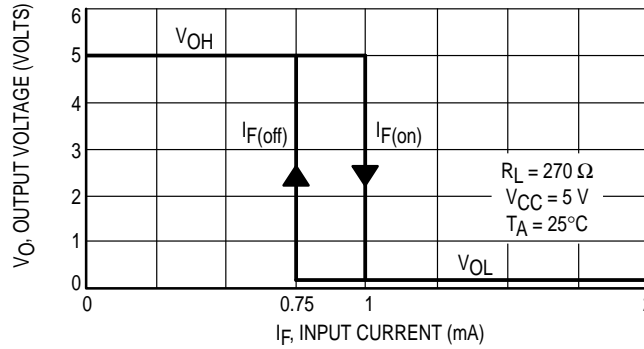

Figure 2. Transfer Characteristics for MOC5007

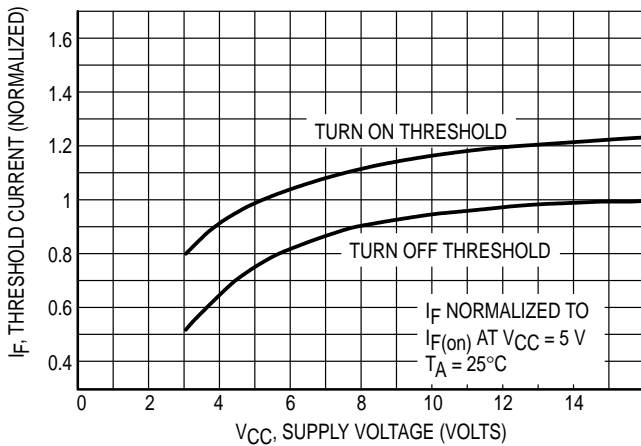

Figure 3. Threshold Current versus Supply Voltage

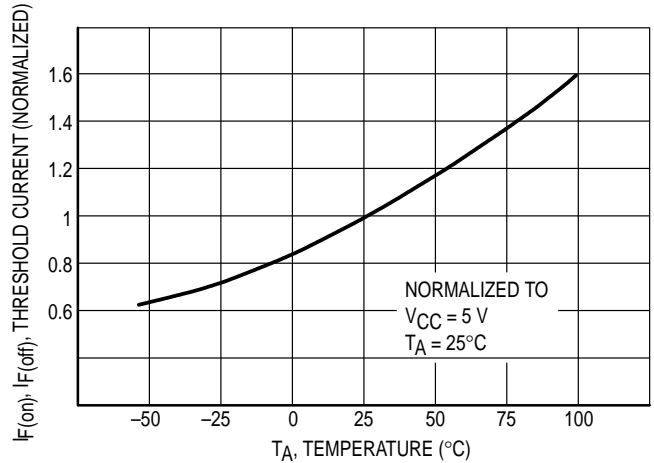

Figure 4. Threshold Current versus Temperature

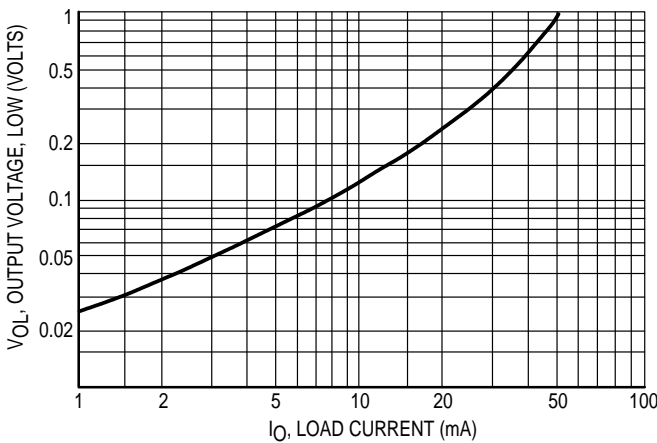

Figure 5. Output Voltage, Low versus Load Current

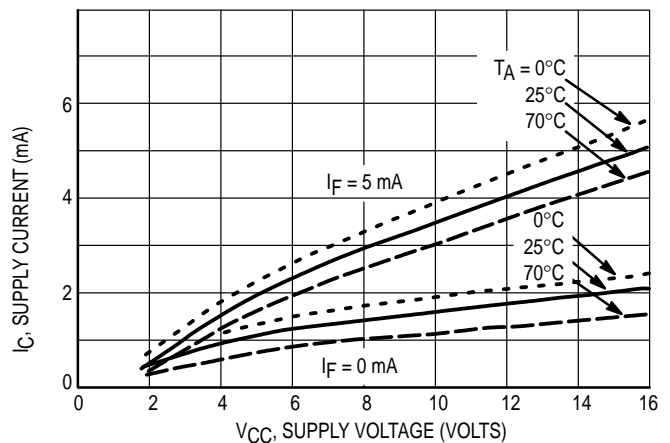
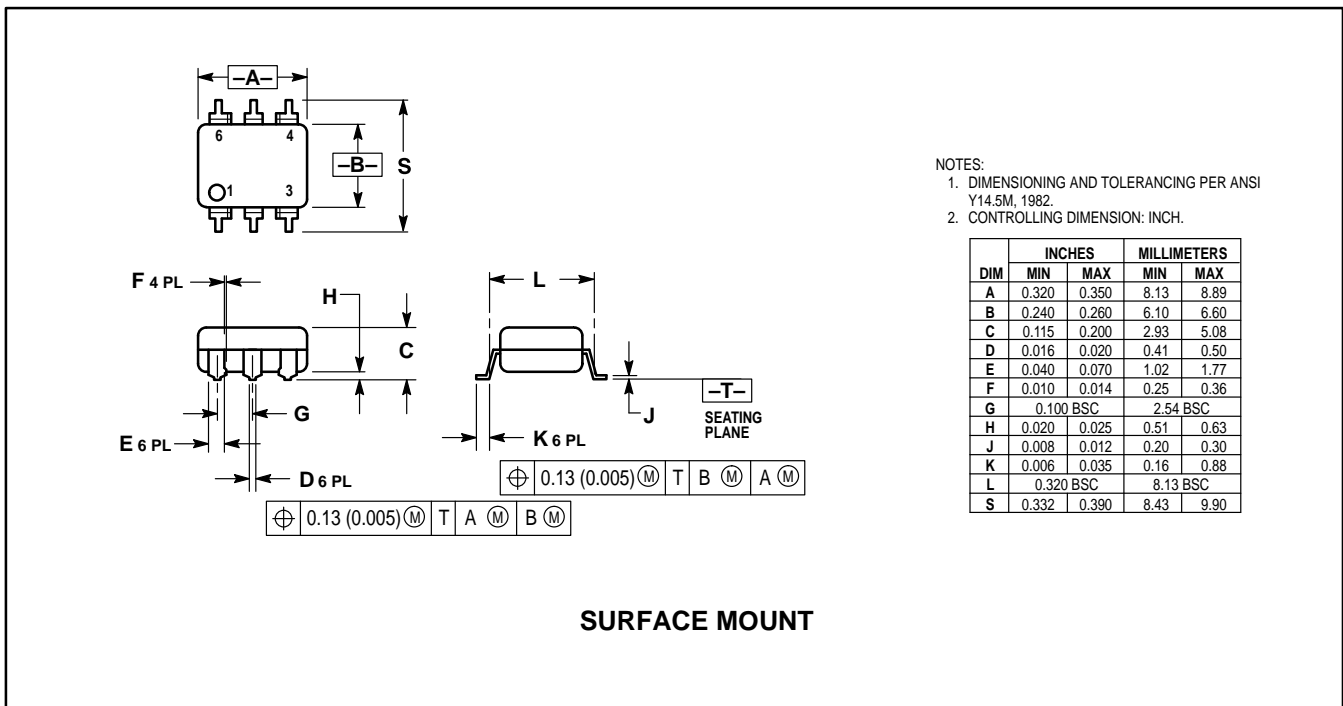
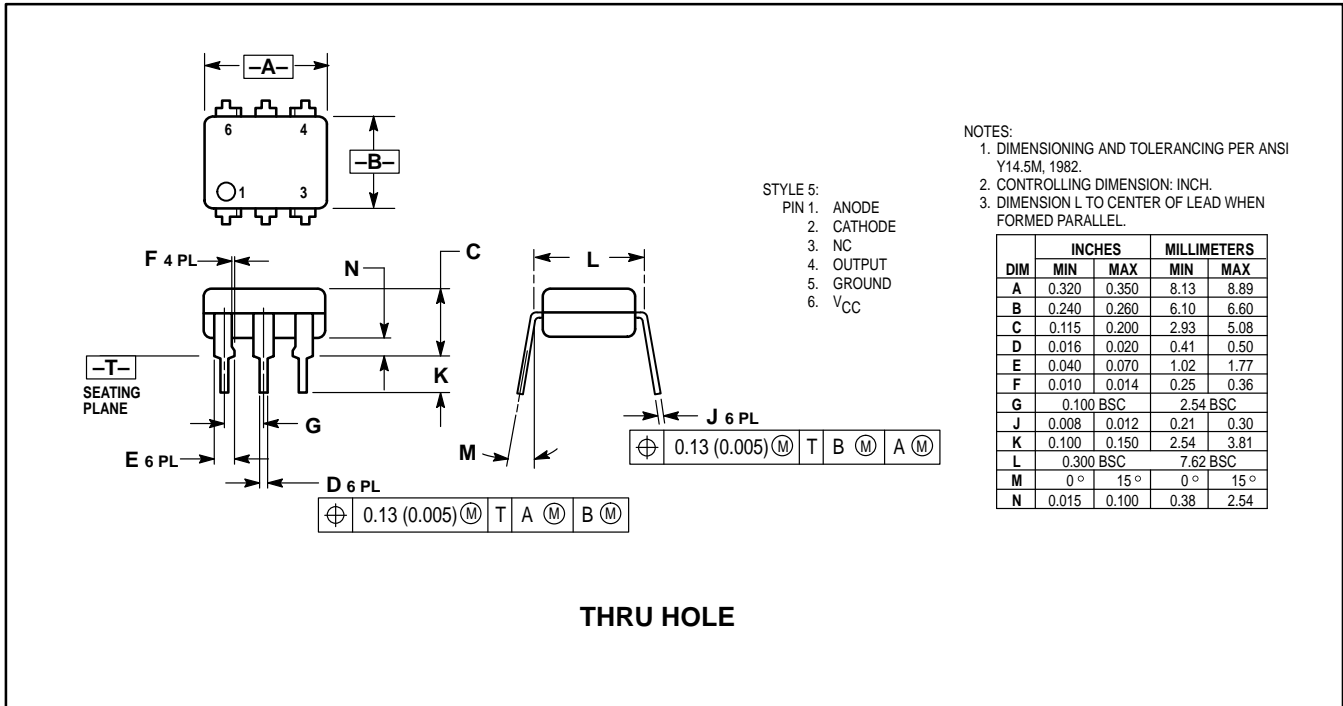
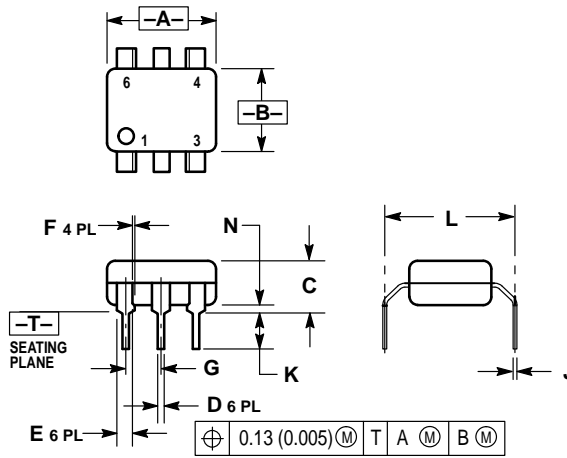

Figure 6. Supply Current versus Supply Voltage

PACKAGE DIMENSIONS





- NOTES:
 1. DIMENSIONING AND TOLERANCING PER ANSI Y14.5M, 1982.
 2. CONTROLLING DIMENSION: INCH.
 3. DIMENSION L TO CENTER OF LEAD WHEN FORMED PARALLEL.

| DIM | INCHES | | MILLIMETERS | |
|-----|-----------|-------|-------------|-------|
| | MIN | MAX | MIN | MAX |
| A | 0.320 | 0.350 | 8.13 | 8.89 |
| B | 0.240 | 0.260 | 6.10 | 6.60 |
| C | 0.115 | 0.200 | 2.93 | 5.08 |
| D | 0.016 | 0.020 | 0.41 | 0.50 |
| E | 0.040 | 0.070 | 1.02 | 1.77 |
| F | 0.010 | 0.014 | 0.25 | 0.36 |
| G | 0.100 BSC | | 2.54 BSC | |
| J | 0.008 | 0.012 | 0.21 | 0.30 |
| K | 0.100 | 0.150 | 2.54 | 3.81 |
| L | 0.400 | 0.425 | 10.16 | 10.80 |
| N | 0.015 | 0.040 | 0.38 | 1.02 |

0.4" LEAD SPACING

DISCLAIMER

FAIRCHILD SEMICONDUCTOR RESERVES THE RIGHT TO MAKE CHANGES WITHOUT FURTHER NOTICE TO ANY PRODUCTS HEREIN TO IMPROVE RELIABILITY, FUNCTION OR DESIGN. FAIRCHILD DOES NOT ASSUME ANY LIABILITY ARISING OUT OF THE APPLICATION OR USE OF ANY PRODUCT OR CIRCUIT DESCRIBED HEREIN; NEITHER DOES IT CONVEY ANY LICENSE UNDER ITS PATENT RIGHTS, NOR THE RIGHTS OF OTHERS.



LIFE SUPPORT POLICY

FAIRCHILD'S PRODUCTS ARE NOT AUTHORIZED FOR USE AS CRITICAL COMPONENTS IN LIFE SUPPORT DEVICES OR SYSTEMS WITHOUT THE EXPRESS WRITTEN APPROVAL OF THE PRESIDENT OF FAIRCHILD SEMICONDUCTOR CORPORATION. As used herein:

1. Life support devices or systems are devices or systems which, (a) are intended for surgical implant into the body, or (b) support or sustain life, and (c) whose failure to perform when properly used in accordance with instructions for use provided in the labeling, can be reasonably expected to result in a significant injury of the user.
2. A critical component in any component of a life support device or system whose failure to perform can be reasonably expected to cause the failure of the life support device or system, or to affect its safety or effectiveness.

Looking for pricing, stock, or lifecycle information?

Click below to explore more details on WIN SOURCE:

-  [View MOC5008M](#) on WIN SOURCE
-  [ON Semiconductor](#) Information

Optimize Your Supply Chain with WIN SOURCE Solutions

-  Global Sourcing Solution
-  Obsolete Management
-  Cost Control Management
-  Shortage Management
-  Alternative Solution
-  Excess Inventory Management