



THE DATASHEET OF MOC3062XSM



MOC306x



DESCRIPTION

The MOC306x Series are optically coupled isolators consisting of a Gallium Arsenide infrared emitting diode coupled with a monolithic silicon detector performing the functions of a zero crossing bilateral triac mounted in a standard 6 pin dual-in-line package.

FEATURES

- Zero Voltage Crossing
- Triac Driver Output
- High V_{DRM} minimum 600V
- High Critical Rate of Rise of Off-State Voltage dv/dt minimum 600V/ μ s
- Isolation Voltage 5000V_{RMS}
- RoHS Compliant
- UL File No. E91231 Package System "TT"
- VDE File No. 40028086

APPLICATIONS

- Solenoid / Valve Controls
- Light Controls
- AC Motor Drivers
- Temperature Controls
- AC Motor Starters
- Solid State Relays

ORDER INFORMATION

- Add Suffix "X" for VDE Approval
- Add G after PN for 10mm lead spacing
- Add SM after PN for Surface Mount
- Add SMT&R after PN for Surface Mount Tape & Reel

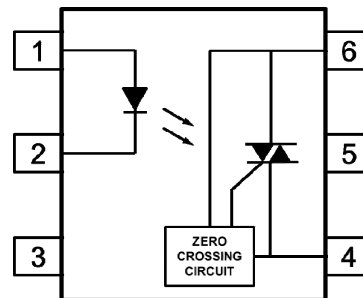

- 1 Anode
- 2 Cathode
- 3 NC
- 4 Main Terminal 1
- 5 Substrate, (Do not Connect)
- 6 Main Terminal 2

ABSOLUTE MAXIMUM RATINGS

$T_A = 25^\circ\text{C}$ unless otherwise specified.

Stresses exceeding the absolute maximum ratings can cause permanent damage to the device.

Exposure to absolute maximum ratings for long periods of time can adversely affect reliability.

Input

Forward Current	50mA
Reverse Voltage	6V
Junction Temperature	125°C
Power dissipation	120mW

Output

Off State Output Terminal Voltage	600V
On State RMS Current	100mA _{RMS}
Peak Repetitive Surge Current (Pulse Width 100 μ s, 120pps)	1.0A
Junction Temperature	125°C
Power Dissipation	150mW

Total Package

Isolation Voltage	5000V _{RMS}
Total Power Dissipation	250mW
Operating Temperature	-40 to 100°C
Storage Temperature	-55 to 150°C
Lead Soldering Temperature (10s)	260°C

ISOCOM COMPONENTS 2004 LTD

Unit 25B, Park View Road West, Park View Industrial Estate
Hartlepool, Cleveland, TS25 1PE, United Kingdom
Tel: +44 (0)1429 863 609 Fax : +44 (0)1429 863 581
e-mail: sales@isocom.co.uk
<http://www.isocom.com>

ISOCOM COMPONENTS ASIA LTD

Hong Kong Office,
Block A, 8/F, Wah Hing Industrial mansion,
36 Tai Yau Street, San Po Kong, Kowloon, Hong Kong.
Tel: +852 2995 9217 Fax : +852 8161 6292
e-mail sales@isocom.com.hk



MOC306x

ELECTRICAL CHARACTERISTICS ($T_A = 25^\circ\text{C}$ unless otherwise specified)

INPUT

Parameter	Symbol	Test Condition	Min	Typ.	Max	Unit
Forward Voltage	V_F	$I_F = 20\text{mA}$		1.2	1.4	V
Reverse Current	I_R	$V_R = 6\text{V}$		0.05	10	μA

OUTPUT

Parameter	Symbol	Test Condition	Min	Typ.	Max	Unit
Peak Off-state Current Either Direction	I_{DRM}	$V_{\text{DRM}} = 600\text{V}$ $I_F = 0\text{mA}$ Note 1			500	nA
Peak Blocking Voltage Either Direction	V_{DRM}	$I_{\text{DRM}} = 500\text{nA}$	600			V
On-state Voltage Either Direction	V_{TM}	$I_{\text{TM}} = 100\text{mA (peak)}$			3.0	V
Critical Rate of Rise of Off-state Voltage (Static dv/dt)	dv/dt	$I_F = 0\text{mA}$, $V_{\text{in}} = 240\text{V}_{\text{RMS}}$	1000			V/ μs

COUPLED

Parameter	Symbol	Test Condition	Min	Typ.	Max	Unit
Input Trigger Current Either Direction	I_{FT}	$V_{\text{TM}} = 3\text{V}$ Note 2 MOC3060 MOC3061 MOC3062 MOC3063			30 15 10 5	mA
Holding Current Either Direction	I_{H}			400		μA



MOC306x

ELECTRICAL CHARACTERISTICS ($T_A = 25^\circ\text{C}$ unless otherwise specified)

ZERO CROSSING CHARACTERISTICS

Parameter	Symbol	Test Condition	Min	Typ.	Max	Unit
Inhibit Voltage	V_{INH}	$I_F = \text{Rated } I_{FT}$, MT1-MT2 Voltage above which device will not trigger		5	20	V
Leakage Current at Inhibit State	I_{DRM2}	$I_F = \text{Rated } I_{FT}$, $V_{DRM} = 600\text{V}$, Off-state			500	μA

ISOLATION

Parameter	Symbol	Test Condition	Min	Typ.	Max	Unit
Isolation Voltage Input-Output	V_{ISO}	RH = 40 to 60%, t = 1 min Note 3	5000			V_{RMS}

Note 1 : Test Voltage must be applied within dv/dt rating.

Note 2 : Guaranteed to trigger at an I_F value less than or equal to max I_{FT} ,
recommended I_F lies between Rated I_{FT} to Absolute Max I_F .

Note 3 : Measured with input leads shorted together and output leads shorted together.

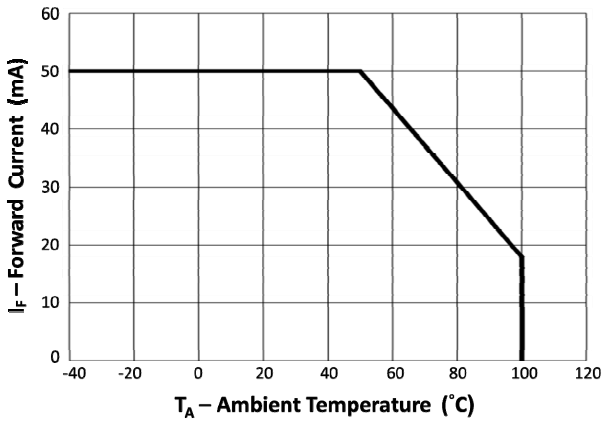

Fig 1 Forward Current vs Ambient Temperature

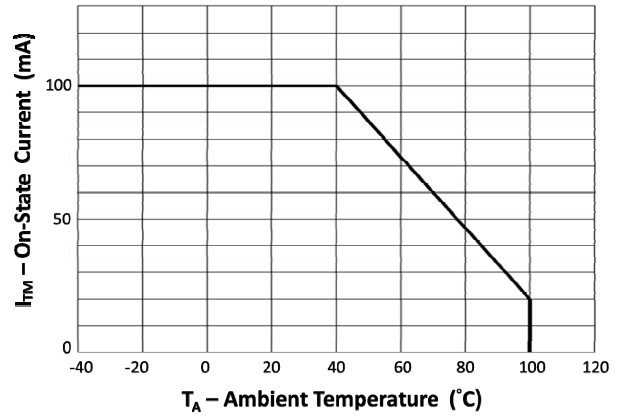

Fig 2 On-State Current vs Ambient Temperature

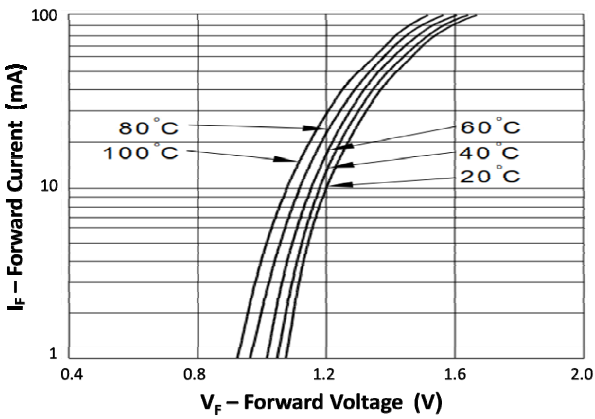

Fig 3 Forward Current vs Forward Voltage

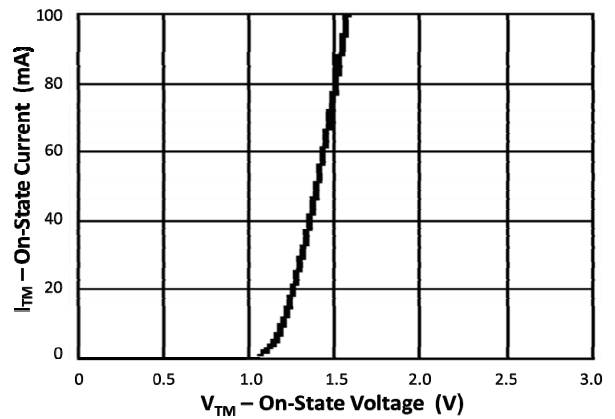

Fig 4 On-state Current vs On-State Voltage

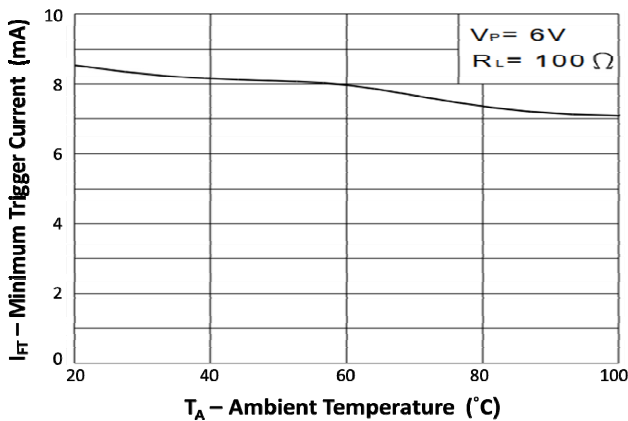

Fig 5 Minimum Trigger Current vs Ambient Temperature

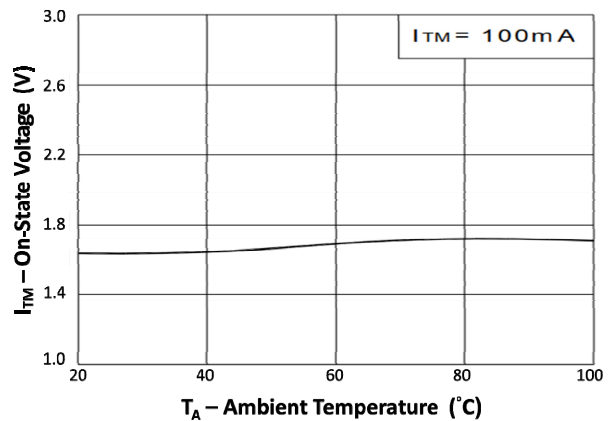

Fig 6 On-State Voltage vs Ambient Temperature

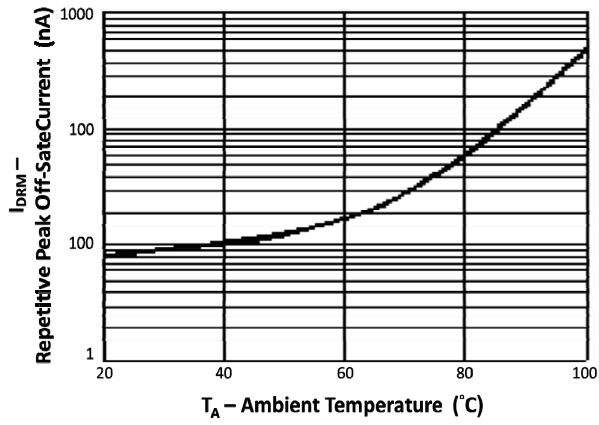

Fig 7 Repetitive Peak Off-State Current vs Ambient Temperature

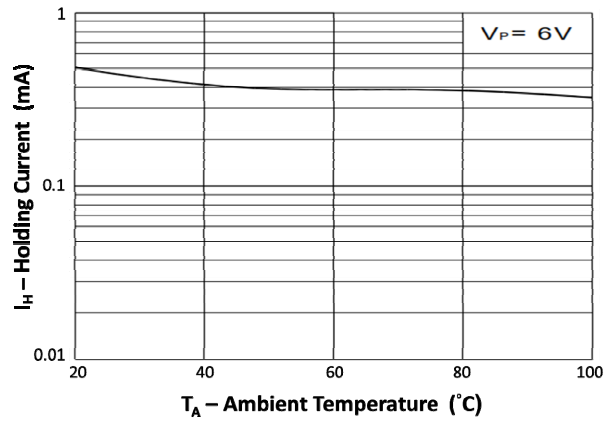

Fig 8 Holding Current vs Ambient Temperature

MOC306x

ORDER INFORMATION

MOC306x (UL Approval)			
After PN	PN	Description	Packing quantity
None	MOC3060, MOC3061, MOC3062, MOC3063	Standard DIP6	65 pcs per tube
G	MOC3060G, MOC3061G, MOC3062G, MOC3063G	10mm Lead Spacing	65 pcs per tube
SM	MOC3060SM, MOC3061SM, MOC3062SM, MOC3063SM	Surface Mount	65 pcs per tube
SMT&R	MOC3060SMT&R, MOC3061SMT&R, MOC3062SMT&R, MOC3063SMT&R	Surface Mount Tape & Reel	1000 pcs per reel

MOC306x (UL and VDE Approvals)			
After PN	PN	Description	Packing quantity
None	MOC3060X, MOC3061X, MOC3062X, MOC3063X	Standard DIP6	65 pcs per tube
G	MOC3060XG, MOC3061XG, MOC3062XG, MOC3063XG	10mm Lead Spacing	65 pcs per tube
SM	MOC3060XSM, MOC3061XSM, MOC3062XSM, MOC3063XSM	Surface Mount	65 pcs per tube
SMT&R	MOC3060XSMT&R, MOC3061XSMT&R, MOC3062XSMT&R, MOC3063XSMT&R	Surface Mount Tape & Reel	1000 pcs per reel

DEVICE MARKING

Example : MOC3063X

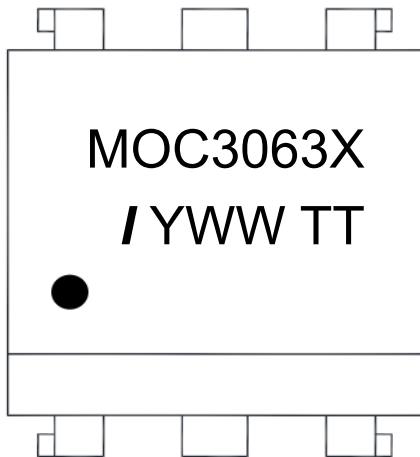

MOC3063X Denotes Device Part Number

/ denotes Isocom

Y denotes 2 digit Year code

WW denotes 2 digit Week code

TT UL Package System Code

MOC306x

PACKAGE DIMENSIONS in mm (inch)

DIP

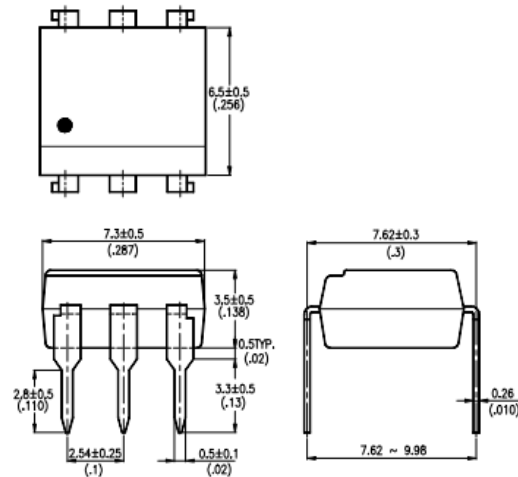

G Form

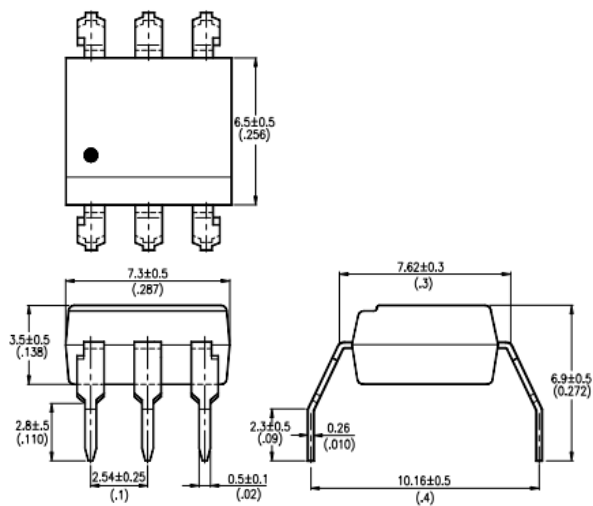

SMD

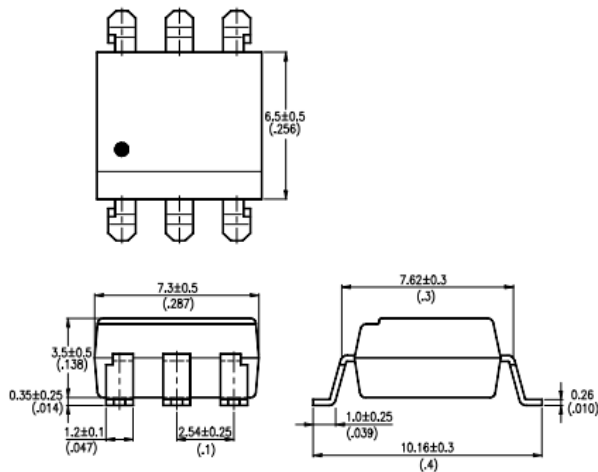

MOC306x

TAPE AND REEL PACKAGING

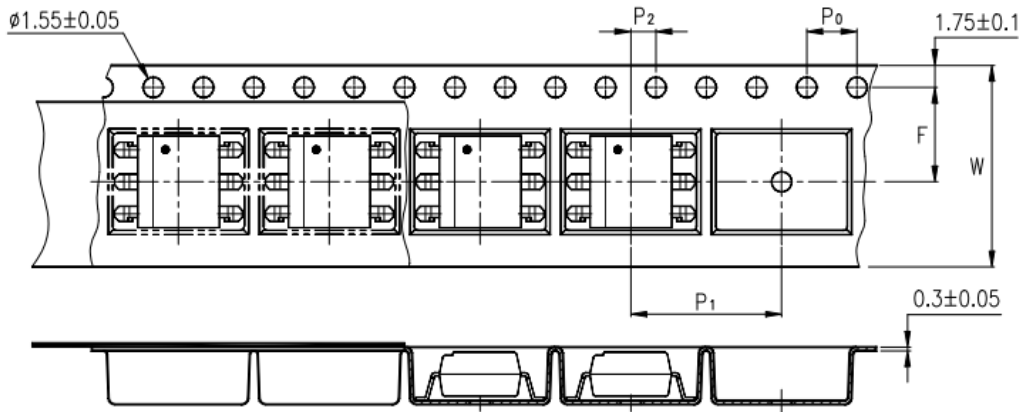

Description	Symbol	Dimension mm (inch)
Tape Width	W	16 ± 0.3 (0.63)
Pitch of Sprocket Holes	P ₀	4 ± 0.1 (0.15)
Distance of Compartment to Sprocket Holes	F	7.5 ± 0.1 (0.295)
	P ₂	2 ± 0.1 (0.079)
Distance of Compartment to Compartment	P ₁	12 ± 0.1 (0.47)

RECOMMENDED PAD LAYOUT for SMD (mm)

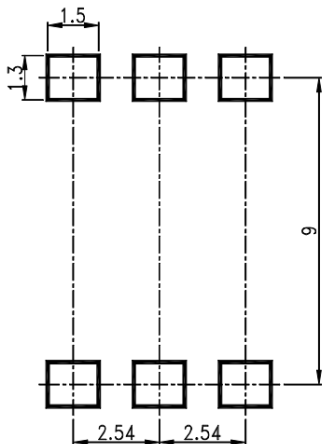

IR REFLOW SOLDERING TEMPERATURE PROFILE
One Time Reflow Soldering is Recommended.
Do not immerse device body in solder paste.

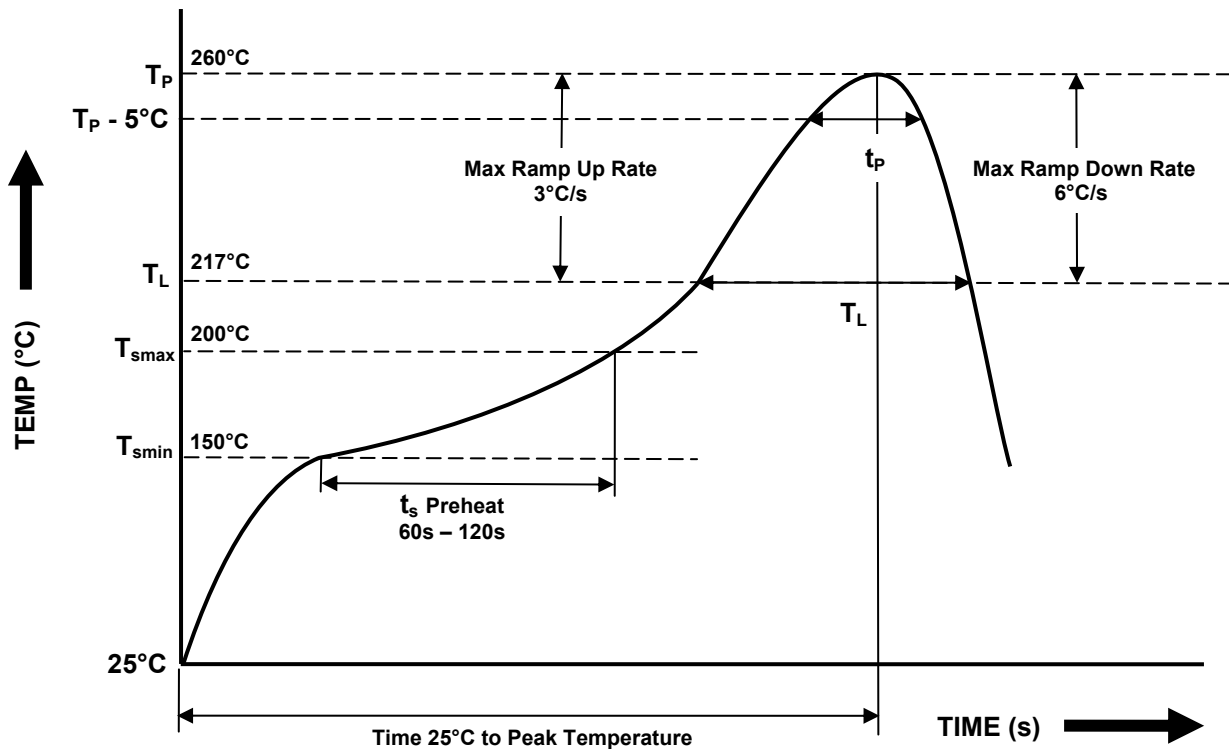

Profile Details	Conditions
Preheat - Min Temperature (T _{SMIN}) - Max Temperature (T _{SMAX}) - Time T _{SMIN} to T _{SMAX} (t _s)	150°C 200°C 60s - 120s
Soldering Zone - Peak Temperature (T _P) - Time at Peak Temperature - Liquidous Temperature (T _L) - Time within 5°C of Actual Peak Temperature (T _P - 5°C) - Time maintained above T _L (t _L) - Ramp Up Rate (T _L to T _P) - Ramp Down Rate (T _P to T _L)	260°C 10s max 217°C 30s max 60s - 100s 3°C/s max 6°C/s max
Average Ramp Up Rate (T _{smax} to T _P)	3°C/s max
Time 25°C to Peak Temperature	8 minutes max



DISCLAIMER

Isocom Components is continually working to improve the quality and reliability of its products. Nevertheless, semiconductor devices in general can malfunction or fail due to their inherent electrical sensitivity and vulnerability to physical stress. It is the responsibility of the buyer, when utilizing Isocom Components products, to comply with the standards of safety in making a safe design for the entire system, and to avoid situations in which a malfunction or failure of such Isocom Components products could cause loss of human life, bodily injury or damage to property.

In developing your designs, please ensure that Isocom Components products are used within specified operating ranges as set forth in the most recent Isocom Components products specifications.

The Isocom Components products listed in this document are intended for usage in general electronics applications (computer, personal equipment, office equipment, measuring equipment, industrial robotics, domestic appliances, etc.). These Isocom Components products are neither intended nor warranted for usage in equipment that requires extraordinarily high quality and/or reliability or a malfunction or failure of which may cause loss of human life or bodily injury ("Unintended Usage"). Unintended Usage include atomic energy control instruments, airplane or spaceship instruments, transportation Instruments, traffic signal instruments, combustion control instruments, medical Instruments, all types of safety devices, etc... Unintended Usage of Isocom Components products listed in this document shall be made at the customer's own risk.

Gallium arsenide (GaAs) is a substance used in the products described in this document. GaAs dust and fumes are toxic. Do not break, cut or pulverize the product, or use chemicals to dissolve them. When disposing of the products, follow the appropriate regulations. Do not dispose of the products with other industrial waste or with domestic garbage.

The products described in this document are subject to the foreign exchange and foreign trade laws.

The information contained herein is presented only as a guide for the applications of our products. No responsibility is assumed by Isocom Components for any infringements of intellectual property or other rights of the third parties which may result from its use. No license is granted by implication or otherwise under any intellectual property or other rights of Isocom Components or others.

The information contained herein is subject to change without notice.

Looking for pricing, stock, or lifecycle information?

Click below to explore more details on WIN SOURCE:

- ⊖ [View MOC3062XSM on WIN SOURCE](#)
- ⊖ [Isocom Components 2004 LTD Information](#)

Optimize Your Supply Chain with WIN SOURCE Solutions

- ✓ Global Sourcing Solution
- ✓ Obsolete Management
- ✓ Cost Control Management
- ✓ Shortage Management
- ✓ Alternative Solution
- ✓ Excess Inventory Management