



**THE DATASHEET OF
MLX91208LDC-CAV-000-RE**



1. Features and Benefits

- IMC-Hall® Technology
- Very high sensitivity due to Integrated Magnetic Concentrator (IMC-Hall®)
- Programmable high speed current sensor IC
- Wideband: DC to 250kHz
- Short response time 3µs
- Programmable linear transfer characteristic
- Selectable Analog ratiometric output
- SOIC8 package RoHS compliant
- Lead free component, suitable for lead free soldering profile 260°C (target), MSL3
- AEC-Q100 Automotive Qualified

2. Application Examples

- Inverter HEV and EV
- BLDC motor current monitoring
- Smart fuse (over-current detection)
- AC/DC Converters
- DC/AC Converter (inverter)
- DC/DC switched mode power supply

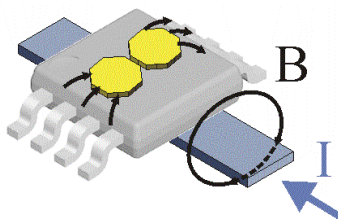

Figure 1: Typical application of MLX91208

3. Description

The MLX91208 is a monolithic sensor IC featuring the IMC-Hall® technology. Conventional planar Hall technology is only sensitive to the flux density applied orthogonally to the IC surface. The IMC-Hall® current sensor is sensitive to the flux density applied parallel to the IC surface. This is obtained through an Integrated Magneto-Concentrator (IMC-Hall®) which is deposited on the CMOS die (as an additional back-end step). The IMC-Hall® technology is automotive qualified.

The product is a single chip Hall sensor which provides an output signal proportional to the flux density applied horizontally and is therefore suitable for current measurement. It is ideally suited as an open loop current sensor for PCB or bus bar mounting. It features small size application design and a simple construction for various current ranges from few Amperes up to 1000 Amperes.

The transfer characteristic of the MLX91208 is programmable in terms of offset, gain or temperature compensation. The linear analog output is designed for applications where a very fast response is required, such as inverter applications.

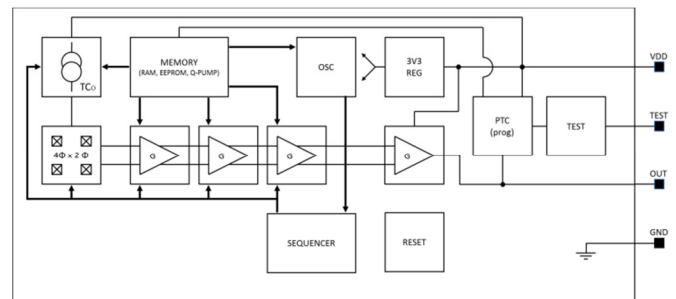

Figure 2: Block diagram

4. Ordering Information

Product	Temperature	Package	Option Code	Packing Form	Sensitivity Range (typ.)
ML91208	L (-40°C to 150°C)	DC	CAL - 000	TU/RE	100-700mV/mT (250mV/mT)
ML91208	L (-40°C to 150°C)	DC	CAH - 000	TU/RE	50-350mV/mT (100mV/mT)
ML91208	L (-40°C to 150°C)	DC	CAV - 000	TU/RE	30-200mV/mT (40mV/mT)
ML91208	L (-40°C to 150°C)	DC	CAV - 001	TU/RE	30-200mV/mT (60mV/mT)

Table 1: Ordering Information

Legend:

Temperature Code:	L	- from -40°C to 150°C
Package Code:	DC	- for SOIC-8 package
Option Code:	xxL xxH xxV	- Low field version - High field version - Very high field version
Packing Form Code:	RE TU	- for Reel - for Tube
Ordering Example:	"MLX91208LDC-CAH-000-RE"	

Table 2: Legend

5. Glossary of Terms

Terms	Definition
Tesla	Units for the magnetic flux density, 1 mT = 10 Gauss
TC	Temperature Coefficient in ppm/deg C
NC	Not Connected
ADC	Analog to Digital Converter
DAC	Digital to Analog Converter
LSB	Least Significant Bit
MSB	Most Significant Bit
DNL	Differential Non Linearity
INL	Integral Non Linearity
IMC	Integrated Magneto Concentrator (IMC-HALL®)
PTC	Programming Through Connector

Table 3: Glossary of terms

Contents

1. Features and Benefits.....	1
2. Application Examples.....	1
3. Description.....	1
4. Ordering Information.....	2
5. Glossary of Terms.....	2
6. Absolute Maximum Ratings.....	5
7. Pin Definitions and Descriptions.....	5
8. General Electrical Specifications.....	6
9. Magnetic specification.....	7
9.1. Low Field Version 10mT (option code xxL).....	7
9.2. High Field Version 25mT (option code xxH).....	7
9.3. Very High Field Version 60mT (option code xxV).....	8
10. Analog output specification.....	8
10.1. Timing specification.....	8
10.2. Accuracy specification.....	9
10.3. Remarks to the achievable accuracy.....	10
11. Programmable items.....	10
11.1. Parameter table.....	10
11.2. Sensitivity programming (RG, FG).....	10
11.3. Offset / output quiescent voltage programming (VOQ).....	10
11.4. Output ratiometry (ENRATIO).....	11
11.5. Sensitivity temperature drift programming (TC1ST, TC2ND_COLD, TC2ND_HOT).....	11
11.6. Offset temperature drift programming (OFFDR2C, OFFDR2H).....	11
11.7. Noise filter (NOISEFILT).....	11
11.8. Identification code (ID).....	11
12. Self-diagnostic.....	12
13. Application information.....	12
14. Recommended Application Diagrams.....	13
14.1. Resistor and capacitor values.....	13
14.2. Pull-down resistor for diagnostic low.....	13
15. Typical performance.....	14
16. Standard information regarding manufacturability of Melexis products with different soldering processes.....	15
17. ESD Precautions.....	15

18. Package information.....	16
18.1. SOIC-8 Package Dimensions	16
18.2. SOIC-8 Pinout and Marking	16
18.3. SOIC-8 Hall plate position.....	17
18.4. SOIC-8 IMC Position and magnetic sensitive direction.....	17
19. Contact.....	18
20. Disclaimer.....	18

6. Absolute Maximum Ratings

Parameters	Symbol	Value	Units
Positive Supply Voltage (overvoltage)	Vdd	+10	V
Reverse Supply Voltage Protection		-0.3	V
Positive Output Voltage		+10	V
Output Current	Iout	±70	mA
Reverse Output Voltage		-0.3	V
Reverse Output Current		-50	mA
Package Thermal Resistance (junction-to-ambient) θ_{ja} is defined according JEDEC 1s0p board	θ_{ja}	174	°C/W
Operating Ambient Temperature Range	TA	-40 to 150	°C
Storage Temperature Range	TS	-55 to 165	°C
Magnetic Flux Density		±3	T
Maximum Junction Temperature	Tj,max	-55 to 155	°C
ESD (HBM)		2	kV

Table 4: Absolute maximum ratings

Exceeding the absolute maximum ratings may cause permanent damage. Exposure to absolute maximum rated conditions for extended periods may affect device reliability.

7. Pin Definitions and Descriptions

Pin №	Name	Type	Function
5	VDD	Supply	Supply Voltage
3	GND	Ground	Supply Voltage
1	VDEC	Digital	Digital supply voltage
4	TEST/MUST	Digital	Test and Factory calibration
6	OUT	Analog	Current sensor output
2,7,8	NC	-	Not connected / unused

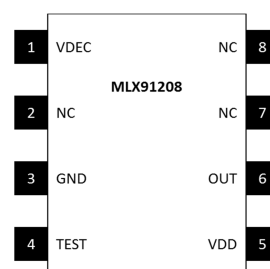

Table 5: PIN definitions and descriptions

It is recommended to connect the unused pins to the Ground for optimal EMC performance.

8. General Electrical Specifications

Operating Parameters: TA = -40 to 125deg.C, Vdd = 4.5V to 5.5V, Iout = -2mA to +2 mA, recommended application diagram in section 14, unless otherwise specified.

Parameter	Symbol	Test Conditions	Min	Typ.	Max	Units
Nominal Supply Voltage	Vdd		4.5	5	5.5	V
Supply Current	Idd	W/o output load in application mode TA = -40 to 150°C	9	12	14	mA
DC load Current	Iout	Rout in range [6kΩ, 100kΩ]	-2		2	mA
Maximum Output Current (driving capability)	I _{max}	Inside this range, output voltage reaches 3%VDD and 97%VDD	-2		2	mA
Output Resistance		Vout = 50% Vdd, RL = 6kΩ		1	5	Ω
Output Capacitive Load	C _{load}	Output amplifier is optimized for the capacitive load range.	1		10	nF
Output resistive load	R _{load}	Output resistive load for high linearity	6			kΩ
Output Short Circuit Current	I _{short}	Output shorted permanent to Vdd.		Not destroyed		
		Output shorted permanent to GND.		Not destroyed		
Leakage current	I _{leak}	High impedance mode ⁽¹⁾ T=150°C			20	uA
Linear Output Voltage Range <i>Vout in [10%Vdd, 90%Vdd]</i>	V _{out_pd}	pull down ≥ 10 kΩ	10		90	%Vdd
High-impedance levels ⁽¹⁾	mode V _{out_HiZ_pd}	pull-down RL ≤ 25 kΩ, T≤125°C			5	%Vdd
Under-voltage detection ⁽²⁾	V _{dd_uvd}	Low to high voltage	3	3.3	4	V
	V _{dd_uvh}	Hysteresis	0.20	0.3	0.45	V

¹ Refer to chapter Self-diagnostic, table 12

Over-voltage detection ⁽²⁾	V_{dd_ovd}	Low to High voltage	6.5	7.6	V
	V_{dd_ovh}	Hysteresis	0.05	0.7	V
Ratiometry enable detection ⁽²⁾	V_{ratio_d}	Low to High Voltage	4	4.50	V
	V_{ratio_h}	Hysteresis	0.01	0.5	V

Table 6: General electrical parameter

(2) According to the figure below:

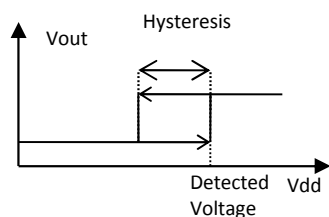

9. Magnetic specification

9.1. Low Field Version 10mT (option code xxL)

Operating Parameters TA = -40 to 125deg.C, Vdd = 4.5 V to 5.5 V, unless otherwise specified.

Parameter	Symbol	Test Conditions	Min	Typ	Max	Units
Nominal Field Range	Bnom		-7.5		+7.5	mT
Operational Field Range ⁽³⁾	Bop		-10		+10	mT
Linearity Error	NL	B in range Bop Vout in [10%VDD, 90%VDD]	-0.7		+0.7	%FS
Hysteresis, remanent Field	Br	B = Bop	-10		+10	uT
Programmable Sensitivity	S		100	250	700	mV/mT
Sensitivity programming Resolution	Sres			0.1		%

Table 7: Magnetic specification for 10mT version (low-field version)

9.2. High Field Version 25mT (option code xxH)

Operating Parameters TA = -40 to 125deg.C, Vdd = 4.5 V to 5.5 V, unless otherwise specified.

Parameter	Symbol	Test Conditions	Min	Typ	Max	Units
Nominal Field Range	Bnom		-20		+20	mT
Operational Field Range ⁽³⁾	Bop		-25		+25	mT

² See graph below the table

³ Outside Bop, the IMC progressively enters saturation, yielding to an increase of the linearity error.

Linearity Error	NL	B in range Bop Vout in [10%VDD, 90%VDD]	-0.7	+0.7	%FS	
Hysteresis, remanent Field	Br	B = Bop	-25	+25	uT	
Programmable Sensitivity	S		50	100	350	mV/mT
Sensitivity programming Resolution	Sres			0.1	%	

Table 8: Magnetic specification 25mT version (high-field version)

9.3. Very High Field Version 60mT (option code xxV)

Operating Parameters TA = -40 to 125deg.C, Vdd = 4.5 V to 5.5 V, unless otherwise specified.

Parameter	Symbol	Test Conditions	Min	Typ	Max	Units
Nominal Field Range	Bnom		-50		+50	mT
Operational Field Range ⁽³⁾	Bop		-60		+60	mT
Linearity Error	NL	B in range Bop Vout in [10%VDD, 90%VDD]	-0.7		+0.7	%FS
Hysteresis, remanent Field	Br	B = Bop	-60		+60	uT
Programmable Sensitivity	S	CAV-000	30	40	200	mV/mT
		CAV-001	30	60	200	mV/mT
Sensitivity programming Resolution	Sres			0.1	%	

Table 9: Magnetic specification 60mT version (Very high-field version)

Note: The noise filter is disabled by default for all MLX91208 versions.

10. Analog output specification

10.1. Timing specification

Operating Parameters TA = -40 to 125deg.C, Vdd = 4.5 V to 5.5 V (unless otherwise specified)

Parameter	Symbol	Test Conditions	Min	Typ	Max	Units
Refresh rate	Trr		0.8	1	2	us
Step Response Time	Tresp	Delay between the input signal reaching 90% and the output signal reaching 90%, (2V step at the output, input rise time = 1µs)				
		-Noise filter OFF		2	3	µs
		-Noise filter ON		5	6	µs
Bandwidth	BW	-Noise filter OFF	200	250	300	kHz
		-Noise filter ON	120	150	180	kHz

Power on Delay

Vout =100% of FS

Pull-down resistor
 $\leq 100k\Omega$

TPOD

During the Power-on delay,
the output will remain within
the 10% fault band at all
time.

1 ms

Ratiometry Cut-off Frequency	Fratio	250	Hz
------------------------------	--------	-----	----

Table 10: Timing specification high speed analog output

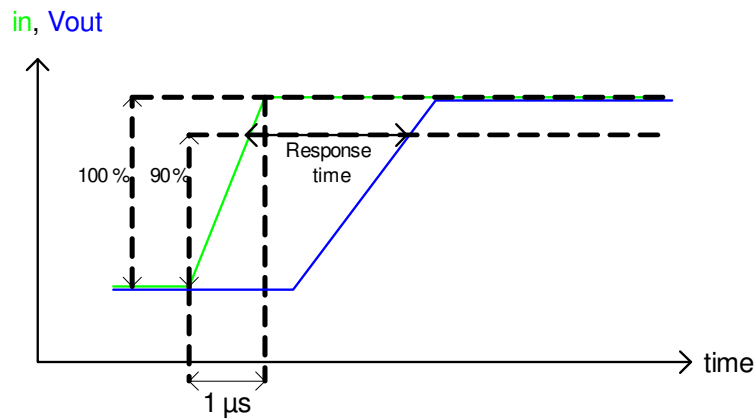

Figure 3: Response time definition

10.2. Accuracy specification

Operating Parameters $T_A = -40$ to 125°C , $V_{dd} = 4.5$ V to 5.5 V (unless otherwise specified)

Parameter	Symbol	Test Conditions	Min	Typ	Max	Units
Thermal Offset Drift	$\Delta^T V_{oq}$	Offset drift referred to 25°C $S=40\text{mV/mT}$ (xxV version) $S=100\text{mV/mT}$ (xxH version) $S=250\text{mV/mT}$ (xxL version) $V_{dd}=5\text{V}$, $TC=0\pm 150$ ppm/ $^{\circ}\text{C}$ $V_{oq}=50\pm 0.2\%$ V_{dd}	-10		+10	mV
Thermal Sensitivity Drift	TC		-1.5	0	+1.5	% of S
RMS Output noise	N_{rms}	$S=40\text{mV/mT}$ (xxV version) $S=100\text{mV/mT}$ (xxH version) $S=250\text{mV/mT}$ (xxL version) -Noise filter OFF -Noise filter ON			10 6	mVrms mVrms
Ratiometry Error Offset	ΔV_{oq}	$V_{oq} = 50\%V_{dd}$ $\Delta V_{dd} = 10\%V_{dd}$	-0.4		+0.4	% of V_{oq}
Ratiometry Error Sensitivity	ΔS	$\Delta V_{dd} = 10\%V_{dd}$	-0.4		+0.4	% of S

Table 11: Accuracy-Specific Parameters

10.3. Remarks to the achievable accuracy

The achievable target accuracy is dependent on user's end-of-line calibration. The resolution for the offset and offset drift calibration is better than 0.1%Vdd. Trimming capability is higher than the measurement accuracy. End-user calibration can increase the accuracy of the system.

11. Programmable items

11.1. Parameter table

Parameter	Bits	Factory Setting	Comment
VOQ[11:0]	12	trimmed	Quiescent output level (0 Gauss) adjustment
RG[2:0]	3	trimmed	Rough gain adjustment
FG[9:0]	10	trimmed	Fine gain adjustment
ENRATIO	1	1	Ratiometry enablement
TC1[7:0]	8	trimmed	Adjustment of the first order temperature compensation of the magnetic sensitivity
TC2HOT[4:0]	5	trimmed	Adjustment of the extra temperature compensation of the magnetic sensitivity at high temperature
TC2COLD[4:0]	5	trimmed	Adjustment of the extra temperature compensation of the magnetic sensitivity at low temperature
OFFDR2C[5:0]	6	trimmed	Adjustment of the offset drift at low temperature after the VGA
OFFDR2H[5:0]	6	trimmed	Adjustment of the offset drift at high temperature after the VGA
NOISEFILT	1	0	Noise filter enablement
ID[47:0]	48	Programmed	Melexis traceability ID

Table 12: Customer programmable items

11.2. Sensitivity programming (RG, FG)

The sensitivity can be programmed from 50 to 350mV/mT (high field version) or 100 to 700mV/mT (low field version), with the ROUGHGAIN (3 bits) and FINEGAIN (10 bits) parameters.

11.3. Offset / output quiescent voltage programming (VOQ)

The offset is programmable with 12 bits in 1.5 mV steps over the full output range. This corresponds to a calibration resolution of 0.03 %VDD.

The typical step size would be $5V/4096 = 1.22$ mV, but the actual step size can differ from the nominal value because of internal gain tolerance. A maximum step size of 1.5 mV is guaranteed.

Note: for optimal performance over temperature, the VOQ should be programmed in the range from 2 to 3V.

11.4. Output ratiometry (ENRATIO)

The ratiometry of the output versus the supply can be disabled by setting this bit to 0.

Note: for optimal performance over temperature, the ratiometry setting should not be changed on customer side. By default, this setting is enabled during final test calibration.

11.5. Sensitivity temperature drift programming (TC1ST, TC2ND_COLD, TC2ND_HOT)

First order sensitivity temperature drift can be trimmed with TC1. The programming resolution is 40ppm/K.

Second order sensitivity temperature drift can be trimmed with TC2COLD and TC2HOT. The programming resolution is 2ppm/K² for TC2COLD and 0.6ppm/K² for TC2HOT. The second order can also be seen as third order correction since cold and hot sides are independently adjusted.

Note: for optimal performance over temperature, the first order sensitivity drift compensation (TC1ST) should not exceed ±250ppm/K.

11.6. Offset temperature drift programming (OFFDR2C, OFFDR2H)

Offset temperature drift caused by the output amplifier can be compensated with these two parameters. This first order correction is done independently for temperatures over and below 25°C.

Note: Two additional parameters (OFFDR1C, OFFDR1H) are calibrated by Melexis to compensate for the offset temperature drift caused by the Hall element (before the variable gain amplifier). These parameters should not be adjusted on customer-side.

11.7. Noise filter (NOISEFILT)

Setting this bit to 1 enables the noise filter, reducing noise and increasing response time.

11.8. Identification code (ID)

48 bits programmed identification code.

12. Self-diagnostic

The MLX91208 provides self-diagnostic features to detect internal memory errors and over- / under-voltage. Those features increase the robustness of the IC functionality, as they prevent the IC from providing erroneous output signal in case of internal or external failure modes.

Error	Action	Effect on Outputs	Remarks
Calibration Data CRC Error (at power up and in normal working mode)	Fault mode	High Impedance mode	Pull down resistive load, Diagnostic Low
Power On delay		High Impedance mode	1ms max in high impedance followed by settling
Undervoltage Mode	IC is reset	High Impedance mode	300mV Hysteresis (typical)
Overvoltage detection	IC is reset	High Impedance mode	500mV Hysteresis (typical)

Table 13: Self diagnostic

13. Application information

Please refer to our current sensor reference design guide for more application information:

<https://www.melexis.com/en/documents/documentation/application-notes/application-note-current-sensor-design-guide>

14. Recommended Application Diagrams

14.1. Resistor and capacitor values

Part	Description	Value	Unit
C1	Supply capacitor, EMI, ESD	100	nF
C2	Decoupling, EMI, ESD	2-10 ⁽⁴⁾	nF
C3	Decoupling, EMI, ESD	47	nF
R1	Pull down resistor	6-100	kΩ

Table 14: Resistor and capacitor values

14.2. Pull-down resistor for diagnostic low

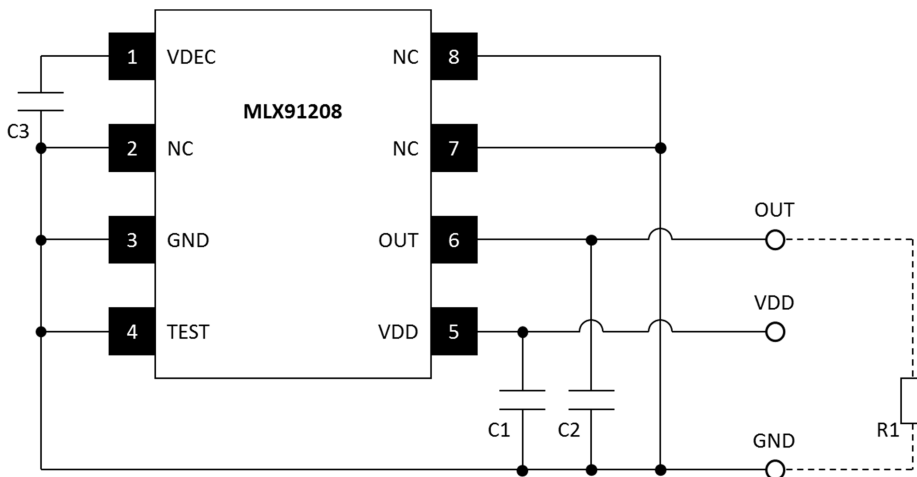

Figure 7: Diagnostic low/ Pull-down resistors

⁴ 10nF is recommended for better EMC and ESD performance

15. Typical performance

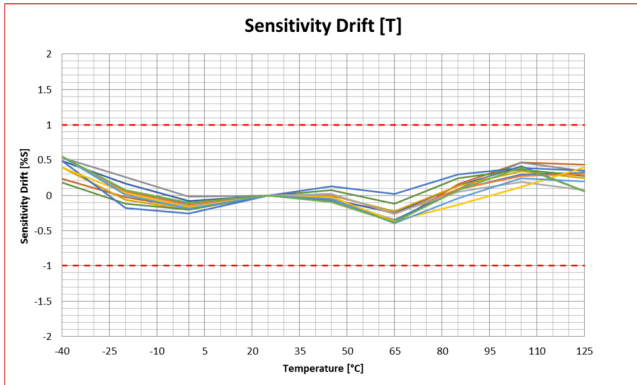

Figure 9: Thermal sensitivity drift.

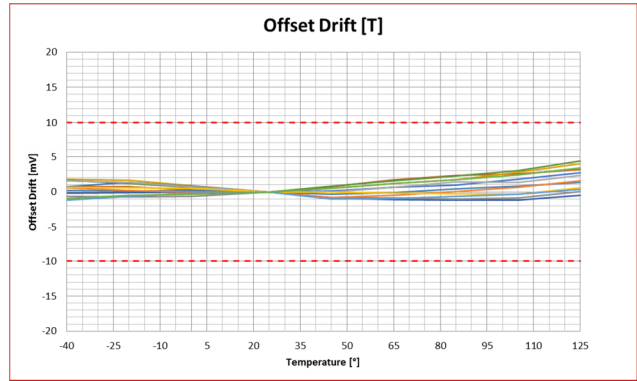

Figure 10: Thermal offset drift.

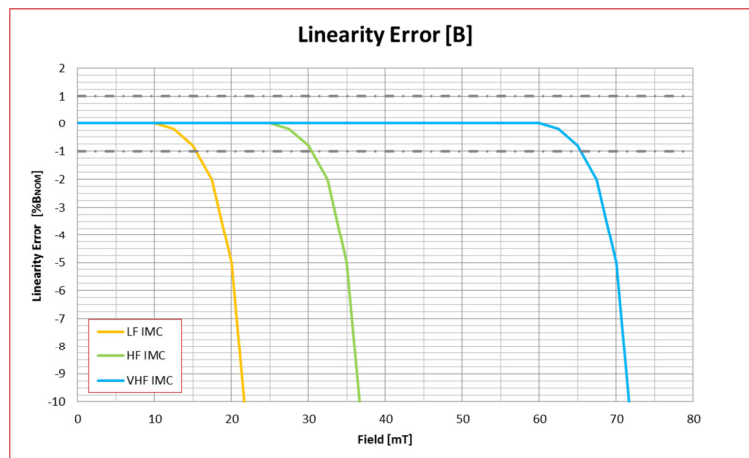

Figure 11: Linearity error for all versions.

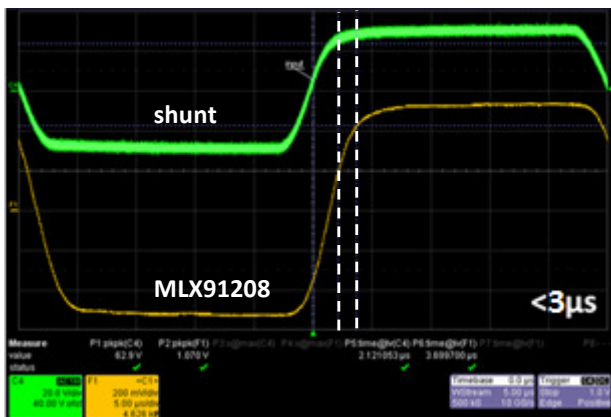

Figure 12: Response time with noise filter OFF.

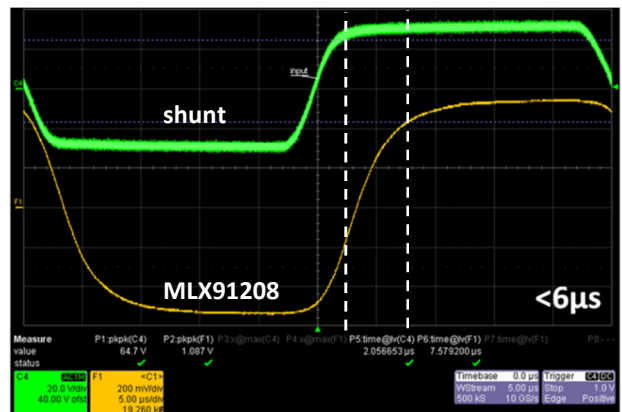

Figure 13: Response time with noise filter ON.

16. Standard information regarding manufacturability of Melexis products with different soldering processes

Melexis devices are qualified using state-of-the-art practices in accordance with automotive and environmental requirements.

Through qualifications, various soldering techniques are considered; please refer to “Soldering recommendations for Melexis products” for more information:

<https://www.melexis.com/en/documents/documentation/application-notes/application-note-soldering-recommendations>

For components normally soldered using Surface Mounted Device techniques (eg: Reflow process), Melexis has defined and qualified Moisture Sensitivity Level and Peak Temperature in accordance with the Jecdec J-STD-020 standard. Delivered material is conditioned accordingly. Moisture Sensitivity Level and Peak Temperature information can be found on the label identifying the material.

In case you intend to use a reflow soldering process for through hole devices (Melexis’ package codes: SA, UA, VA, VK, VM), please contact Melexis to verify your soldering process compatibility.

The application of Wave Soldering for SMD’s is allowed only after consulting Melexis regarding assurance of adhesive strength between device and board.

Based on Melexis commitment to environmental responsibility, Europe legislations (Direction on the Restriction of the Use of Certain Hazardous substances, RoHS) and customer requests, Melexis has deployed Pb free leadfinish (typically Matte Tin) on all ASSP products.

For through hole devices (Melexis’ package codes: SA, UA, VA, VK, VM) Trim&Form, please refer to “Trim & Form recommendations for Melexis products” for more information:

http://www.melexis.com/Assets/Trim_and_form_recommendations_DownloadLink_5565.aspx

17. ESD Precautions

Electronic semiconductor products are sensitive to Electro Static Discharge (ESD).

Always observe Electro Static Discharge control procedures whenever handling semiconductor products.

ESD HBM robustness is 2kV on external pins according to AEC-Q100-002 REV-D.

18. Package information

18.1. SOIC-8 Package Dimensions

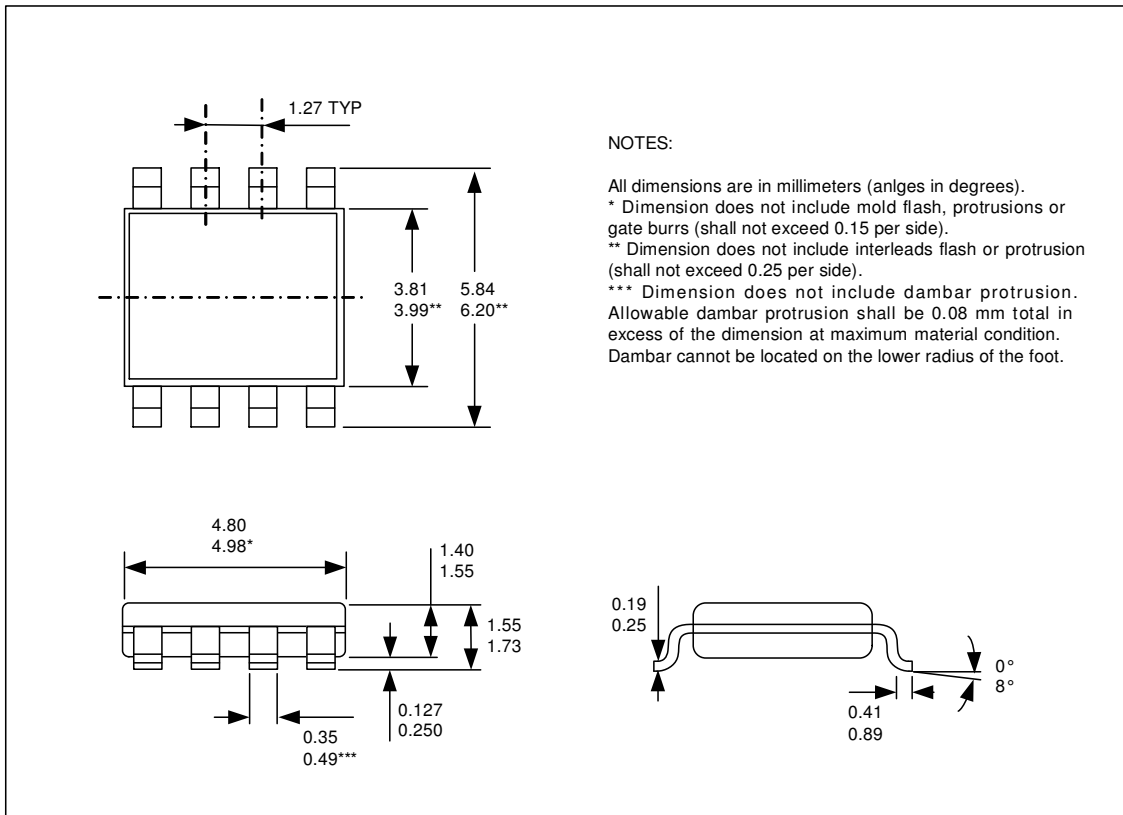

Figure 14: SOIC-8 Package dimensions

18.2. SOIC-8 Pinout and Marking

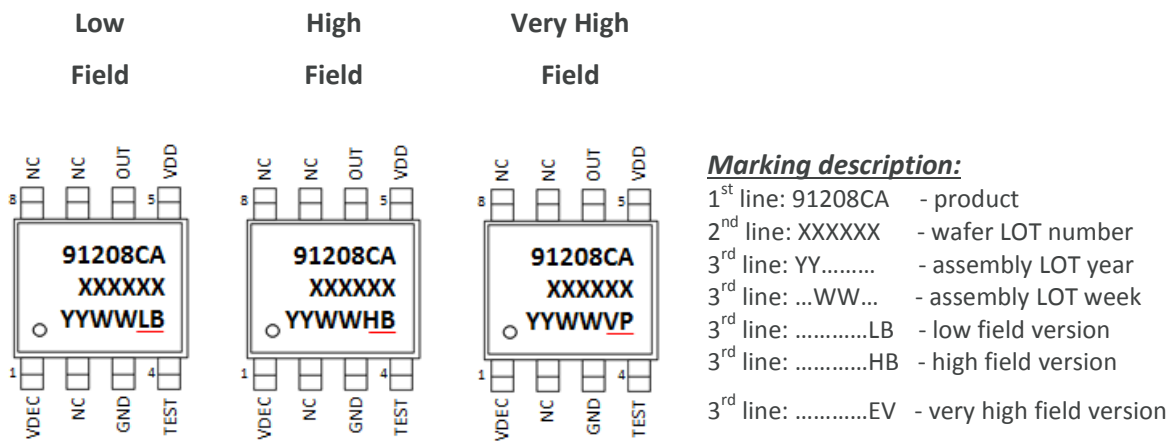

Figure 15: SOIC-8 Pinout and marking (Low Field, High Field and Very High Field version)

18.3. SOIC-8 Hall plate position

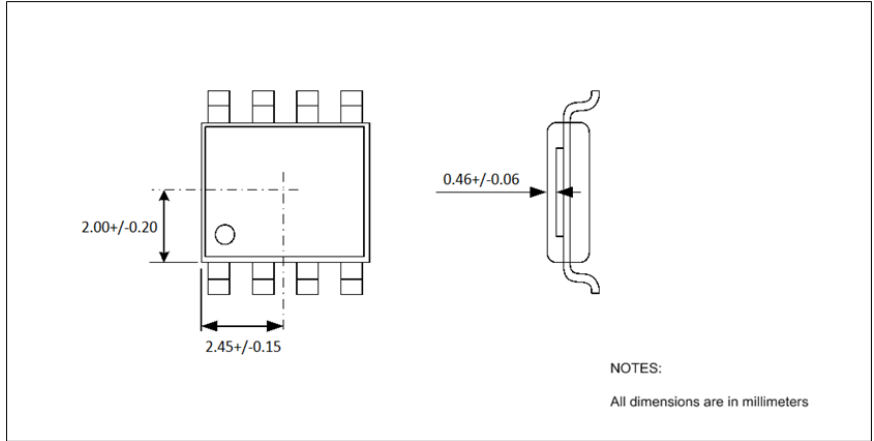

Figure 16: SOIC-8 Hall Plate positioning

18.4. SOIC-8 IMC Position and magnetic sensitive direction

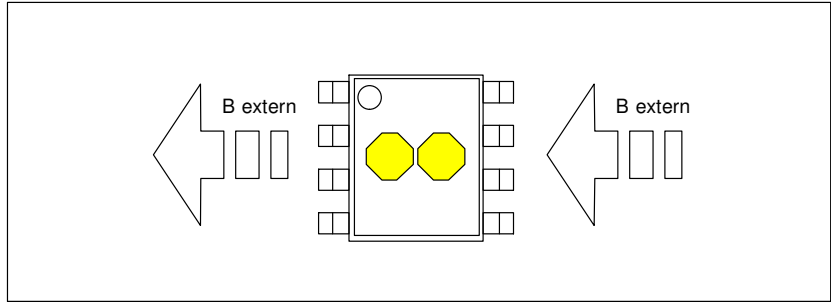

Figure 17: IMC position and geometry for low-field version

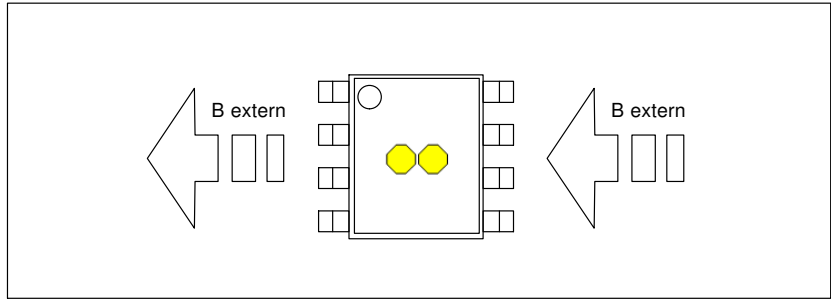

Figure 18: IMC position and geometry high-field version

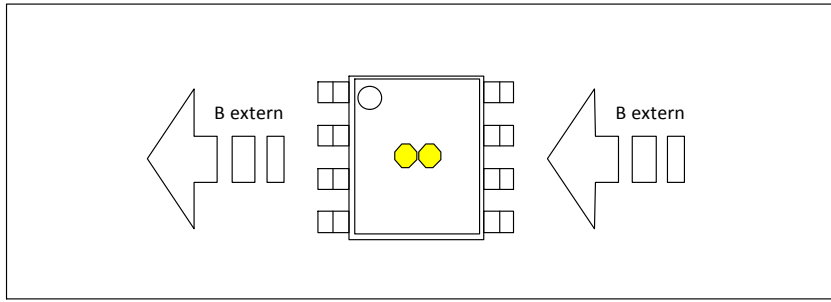

Figure 19: IMC position and geometry very high-field version

19. Contact

For the latest version of this document, go to our website at www.melexis.com.

For additional information, please contact our Direct Sales team and get help for your specific needs:

Europe, Africa	Telephone: +32 13 67 04 95
	Email : sales_europe@melexis.com
Americas	Telephone: +1 603 223 2362
	Email : sales_usa@melexis.com
Asia	Email : sales_asia@melexis.com

20. Disclaimer

The content of this document is believed to be correct and accurate. However, the content of this document is furnished "as is" for informational use only and no representation, nor warranty is provided by Melexis about its accuracy, nor about the results of its implementation. Melexis assumes no responsibility or liability for any errors or inaccuracies that may appear in this document. Customer will follow the practices contained in this document under its sole responsibility. This documentation is in fact provided without warranty, term, or condition of any kind, either implied or expressed, including but not limited to warranties of merchantability, satisfactory quality, non-infringement, and fitness for purpose. Melexis, its employees and agents and its affiliates' and their employees and agents will not be responsible for any loss, however arising, from the use of, or reliance on this document. Notwithstanding the foregoing, contractual obligations expressly undertaken in writing by Melexis prevail over this disclaimer.

This document is subject to change without notice, and should not be construed as a commitment by Melexis. Therefore, before placing orders or prior to designing the product into a system, users or any third party should obtain the latest version of the relevant information. Users or any third party must determine the suitability of the product described in this document for its application, including the level of reliability required and determine whether it is fit for a particular purpose.

This document as well as the product here described may be subject to export control regulations. Be aware that export might require a prior authorization from competent authorities. The product is not designed, authorized or warranted to be suitable in applications requiring extended temperature range and/or unusual environmental requirements. High reliability applications, such as medical life-support or life-sustaining equipment or avionics application are specifically excluded by Melexis. The product may not be used for the following applications subject to export control regulations: the development, production, processing, operation, maintenance, storage, recognition or proliferation of:

- 1. chemical, biological or nuclear weapons, or for the development, production, maintenance or storage of missiles for such weapons;*
- 2. civil firearms, including spare parts or ammunition for such arms;*
- 3. defense related products, or other material for military use or for law enforcement;*
- 4. any applications that, alone or in combination with other goods, substances or organisms could cause serious harm to persons or goods and that can be used as a means of violence in an armed conflict or any similar violent situation.*

No license nor any other right or interest is granted to any of Melexis' or third party's intellectual property rights.

If this document is marked "restricted" or with similar words, or if in any case the content of this document is to be reasonably understood as being confidential, the recipient of this document shall not communicate, nor disclose to any third party, any part of the document without Melexis' express written consent. The recipient shall take all necessary measures to apply and preserve the confidential character of the document. In particular, the recipient shall (i) hold document in confidence with at least the same degree of care by which it maintains the confidentiality of its own proprietary and confidential information, but no less than reasonable care; (ii) restrict the disclosure of the document solely to its employees, agents, professional advisors and contractors for the purpose for which this document was received, on a strictly need to know basis and providing that such persons to whom the document is disclosed are bound by confidentiality terms substantially similar to those in this disclaimer; (iii) use the document only in connection with the purpose for which this document was received, and reproduce document only to the extent necessary for such purposes; (iv) not use the document for commercial purposes or to the detriment of Melexis or its customers. The confidentiality obligations set forth in this disclaimer will have indefinite duration and in any case they will be effective for no less than 10 years from the receipt of this document.

This disclaimer will be governed by and construed in accordance with Belgian law and any disputes relating to this disclaimer will be subject to the exclusive jurisdiction of the courts of Brussels, Belgium.



The invalidity or ineffectiveness of any of the provisions of this disclaimer does not affect the validity or effectiveness of the other provisions. The previous versions of this document are repealed.

Melexis © - No part of this document may be reproduced without the prior written consent of Melexis. (2020)

IATF 16949 and ISO 14001 Certified

Looking for pricing, stock, or lifecycle information?

Click below to explore more details on WIN SOURCE:

-  [View MLX91208LDC-CAV-000-RE on WIN SOURCE](#)
-  [Melexis Technologies NV Information](#)

Optimize Your Supply Chain with WIN SOURCE Solutions

-  Global Sourcing Solution
-  Obsolete Management
-  Cost Control Management
-  Shortage Management
-  Alternative Solution
-  Excess Inventory Management