

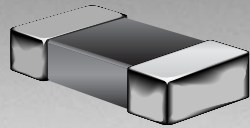

**THE DATASHEET OF  
MH3261-121Y**



\*RoHS COMPLIANT



**BOURNS®**

## Features

- High resistance to heat and humidity
- Resistance to mechanical shock and pressure
- Accurate dimensions for automatic surface mounting
- Wide impedance range



Models MH3225-151Y, -201Y, -300Y, -520Y, -650Y, and -900Y are currently available but not recommended for new designs.

## MH Series High Current Chip Ferrite Beads

### Electrical Specifications

Model Number	Impedance ( $\Omega$ ) at 100 MHz	RDC ( $m\Omega$ ) Max.	IDC (A) Max.
MH4532-700Y	70 $\pm$ 25 %	30	6.0
MH4532-800Y	80 $\pm$ 25 %	10	6.0
MH4532-121Y	120 $\pm$ 25 %	50	3.0
MH4532-131Y	130 $\pm$ 25 %	40	3.0
MH4532-151Y	150 $\pm$ 25 %	20	5.0
MH4532-681Y	680 $\pm$ 25 %	30	4.0
MH4532-132Y	1300 $\pm$ 25 %	60	3.0
MH4516-600Y	60 $\pm$ 25 %	10	6.0
MH4516-750Y	75 $\pm$ 25 %	25	3.0
MH4516-800Y	80 $\pm$ 25 %	50	3.0
MH4516-102Y	1000 $\pm$ 25 %	150	1.5
MH3261-190Y	19 $\pm$ 25 %	40	3.0
MH3261-260Y	26 $\pm$ 25 %	40	3.0
MH3261-310Y	31 $\pm$ 25 %	40	3.0
MH3261-500Y	50 $\pm$ 25 %	25	3.0
MH3261-700Y	70 $\pm$ 25 %	30	4.0
MH3261-800Y	80 $\pm$ 25 %	30	4.0
MH3261-900Y	90 $\pm$ 25 %	40	3.0
MH3261-101Y	100 $\pm$ 25 %	30	4.0
MH3261-121Y	120 $\pm$ 25 %	100	2.0
MH3261-151Y	150 $\pm$ 25 %	100	2.0
MH3261-301Y	300 $\pm$ 25 %	200	1.0
MH3261-471Y	470 $\pm$ 25 %	200	1.0
MH3261-501Y	500 $\pm$ 25 %	40	3.0
MH3261-601Y	600 $\pm$ 25 %	100	2.0
MH3225-300Y	30 $\pm$ 25 %	50	3.0
MH3225-520Y	52 $\pm$ 25 %	50	3.0
MH3225-650Y	65 $\pm$ 25 %	30	3.0
MH3225-900Y	90 $\pm$ 25 %	100	2.0
MH3225-151Y	150 $\pm$ 25 %	20	5.0
MH3225-201Y	200 $\pm$ 25 %	30	4.0
MH2029-070Y	7 $\pm$ 25 %	30	3.0
MH2029-100Y	10 $\pm$ 25 %	10	6.0
MH2029-300Y	30 $\pm$ 25 %	25	3.0
MH2029-400Y	40 $\pm$ 25 %	20	5.0
MH2029-600Y	60 $\pm$ 25 %	20	5.0
MH2029-800Y	80 $\pm$ 25 %	40	3.0
MH2029-101Y	100 $\pm$ 25 %	100	2.0
MH2029-121Y	120 $\pm$ 25 %	100	2.0
MH2029-151Y	150 $\pm$ 25 %	100	2.0
MH2029-221Y	220 $\pm$ 25 %	100	2.0
MH2029-301Y	300 $\pm$ 25 %	200	1.0
MH2029-401Y	400 $\pm$ 25 %	100	2.0
MH2029-471Y	470 $\pm$ 25 %	200	1.0
MH2029-601Y	600 $\pm$ 25 %	200	1.0
MH1608-100Y	10 $\pm$ 25 %	100	6.0
MH1608-300Y	30 $\pm$ 25 %	60	3.0
MH1608-600Y	60 $\pm$ 25 %	40	3.0
MH1608-800Y	80 $\pm$ 25 %	40	3.0
MH1608-101Y	100 $\pm$ 25 %	40	3.0
MH1608-121Y	120 $\pm$ 25 %	100	2.0
MH1608-151Y	150 $\pm$ 25 %	100	2.0
MH1608-221Y	220 $\pm$ 25 %	100	2.0
MH1608-301Y	300 $\pm$ 25 %	200	1.0
MH1608-471Y	470 $\pm$ 25 %	200	1.0
MH1608-601Y	600 $\pm$ 25 %	200	1.0

### General Specifications

Operating Temperature .....-55 °C to +125 °C  
 Storage Temperature...-55 °C to +125 °C  
 Storage Condition .....+40 °C max. at 70 % RH  
 Reflow Soldering .....230 °C, 50 seconds max.  
 Resistance to Soldering Heat .....260 °C, 5 seconds  
 Rated Current .....Based on max. temperature rise of +40 °C  
 Terminal Strength (Force "F" applied for 30 seconds)  
 4532 Series .....1.5 F (Kg)  
 4516 Series .....1.0 F (Kg)  
 3261 Series .....1.0 F (Kg)  
 3225 Series .....1.0 F (Kg)  
 2029 Series .....0.6 F (Kg)  
 1608 Series .....0.5 F (Kg)

### Materials

Core Material .....Ferrite  
 Internal Conductor .....Ag or Ag/Pd  
 Terminal .....Ag/Ni/Sn

\*RoHS Directive 2002/95/EC Jan 27, 2003 including Annex. Specifications are subject to change without notice. Customers should verify actual device performance in their specific applications.

## Applications

- Power supply lines
- IC power lines
- Signal lines

# MH Series High Current Chip Ferrite Beads

**BOURNS®**

### Electrical Specifications (continued)

**MH 4532- 700Y**

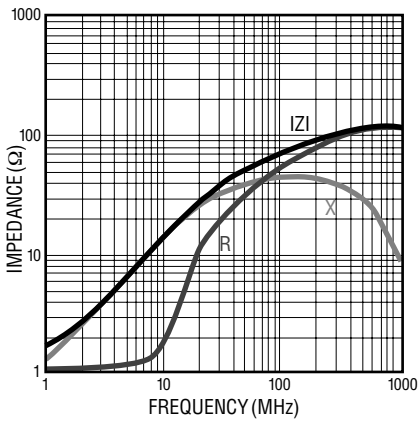

**MH 4532- 800Y**

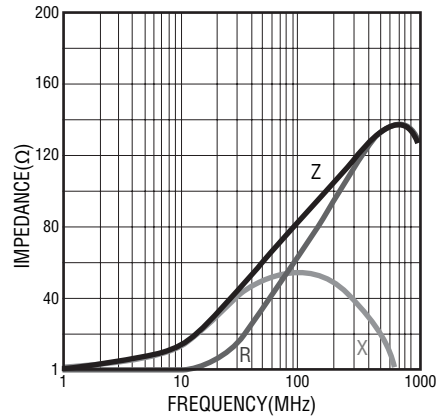

**MH 4532- 121Y**

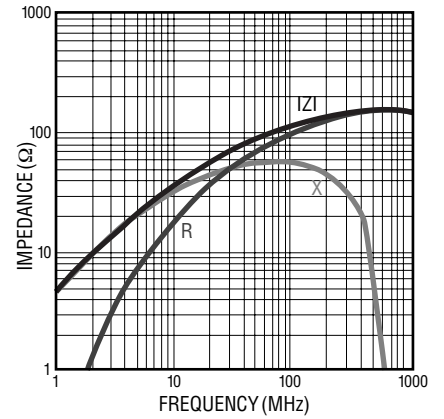

**MH 4532- 131Y**

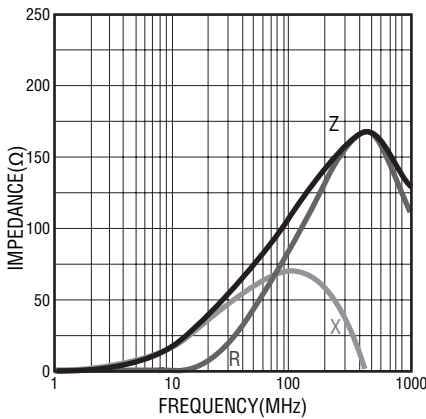

**MH 4532- 151Y**

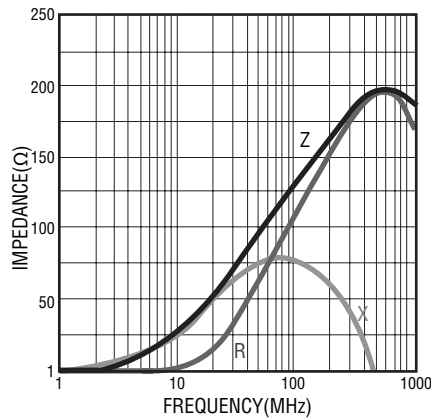

**MH 4532- 681Y**

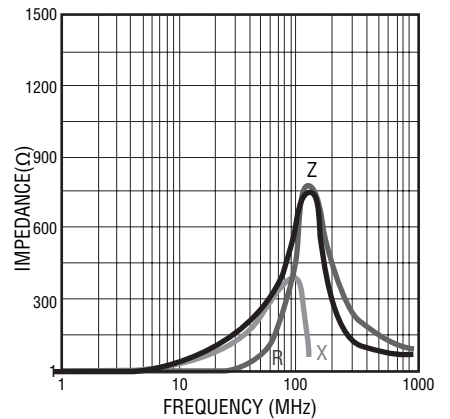

**MH 4532- 132Y**

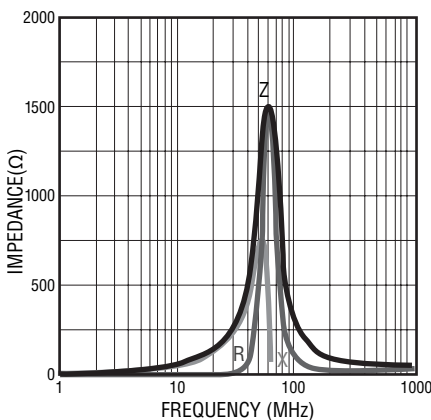

**MH 4516- 600Y**

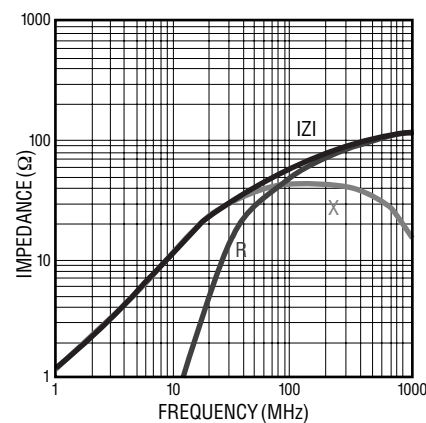

**MH 4516- 750Y**

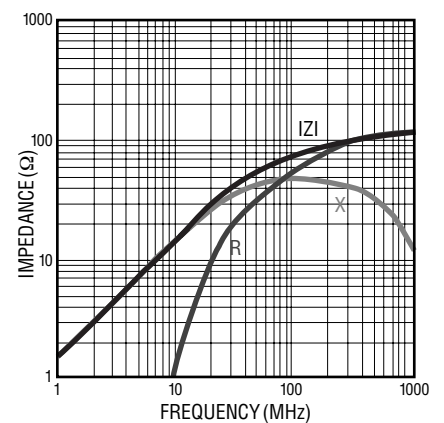

Specifications are subject to change without notice.  
Customers should verify actual device performance in their specific applications.

# MH Series High Current Chip Ferrite Beads

**BOURNS®**

## Electrical Specifications (continued)

**MH 4516- 800Y**

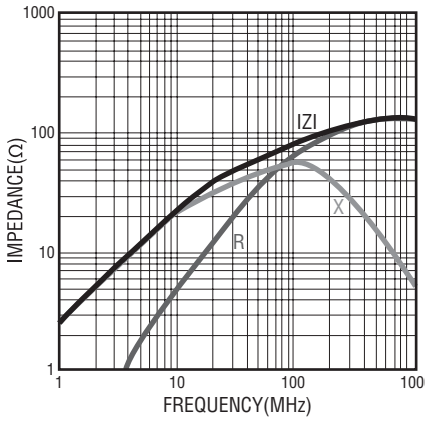

**MH 4516- 101Y**

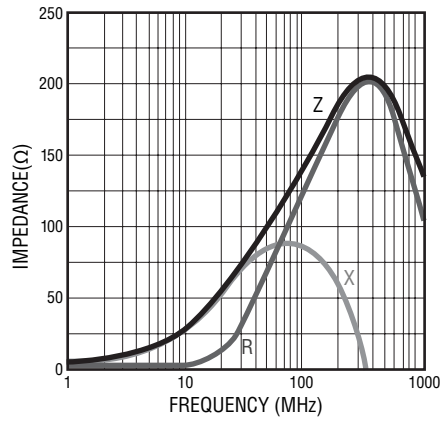

**MH 4516- 102Y**

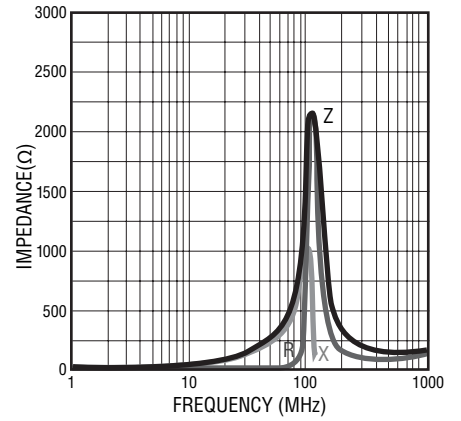

**MH 3261- 190Y**

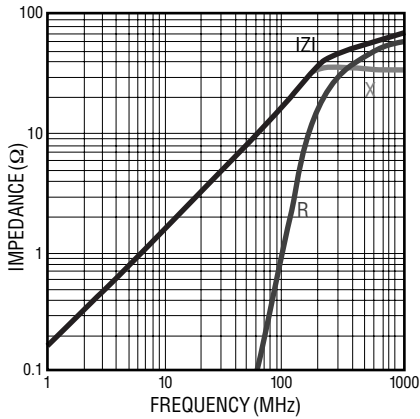

**MH 3261- 260Y**

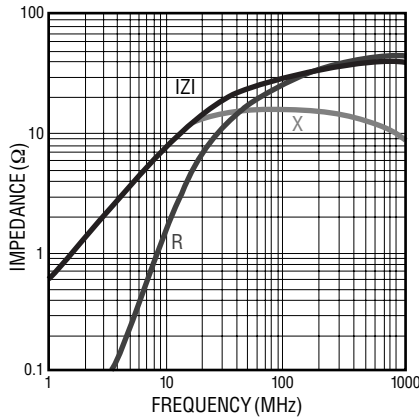

**MH 3261- 310Y**

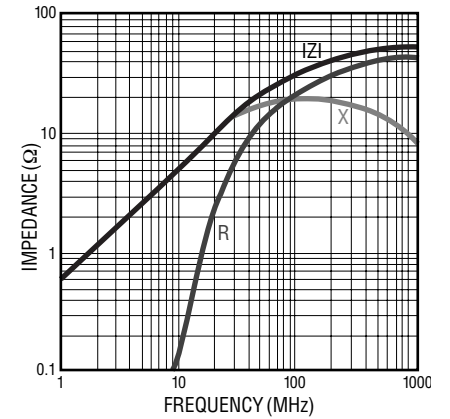

**MH 3261- 500Y**

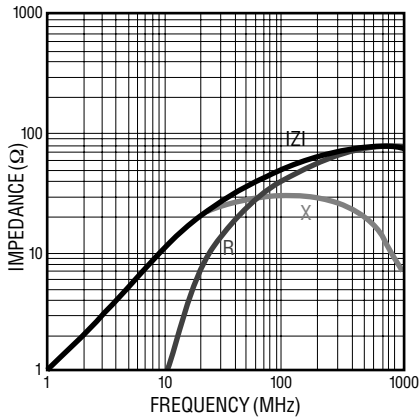

**MH 3261- 700Y**

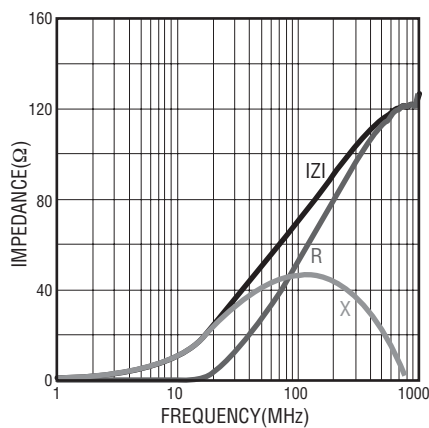

**MH 3261- 800Y**

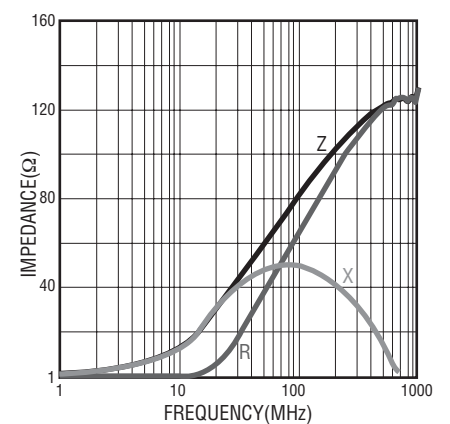

Specifications are subject to change without notice. Customers should verify actual device performance in their specific applications.

# MH Series High Current Chip Ferrite Beads

**BOURNS®**

## Electrical Specifications (continued)

**MH 3261- 900Y**

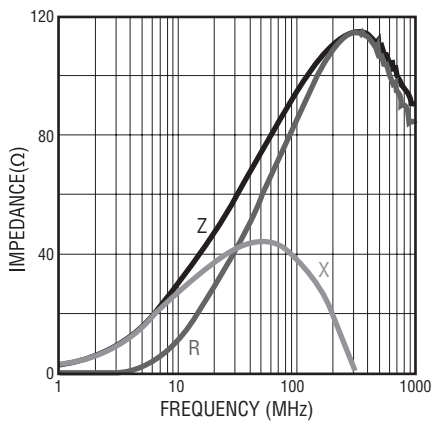

**MH 3261- 101Y**

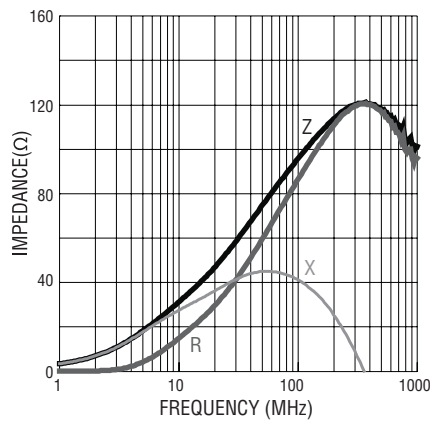

**MH 3261- 121Y**

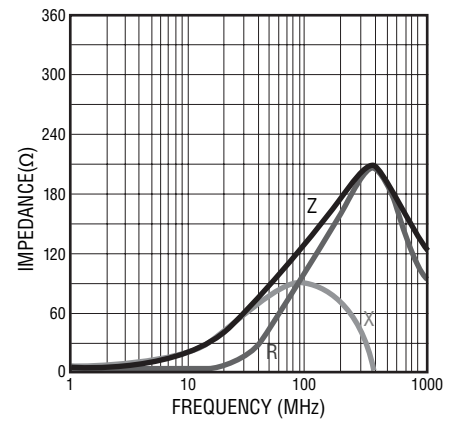

**MH 3261- 151Y**

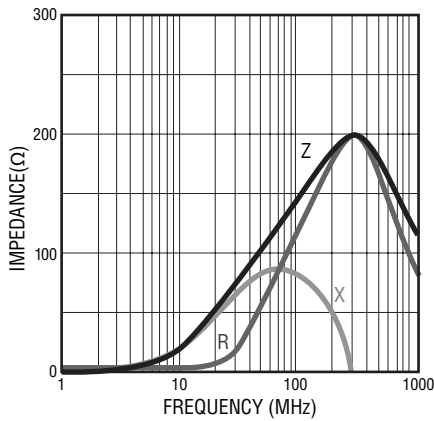

**MH 3261- 301Y**

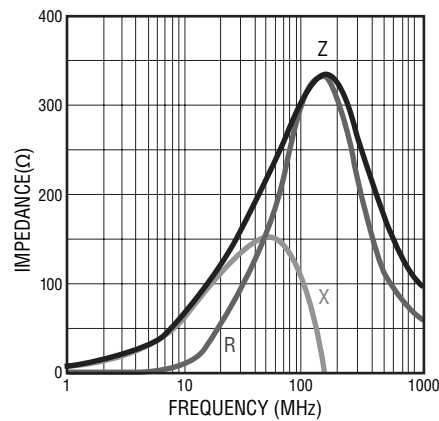

**MH 3261- 471Y**

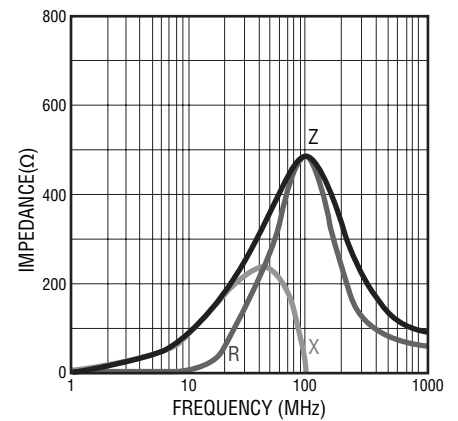

**MH 3261- 501Y**

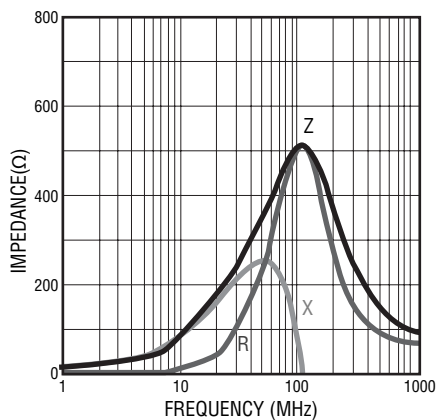

**MH 3261- 601Y**

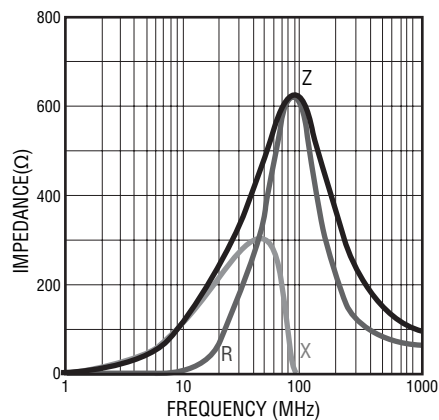

**MH 3225- 300Y**

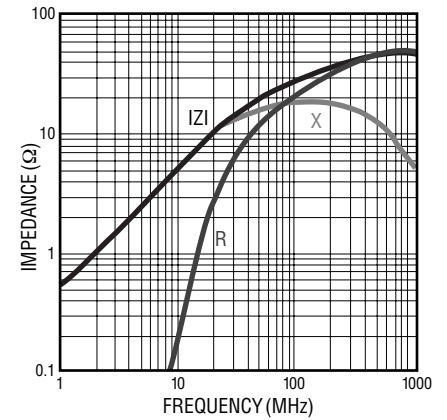

Specifications are subject to change without notice.  
Customers should verify actual device performance in their specific applications.

# MH Series High Current Chip Ferrite Beads

**BOURNS®**

## Electrical Specifications (continued)

**MH 3225- 520Y**

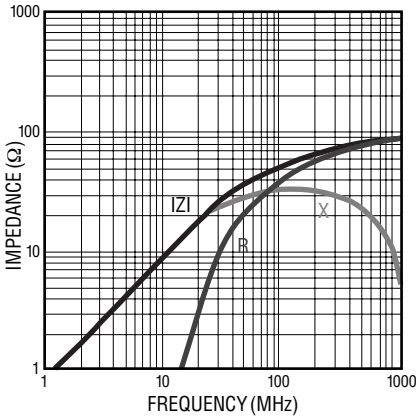

**MH 3225- 650Y**

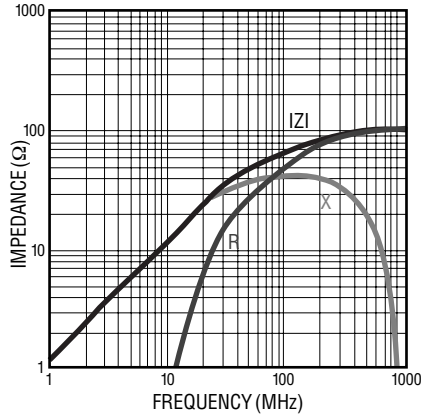

**MH 3225- 900Y**

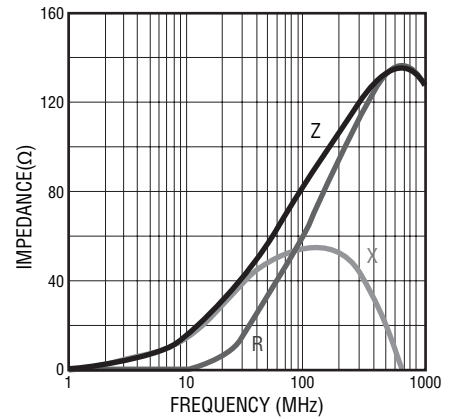

**MH 3225- 151Y**

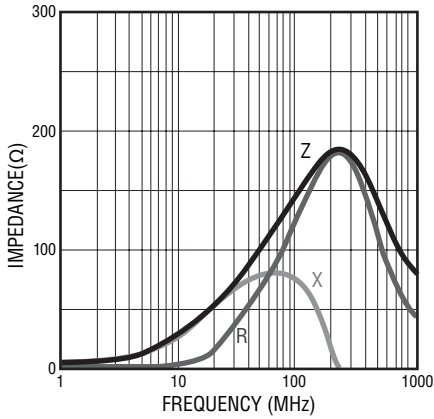

**MH 3225- 201Y**

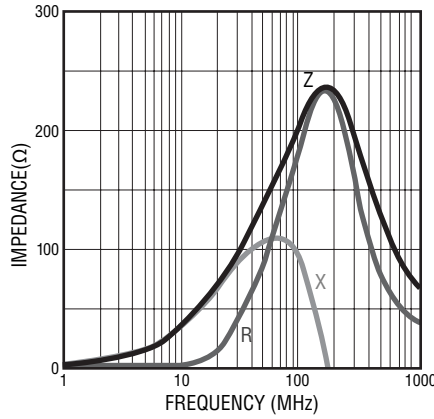

**MH 2029- 070Y**

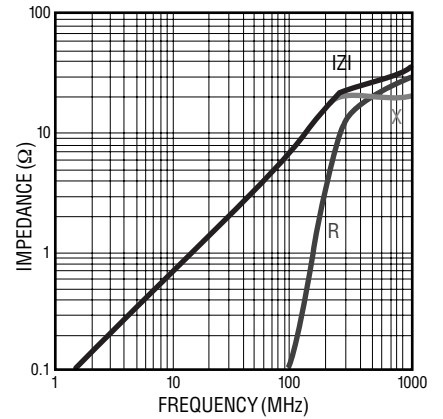

**MH 2029- 100Y**

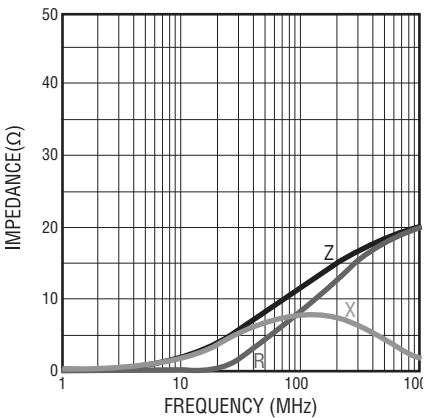

**MH 2029- 300Y**

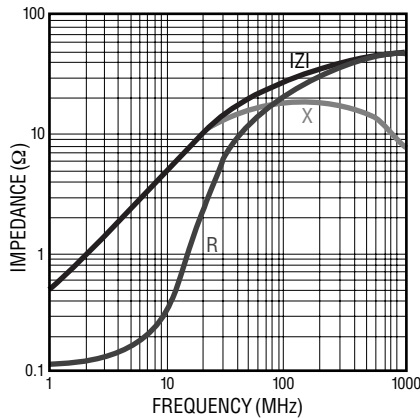

**MH 2029 -400Y**

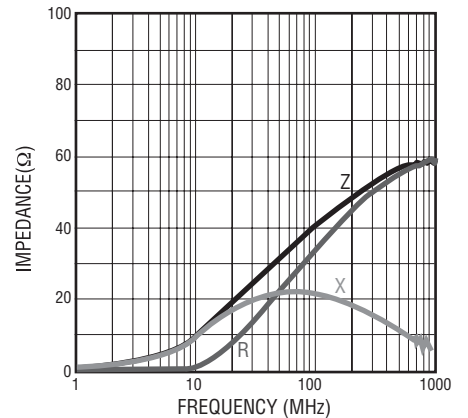

Specifications are subject to change without notice. Customers should verify actual device performance in their specific applications.

# MH Series High Current Chip Ferrite Beads

**BOURNS®**

## Electrical Specifications (continued)

**MH 2029 -600Y**

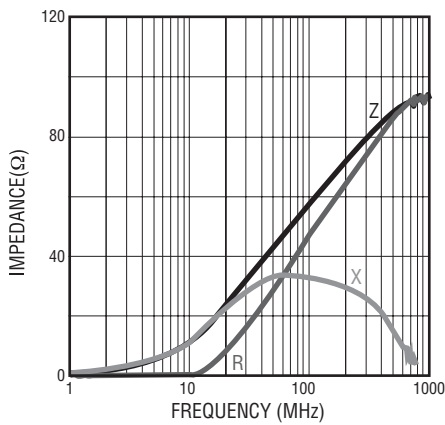

**MH 2029- 800Y**

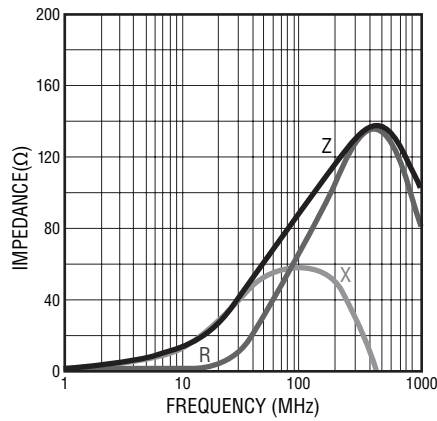

**MH 2029- 101Y**

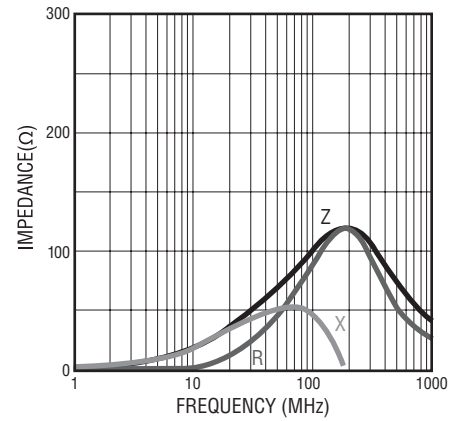

**MH 2029- 121Y**

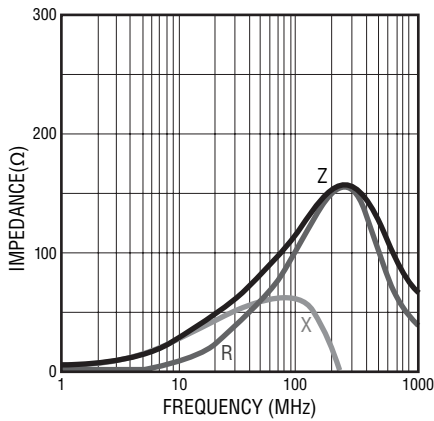

**MH 2029- 151Y**

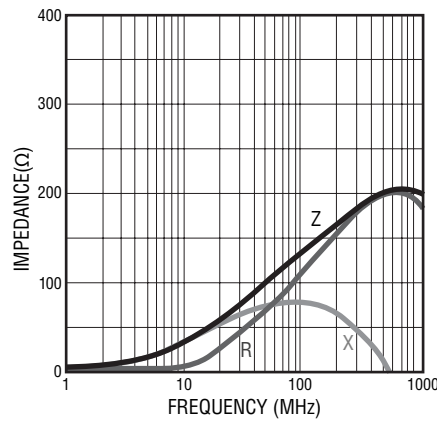

**MH 2029- 221Y**

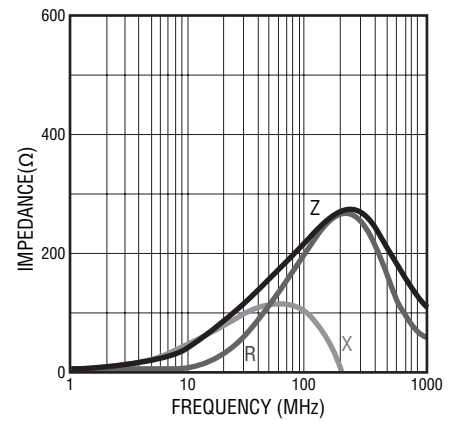

**MH 2029- 301Y**

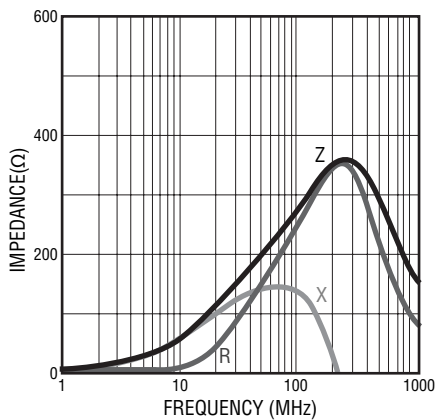

**MH 2029 -401Y**

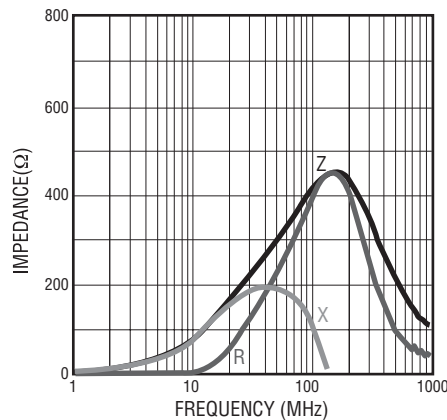

**MH 2029- 471Y**

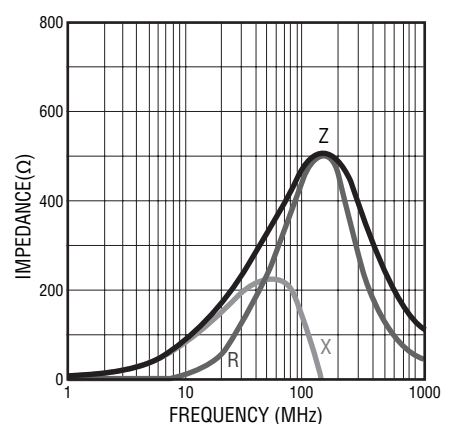

Specifications are subject to change without notice.  
Customers should verify actual device performance in their specific applications.

# MH Series High Current Chip Ferrite Beads

**BOURNS®**

## Electrical Specifications (continued)

**MH 2029- 601Y**

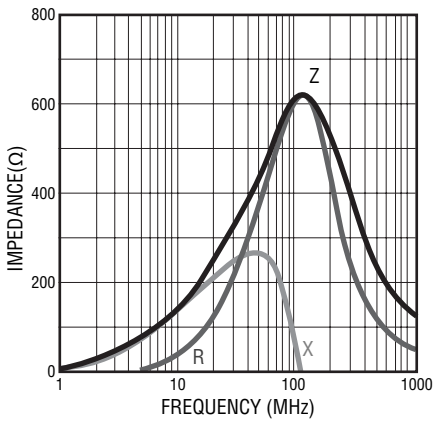

**MH 1608 -100Y**

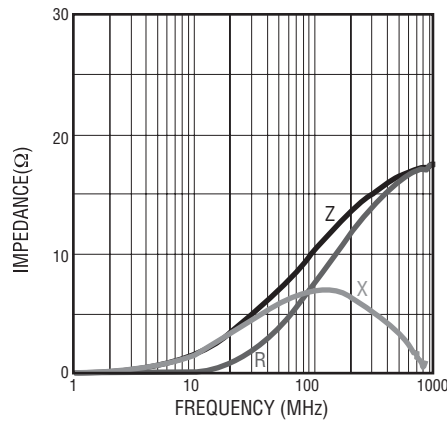

**MH 1608- 300Y**

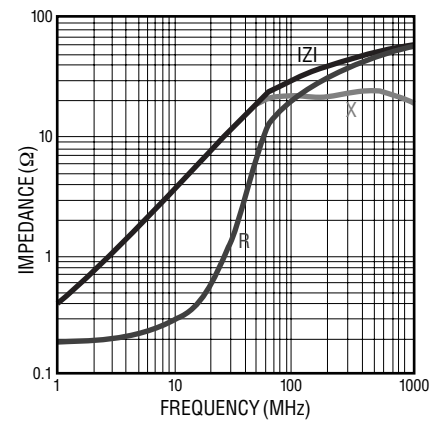

**MH 1608 -600Y**

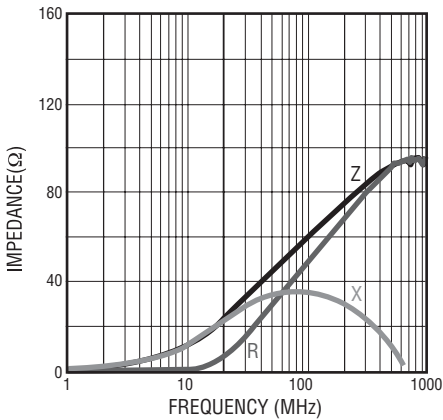

**MH 1608- 800Y**

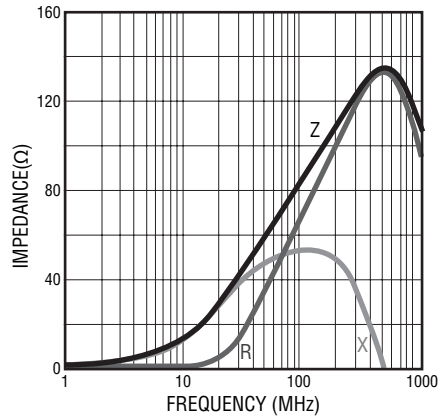

**MH 1608- 101Y**

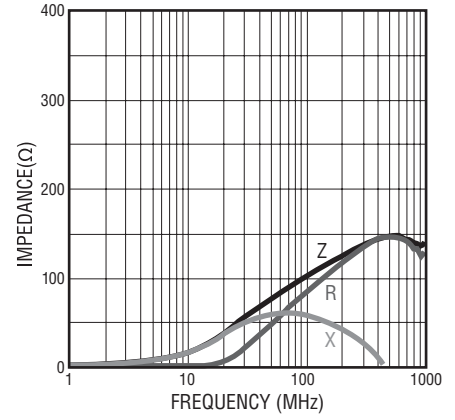

**MH 1608- 121Y**

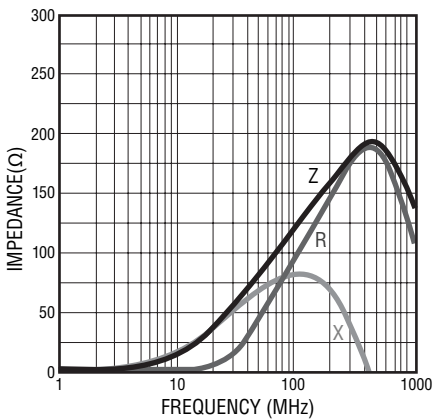

**MH 1608- 151Y**

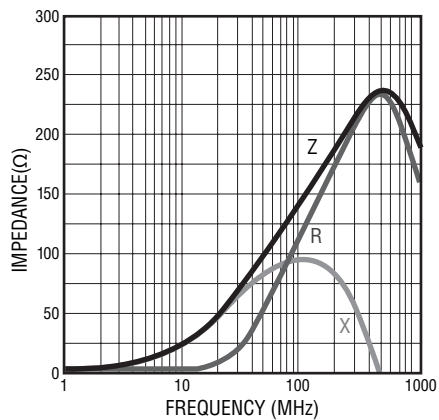

**MH 1608- 221Y**

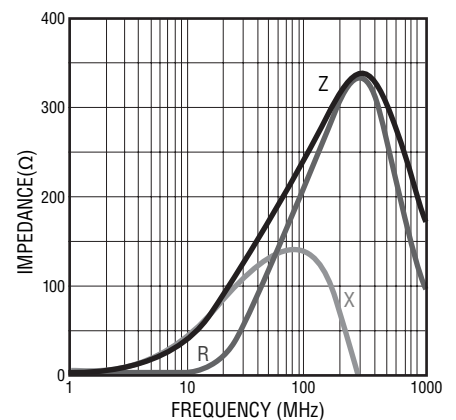

Specifications are subject to change without notice. Customers should verify actual device performance in their specific applications.

# MH Series High Current Chip Ferrite Beads

**BOURNS®**

## Electrical Specifications (continued)

**MH 1608- 301Y**

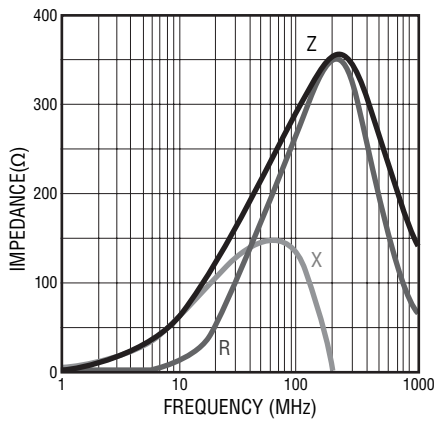

**MH 1608- 471Y**

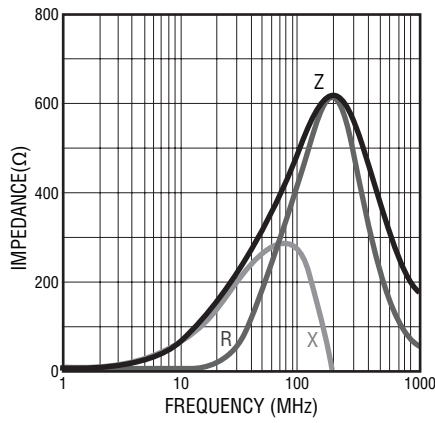

**MH 1608- 601Y**

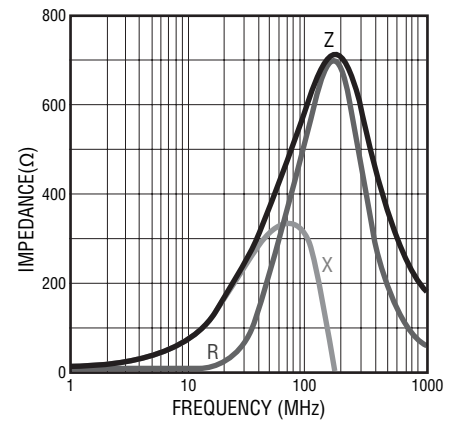

## Equivalent Circuit

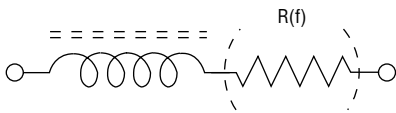

## Recommended Soldering

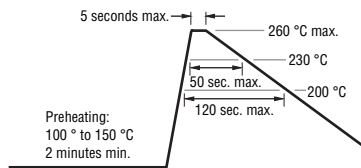

# MH Series High Current Chip Ferrite Beads

**BOURNS®**

## Product Dimensions

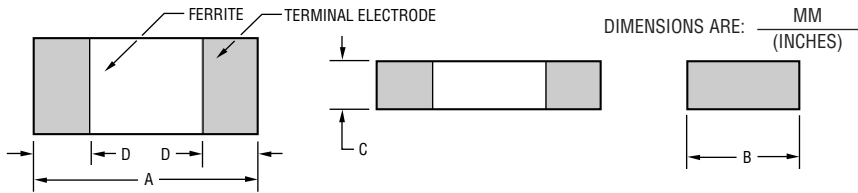

## Recommended Land Pattern

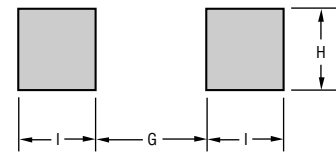

Series	A	B	C	D	G	H	I
4532	$\frac{4.5 \pm 0.2}{(.177 \pm .008)}$	$\frac{3.2 \pm 0.2}{(.126 \pm .008)}$	$\frac{1.5 \pm 0.2}{(.059 \pm .008)}$	$\frac{0.5 \pm 0.2}{(.020 \pm .008)}$	$\frac{3.0}{(.118)}$	$\frac{3.0}{(.118)}$	$\frac{1.5}{(.059)}$
4516	$\frac{4.5 \pm 0.2}{(.177 \pm .008)}$	$\frac{1.6 \pm 0.2}{(.063 \pm .008)}$	$\frac{1.6 \pm 0.2}{(.063 \pm .008)}$	$\frac{0.5 \pm 0.2}{(.020 \pm .008)}$	$\frac{3.0}{(.118)}$	$\frac{1.4}{(.055)}$	$\frac{1.5}{(.059)}$
3261	$\frac{3.2 \pm 0.2}{(.126 \pm .008)}$	$\frac{1.6 \pm 0.2}{(.063 \pm .008)}$	$\frac{1.1 \pm 0.2}{(.043 \pm .008)}$	$\frac{0.5 \pm 0.2}{(.020 \pm .008)}$	$\frac{2.0}{(.079)}$	$\frac{1.4}{(.053)}$	$\frac{1.1}{(.043)}$
3225	$\frac{3.2 \pm 0.2}{(.126 \pm .008)}$	$\frac{2.5 \pm 0.2}{(.098 \pm .008)}$	$\frac{1.3 \pm 0.2}{(.051 \pm .008)}$	$\frac{0.5 \pm 0.2}{(.020 \pm .008)}$	$\frac{2.2}{(.118)}$	$\frac{2.3}{(.091)}$	$\frac{1.1}{(.043)}$
2029	$\frac{2.0 \pm 0.2}{(.079 \pm .008)}$	$\frac{1.2 \pm 0.2}{(.047 \pm .008)}$	$\frac{0.9 \pm 0.2}{(.035 \pm .008)}$	$\frac{0.5 \pm 0.2}{(.020 \pm .008)}$	$\frac{1.0}{(.040)}$	$\frac{1.0}{(.040)}$	$\frac{1.0}{(.040)}$
1608	$\frac{1.6 \pm 0.2}{(.063 \pm .008)}$	$\frac{0.8 \pm 0.2}{(.031 \pm .008)}$	$\frac{0.8 \pm 0.2}{(.031 \pm .008)}$	$\frac{0.5 \pm 0.2}{(.020 \pm .008)}$	$\frac{0.7}{(.028)}$	$\frac{0.7}{(.128)}$	$\frac{0.7}{(.128)}$

## Reel Dimensions

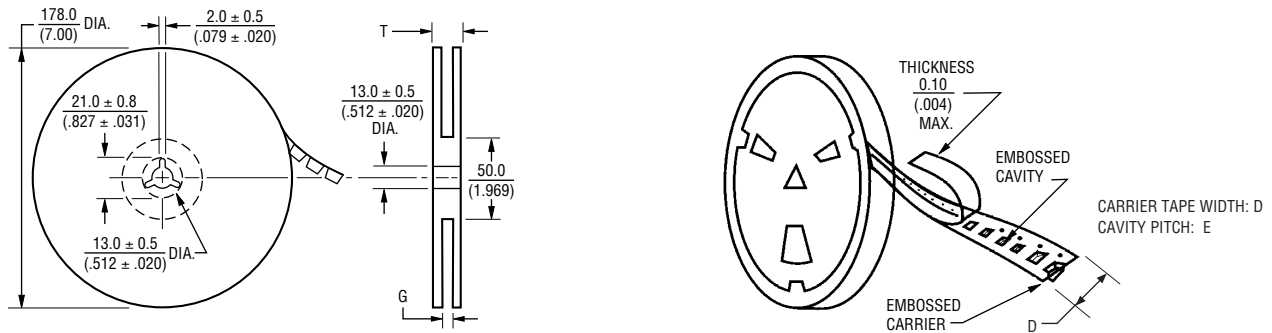

Series	Pcs. per Reel	Gross Weight (g)	D	E	G	T
4532	1,000	170	$\frac{12.0}{(.472)}$	$\frac{8.0}{(.315)}$	$\frac{14.0 + 0}{(.551 + 0)}$	$\frac{16.5}{(.650)}$
4516	2,000	180	$\frac{12.0}{(.472)}$	$\frac{8.0}{(.315)}$	$\frac{14.0 + 0}{(.551 + 0)}$	$\frac{16.5}{(.650)}$
3261	3,000	150	$\frac{8.0}{(.315)}$	$\frac{4.0}{(.157)}$	$\frac{10.0 + 0}{(.394 + 0)}$	$\frac{12.5}{(.492)}$
3225	2,500	160	$\frac{8.0}{(.315)}$	$\frac{4.0}{(.157)}$	$\frac{10.0 + 0}{(.394 + 0)}$	$\frac{12.5}{(.492)}$
2029	4,000	120	$\frac{8.0}{(.315)}$	$\frac{4.0}{(.157)}$	$\frac{10.0 + 0}{(.394 + 0)}$	$\frac{12.5}{(.492)}$
1608	4,000	90	$\frac{8.0}{(.315)}$	$\frac{4.0}{(.157)}$	$\frac{10.0 + 0}{(.394 + 0)}$	$\frac{12.5}{(.492)}$



## Features

- High resistance to heat and humidity
- Resistance to mechanical shock and pressure
- Accurate dimensions for automatic surface mounting
- Wide impedance range



Models MG1608-202Y, -222Y and MZ1608-152Y, -202Y, -152Y, -202Y, -122Y and -202Y are currently available but not recommended for new designs.

## MG, MU, MZ Series High Impedance Chip Ferrite Beads

### Electrical Specifications

Model Number	Impedance (Ω) at 100 MHz	RDC (Ω) Max.	IDC (mA) Max.
MU3261-300Y	30 ±25 %	0.20	500
MU3261-600Y	60 ±25 %	0.20	400
MU3261-750Y	75 ±25 %	0.20	400
MU3261-101Y	100 ±25 %	0.15	500
MU3261-121Y	120 ±25 %	0.15	900
MG3261-151Y	150 ±25 %	0.30	300
MU3261-221Y	220 ±25 %	0.35	700
MG3261-301Y	300 ±25 %	0.30	300
MU3261-301Y	300 ±25 %	0.30	300
MU3261-471Y	470 ±25 %	0.35	400
MU3261-601Y	600 ±25 %	0.30	200
MZ3261-601Y	600 ±25 %	0.30	200
MU3261-801Y	800 ±25 %	0.60	300
MU3261-102Y	1000 ±25 %	0.60	100
MZ3261-122Y	1200 ±25 % (at 50 MHz)	0.50	100
MU3261-122Y	1200 ±25 % (at 50 MHz)	0.50	100
MU3261-152Y	1500 ±25 % (at 50 MHz)	0.70	300
MZ3261-202Y	2000 ±25 % (at 30 MHz)	0.60	100
MU3261-202Y	2000 ±25 % (at 30 MHz)	0.60	100
MG2029-100Y	10 ±25 %	0.20	400
MG2029-300Y	30 ±25 %	0.10	400
MG2029-400Y	40 ±25 %	0.20	300
MU2029-600Y	60 ±25 %	0.10	900
MG2029-800Y	80 ±25 %	0.20	300
MG2029-101Y	100 ±25 %	0.20	400
MG2029-121Y	120 ±25 %	0.25	300
MU2029-151Y	150 ±25 %	0.20	800
MU2029-221Y	220 ±25 %	0.30	500
MU2029-301Y	300 ±25 %	0.30	500
MU2029-471Y	470 ±25 %	0.35	700
MZ2029-601Y	600 ±25 %	0.40	100
MZ2029-601T	600 ±25 %	0.40	200
MZ2029-102Y	1000 ±25 %	0.45	100
MZ2029-152Y	1500 ±25 %	0.55	100
MZ2029-202Y	2000 ±25 %	0.60	50
MG1608-300Y	30 ±25 %	0.20	200
MG1608-400Y	40 ±25 %	0.30	300
MU1608-600Y	60 ±25 %	0.20	700
MG1608-800Y	80 ±25 %	0.30	300
MG1608-101Y	100 ±25 %	0.25	200
MG1608-121Y	120 ±25 %	0.30	200
MU1608-151Y	150 ±25 %	0.25	600
MU1608-221Y	220 ±25 %	0.30	200
MU1608-301Y	300 ±25 %	0.35	150
MU1608-471Y	470 ±25 %	0.45	350
MZ1608-601Y	600 ±25 %	0.45	100
MZ1608-102Y	1000 ±25 %	0.60	100
MZ1608-152Y	1500 ±25 %	0.70	50
MG1608-202Y	2000 ±25 %	0.80	50
MG1608-222Y	2200 ±25 %	1.50	200
MU1005-100Y	10 ±25 %	0.10	500
MU1005-300Y	30 ±25 %	0.20	300
MU1005-600Y	60 ±25 %	0.25	300
MU1005-121Y	120 ±25 %	0.30	100
MU1005-151Y	150 ±25 %	0.30	100
MU1005-221Y	220 ±25 %	0.40	100
MU1005-241Y	240 ±25 %	0.60	100
MU1005-301Y	300 ±25 %	0.50	100
MU1005-471Y	470 ±25 %	0.65	100
MU1005-601Y	600 ±25 %	0.80	80
MU1005-102Y	1000 ±25 %	1.20	80

### General Specifications

Operating Temperature .....-55 °C to +125 °C  
 Storage Temperature ..-55 °C to +125 °C  
 Storage Condition .....+40 °C max. at 70 % RH  
 Reflow Soldering .....230 °C, 50 seconds max.  
 Resistance to Soldering Heat .....260 °C, 5 seconds  
 Rated Current .....Based on max. temperature rise of +40 °C  
 Terminal Strength (Force "F" applied for 30 seconds)  
 3261 Series .....1.0 F (Kg)  
 2029 Series .....0.6 F (Kg)  
 1608 Series .....0.5 F (Kg)

### Materials

Core Material .....Ferrite  
 Internal Conductor .....Ag or Ag/Pd  
 Terminal .....Ag/Ni/Sn

\*RoHS Directive 2002/95/EC Jan 27, 2003 including Annex. Specifications are subject to change without notice. Customers should verify actual device performance in their specific applications.

## Applications

- Power supply lines
- IC power lines
- Signal lines

# MG, MU, MZ Series High Impedance Chip Ferrite Beads

**BOURNS®**

### Electrical Specifications (continued)

**MU 3261- 300Y**

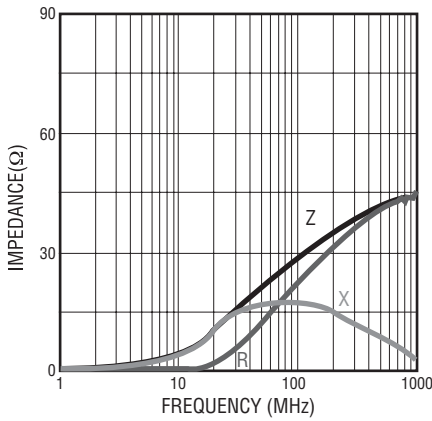

**MU 3261- 600Y**

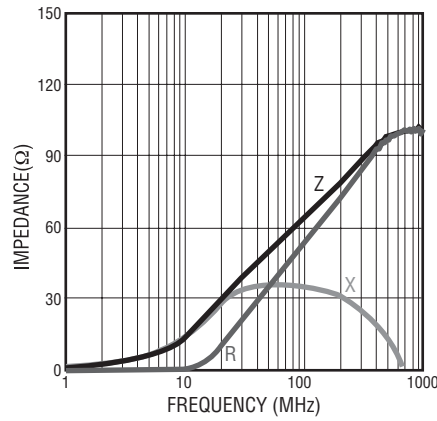

**MU 3261- 750Y**

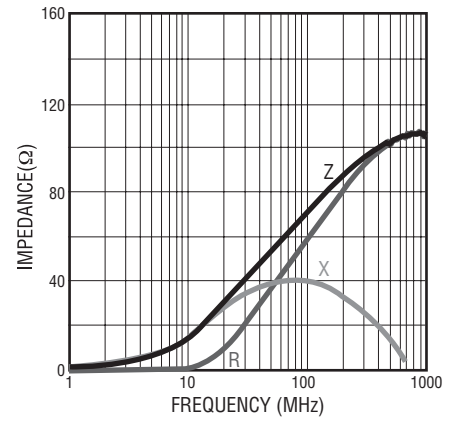

**MU 3261- 101Y**

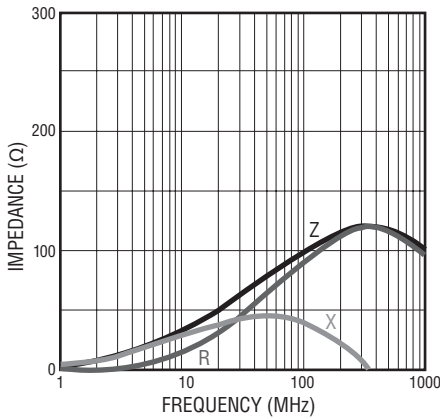

**MU 3261- 121Y**

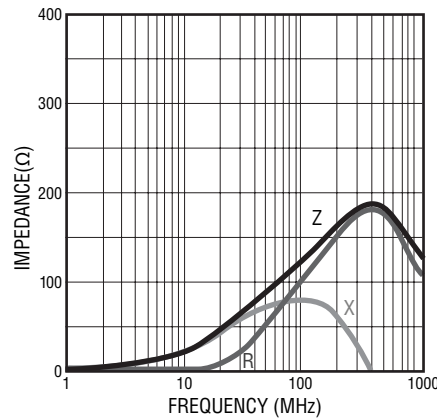

**MG 3261- 151Y**

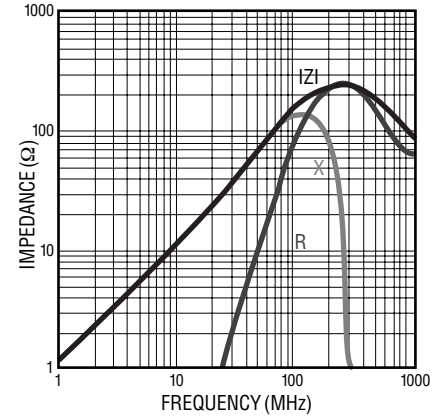

**MU 3261- 221Y**

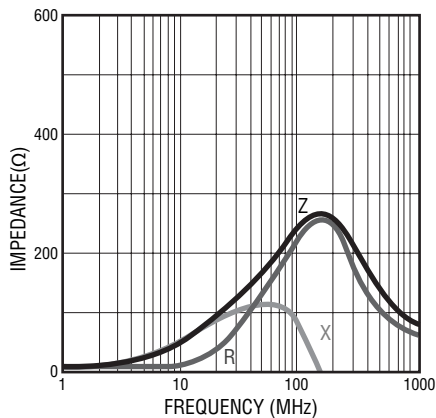

**MG 3261- 301Y**

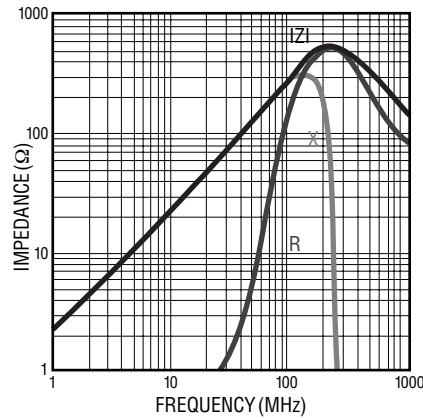

**MU 3261- 301Y**

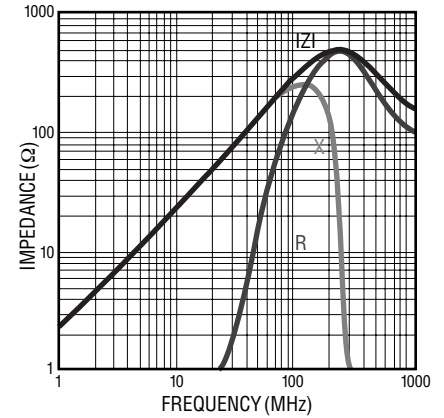

Specifications are subject to change without notice.  
Customers should verify actual device performance in their specific applications.

# MG, MU, MZ Series High Impedance Chip Ferrite Beads

**BOURNS®**

## Electrical Specifications (continued)

**MU 3261- 471Y**

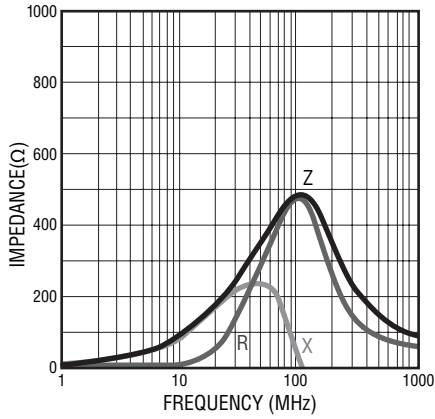

**MU 3261- 601Y**

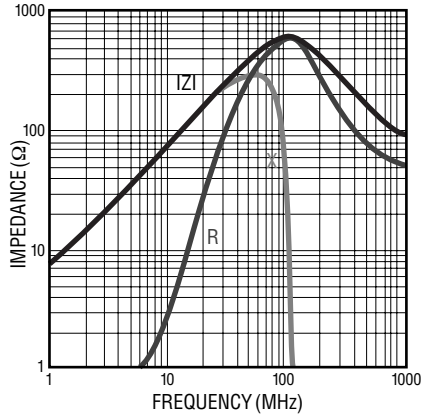

**MZ 3261- 601Y**

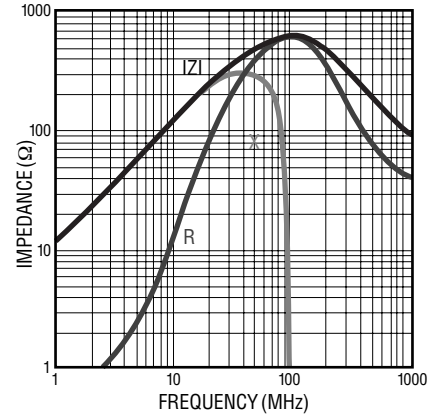

**MU 3261- 801Y**

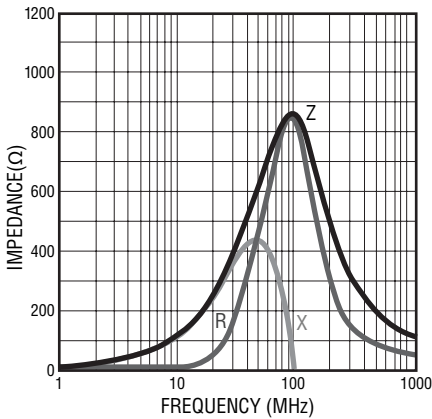

**MZ 3261- 122Y**

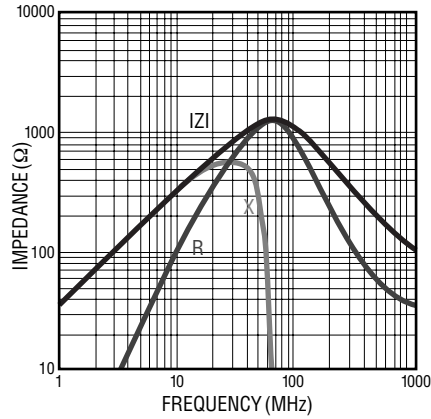

**MU 3261- 102Y**

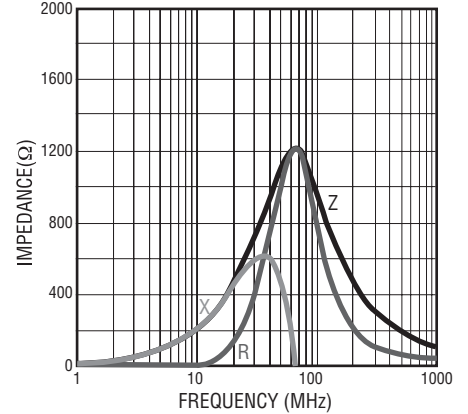

**MU 3261- 122Y**

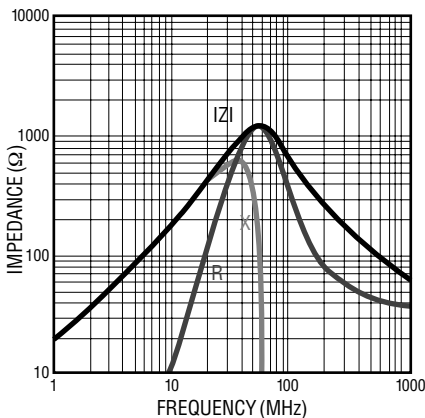

**MU 3261- 152Y**

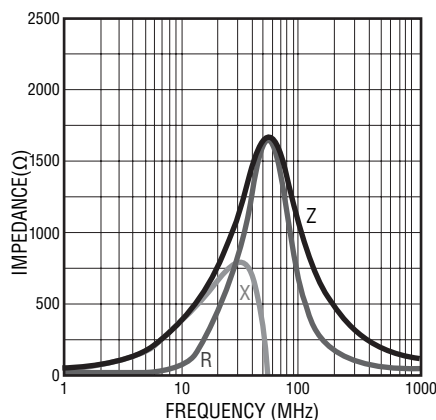

**MZ 3261- 202Y**

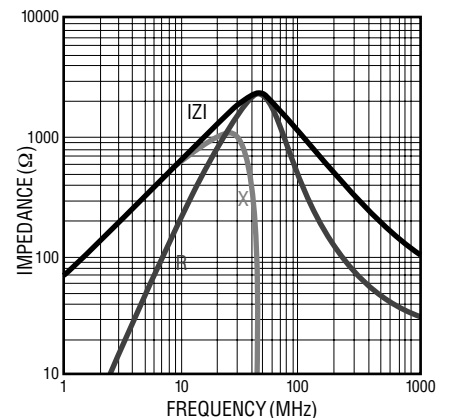

Specifications are subject to change without notice.  
Customers should verify actual device performance in their specific applications.

# MG, MU, MZ Series High Impedance Chip Ferrite Beads

**BOURNS®**

## Electrical Specifications (continued)

**MU 3261- 202Y**

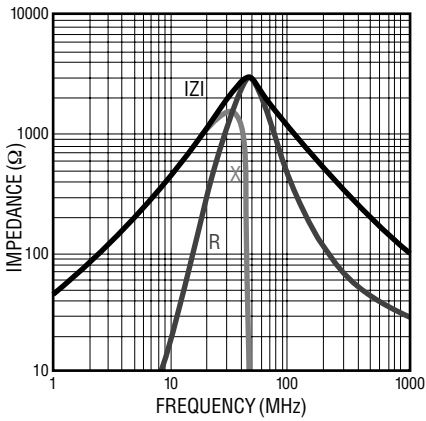

**MG 2029- 100Y**

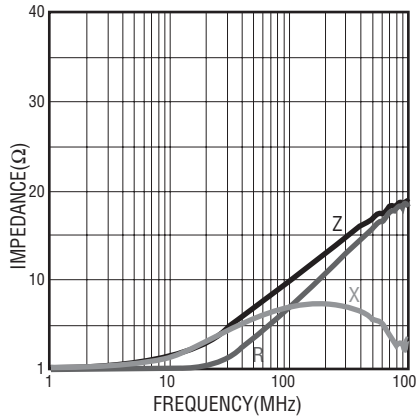

**MG 2029- 300Y**

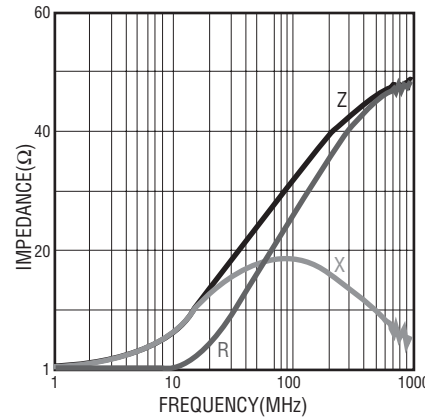

**MG 2029- 400Y**

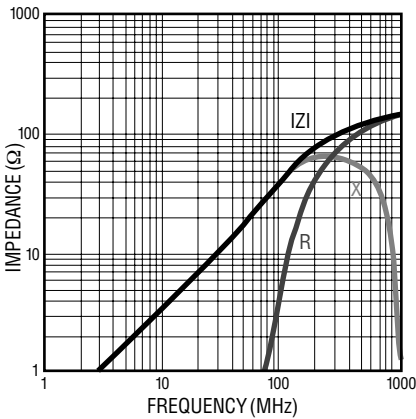

**MU 2029- 600Y**

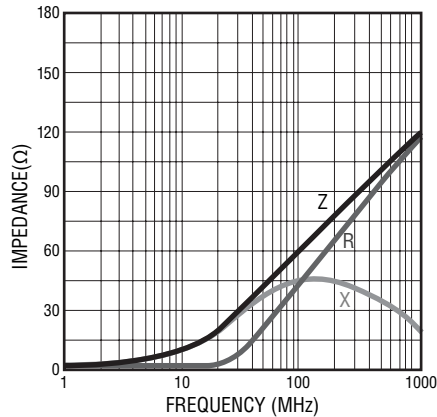

**MG 2029- 800Y**

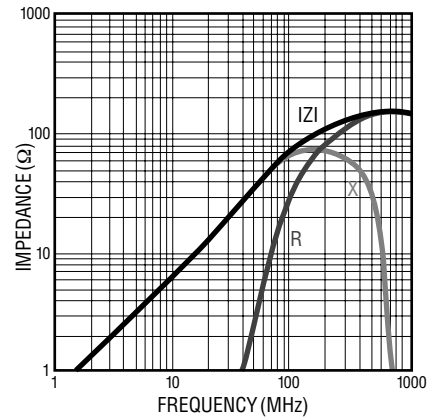

**MG 2029- 101Y**

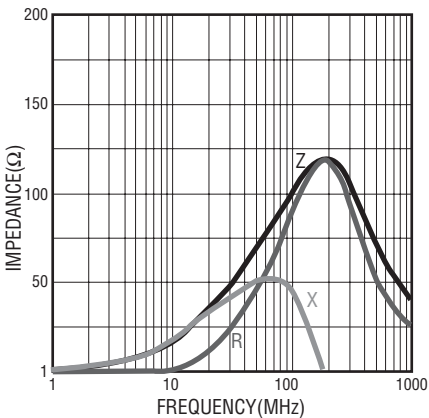

**MG 2029- 121Y**

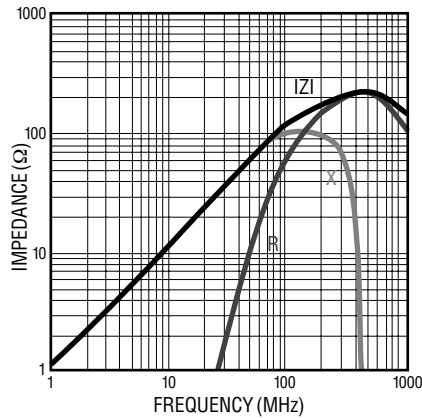

**MU 2029- 151Y**

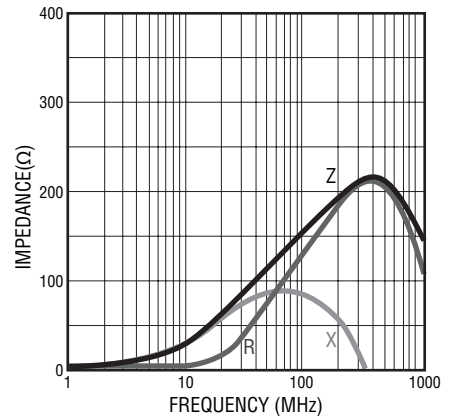

Specifications are subject to change without notice.  
Customers should verify actual device performance in their specific applications.

# MG, MU, MZ Series High Impedance Chip Ferrite Beads

**BOURNS®**

## Electrical Specifications (continued)

**MU 2029- 221Y**

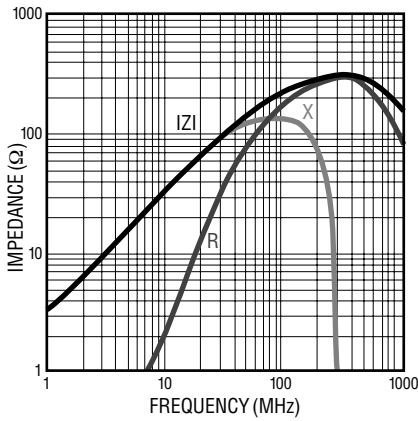

**MU 2029- 301Y**

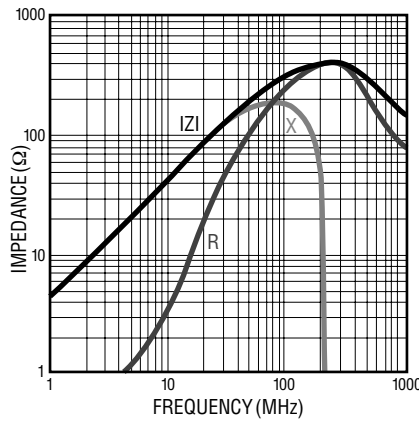

**MU 2029- 471Y**

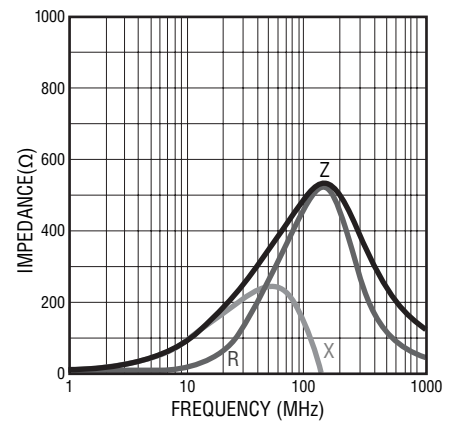

**MZ 2029- 601Y**

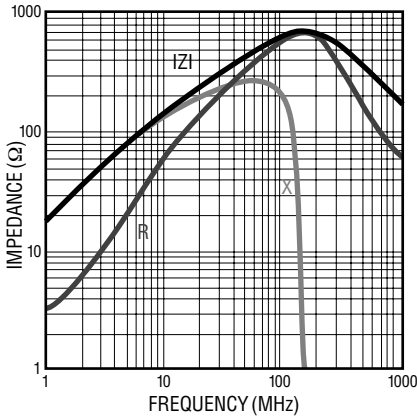

**MZ 2029- 102Y**

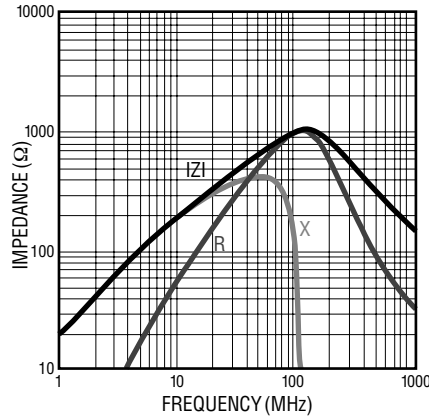

**MG 2029- 152Y**

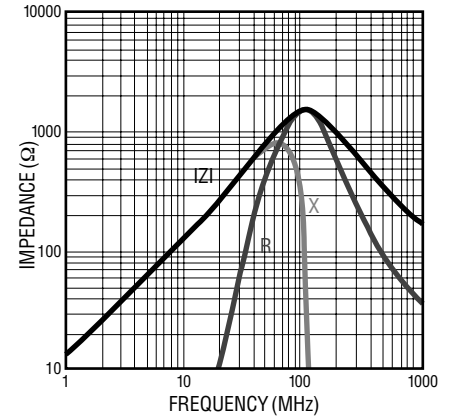

**MG 2029- 202Y**

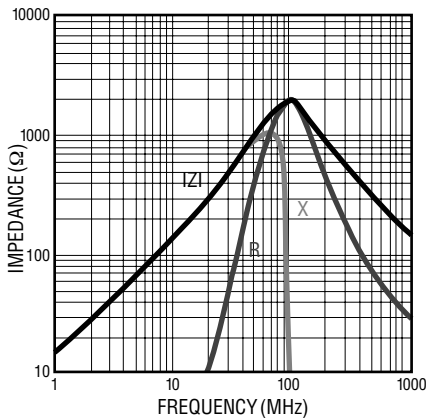

**MU 1608- 300Y**

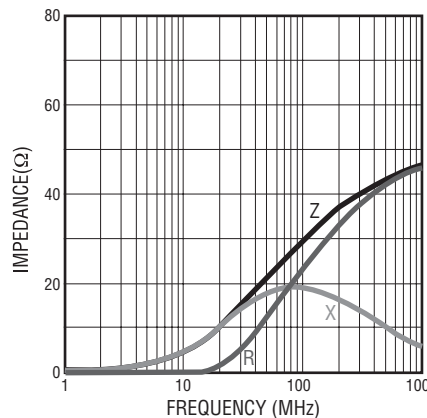

**MG 1608- 400Y**

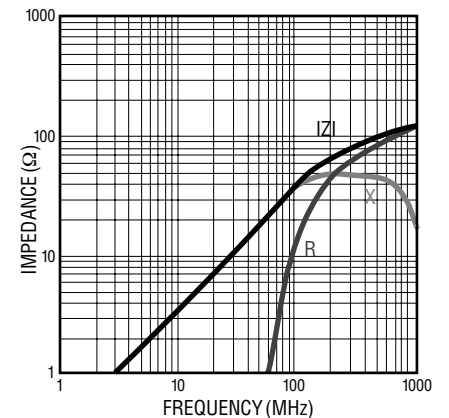

Specifications are subject to change without notice.  
Customers should verify actual device performance in their specific applications.

# MG, MU, MZ Series High Impedance Chip Ferrite Beads

**BOURNS®**

## Electrical Specifications (continued)

**MU 1608- 600Y**

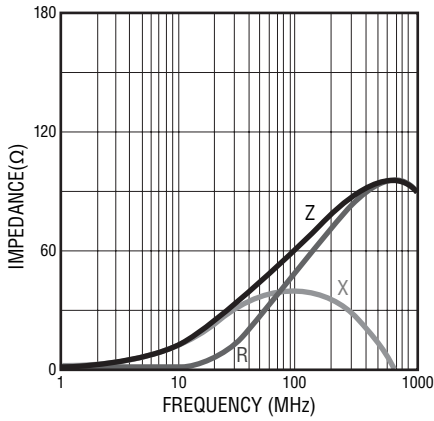

**MG 1608- 800Y**

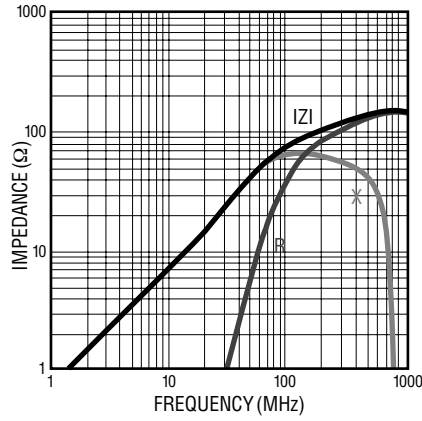

**MU 1608- 101Y**

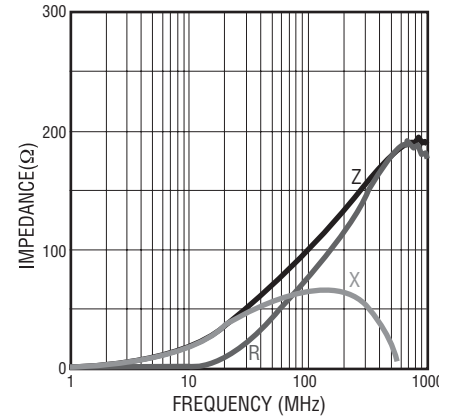

**MG 1608- 121Y**

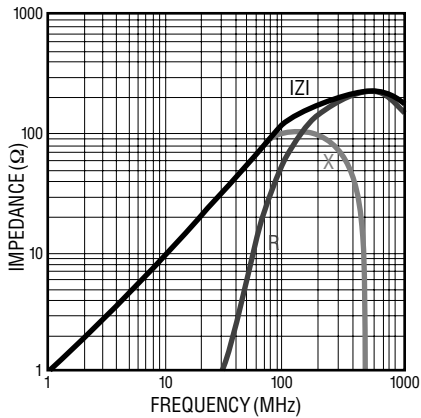

**MU 1608- 151Y**

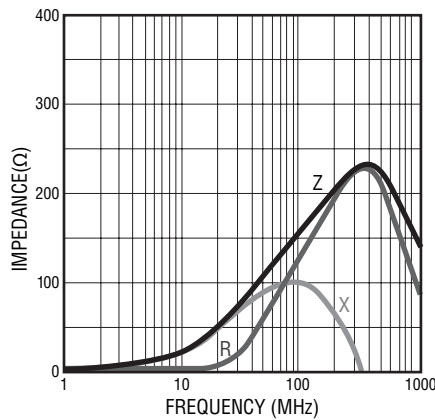

**MU 1608- 221Y**

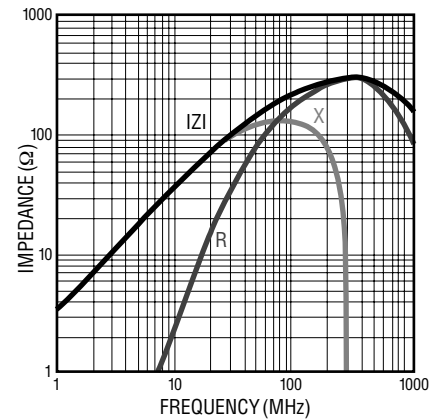

**MU 1608- 301Y**

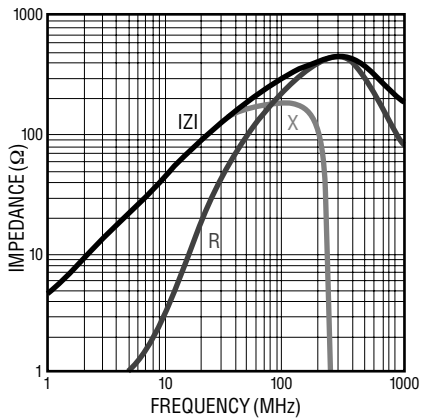

**MU 1608- 471Y**

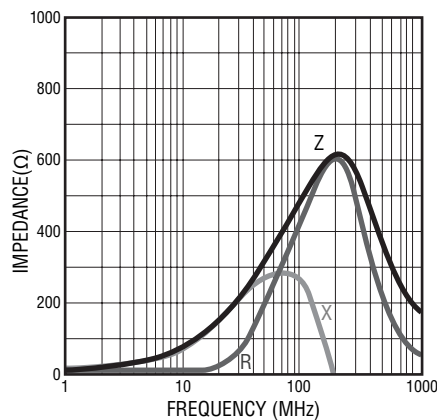

**MZ 1608- 601Y**

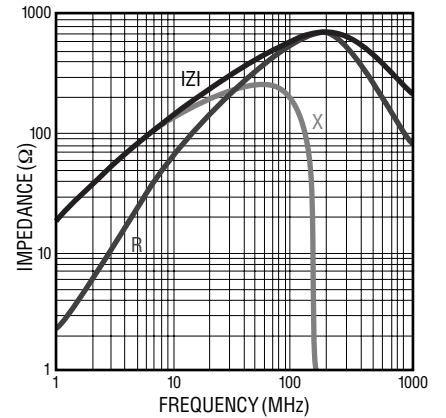

# MG, MU, MZ Series High Impedance Chip Ferrite Beads

**BOURNS®**

## Electrical Specifications (continued)

**MZ 1608- 102Y**

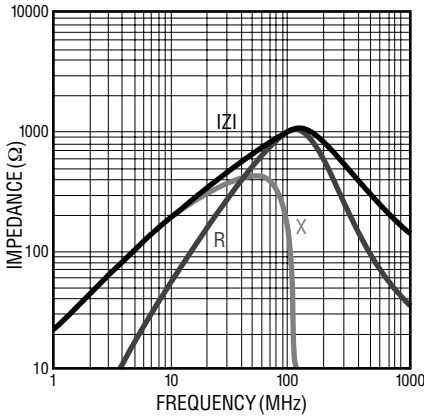

**MG 1608- 152Y**

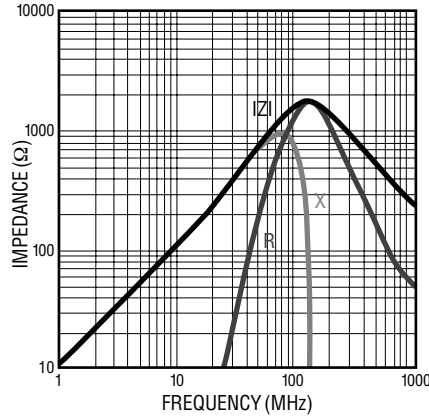

**MG 1608- 202Y**

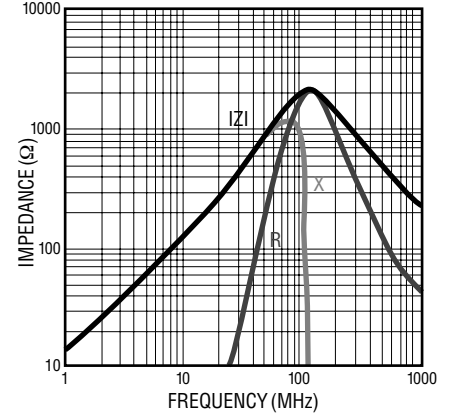

**MZ 1608- 222Y**

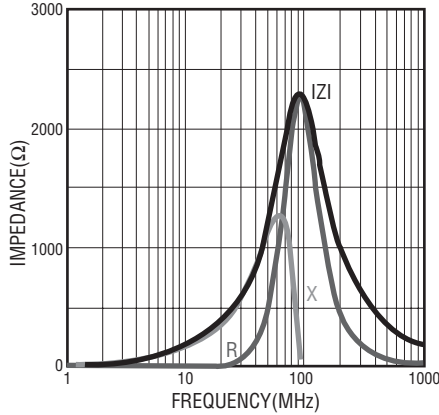

**MU 1005- 100Y**

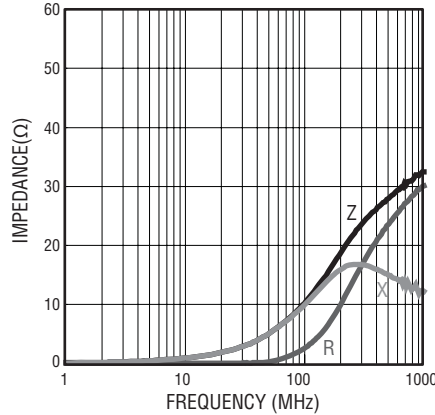

**MU 1005- 300Y**

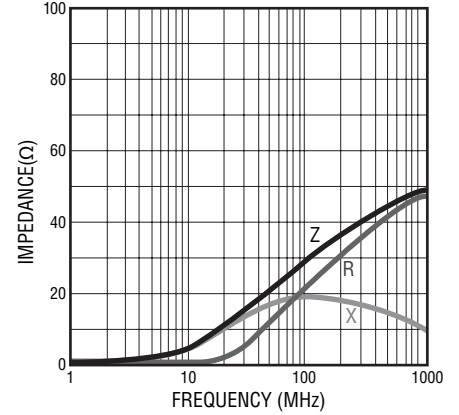

**MU 1005- 600Y**

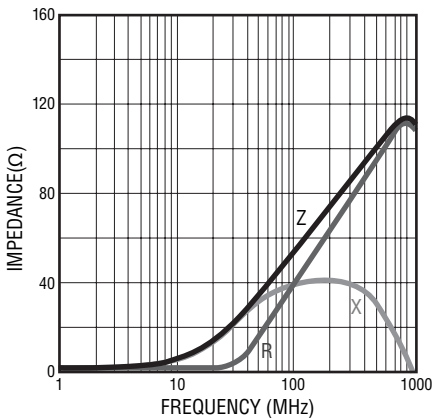

**MU 1005- 121Y**

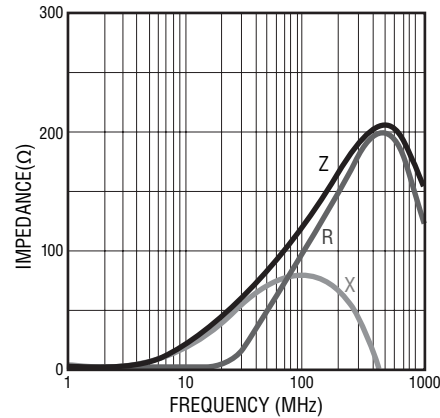

**MU 1005- 151Y**

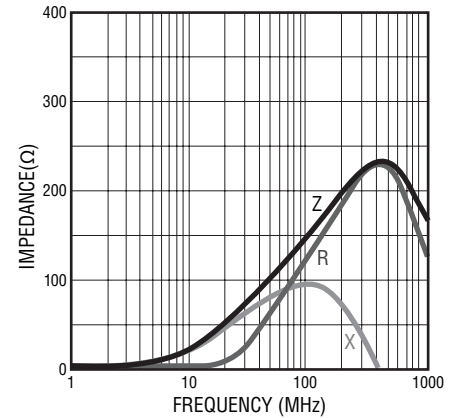

Specifications are subject to change without notice.  
Customers should verify actual device performance in their specific applications.

# MG, MU, MZ Series High Impedance Chip Ferrite Beads

**BOURNS®**

## Electrical Specifications (continued)

**MU 1005- 221Y**

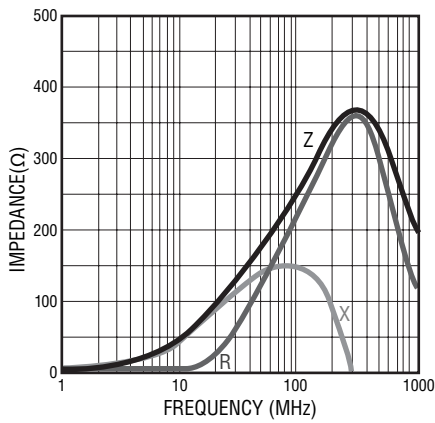

**MU 1005- 241Y**

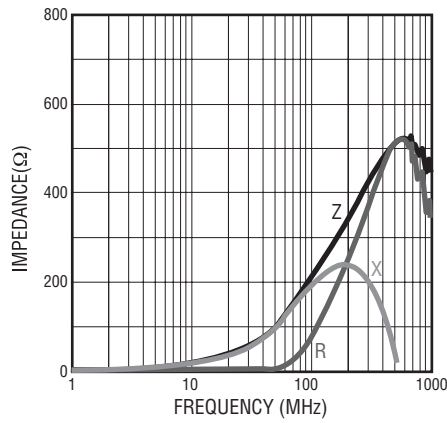

**MU 1005- 301Y**

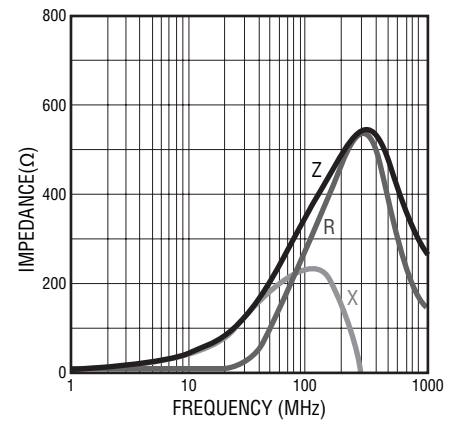

**MU 1005- 471Y**

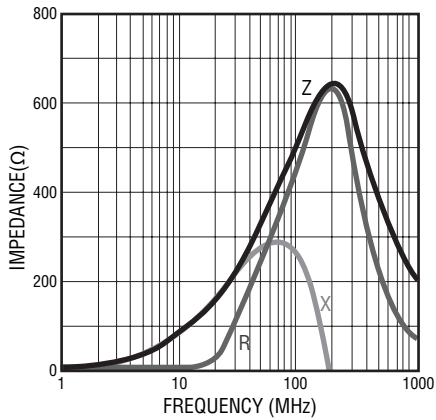

**MU 1005- 601Y**

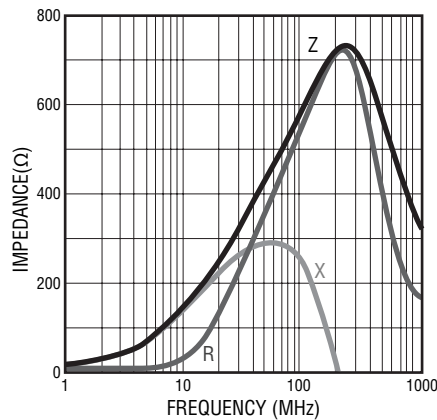

**MU 1005- 102Y**

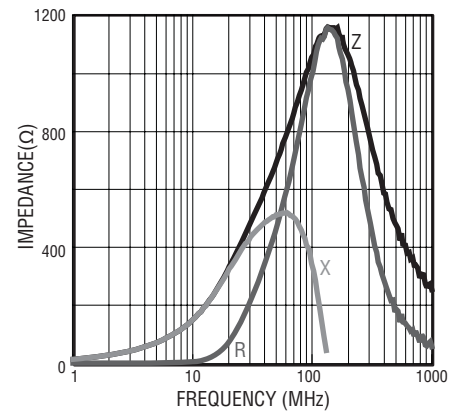

# MG, MU, MZ Series High Impedance Chip Ferrite Beads

**BOURNS®**

## Product Dimensions

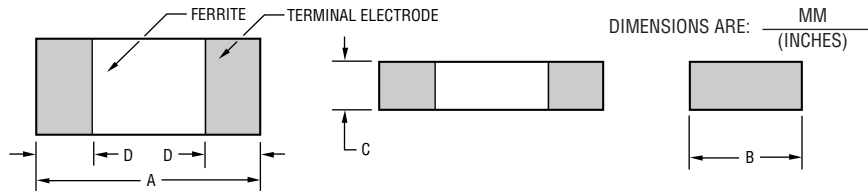

## Recommended Land Pattern

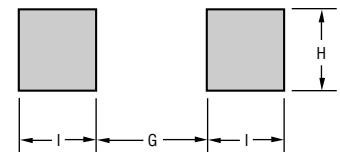

Series	A	B	C	D	G	H	I
3261	$\frac{3.2 \pm 0.2}{(.126 \pm .008)}$	$\frac{1.6 \pm 0.2}{(.063 \pm .008)}$	$\frac{1.1 \pm 0.2}{(.043 \pm .008)}$	$\frac{0.5 \pm 0.2}{(.020 \pm .008)}$	$\frac{2.0}{(.079)}$	$\frac{1.4}{(.053)}$	$\frac{1.1}{(.043)}$
2029	$\frac{2.0 \pm 0.2}{(.079 \pm .008)}$	$\frac{1.2 \pm 0.2}{(.047 \pm .008)}$	$\frac{0.9 \pm 0.2}{(.035 \pm .008)}$	$\frac{0.5 \pm 0.2}{(.020 \pm .008)}$	$\frac{1.0}{(.040)}$	$\frac{1.0}{(.040)}$	$\frac{1.0}{(.040)}$
1608	$\frac{1.6 \pm 0.2}{(.063 \pm .008)}$	$\frac{0.8 \pm 0.2}{(.031 \pm .008)}$	$\frac{0.8 \pm 0.2}{(.031 \pm .008)}$	$\frac{0.5 \pm 0.2}{(.020 \pm .008)}$	$\frac{0.7}{(.028)}$	$\frac{0.7}{(.128)}$	$\frac{0.7}{(.128)}$
1005	$\frac{1.0 \pm 0.10}{(.04 \pm .004)}$	$\frac{0.50 \pm 0.10}{(0.02 \pm .004)}$	$\frac{0.50 \pm 0.10}{(.02 \pm .004)}$	$\frac{0.25 \pm 0.10}{(.01 \pm .004)}$	$\frac{0.5}{(.02)}$	$\frac{0.55}{(.022)}$	$\frac{0.7}{(.028)}$

## Reel Dimensions

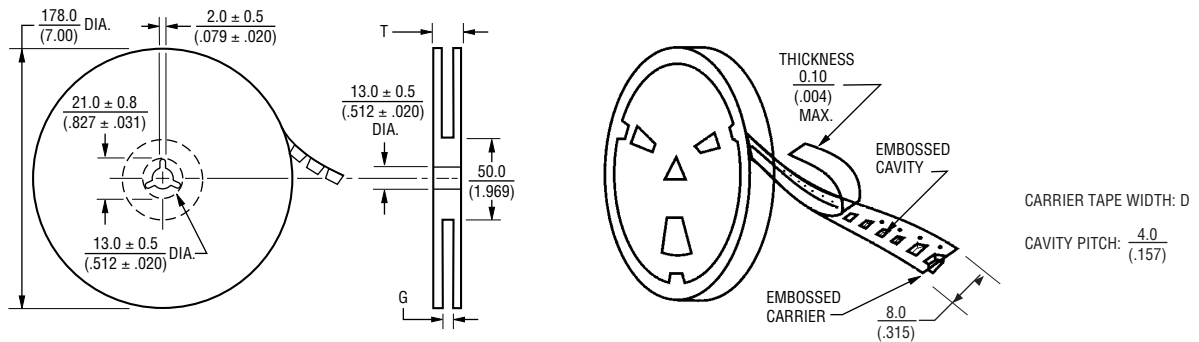

Series	Pcs. per Reel	Gross Weight (g)	D	G	T
3261	3,000	150	$\frac{8.0}{(.315)}$	$\frac{10.0 + 0}{(.394 + 0)}$	$\frac{12.5}{(.492)}$
2029	4,000	120			
1608	4,000	90			
1005	10,000	135			

## Equivalent Circuit

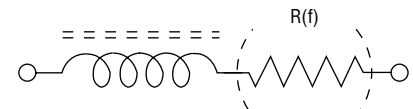

## Recommended Soldering

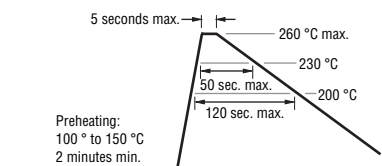

REV. 05/11

Specifications are subject to change without notice.  
Customers should verify actual device performance in their specific applications.

RoHS COMPLIANT

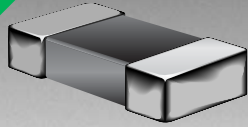

**BOURNS®**

**Features**

- High resistance to heat and humidity
- Resistance to mechanical shock and pressure
- Accurate dimensions for automatic surface mounting
- Wide impedance range



This series is currently available but is not recommended for new designs.

**MT Series Low Impedance Chip Ferrite Beads**

**Electrical Specifications**

Model Number	Impedance (Ω) at 100 MHz	RDC (Ω) Max.	IDC (mA) Max.
MT4532-250Y	25 ±25 %	0.4	300
MT4532-700Y	70 ±25 %	0.3	300
MT4532-121Y	120 ±25 %	0.3	300
MT4532-131Y	125 ±25 %	0.3	300
MT4516-800Y	80 ±25 %	0.3	300
MT4516-101Y	100 ±25 %	0.1	500
MT4516-151Y	150 ±25 %	0.3	300
MT3225-310Y	31 ±25 %	0.3	400
MT3225-520Y	52 ±25 %	0.3	400
MT3225-600Y	60 ±25 %	0.3	400
MT3266-600Y	60 ±25 %	0.3	400
MT3261-190Y	19 ±25 %	0.2	500
MT3261-260Y	26 ±25 %	0.2	500
MT3261-310Y	31 ±25 %	0.2	500
MT3261-420Y	42 ±25 %	0.2	500
MT3261-500Y	50 ±25 %	0.2	500
MT3261-700Y	70 ±25 %	0.2	500
MT3261-900Y	90 ±25 %	0.2	500
MT2029-070Y	7 ±25 %	0.2	600
MT2029-100Y	10 ±25 %	0.2	600
MT2029-110Y	11 ±25 %	0.2	600
MT2029-170Y	17 ±25 %	0.1	600
MT2029-260Y	26 ±25 %	0.1	600
MT2029-300Y	30 ±25 %	0.1	600
MT2029-400Y	40 ±25 %	0.1	600
MT1608-050Y	5 ±25 %	0.2	600
MT1608-090Y	9 ±25 %	0.2	500
MT1608-300Y	30 ±25 %	0.3	400

**General Specifications**

Operating Temperature .....-55 °C to +125 °C  
 Storage Temperature...-55 °C to +125 °C  
 Storage Condition .....+40 °C max. at 70 % RH  
 Reflow Soldering .....230 °C, 50 seconds max.  
 Resistance to Soldering Heat .....260 °C, 5 seconds  
 Rated Current .....Based on max. temperature rise of +40 °C  
 Terminal Strength (Force "F" applied for 30 seconds)  
 4532 Series .....1.5 F (Kg)  
 4516 Series .....1.0 F (Kg)  
 3225 Series .....1.0 F (Kg)  
 3266 Series .....1.0 F (Kg)  
 3261 Series .....1.0 F (Kg)  
 2029 Series .....0.6 F (Kg)  
 1608 Series .....0.5 F (Kg)

**Materials**

Core Material .....Ferrite  
 Internal Conductor .....Ag or Ag/Pd  
 Terminal .....Ag/Ni/Sn

**Electrical Specifications (continued)**

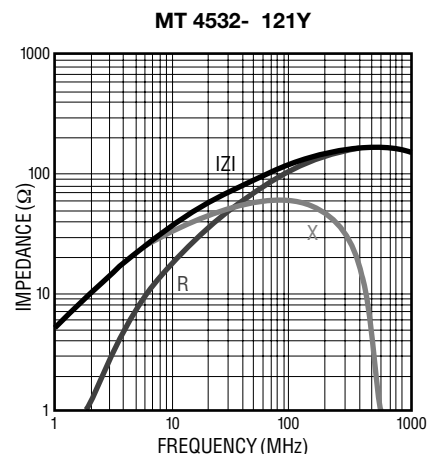
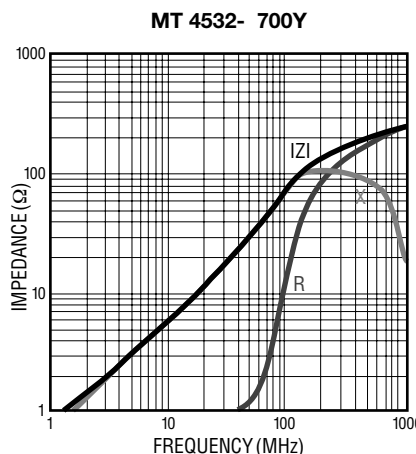
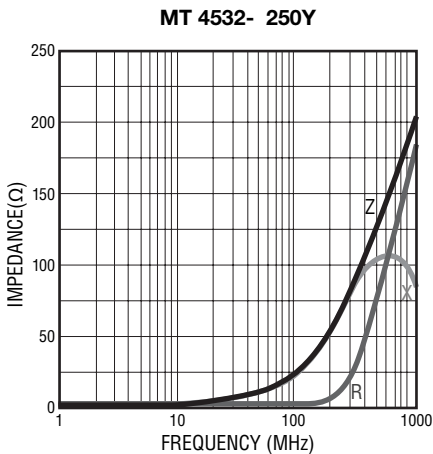

\*RoHS Directive 2002/95/EC Jan 27, 2003 including Annex. Specifications are subject to change without notice. Customers should verify actual device performance in their specific applications.

## Applications

- Power supply lines
- IC power lines
- Signal lines

# MT Series Low Impedance Chip Ferrite Beads

## Electrical Specifications (continued)

**MT 4532- 131Y**

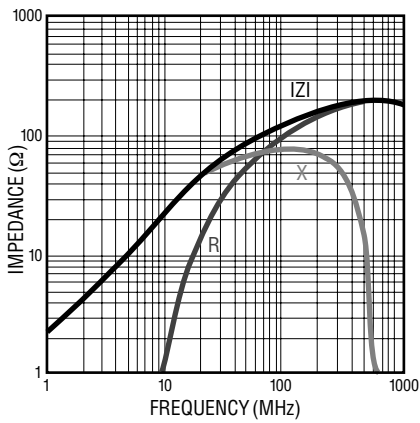

**MT 4516- 800Y**

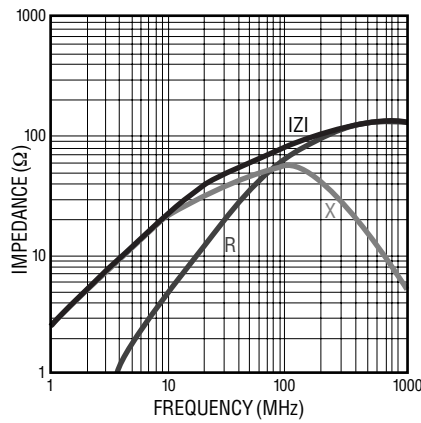

**MT 4516- 101Y**

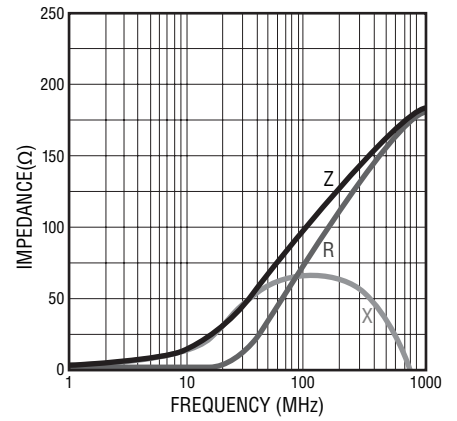

**MT 4516- 151Y**

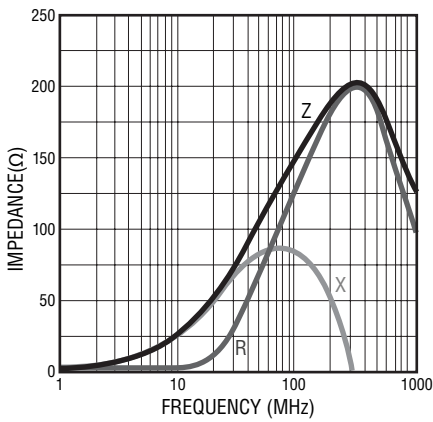

**MT 3225- 310Y**

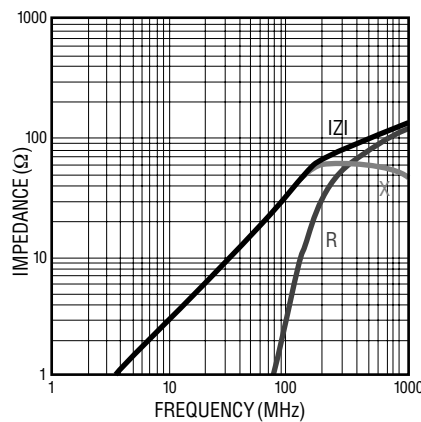

**MT 3225- 520Y**

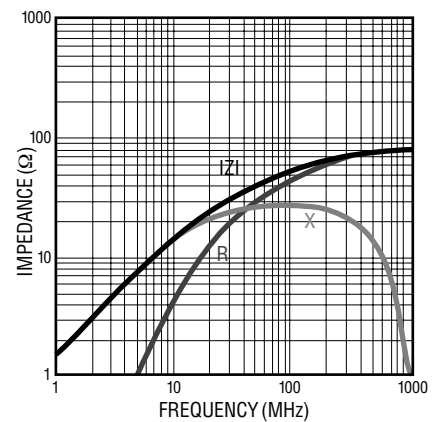

**MT 3225- 600Y**

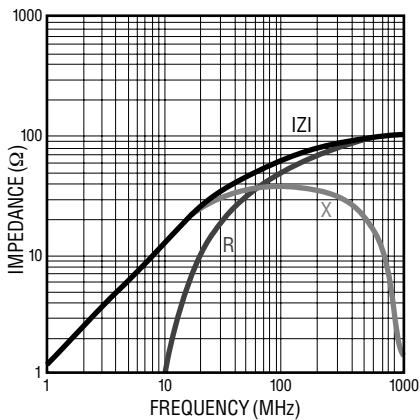

**MT 3266- 600Y**

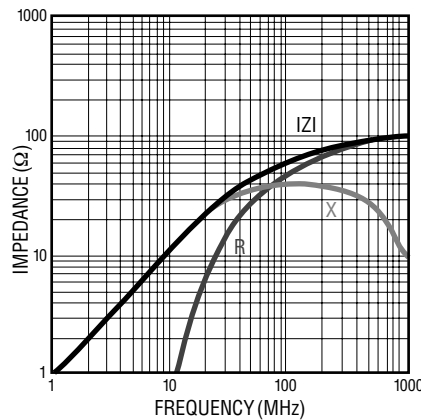

**MT 3261- 190Y**

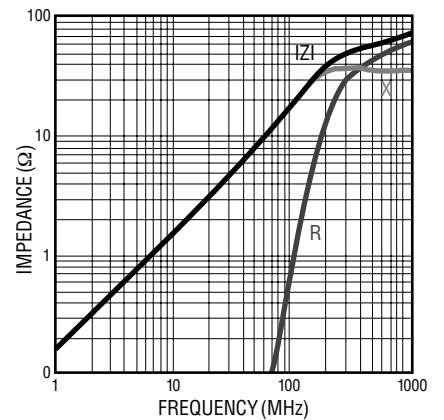

Specifications are subject to change without notice.  
Customers should verify actual device performance in their specific applications.

# MT Series Low Impedance Chip Ferrite Beads

## Electrical Specifications (continued)

**MT 3261- 260Y**

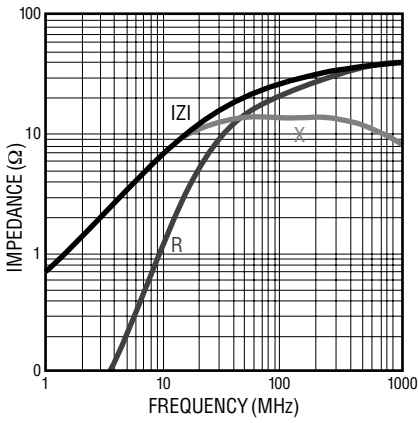

**MT 3261- 310Y**

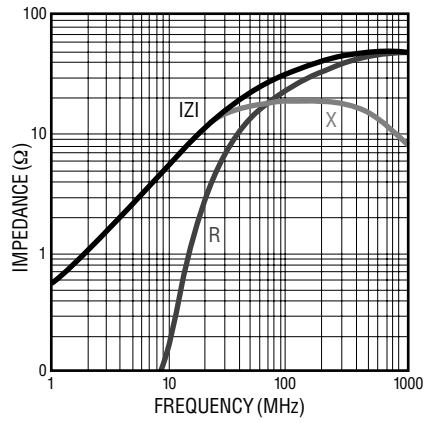

**MT 3261- 420Y**

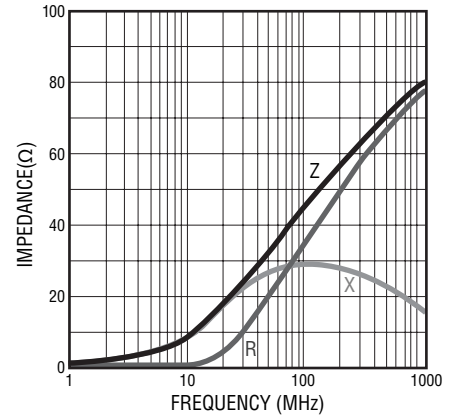

**MT 3261- 500Y**

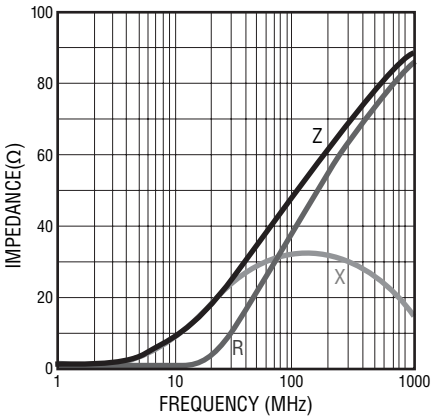

**MT 3261- 700Y**

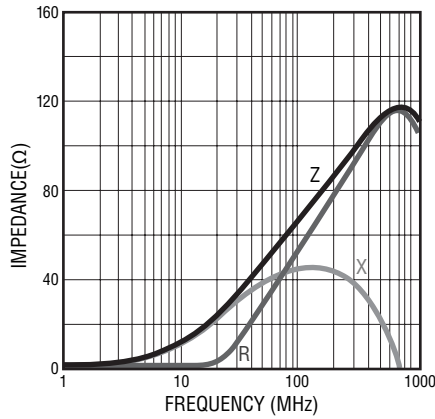

**MT 3261- 900Y**

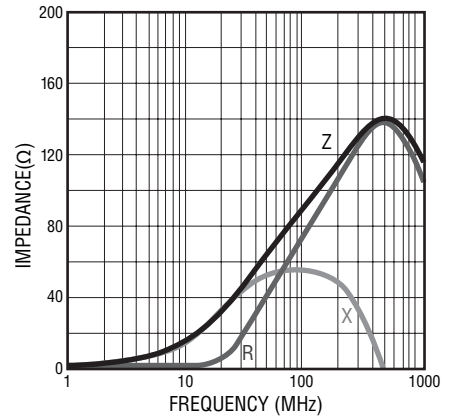

**MT 2029- 070Y**

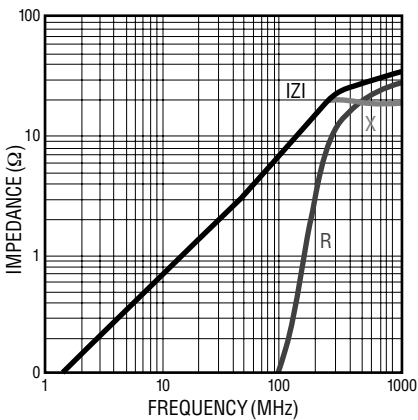

**MT 2029- 100Y**

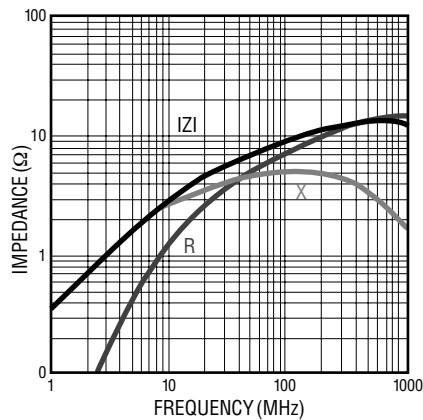

**MT 2029- 110Y**

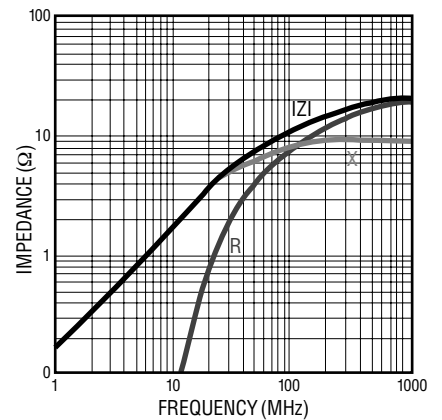

Specifications are subject to change without notice. Customers should verify actual device performance in their specific applications.

# MT Series Low Impedance Chip Ferrite Beads

## Electrical Specifications (continued)

MT 2029- 170Y

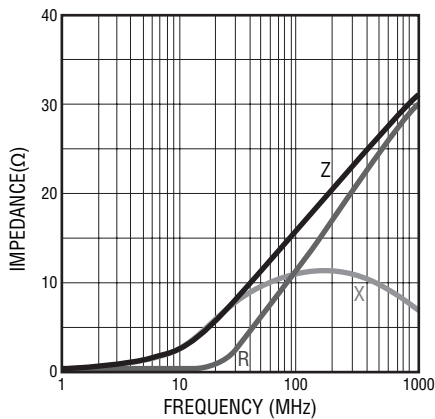

MT 2029- 260Y

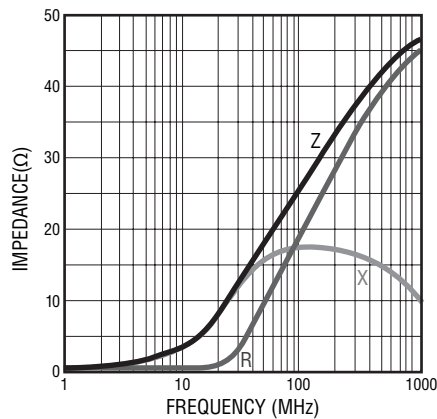

MT 2029- 300Y

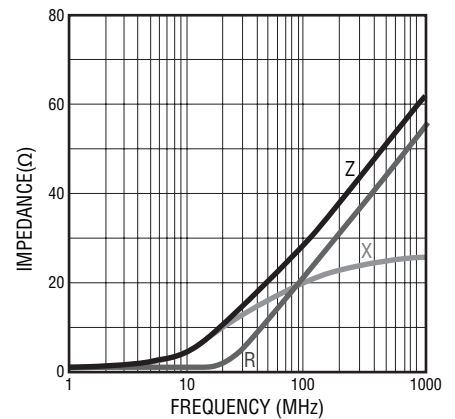

MT 2029- 400Y

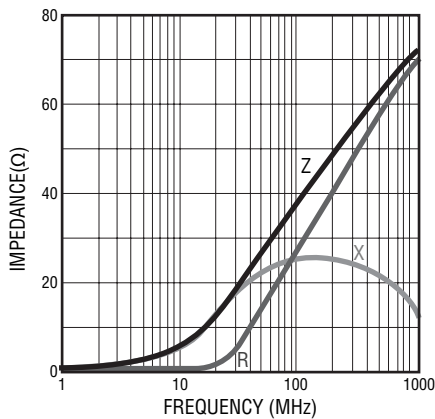

MT 1608- 050Y

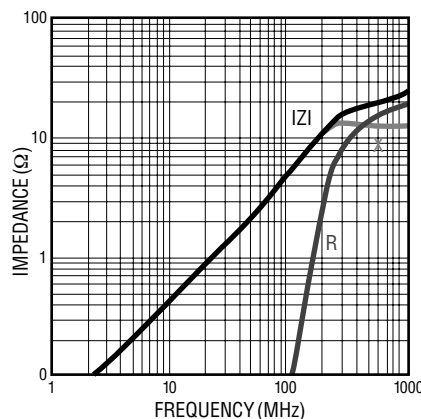

MT 1608- 090Y

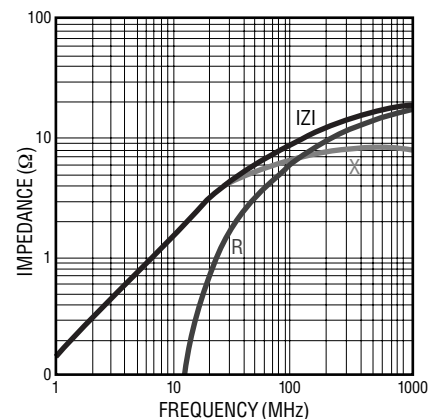

MT 1608- 300Y

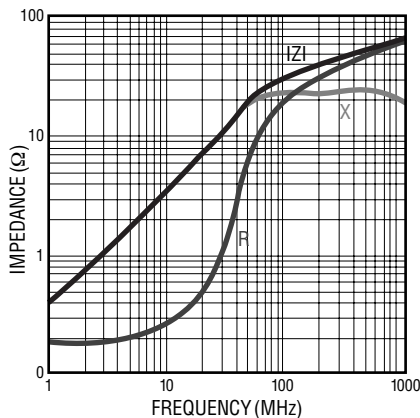

## Equivalent Circuit

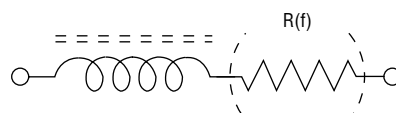

## Recommended Soldering

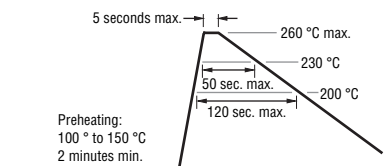

Specifications are subject to change without notice.  
Customers should verify actual device performance in their specific applications.

# MT Series Low Impedance Chip Ferrite Beads

## Product Dimensions

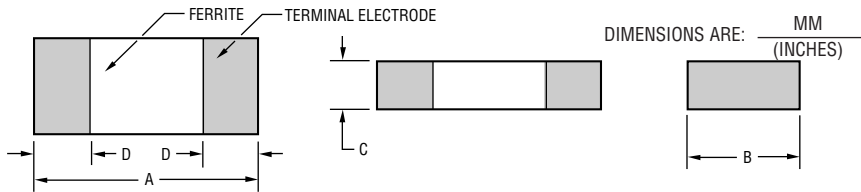

## Recommended Land Pattern

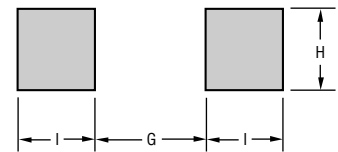

Series	A	B	C	D	G	H	I
4532	$\frac{4.5 \pm 0.2}{(.177 \pm .008)}$	$\frac{3.2 \pm 0.2}{(.126 \pm .008)}$	$\frac{1.5 \pm 0.2}{(.059 \pm .008)}$	$\frac{0.5 \pm 0.2}{(.020 \pm .008)}$	$\frac{3.0}{(.118)}$	$\frac{3.0}{(.118)}$	$\frac{1.5}{(.059)}$
4516	$\frac{4.5 \pm 0.2}{(.177 \pm .008)}$	$\frac{1.6 \pm 0.2}{(.063 \pm .008)}$	$\frac{1.6 \pm 0.2}{(.063 \pm .008)}$	$\frac{0.5 \pm 0.2}{(.020 \pm .008)}$	$\frac{3.0}{(.118)}$	$\frac{1.4}{(.055)}$	$\frac{1.5}{(.059)}$
3266	$\frac{3.2 \pm 0.2}{(.126 \pm .008)}$	$\frac{1.6 \pm 0.2}{(.063 \pm .008)}$	$\frac{1.6 \pm 0.2}{(.063 \pm .008)}$	$\frac{0.5 \pm 0.2}{(.020 \pm .008)}$	$\frac{2.2}{(.118)}$	$\frac{1.4}{(.053)}$	$\frac{1.1}{(.043)}$
3261	$\frac{3.2 \pm 0.2}{(.126 \pm .008)}$	$\frac{1.6 \pm 0.2}{(.063 \pm .008)}$	$\frac{1.1 \pm 0.2}{(.043 \pm .008)}$	$\frac{0.5 \pm 0.2}{(.020 \pm .008)}$	$\frac{2.0}{(.079)}$	$\frac{1.4}{(.053)}$	$\frac{1.1}{(.043)}$
3225	$\frac{3.2 \pm 0.2}{(.126 \pm .008)}$	$\frac{2.5 \pm 0.2}{(.098 \pm .008)}$	$\frac{1.3 \pm 0.2}{(.051 \pm .008)}$	$\frac{0.5 \pm 0.2}{(.020 \pm .008)}$	$\frac{2.2}{(.118)}$	$\frac{2.3}{(.091)}$	$\frac{1.1}{(.043)}$
2029	$\frac{2.0 \pm 0.2}{(.079 \pm .008)}$	$\frac{1.2 \pm 0.2}{(.047 \pm .008)}$	$\frac{0.9 \pm 0.2}{(.035 \pm .008)}$	$\frac{0.5 \pm 0.2}{(.020 \pm .008)}$	$\frac{1.0}{(.040)}$	$\frac{1.0}{(.040)}$	$\frac{1.0}{(.040)}$
1608	$\frac{1.6 \pm 0.2}{(.063 \pm .008)}$	$\frac{0.8 \pm 0.2}{(.031 \pm .008)}$	$\frac{0.8 \pm 0.2}{(.031 \pm .008)}$	$\frac{0.5 \pm 0.2}{(.020 \pm .008)}$	$\frac{0.7}{(.028)}$	$\frac{0.7}{(.128)}$	$\frac{0.7}{(.128)}$

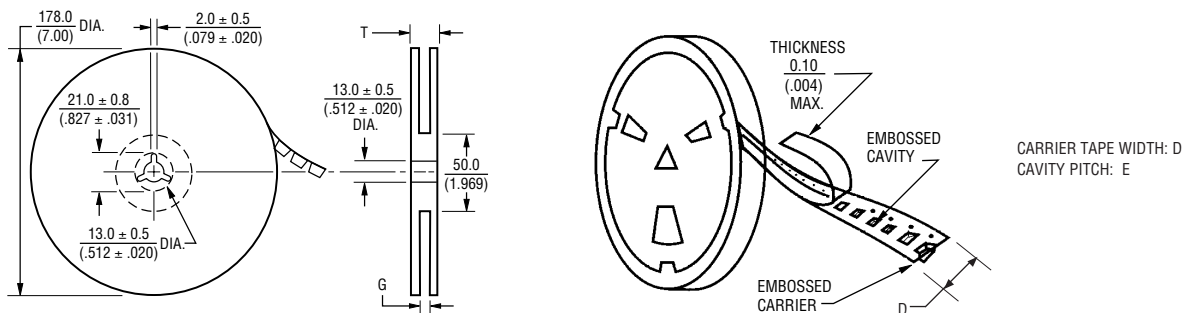

## Reel Dimensions







Series	Pcs. per Reel	Gross Weight (g)	D	E	G	T
4532	1,000	170	$\frac{12.0}{(.472)}$	$\frac{8.0}{(.315)}$	$\frac{14.0 + 0}{(.551 + 0)}$	$\frac{16.5}{(.650)}$
4516	2,000	180	$\frac{12.0}{(.472)}$	$\frac{8.0}{(.315)}$	$\frac{14.0 + 0}{(.551 + 0)}$	$\frac{16.5}{(.650)}$
3266	2,000	140	$\frac{8.0}{(.315)}$	$\frac{4.0}{(.157)}$	$\frac{10.0 + 0}{(.394 + 0)}$	$\frac{12.5}{(.492)}$
3261	3,000	150	$\frac{8.0}{(.315)}$	$\frac{4.0}{(.157)}$	$\frac{10.0 + 0}{(.394 + 0)}$	$\frac{12.5}{(.492)}$
3225	2,500	160	$\frac{8.0}{(.315)}$	$\frac{4.0}{(.157)}$	$\frac{10.0 + 0}{(.394 + 0)}$	$\frac{12.5}{(.492)}$
2029	4,000	120	$\frac{8.0}{(.315)}$	$\frac{4.0}{(.157)}$	$\frac{10.0 + 0}{(.394 + 0)}$	$\frac{12.5}{(.492)}$
1608	4,000	90	$\frac{8.0}{(.315)}$	$\frac{4.0}{(.157)}$	$\frac{10.0 + 0}{(.394 + 0)}$	$\frac{12.5}{(.492)}$

## Looking for pricing, stock, or lifecycle information?

Click below to explore more details on WIN SOURCE:

-  [View MH3261-121Y on WIN SOURCE](#)
-  [Bourns Inc. Information](#)

## Optimize Your Supply Chain with WIN SOURCE Solutions

-  Global Sourcing Solution
-  Obsolete Management
-  Cost Control Management
-  Shortage Management
-  Alternative Solution
-  Excess Inventory Management