



THE DATASHEET OF MBRF2545CT



Switch-mode Schottky Power Rectifier

MBRF2545CTG

The Switch-mode Power Rectifier employs the Schottky Barrier principle in a large area metal-to-silicon power diode. State-of-the-art geometry features epitaxial construction with oxide passivation and metal overlay contact. Ideally suited for use as rectifiers in very low-voltage, high-frequency switching power supplies, free wheeling diodes and polarity protection diodes.

Features

- Highly Stable Oxide Passivated Junction
- Very Low Forward Voltage Drop
- Matched Dual Die Construction
- High Junction Temperature Capability
- High dv/dt Capability
- Excellent Ability to Withstand Reverse Avalanche Energy Transients
- Guardring for Stress Protection
- Epoxy Meets UL 94 V-0 @ 0.125 in
- Electrically Isolated
- No Isolation Hardware Required
- These Devices are Pb-Free and are RoHS Compliant

Mechanical Characteristics:

- Case: Epoxy, Molded
- Weight: 1.9 Grams (Approximately)
- Finish: All External Surfaces Corrosion Resistant and Terminal Leads are Readily Solderable
- Lead Temperature for Soldering Purposes: 260°C Max. for 10 Seconds



ON Semiconductor®

www.onsemi.com

SCHOTTKY BARRIER RECTIFIER 25 AMPERES, 45 VOLTS

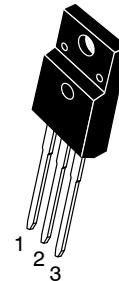
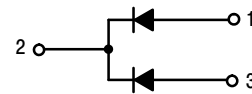

TO-220 FULLPAK™
CASE 221D

MARKING DIAGRAM

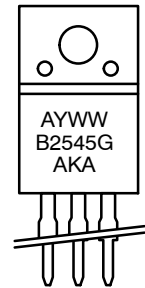

A = Assembly Location
Y = Year
WW = Work Week
B2545 = Device Code
G = Pb-Free Package
AKA = Diode Polarity

ORDERING INFORMATION

Device	Package	Shipping
MBRF2545CTG	TO-220 (Pb-Free)	50 Units/Rail

MBRF2545CTG

MAXIMUM RATINGS (Per Leg)

Rating	Symbol	Value	Unit
Peak Repetitive Reverse Voltage Working Peak Reverse Voltage DC Blocking Voltage	V_{RRM} V_{RWM} V_R	45	V
Average Rectified Forward Current (Rated V_R), $T_C = 125^\circ\text{C}$	$I_{F(AV)}$	12.5 25	A
Peak Repetitive Forward Current (Rated V_R , Square Wave, 20 kHz), $T_C = 125^\circ\text{C}$	I_{FRM}	25	A
Non-repetitive Peak Surge Current (Surge applied at rated load conditions halfwave, single phase, 60 Hz)	I_{FSM}	150	A
Peak Repetitive Reverse Surge Current (2.0 μs , 1.0 kHz)	I_{RRM}	1.0	A
Operating Junction and Storage Temperature (Note 1)	T_J, T_{stg}	- 65 to +175	$^\circ\text{C}$
Voltage Rate of Change (Rated V_R)	dv/dt	10000	V/ μs
RMS Isolation Voltage (t = 0.3 second, R.H. \leq 30%, $T_A = 25^\circ\text{C}$) (Note 2)	V_{iso1}	4500	V

THERMAL CHARACTERISTICS (Per Leg)

Maximum Thermal Resistance, Junction-to-Case	$R_{\theta JC}$	3.5	$^\circ\text{C}/\text{W}$
Maximum Lead Temperature for Soldering Purposes: 1/8" from Case for 5 Seconds	T_L	260	$^\circ\text{C}$

ELECTRICAL CHARACTERISTICS (Per Leg)

Characteristic	Symbol	Max	Unit
Maximum Instantaneous Forward Voltage (Note 3) ($i_F = 12.5$ A, $T_C = 25^\circ\text{C}$) ($i_F = 12.5$ A, $T_C = 125^\circ\text{C}$)	v_F	0.7 0.62	V
Maximum Instantaneous Reverse Current (Note 3) (Rated DC Voltage, $T_C = 25^\circ\text{C}$) (Rated DC Voltage, $T_C = 125^\circ\text{C}$)	i_R	0.2 40	mA

Stresses exceeding those listed in the Maximum Ratings table may damage the device. If any of these limits are exceeded, device functionality should not be assumed, damage may occur and reliability may be affected.

- The heat generated must be less than the thermal conductivity from Junction-to-Ambient: $dP_D/dT_J < 1/R_{\theta JA}$.
- Proper strike and creepage distance must be provided.
- Pulse Test: Pulse Width = 300 μs , Duty Cycle \leq 2.0%.

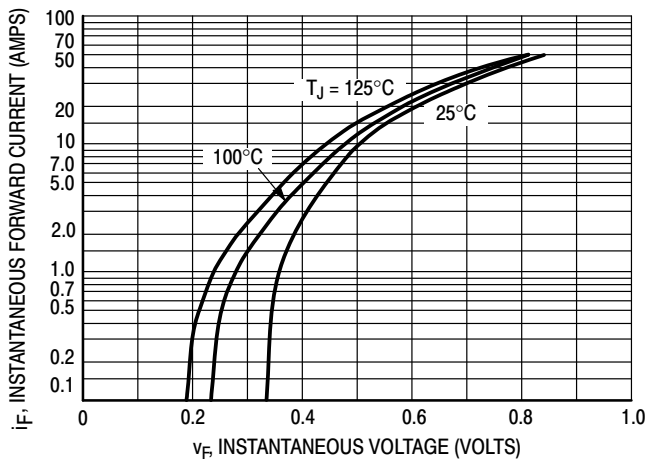

Figure 1. Typical Forward Voltage, Per Leg

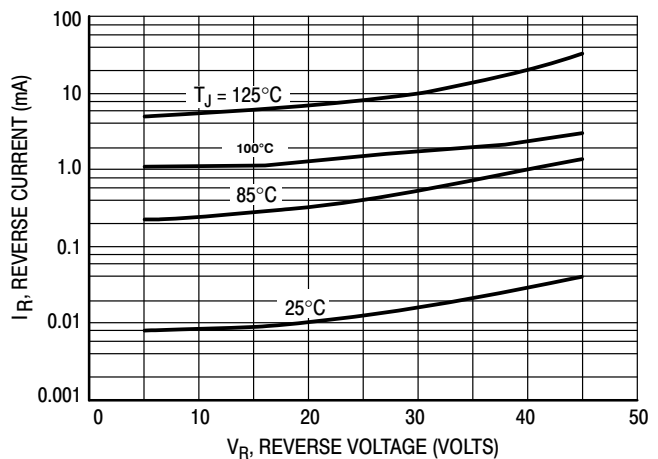

Figure 2. Typical Reverse Current, Per Leg

MBRF2545CTG

TEST CONDITIONS FOR ISOLATION TEST*

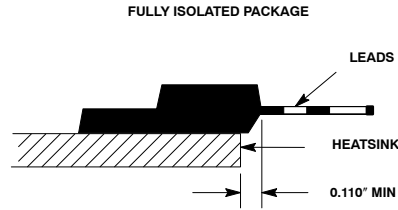
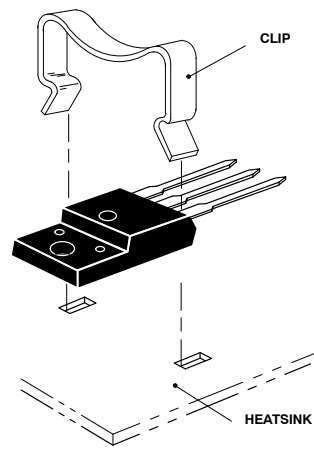

Figure 3. Mounting Position

* Measurement made between leads and heatsink with all leads shorted together.

MOUNTING INFORMATION



Clip-Mounted

Figure 4. Typical Mounting Technique

MECHANICAL CASE OUTLINE PACKAGE DIMENSIONS

ON Semiconductor®

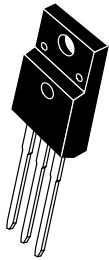

SCALE 1:1

TO-220 FULLPAK CASE 221D-03 ISSUE K

DATE 27 FEB 2009

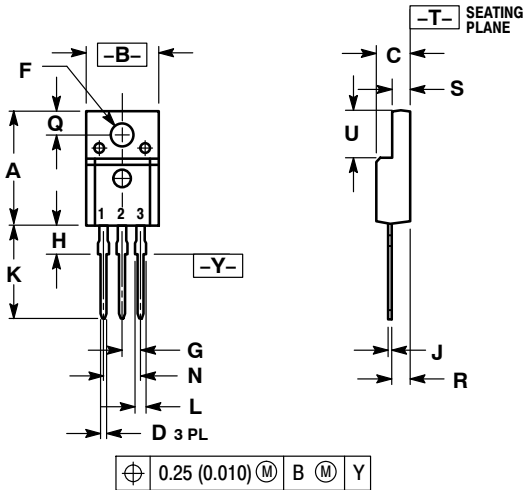

- NOTES:
1. DIMENSIONING AND TOLERANCING PER ANSI Y14.5M, 1982.
 2. CONTROLLING DIMENSION: INCH
 3. 221D-01 THRU 221D-02 OBSOLETE, NEW STANDARD 221D-03.

DIM	INCHES		MILLIMETERS	
	MIN	MAX	MIN	MAX
A	0.617	0.635	15.67	16.12
B	0.392	0.419	9.96	10.63
C	0.177	0.193	4.50	4.90
D	0.024	0.039	0.60	1.00
F	0.116	0.129	2.95	3.28
G	0.100 BSC		2.54 BSC	
H	0.118	0.135	3.00	3.43
J	0.018	0.025	0.45	0.63
K	0.503	0.541	12.78	13.73
L	0.048	0.058	1.23	1.47
N	0.200 BSC		5.08 BSC	
Q	0.122	0.138	3.10	3.50
R	0.099	0.117	2.51	2.96
S	0.092	0.113	2.34	2.87
U	0.239	0.271	6.06	6.88

MARKING DIAGRAMS

- | | | |
|--|---|--|
| STYLE 1:
PIN 1. GATE
2. DRAIN
3. SOURCE | STYLE 2:
PIN 1. BASE
2. COLLECTOR
3. EMITTER | STYLE 3:
PIN 1. ANODE
2. CATHODE
3. ANODE |
| STYLE 4:
PIN 1. CATHODE
2. ANODE
3. CATHODE | STYLE 5:
PIN 1. CATHODE
2. ANODE
3. GATE | STYLE 6:
PIN 1. MT 1
2. MT 2
3. GATE |



Bipolar

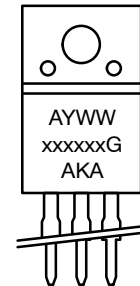

Rectifier

- | | |
|-------------------------------|---------------------------|
| xxxxxx = Specific Device Code | A = Assembly Location |
| G = Pb-Free Package | Y = Year |
| A = Assembly Location | WW = Work Week |
| Y = Year | xxxxxx = Device Code |
| WW = Work Week | G = Pb-Free Package |
| | AKA = Polarity Designator |

DOCUMENT NUMBER:	98ASB42514B	Electronic versions are uncontrolled except when accessed directly from the Document Repository. Printed versions are uncontrolled except when stamped "CONTROLLED COPY" in red.
DESCRIPTION:	TO-220 FULLPAK	PAGE 1 OF 1

ON Semiconductor and are trademarks of Semiconductor Components Industries, LLC dba ON Semiconductor or its subsidiaries in the United States and/or other countries. ON Semiconductor reserves the right to make changes without further notice to any products herein. ON Semiconductor makes no warranty, representation or guarantee regarding the suitability of its products for any particular purpose, nor does ON Semiconductor assume any liability arising out of the application or use of any product or circuit, and specifically disclaims any and all liability, including without limitation special, consequential or incidental damages. ON Semiconductor does not convey any license under its patent rights nor the rights of others.

onsemi, **Onsemi**, and other names, marks, and brands are registered and/or common law trademarks of Semiconductor Components Industries, LLC dba "**onsemi**" or its affiliates and/or subsidiaries in the United States and/or other countries. **onsemi** owns the rights to a number of patents, trademarks, copyrights, trade secrets, and other intellectual property. A listing of **onsemi**'s product/patent coverage may be accessed at www.onsemi.com/site/pdf/Patent-Marking.pdf. **onsemi** reserves the right to make changes at any time to any products or information herein, without notice. The information herein is provided "as-is" and **onsemi** makes no warranty, representation or guarantee regarding the accuracy of the information, product features, availability, functionality, or suitability of its products for any particular purpose, nor does **onsemi** assume any liability arising out of the application or use of any product or circuit, and specifically disclaims any and all liability, including without limitation special, consequential or incidental damages. Buyer is responsible for its products and applications using **onsemi** products, including compliance with all laws, regulations and safety requirements or standards, regardless of any support or applications information provided by **onsemi**. "Typical" parameters which may be provided in **onsemi** data sheets and/or specifications can and do vary in different applications and actual performance may vary over time. All operating parameters, including "Typicals" must be validated for each customer application by customer's technical experts. **onsemi** does not convey any license under any of its intellectual property rights nor the rights of others. **onsemi** products are not designed, intended, or authorized for use as a critical component in life support systems or any FDA Class 3 medical devices or medical devices with a same or similar classification in a foreign jurisdiction or any devices intended for implantation in the human body. Should Buyer purchase or use **onsemi** products for any such unintended or unauthorized application, Buyer shall indemnify and hold **onsemi** and its officers, employees, subsidiaries, affiliates, and distributors harmless against all claims, costs, damages, and expenses, and reasonable attorney fees arising out of, directly or indirectly, any claim of personal injury or death associated with such unintended or unauthorized use, even if such claim alleges that **onsemi** was negligent regarding the design or manufacture of the part. **onsemi** is an Equal Opportunity/Affirmative Action Employer. This literature is subject to all applicable copyright laws and is not for resale in any manner.

ADDITIONAL INFORMATION

TECHNICAL PUBLICATIONS:

Technical Library: www.onsemi.com/design/resources/technical-documentation
onsemi Website: www.onsemi.com

ONLINE SUPPORT: www.onsemi.com/support

For additional information, please contact your local Sales Representative at www.onsemi.com/support/sales

Looking for pricing, stock, or lifecycle information?

Click below to explore more details on WIN SOURCE:

⊖ [View MBRF2545CT](#) on WIN SOURCE

⊖ [ON Semiconductor](#) Information

Optimize Your Supply Chain with WIN SOURCE Solutions

- ✓ Global Sourcing Solution
- ✓ Obsolete Management
- ✓ Cost Control Management
- ✓ Shortage Management
- ✓ Alternative Solution
- ✓ Excess Inventory Management