



**THE DATASHEET OF
MAX4524EUB**





Low-Voltage, Single-Supply Multiplexer and Switch

MAX4524/MAX4525

General Description

The MAX4524/MAX4525 are low-voltage, single-supply CMOS analog switches configured as a 4-channel multiplexer/demultiplexer (MAX4524) and a double-pole/double-throw (DPDT) switch (MAX4525). Both have an inhibit input to simultaneously open all signal paths.

These devices operate from a single supply of +2V to +12V and are optimized for operation with +3V or +5V supplies. On-resistance is 200Ω with a +5V supply and 500Ω with a +3V supply. Each switch can handle Rail-to-Rail analog signals. The off-leakage current is only 2nA at +25°C or 20nA at +85°C.

All digital inputs have 0.8V to 2.4V logic thresholds, ensuring TTL/CMOS-logic compatibility when using a single +5V supply.

Applications

- Battery-Operated Equipment
- Audio and Video Signal Routing
- Low-Voltage Data-Acquisition Systems
- Communications Circuits

Features

- ◆ Tiny 10-Pin TDFN Package
- ◆ Single-Supply Operation from +2V to +12V
- ◆ 200Ω On-Resistance with +5V Supply
- ◆ 500Ω On-Resistance with +3V Supply
- ◆ Guaranteed 8Ω On-Resistance Match at +5V
- ◆ Guaranteed 2nA Max On-Leakage at +5V
- ◆ TTL/CMOS-Logic Compatible

Ordering Information

PART	TEMP RANGE	PIN-PACKAGE	TOP MARK
MAX4524CUB	0°C to +70°C	10 μMAX	—
MAX4524C/D	0°C to +70°C	Dice*	—
MAX4524EUB	-40°C to +85°C	10 μMAX	—
MAX4524ETB	-40°C to +85°C	10 TDFN-EP** (3mm x 3mm)	AAP
MAX4525CUB	0°C to +70°C	10 μMAX	—
MAX4525C/D	0°C to +70°C	Dice*	—
MAX4525EUB	-40°C to +85°C	10 μMAX	—
MAX4525ETB	-40°C to +85°C	10 TDFN-EP** (3mm x 3mm)	AAQ

*Contact factory for availability.

**EP = Exposed Pad.

Pin Configurations/Functional Diagrams/Truth Tables

TOP VIEW

MAX4524
μMAX

MAX4525
μMAX

TDFN

TDFN

MAX4525

INH	ADD	ON SWITCH
1	X	NONE
0	0	COMA-NCA, COMB-NCB
0	1	COMA-NOA, COMB-NOB

MAX4524

INH	ADDB	ADDA	ON SWITCH
1	X	X	NONE
0	0	0	COM-NO0
0	0	1	COM-NO1
0	1	0	COM-NO2
0	1	1	COM-NO3

X = DON'T CARE



Low-Voltage, Single-Supply Multiplexer and Switch

ABSOLUTE MAXIMUM RATINGS

(Voltages Referenced to GND)

V+	-0.3V, +13V
Voltage into any terminal (Note 1)	-0.3V to (V+ + 0.3V)
Continuous Current into any Terminal	±20mA
Peak Current, NO, NC or COM _n (pulsed at 1ms, 10% duty cycle)	±40mA
ESD per Method 3015.7	>2000V

Continuous Power Dissipation (T_A = +70°C)

10-Pin μMAX (derate 4.1mW/°C above +70°C)	330mW
10-Pin TDFN (derate 24.4mW/°C above +70°C)	1951mW
Operating Temperature Ranges	
MAX452_C_	0°C to +70°C
MAX452_E_	-40°C to +85°C
Storage Temperature Range	-65°C to +150°C

Note 1: Voltages exceeding V+ or GND on any signal terminal are clamped by internal diodes. Limit forward-diode current to maximum current rating.

Stresses beyond those listed under "Absolute Maximum Ratings" may cause permanent damage to the device. These are stress ratings only, and functional operation of the device at these or any other conditions beyond those indicated in the operational sections of the specifications is not implied. Exposure to absolute maximum rating conditions for extended periods may affect device reliability.

ELECTRICAL CHARACTERISTICS—Single +5V Supply

(V+ = 4.5V to 5.5V, GND = 0V, V_{AH} = 2.4V, V_{AL} = 0.8V, T_A = T_{MIN} to T_{MAX}, unless otherwise noted. Typical values are at T_A = +25°C.) (Notes 2, 7)

PARAMETER	SYMBOL	CONDITIONS	TEMP	MIN	TYP (Note 2)	MAX	UNITS
ANALOG SWITCH							
Analog Signal Range	V _{COM} , V _{NO}		C, E	V-		V+	V
COM-NO/NC On-Resistance	R _{ON}	V+ = 4.5V, I _{COM} = 1mA, V _{COM} = 3.5V	+25°C		90	150	Ω
			C, E			200	
COM-NO/NC On-Resistance Match Between Channels (Note 3)	ΔR _{ON}	V+ = 4.5V, I _{COM} = 1mA, V _{COM} = 3.5V	+25°C		2	10	Ω
			C, E			15	
COM-NO/NC On-Resistance Flatness (Note 4)	R _{FLAT}	V+ = 5.5V; I _{COM} = 1mA; V _{COM} = 1.5V, 2.5V, 3.5V	+25°C		5	12	Ω
NO/NC Off-Leakage (Note 5)	I _{NO(OFF)} , I _{NC(OFF)}	V+ = 5.5V; V _{NO} = 1V, 4.5V; V _{COM} = 4.5V, 1V	+25°C	-1		+1	nA
			C, E	-10		+10	
COM Off-Leakage (Note 5)	I _{COM(OFF)}	V+ = 5.5V; V _{NO} = 1V, 4.5V; V _{COM} = 4.5V, 1V	+25°C	-2		+2	nA
		MAX4524	C, E	-50		+50	
		MAX4525	+25°C	-1		+1	
			C, E	-25		+25	
COM On-Leakage (Note 5)	I _{COM(ON)}	V+ = 5.5V; V _{COM} = 4.5V, 1V	+25°C	-2		+2	nA
		MAX4524	C, E	-50		+50	
		MAX4525	+25°C	-1		+1	
			C, E	-25		+25	
DIGITAL I/O							
Logic Input Logic Threshold High	V _{IH}		C, E		1.5	2.4	V
Logic Input Logic Threshold Low	V _{IL}		C, E	0.8	1.5		V
Input Current High	I _{IH}	V _A = V _{INH} = 2.4V	C, E	-1		+1	μA
Input Current Low	I _{IH}	V _A = V _{INH} = 0.8V	C, E	-1		+1	μA

Low-Voltage, Single-Supply Multiplexer and Switch

MAX4524/MAX4525

ELECTRICAL CHARACTERISTICS—Single +5V Supply (continued)

(V+ = 4.5V to 5.5V, GND = 0V, V_{AH} = 2.4V, V_{AL} = 0.8V, T_A = T_{MIN} to T_{MAX}, unless otherwise noted. Typical values are at T_A = +25°C.) (Notes 2, 7)

PARAMETER	SYMBOL	CONDITIONS	TEMP	MIN	TYP (Note 2)	MAX	UNITS
SWITCH DYNAMIC CHARACTERISTICS							
Inhibit Turn-On Time	t _(ON)	V _{NO-} = 3V, R _L = 300Ω, C _L = 35pF, Figure 2	+25°C		90	150	ns
			C, E			200	
Inhibit Turn-Off Time	t _(OFF)	V _{NO-} = 3V, R _L = 300Ω, C _L = 35pF, Figure 2	+25°C		40	120	ns
			C, E			180	
Address Transition Time	t _{TRANS}	V _{NO-} = 3V/0V, R _L = 300Ω, C _L = 35pF, Figure 1	+25°C		90	150	ns
			C, E			200	
Break-Before-Make Time	t _{BBM}	V _{NO-} = 3V, R _L = 300Ω, C _L = 35pF, Figure 3	+25°C	5	20		ns
Charge Injection (Note 6)	Q	C = 1nF, R _S = 0Ω, V _S = 2.5V, Figure 4	+25°C		0.8	5	pC
NO/NC Off-Capacitance	C _{NO(OFF)}	V _{NO-} = 0V, f = 1MHz, Figure 6	+25°C		4		pF
COM Off-Capacitance	C _{COM(OFF)}	V _{NO-} = 0V, f = 1MHz, Figure 6	MAX4524	+25°C		14	pF
			MAX4525	+25°C		6	
COM On-Capacitance	C _{COM(ON)}	V _{NO-} = 0V, f = 1MHz, Figure 6	MAX4524	+25°C		20	pF
			MAX4525	+25°C		12	
Off-Isolation	V _{ISO}	R _L = 50Ω, f = 1MHz, Figure 5	+25°C		-75		dB
Channel-to-Channel Crosstalk (MAX4525)	V _{CT}	R _L = 50Ω, f = 1MHz, Figure 5	+25°C		-74		dB
Total Harmonic Distortion	THD	R _L = 600Ω, V _{COM} = 2.5Vp-p, 20Hz to 20kHz	+25°C		0.2		%
POWER SUPPLY							
Power-Supply Range	V+		C, E	2		12	V
Power-Supply Current	I+	V+ = 5.5V, V _{ADD} = V _{INH} = V+ or 0V	+25°C		-1	+1	μA
			C, E		-10	+10	

ELECTRICAL CHARACTERISTICS—Single +3V Supply

(V+ = 2.7V to 3.6V, GND = 0V, V_{AH} = 2.0V, V_{AL} = 0.5V, T_A = T_{MIN} to T_{MAX}, unless otherwise noted. Typical values are at T_A = +25°C.) (Notes 2, 7)

PARAMETER	SYMBOL	CONDITIONS	TEMP	MIN	TYP (Note 2)	MAX	UNITS	
ANALOG SWITCH								
Analog Signal Range	V _{COM} , V _{NO}		C, E	V-		V+	V	
COM-NO/NC On-Resistance	R _{ON}	V+ = 2.7V, I _{COM} = 0.1mA, V _{COM} = 1.5V	+25°C		190	400	Ω	
			C, E			500		
NO/NC Off-Leakage (Note 6)	I _{NO(OFF)} , I _{NC(OFF)}	V+ = 3.6V; V _{NO} = 1V, 3V; V _{COM} = 3V, 1V	+25°C		-1	+1	nA	
			C, E		-10	+10		
COM Off-Leakage (Note 6)	I _{COM(OFF)}	V+ = 3.6V; V _{NO} = 1V, 3V; V _{COM} = 3V, 1V	MAX4524	+25°C		-2	+2	nA
				C, E		-50	+50	
			MAX4525	+25°C		-1	+1	
				C, E		-25	+25	

Low-Voltage, Single-Supply Multiplexer and Switch

ELECTRICAL CHARACTERISTICS—Single +3V Supply (continued)

($V_+ = 2.7V$ to $3.6V$, $GND = 0V$, $V_{AH} = 2.0V$, $V_{AL} = 0.5V$, $T_A = T_{MIN}$ to T_{MAX} , unless otherwise noted. Typical values are at $T_A = +25^\circ C$.) (Notes 2, 7)

PARAMETER	SYMBOL	CONDITIONS	TEMP	MIN	TYP (Note 2)	MAX	UNITS
COM On-Leakage (Note 6)	$I_{COM(ON)}$	$V_+ = 3.6V$; $V_{COM} = 3V$, $1V$	MAX4524	+25°C	-2	+2	nA
				C, E	-50	+50	
			MAX4525	+25°C	-1	+1	
				C, E	-25	+25	
DIGITAL I/O							
Logic Input Logic Threshold High	V_{IH}		C, E		1.0	2.0	V
Logic Input Logic Threshold Low	V_{IL}		C, E	0.5	1.0		V
Input Current High	I_{IH}	$V_A = V_{INH} = 2.0V$	C, E	-1		+1	μA
Input Current Low	I_{IH}	$V_A = V_{INH} = 0.5V$	C, E	-1		+1	μA
SWITCH DYNAMIC CHARACTERISTICS (Note 6)							
Inhibit Turn-On Time	$t_{(ON)}$	$V_{NO_} = 1.5V$, $R_L = 300\Omega$, $C_L = 35pF$, Figure 2	+25°C		170	300	ns
			C, E			400	
Inhibit Turn-Off Time	$t_{(OFF)}$	$V_{NO_} = 1.5V$, $R_L = 300\Omega$, $C_L = 35pF$, Figure 2	+25°C		50	200	ns
			C, E			300	
Address Transition Time	t_{TRANS}	$V_{NO_} = 1.5V/0V$, $R_L = 300\Omega$, $C_L = 35pF$, Figure 1	+25°C		130	300	ns
			C, E			400	
Break-Before-Make Time	t_{BBM}	Figure 3, $V_{NO_} = 1.5V$, $R_L = 300\Omega$, $C_L = 35pF$	+25°C	5	40		ns
POWER SUPPLY							
Power-Supply Current	I_+	$V_+ = 3.6V$, $V_{ADD} = V_{INH} = V_+$ or $0V$	+25°C	-1		+1	μA
			C, E	-10		+10	

Note 2: The algebraic convention is used in this data sheet; the most negative value is shown in the minimum column.

Note 3: $\Delta R_{ON} = R_{ON(MAX)} - R_{ON(MIN)}$

Note 4: Flatness is defined as the difference between the maximum and minimum value of on-resistance as measured over the specified analog signal ranges; i.e., $V_{NO} = 3V$ to $0V$ and $0V$ to $3V$.

Note 5: Leakage parameters are 100% tested at maximum-rated hot operating temperature, and guaranteed by correlation at $T_A = +25^\circ C$.

Note 6: Guaranteed by design, not production tested.

Note 7: TDFN parts are tested at $+25^\circ C$ and are guaranteed by design and correlation over the entire temperature range.

Low-Voltage, Single-Supply Multiplexer and Switch

Typical Operating Characteristics

($V_+ = 5V$, $GND = 0V$, $T_A = +25^\circ C$, unless otherwise noted.)

MAX4524/MAX4525

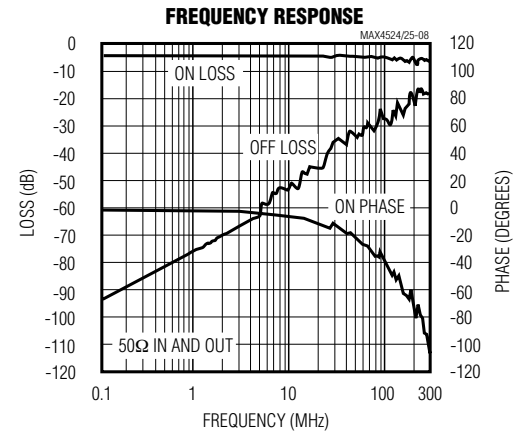
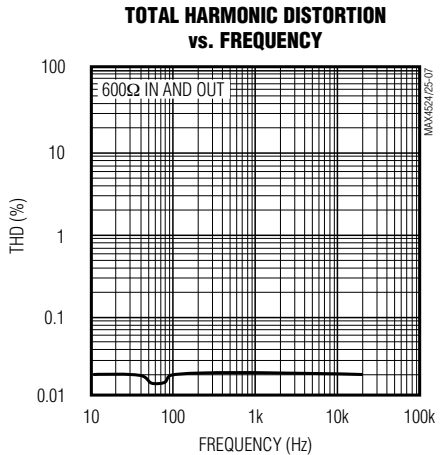
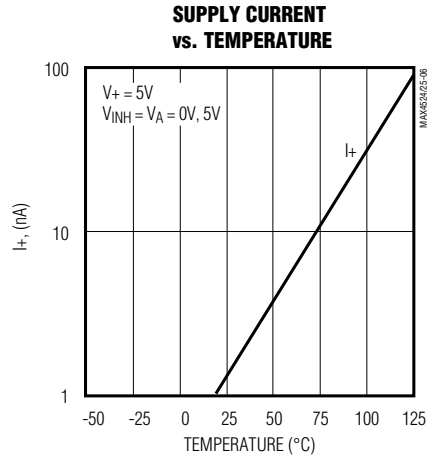
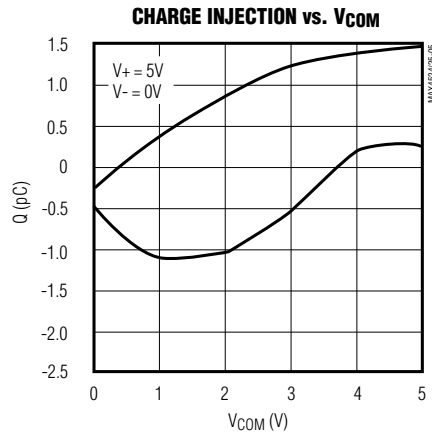
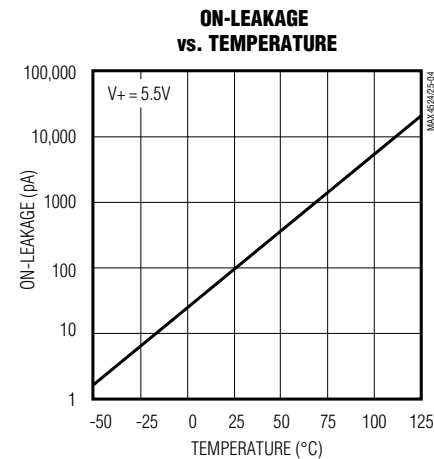
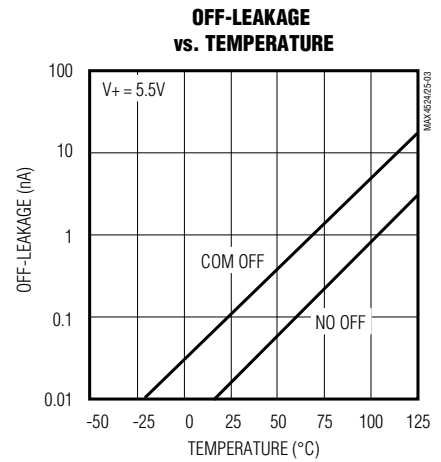
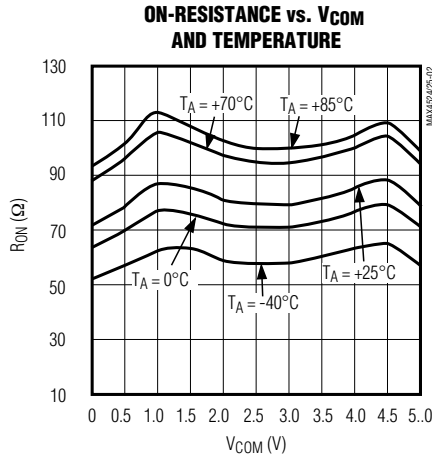
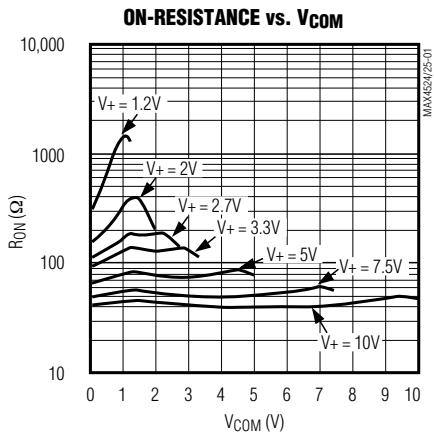

Low-Voltage, Single-Supply Multiplexer and Switch

Typical Operating Characteristics (continued)

(V+ = +5V, GND = 0V, T_A = +25°C, unless otherwise noted.)

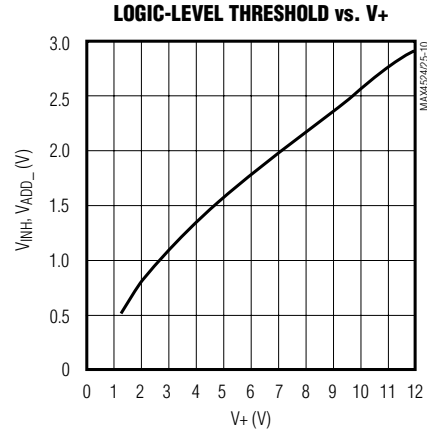
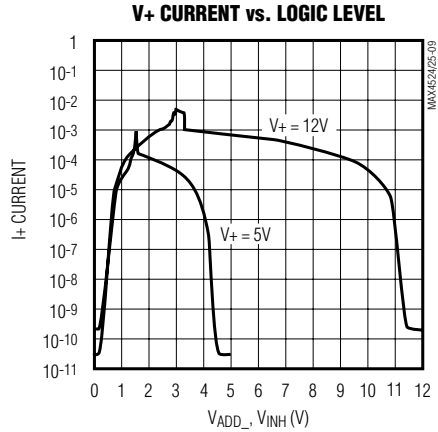

Pin Description

MAX4524	MAX4525	NAME	FUNCTION
1	—	NO2	Analog Switch Normally Open Input 2
—	1	NOA	Analog Switch “A” Normally Open Input
2	—	NO3	Analog Switch Normally Open Input 3
—	2	COMA	Analog Switch “A” Common
3	—	NO1	Analog Switch Normally Open Input 1
—	3	NCA	Analog Switch “A” Normally Closed Input
4	4	INH	Inhibit. Connect to GND for normal operation. Connect to logic-level high to turn all switches off.
5	5	GND	Ground. Connect to digital ground (analog signals have no ground reference, but are limited to V+ and GND).
6	—	ADDB	Logic-Level Address Input (see <i>Truth Tables</i>)
—	6	ADD	Logic-Level Address Input (see <i>Truth Tables</i>)
7	—	ADDA	Logic-Level Address Input (see <i>Truth Tables</i>)
—	7	NCB	Analog Switch “B” Normally Closed Input
8	—	NO0	Analog Switch Normally Open Input 0
—	8	NOB	Analog Switch “B” Normally Open Input
9	—	COM	Analog Switch Common
—	9	COMB	Analog Switch “A” Common
10	10	V+	Positive Analog and Digital Supply-Voltage Input
EP	EP	EP	TDFN Package Only. Exposed pad, connect to V+.

Note: NO₋, NC₋, and COM₋ analog signal pins are identical and interchangeable. Any may be considered an input or output; signals pass equally well in both directions.

Low-Voltage, Single-Supply Multiplexer and Switch

MAX4524/MAX4525

Applications Information

Power-Supply Considerations

The MAX4524/MAX4525's construction is typical of most CMOS analog switches. They have two supply pins: V+ and GND. V+ and GND are used to drive the internal CMOS switches and set the limits of the analog voltage on any switch. Reverse ESD-protection diodes are internally connected between each analog signal pin and both V+ and GND. If any analog signal exceeds V+ or GND, one of these diodes will conduct. During normal operation, these (and other) reverse-biased ESD diodes leak, forming the only current drawn from V+ or GND.

Virtually all the analog leakage current comes from the ESD diodes. Although the ESD diodes on a given signal pin are identical, and therefore fairly well balanced, they are reverse-biased differently. Each is biased by either V+ or GND and the analog signal. This means that leakage will vary as the signal varies. The difference in the two diode leakages to the V+ and GND pins constitutes the analog signal-path leakage current. All analog leakage current flows between each pin and one of the supply terminals, not to the other switch terminal. This is why both sides of a given switch can show leakage currents of either the same or opposite polarity.

Test Circuits/Timing Diagrams

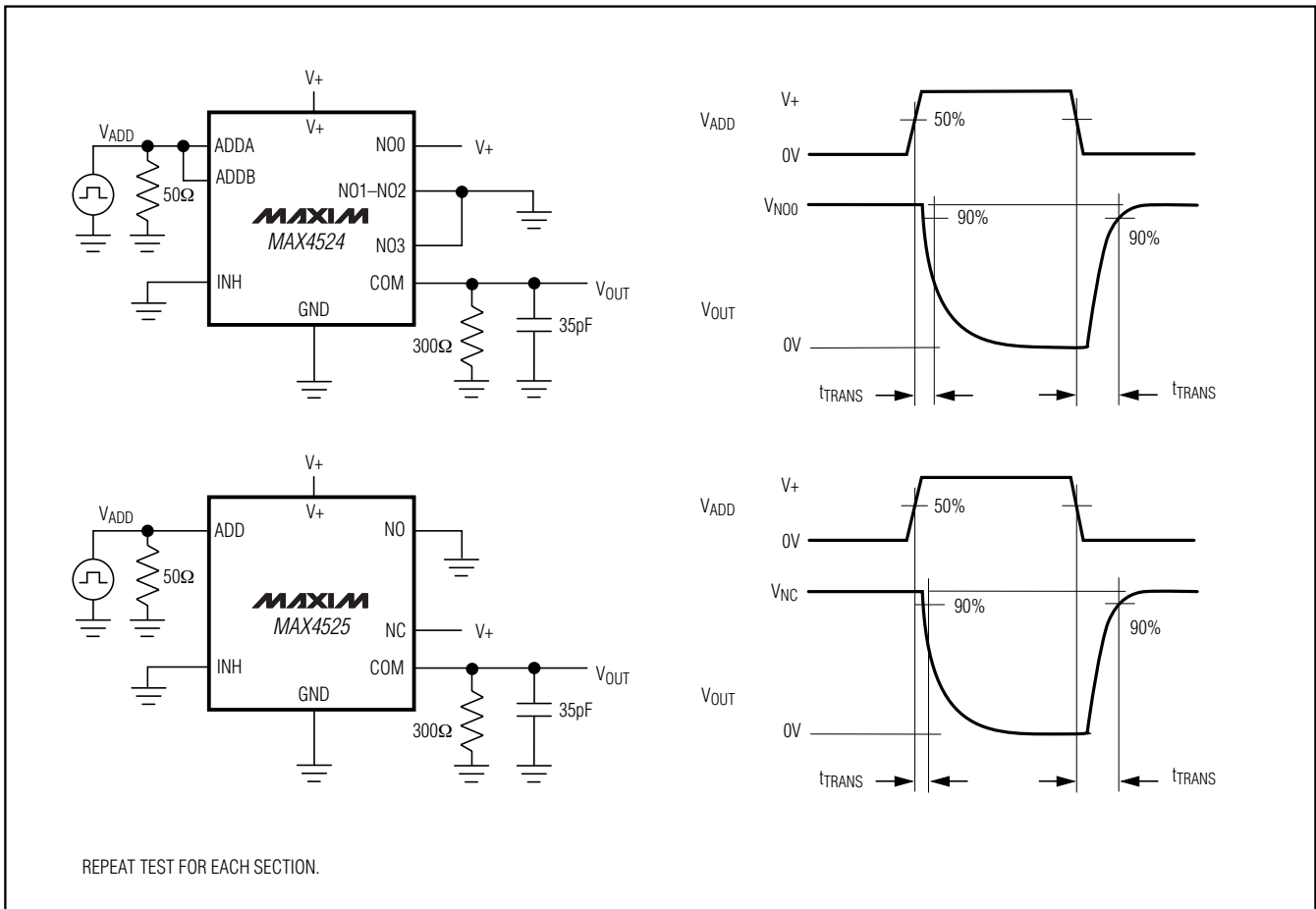

Figure 1. Address Transition Time

Low-Voltage, Single-Supply Multiplexer and Switch

There is no connection between the analog signal paths and GND. V+ and GND power the internal logic and logic-level translators, and set both the input and output logic limits. The logic-level translators convert the logic levels into switched V+ and GND signals to drive the gates of the analog signals. This drive signal is the only connection between the logic supplies (and signals) and the analog supplies. V+ has an ESD-protection diode to GND.

Low-Voltage Operation

These devices operate from a single supply between +2V and +12V. At room temperature, they actually “work” with a single supply at near or below +1.7V, although as supply voltage decreases, switch on-resistance and switching times become very high.

High-Frequency Performance

In 50Ω systems, signal response is reasonably flat up to 50MHz (see *Typical Operating Characteristics*). Above 20MHz, the on-response has several minor peaks, which are highly layout dependent. The problem is not turning the switch on, but turning it off. The off-state switch acts like a capacitor, and passes higher frequencies with less attenuation. At 10MHz, off-isolation is about -50dB in 50Ω systems, becoming worse (approximately 20dB per decade) as frequency increases. Higher circuit impedances also degrade off-isolation. Adjacent channel attenuation is about 3dB above that of a bare IC socket, and is entirely due to capacitive coupling.

Test Circuits/Timing Diagrams (continued)

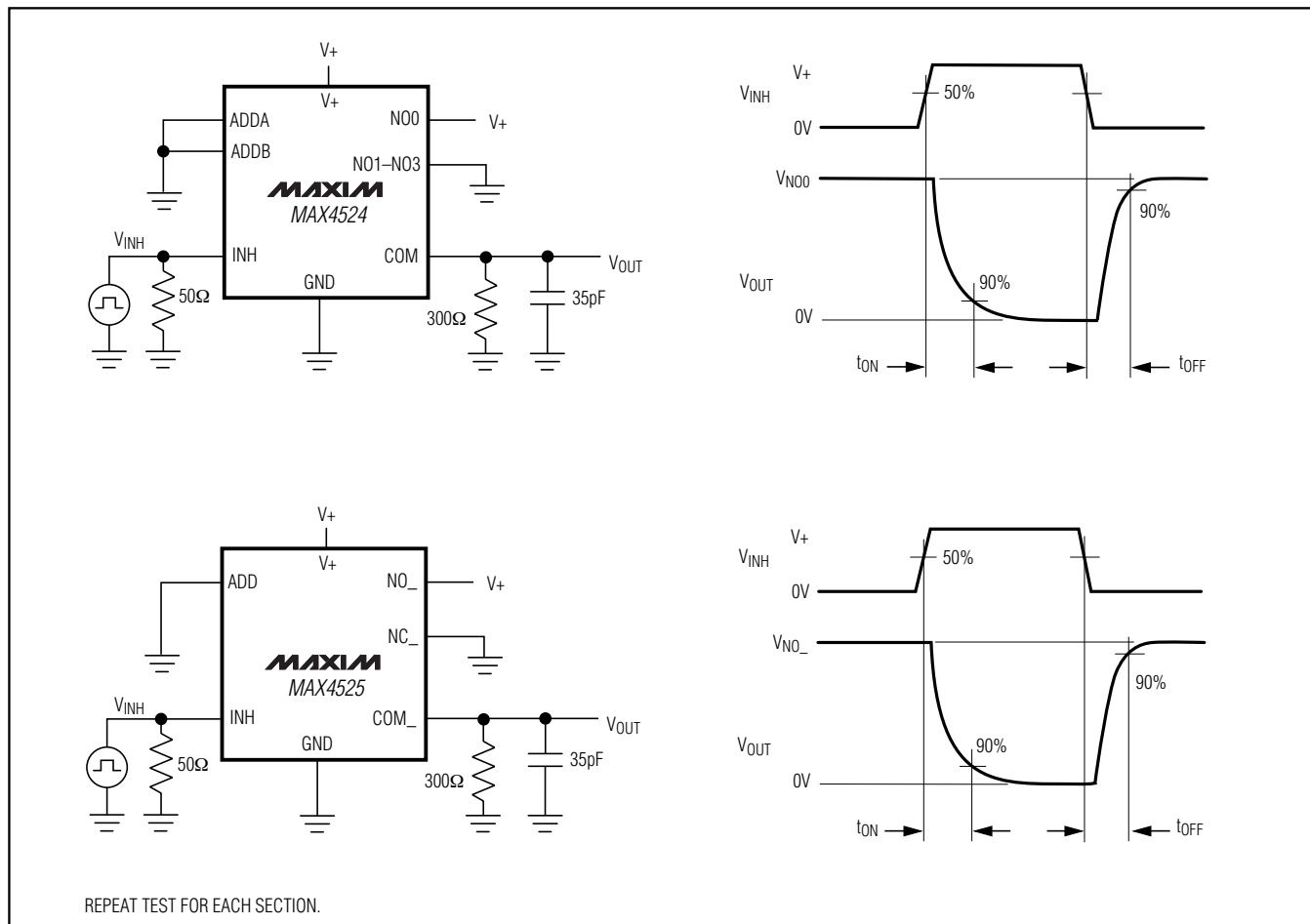

Figure 2. Inhibit Switching Times

Low-Voltage, Single-Supply Multiplexer and Switch

Test Circuits/Timing Diagrams (continued)

MAX4524/MAX4525

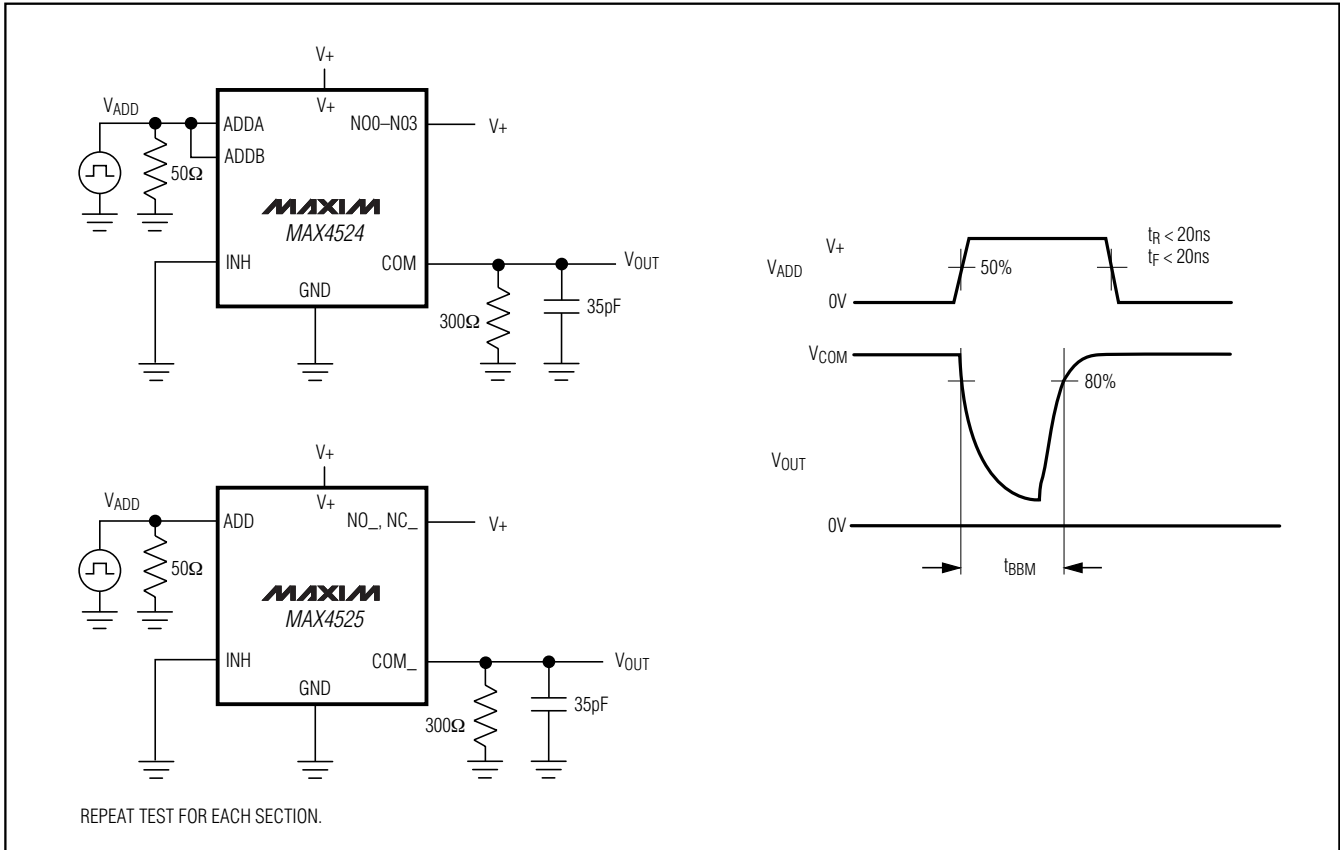

Figure 3. Break-Before-Make Interval

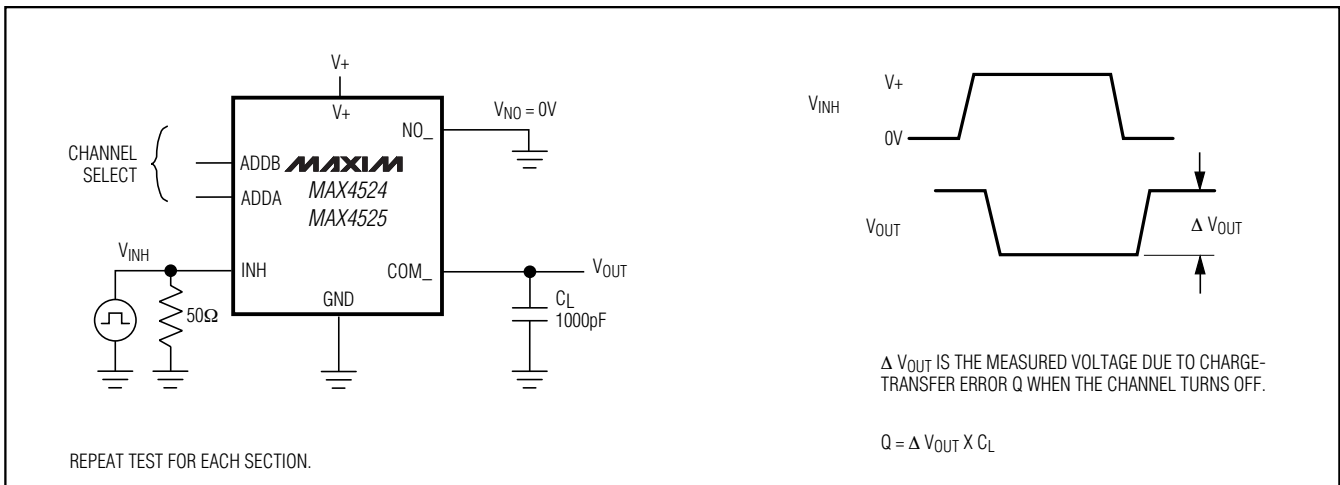

Figure 4. Charge Injection

Low-Voltage, Single-Supply Multiplexer and Switch

Chip Topographies

MAX4524/MAX4525

MAX4524

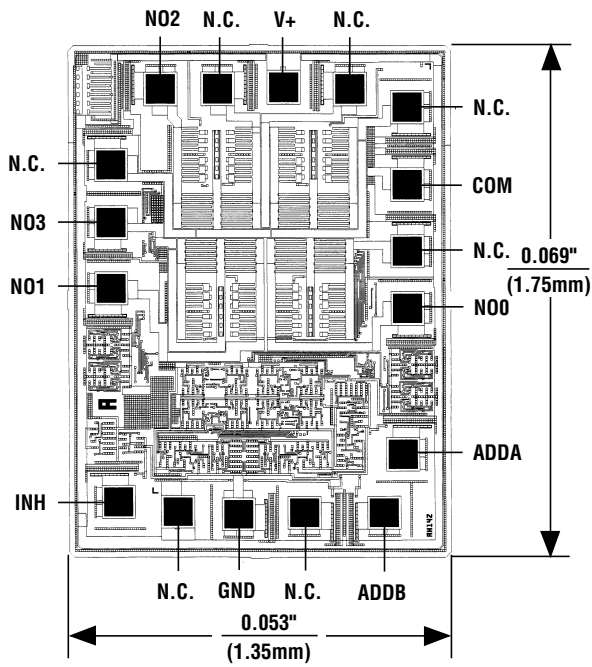

MAX4525

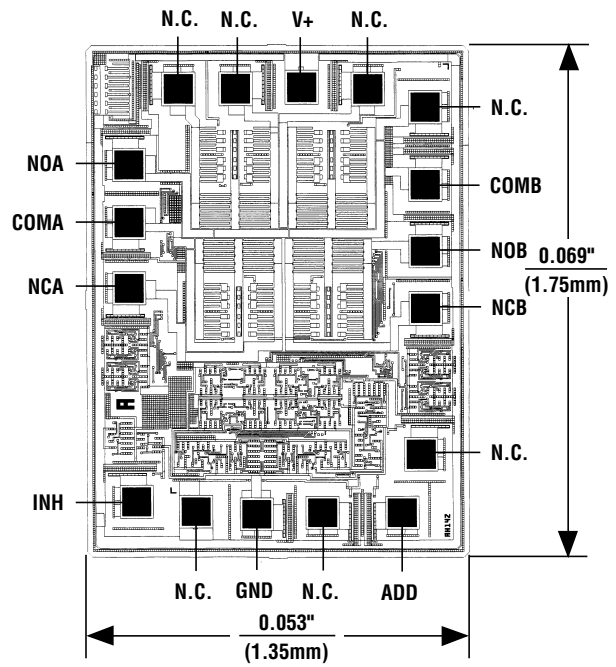

N.C. = No Connection

TRANSISTOR COUNT: 219
SUBSTRATE CONNECTED TO V+

Low-Voltage, Single-Supply Multiplexer and Switch

Package Information

(The package drawing(s) in this data sheet may not reflect the most current specifications. For the latest package outline information go to www.maxim-ic.com/packages.)

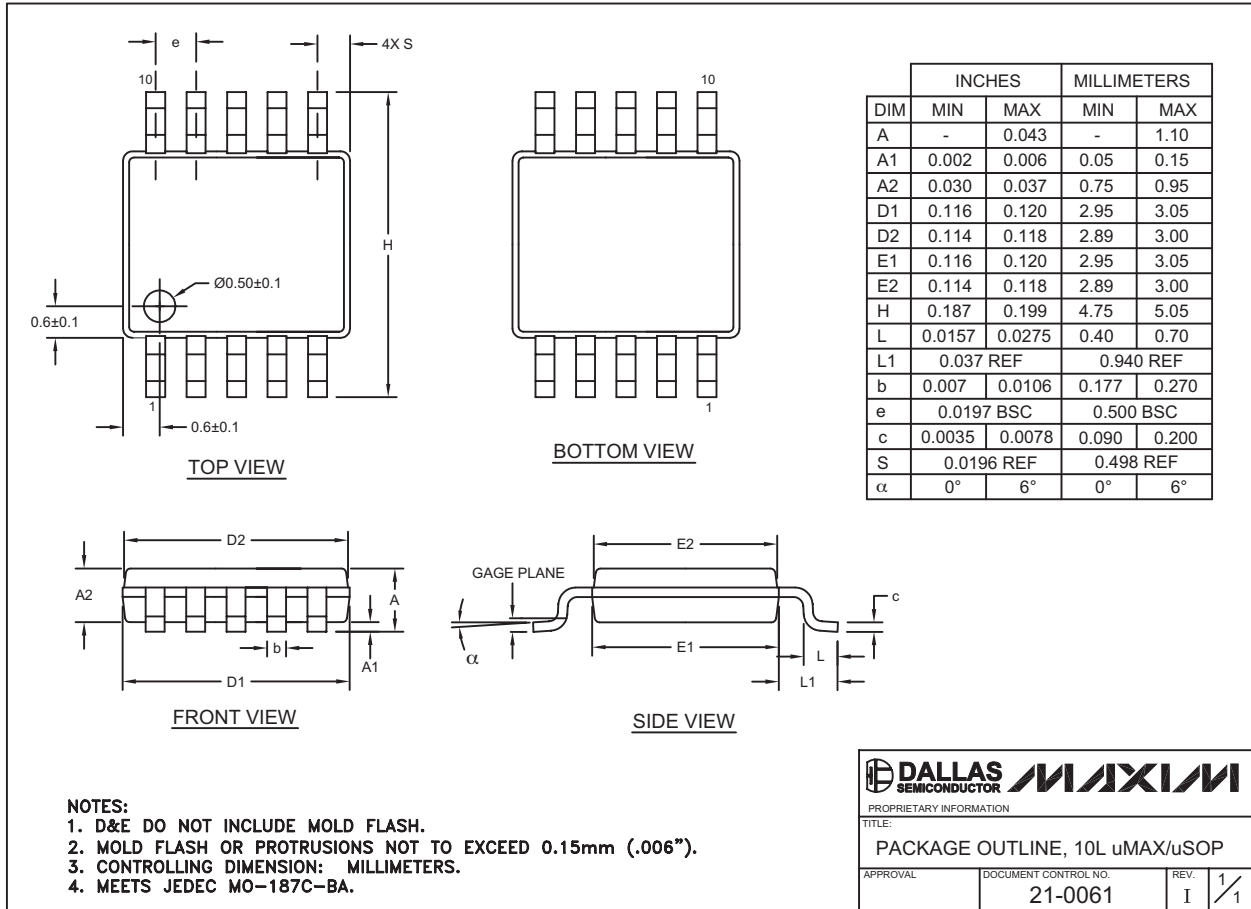

10LUMAX.EPS

Low-Voltage, Single-Supply Multiplexer and Switch

Package Information (continued)

(The package drawing(s) in this data sheet may not reflect the most current specifications. For the latest package outline information go to www.maxim-ic.com/packages.)



COMMON DIMENSIONS		
SYMBOL	MIN.	MAX.
A	0.70	0.80
D	2.90	3.10
E	2.90	3.10
A1	0.00	0.05
L	0.20	0.40
k	0.25 MIN.	
A2	0.20 REF.	

PACKAGE VARIATIONS							
PKG. CODE	N	D2	E2	e	JEDEC SPEC	b	[(N/2)-1] x e
T633-2	6	1.50±0.10	2.30±0.10	0.95 BSC	MO229 / WEEA	0.40±0.05	1.90 REF
T833-2	8	1.50±0.10	2.30±0.10	0.65 BSC	MO229 / WEEC	0.30±0.05	1.95 REF
T833-3	8	1.50±0.10	2.30±0.10	0.65 BSC	MO229 / WEEC	0.30±0.05	1.95 REF
T1033-1	10	1.50±0.10	2.30±0.10	0.50 BSC	MO229 / WEED-3	0.25±0.05	2.00 REF
T1033-2	10	1.50±0.10	2.30±0.10	0.50 BSC	MO229 / WEED-3	0.25±0.05	2.00 REF
T1433-1	14	1.70±0.10	2.30±0.10	0.40 BSC	----	0.20±0.05	2.40 REF
T1433-2	14	1.70±0.10	2.30±0.10	0.40 BSC	----	0.20±0.05	2.40 REF

NOTES:

1. ALL DIMENSIONS ARE IN mm. ANGLES IN DEGREES.
 2. COPLANARITY SHALL NOT EXCEED 0.08 mm.
 3. WARPAGE SHALL NOT EXCEED 0.10 mm.
 4. PACKAGE LENGTH/PACKAGE WIDTH ARE CONSIDERED AS SPECIAL CHARACTERISTIC(S).
 5. DRAWING CONFORMS TO JEDEC MO229, EXCEPT DIMENSIONS "D2" AND "E2", AND T1433-1 & T1433-2.
 6. "N" IS THE TOTAL NUMBER OF LEADS.
 7. NUMBER OF LEADS SHOWN ARE FOR REFERENCE ONLY.
-  MARKING IS FOR PACKAGE ORIENTATION REFERENCE ONLY.

—DRAWING NOT TO SCALE—

			
TITLE: PACKAGE OUTLINE, 6,8,10 & 14L, TDFN, EXPOSED PAD, 3x3x0.80 mm			
APPROVAL	DOCUMENT CONTROL NO. 21-0137	REV. I	2/2

Revision History

Pages changed at Rev 2: 1, 2, 4, 6, 13,14

Maxim cannot assume responsibility for use of any circuitry other than circuitry entirely embodied in a Maxim product. No circuit patent licenses are implied. Maxim reserves the right to change the circuitry and specifications without notice at any time.

14 **Maxim Integrated Products, 120 San Gabriel Drive, Sunnyvale, CA 94086 408-737-7600**

Looking for pricing, stock, or lifecycle information?

Click below to explore more details on WIN SOURCE:

- ⊖ [View MAX4524EUB](#) on WIN SOURCE
- ⊖ [Maxim Integrated](#) Information

Optimize Your Supply Chain with WIN SOURCE Solutions

- ✓ Global Sourcing Solution
- ✓ Obsolete Management
- ✓ Cost Control Management
- ✓ Shortage Management
- ✓ Alternative Solution
- ✓ Excess Inventory Management