



**THE DATASHEET OF
LV8762T-MPB-H**



LV8762T

Motor Driver, H-bridge, Forward / Reverse

Overview

The LV8762T is an 1ch H-bridge driver that can control four operation modes (forward, reverse, brake, and standby) of a motor. The IC is optimal for use in driving brushed DC motors for office equipment.

Features

- Forward/reverse H-bridge motor driver: 1 channel
- $I_{Omax} = 1A$
- Built-in current limiter
- Current limit mask function
- Built-in thermal shutdown circuit
- Alert signal output
- Single power supply
- Built-in short-circuit protection function (selectable from latch-type or auto reset-type).

Applications

- Brush DC Motors
- Computing & Peripherals
- Industrial

Specifications

Absolute Maximum Ratings at $T_a = 25^\circ C$ (Note 1,3,4)

Parameter	Symbol	Conditions	Ratings	Unit
Supply voltage	V_M max		36	V
Output peak current	$I_{O peak}$	$tw \leq 10ms$, duty 20%	1.5	A
Output continuous current	I_O max		1.0	A
Logic input voltage	V_{IN} max	ST, IN1, IN2, EMM	-0.3 to +6	V
EMO pin input voltage	V_{EMO}		-0.3 to +6	V
Allowable power dissipation	P_d max	Mounted on a specified board. (Note 2)	1.4	W
Operating temperature	T_{opr}		-20 to +85	$^\circ C$
Storage temperature	T_{stg}		-55 to +150	$^\circ C$

1. Stresses exceeding those listed in the Maximum Rating table may damage the device. If any of these limits are exceeded, device functionality should not be assumed, damage may occur and reliability may be affected.
2. Specified circuit board : 57mm×57mm×1.6mm, glass epoxy both-type board.
3. Absolute maximum ratings represent the value which cannot be exceeded for any length of time
4. Even when the device is used within the range of absolute maximum ratings, as a result of continuous usage under high temperature, high current, high voltage, or drastic temperature change, the reliability of the IC may be degraded. Please contact us for the further details



ON Semiconductor®

www.onsemi.com

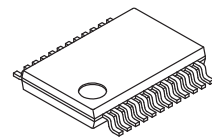

TSSOP24 (225mil)

GENERIC MARKING DIAGRAM

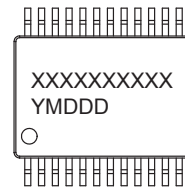

XXXXX = Specific Device Code
Y = Year
M = Month
DDD = Additional Traceability Data

ORDERING INFORMATION

Ordering Code:
LV8762T-TLM-H
LV8762T-MPB-H

Package
TSSOP24 (225mil)
(Pb-Free / Halogen Free)

Shipping (Qty / packing)
2000 / Tape & Reel --- (TLM)
70 / Fan-Fold --- (MPB)

† For information on tape and reel specifications, including part orientation and tape sizes, please refer to our Tape and Reel Packaging Specifications Brochure, BRD8011/D.
http://www.onsemi.com/pub_link/Collateral/BRD8011-D.PDF

LV8762T

Recommended Operating Ranges at Ta = 25°C (Note 5)

Parameter	Symbol	Conditions	Ratings	Unit
Supply voltage range	VM		9 to 32	V
VREF input voltage	VREF		0 to 3	V
Logic input voltage	V _{IN}	ST, IN1, IN2, EMM	0 to 5.5	V

5. Functional operation above the stresses listed in the Recommended Operating Ranges is not implied. Extended exposure to stresses beyond the Recommended Operating Ranges limits may affect device reliability.

Electrical Characteristics at Ta = 25°C, VM = 24 V, VREF = 1.5 V (Note 6)

Parameter	Symbol	Conditions	Ratings			Unit	
			min	typ	max		
General							
Standby mode current drain	IMst	ST = "L"		100	400	μA	
Operating mode current drain	IM	ST = "H", IN1 = "H", IN2 = "L", with no load		3	5	mA	
REG5 output voltage	VREG	I _O = -1mA	4.5	5	5.5	V	
Thermal shutdown temperature	TSD	Design guarantee (Note 7)	150	180	200	°C	
Thermal hysteresis width	ΔTSD	Design guarantee (Note 7)		40		°C	
Output block							
Output on resistance	RonU	I _O = 1A, upper side ON resistance		0.75	0.97	Ω	
	RonD	I _O = -1A, under side ON resistance		0.5	0.65	Ω	
Output leakage current	I _{Oleak}	V _O = 32V			50	μA	
Diode forward voltage	VD	ID = -1A		1.2	1.4	V	
Rising time	tr	10% to 90%		100	200	ns	
Falling time	tf	90% to 10%		100	200	ns	
Input output delay time	tpLH	IN1 to OUTA, IN2 to OUTB (L → H)		550	750	ns	
	tpHL	IN1 to OUTA, IN2 to OUTB (H → L)		550	750	ns	
Control system input block							
Logic input voltage	High	V _{INH}	ST, IN1, IN2, EMM	2.0		5.5	V
	Low			V _{INL}	0		0.8
Logic pin input current 1	I _{INL}	ST, IN1, IN2, EMM V _{IN} = 0.8V	4	8	12	μA	
	I _{INH}		V _{IN} = 5V	30	50	70	μA
VREF input current	IREF	VREF = 1.5V	-0.5			μA	
Current limit comparator threshold voltage	Vtlim	VREF = 1.5V	0.291	0.3	0.309	V	
CHOP pin charge current	I _{CHOP}		-6.5	-5	-3.5	μA	
CHOP pin threshold voltage	VtCHOP		0.8	1	1.2	V	
CMK pin charge current	I _{CMK}		-32.5	-25	-17.5	μA	
CMK pin threshold voltage	VtCMK		1.2	1.5	1.8	V	
Charge pump block							
Step-up voltage	VGH	VM = 24V	27.7	28.7	29.7	V	
Rising time	tONG	VG = 0.1μF		250	550	μs	
Oscillation frequency	Fcp		90	125	155	kHz	
Short-circuit protection block							
EMO output saturation voltage	V _{EMO}	I _{EMO} = 1mA			0.4	V	
SCP pin charge current	I _{SCP}	SCP = 0V	-6.5	-5	-3.5	μA	
Comparator threshold voltage	VtSCP		0.8	1	1.2	V	

6. Functional operation above the stresses listed in the Recommended Operating Ranges is not implied. Extended exposure to stresses beyond the Recommended Operating Ranges limits may affect device reliability.

7. Design guarantee value and no measurement is made.

LV8762T

Package Dimensions

unit : mm

TSSOP24 4.4x6.5 / TSSOP24 (225 mil)

CASE 948BA

ISSUE A

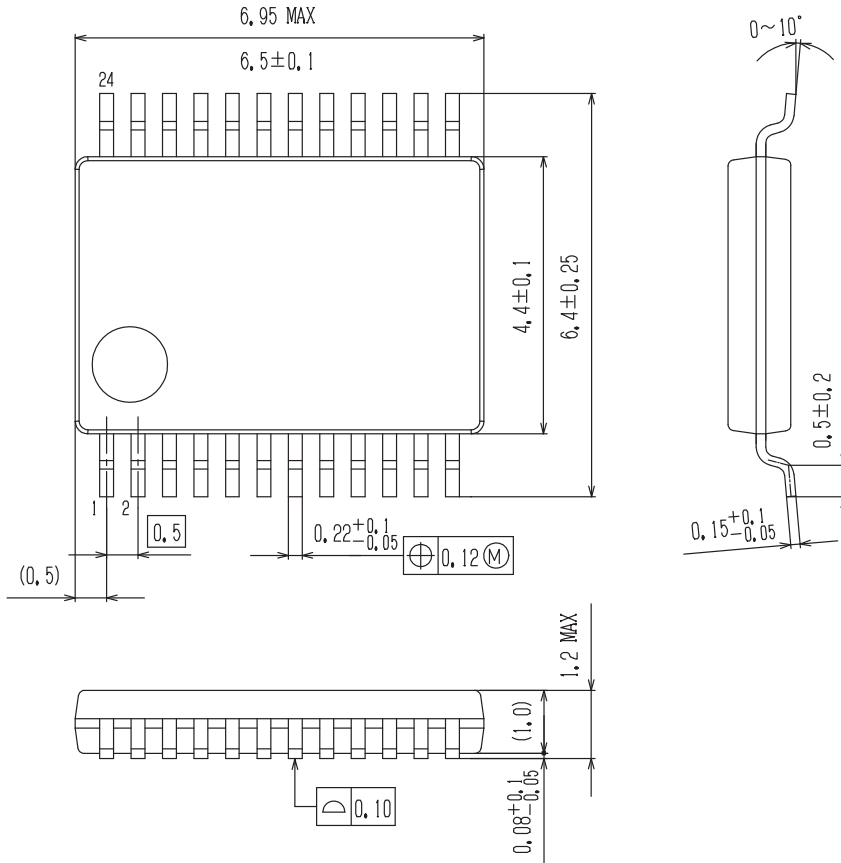

SOLDERING FOOTPRINT*

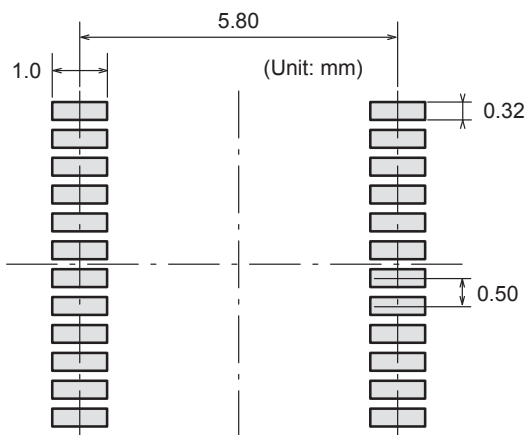

NOTE: The measurements are not to guarantee but for reference only.

*For additional information on our Pb-Free strategy and soldering details, please download the ON Semiconductor Soldering and Mounting Techniques Reference Manual, SOLDERM/D.

LV8762T

Pin Assignment

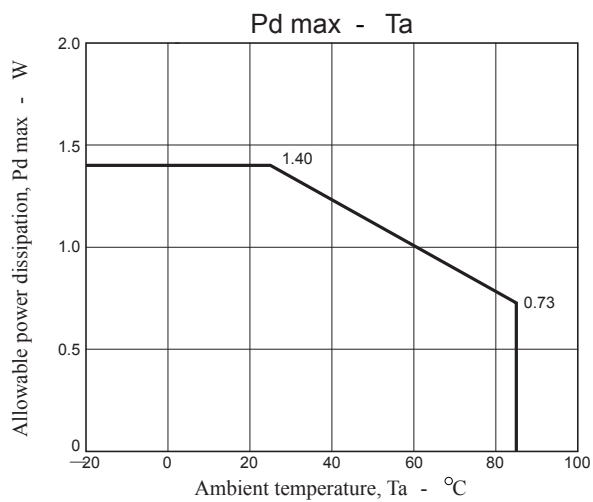
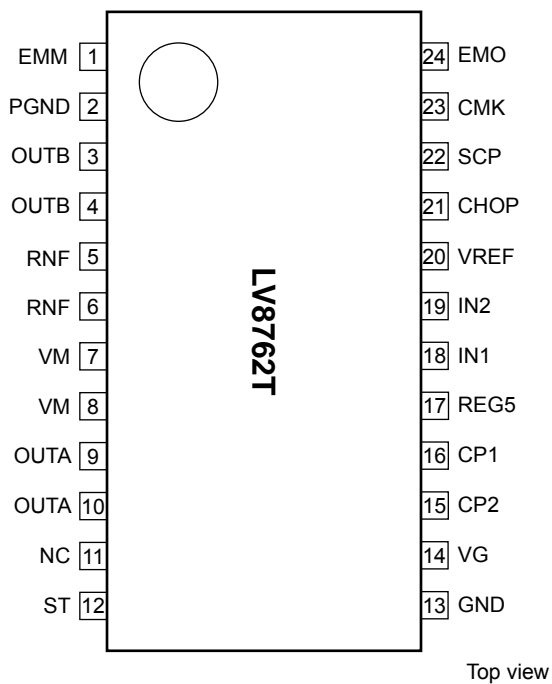

LV8762T

Substrate Specifications (Substrate recommended for operation of LV8762T)

Size : 57mm × 57mm × 1.6mm (two-layer substrate)
Material : Glass epoxy both-type board

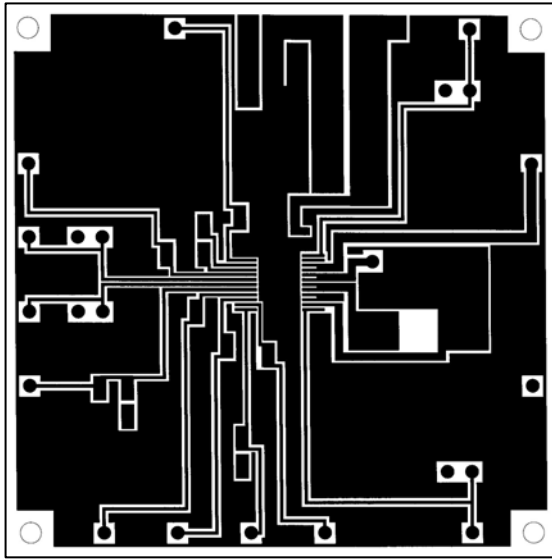

L1 : Copper wiring pattern diagram

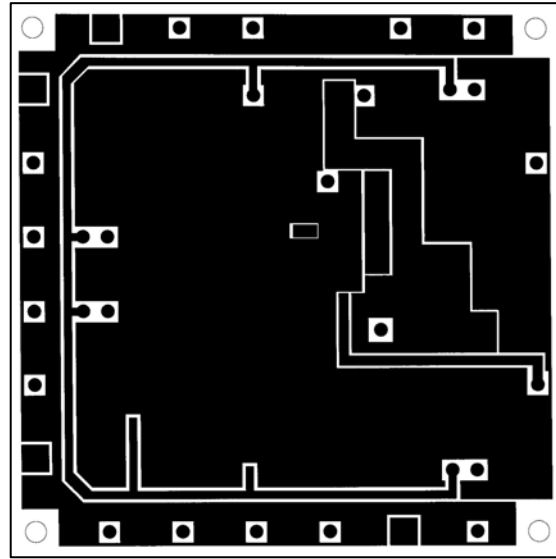

L2 : Copper wiring pattern diagram

Cautions

- 1) For the set design, employ the derating design with sufficient margin.
Stresses to be derated include the voltage, current, junction temperature, power loss, and mechanical stresses such as vibration, impact, and tension.
Accordingly, the design must ensure these stresses to be as low or small as possible.
The guideline for ordinary derating is shown below :
 - (1)Maximum value 80% or less for the voltage rating
 - (2)Maximum value 80% or less for the current rating
 - (3)Maximum value 80% or less for the temperature rating
- 2) After the set design, be sure to verify the design with the actual product.
Confirm the solder joint state and verify also the reliability of solder joint for the Exposed Die-Pad, etc.
Any void or deterioration, if observed in the solder joint of these parts, causes deteriorated thermal conduction, possibly resulting in thermal destruction of IC.

LV8762T

Block Diagram

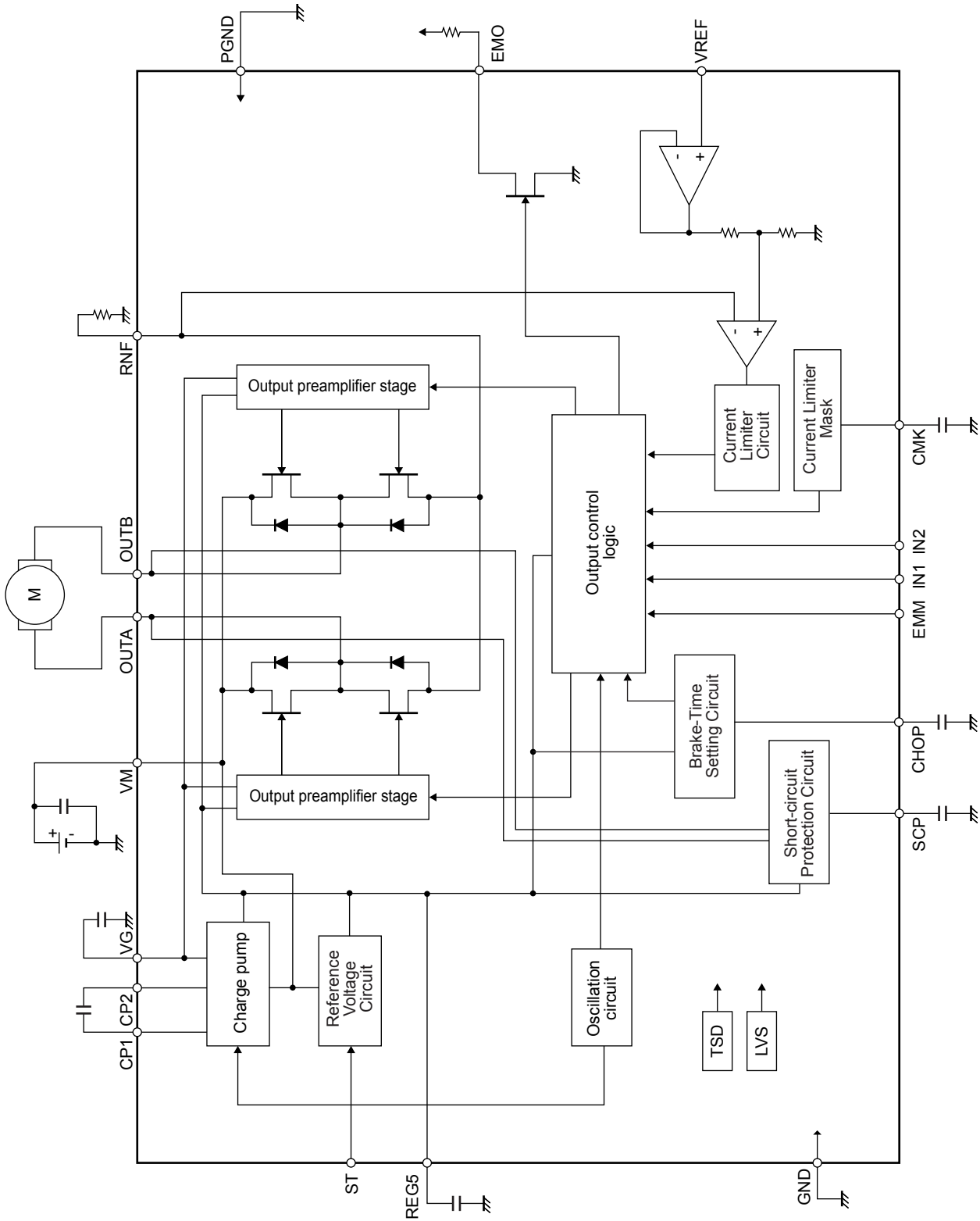

LV8762T

Pin Functions

Pin No.	Pin Name	Pin Function	Equivalent Circuit
18 19 1	IN1 IN2 EMM	Output control signal input pin 1. Output control signal input pin 2. Short protection mode setting.	
12	ST	Standby mode setting	
9, 10 3, 4 7, 8 5, 6 2	OUTA OUTB VM RNF PGND	OUTA output pin. OUTB output pin. Motor power-supply connection pin. Current sense resistor connection pin. Power ground.	
14 8 16 15	VG VM CP1 CP2	Charge pump capacitor connection pin. Motor power-supply connection pin. Charge pump capacitor connection pin. Charge pump capacitor connection pin.	

Continued on next page.

LV8762T

Continued from preceding page.

Pin No.	Pin Name	Pin Function	Equivalent Circuit
20	VREF	Reference voltage input pin for output current limit setting.	
17	REG5	Internal reference voltage output pin.	
24	EMO	Alert signal output	
21 22	CHOP SCP	Capacitor connection for current limit break time setting Capacitor connection for short detection time setting	

Continued on next page.

LV8762T

Continued from preceding page.

Pin No.	Pin Name	Pin Function	Equivalent Circuit
23	CMK	Capacitor connection for current limit mask setting	

LV8762T

Description of operation

1. Input Pin Function

Each input terminal has the function to prevent the flow of the current from an input to a power supply. Therefore, Even if a power supply (VM) is turned off in the state that applied voltage to an input terminal, the electric current does not flow into the power supply.

1-1) Chip enable function

This IC is switched between standby and operating mode by setting the ST pin. In standby mode, the IC is set to power-save mode and all logic is reset. In addition, the internal regulator circuit and charge pump circuit do not operate in standby mode.

ST	mode	Internal regulator	Charge pump
"L" or OPEN	Standby mode	standby	standby
"H"	Operation mode	operation	operation

1-2) DCM output control logic

Contol Input			Output		Mode
ST	IN1	IN2	OUTA	OUTB	
L	*	*	OFF	OFF	Standby
H	L	L	OFF	OFF	Output OFF
H	H	L	H	L	CW (forward)
H	L	H	L	H	CCW (reverse)
H	H	H	L	L	Brake

1-3) Current limit control timing chart

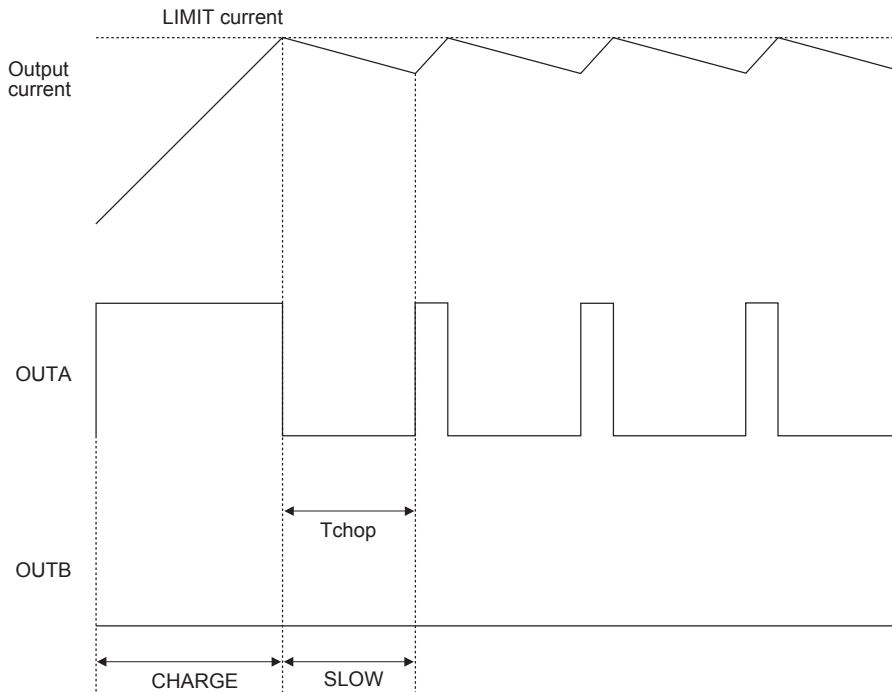

LV8762T

1-4) Setting the time of current limit brake value

This IC can set the time of the current limit break by connecting the capacitor with CHOP-GND. The value of the capacitor is decided according to the following expression.

$$\text{brake time: } T_{\text{CHOP}} \approx C_{\text{CHOP}} \times V_{\text{tCHOP}} \div I_{\text{CHOP}} \text{ [sec]}$$

V_{tCHOP} :CHOP comparator threshold voltage. TYP = 1.0 [V]
 I_{CHOP} :CHOP charge current. TYP = 5 [μA]

ex. $C_{\text{chop}} = 50[\text{pF}]$
 $T_{\text{chop}}[\text{sec}] = 50[\text{pF}] \times 1.0[\text{V}] \div 5[\mu\text{A}] = 10[\mu\text{s}]$

1-5)Setting the current limit value

The current limit value of the DCM driver is determined by the VREF voltage and the resistance (RNF) connected across the RNF and GND pins using the following formula :

$$I_{\text{limit}} \text{ [A]} \approx (V_{\text{REF}} \text{ [V]} \div 5) \div R_{\text{NF}} \text{ [}\Omega\text{]}$$

Assuming $V_{\text{REF}} = 1.5\text{V}$, $R_{\text{NF}} = 1\Omega$, the current limit is :
 $I_{\text{limit}} = 1.5\text{V} \div 5 \div 1 \Omega = 0.3 \text{ A}$

1-6) Setting the mask of current limit

CMK	mask of current limit
"L"	no operation
"H" or OPEN	operation

This function can be switched by CMK pin.

This function can prevent the current limit from working by the motor start-up current when the current limit value is set low.

1-7) Setting the time of the mask of current limit

This IC can set the time of the mask of current limit by connection the capacitor with CMK-GND. The value of the capacitor is decided according to the following expression.

$$\text{Time of mask: } T_{\text{CMK}} \approx C_{\text{CMK}} \times V_{\text{tCMK}} \div I_{\text{CMK}} \text{ [sec]}$$

V_{tCMK} :CMK comparator threshold voltage. TYP = 1.0 [V]
 I_{CMK} :CMK charge current. TYP = 25 [μA]

ex. $C_{\text{CMK}} = 0.1 \text{ [}\mu\text{F]}$
 $T_{\text{CMK}}[\text{sec}] = 0.1 \text{ [}\mu\text{F}] \times 1.5 \text{ [V]} \div 25 \text{ [}\mu\text{A]} = 6[\text{ms}]$

2.Output short-circuit protection function

This IC incorporates an output short-circuit protection circuit. It turns the output off to prevent destruction of the IC if a problem such as an output pin being shorted to the motor power supply or ground occurs. Then short-circuit detected, alert signal is assert to EMO pin.

2-1) Output short protect mode

This function can be switched by EMM pin. EMM pin is L or OPEN then latch method, H then auto-retry method.

EMM Pin	Method
"L" or OPEN	Latch
"H"	Auto retry

LV8762T

2-2) Protection function operation (Latch method)

The short-circuit protection circuit is activated when it detects the output short-circuit state. If the short-circuit state continues for the internally preset period ($\approx 2 \mu\text{s}$), the protection circuit turns off the output from which the short-circuit state has been detected. Then it turns the output on again after a lapse of the timer latch time (T_{SCP}) described later. If the short-circuit state is still detected, it changes all the outputs to the standby mode and retains the state. The latched state is released by setting the ST to L.

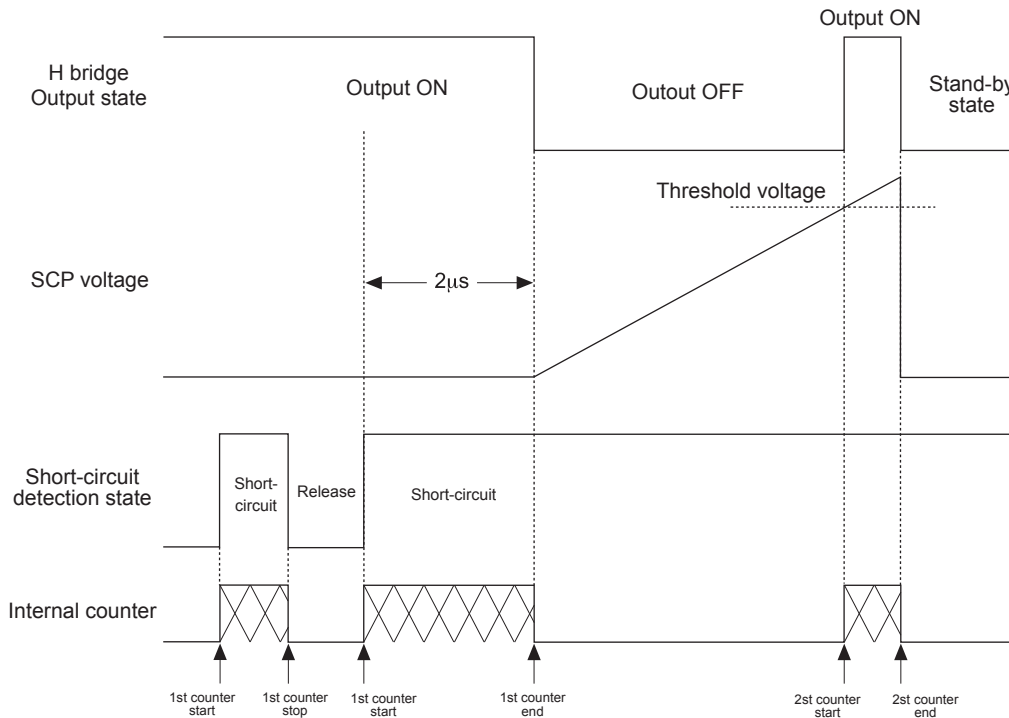

2-3) Protection function operation (Auto retry method)

In this mode, short-protection function try repeatedly to detecting short-circuit.

The short-circuit detection circuit operates when a short output is detected as well as the latch method. The output is switched to the standby mode when the operation of the short-circuit detection circuit exceeds time (T_{SCP}) of the timer latch, and it returns to the turning on mode again after 2 ms (typ). At this time, the switching mode is repeated when is still in the overcurrent mode until the overcurrent mode is made clear.

2-4) Unusual Condition Warning Output Pin (EMO)

The LV8762T is provided with the EMO pin which notifies the CPU of an unusual condition if the protection circuit operates by detecting an abnormal condition of the IC. This pin is of the open-drain output type, and if abnormality is detected, the EMO output becomes (EMO=L) of on.

The EMO pin is placed in the ON state when one of the following conditions occurs.

1. Shorting-to-power or shorting-to-ground occurs at the output pin and the output short-circuit protection circuit is activated.
2. The IC junction temperature rises and the thermal protection circuit is activated.

2-5) Timer latch-up (T_{SCP})

The user can set the time at which the outputs are turned off when a short-circuit occurs by connecting a capacitor (C_{SCP}) across the SCP and GND pins. The value of the capacitor (C_{SCP}) can be determined by the following formula :

Timer latch-up : T_{SCP}

$$T_{\text{SCP}} \approx C_{\text{SCP}} \times V_{\text{tSCP}} \div I_{\text{SCP}} [\text{sec}]$$

V_{tSCP} : Comparator threshold voltage (1 V typical)

I_{SCP} : SCP charge current (5 μA typical)

LV8762T

3. Thermal shutdown function

The thermal shutdown circuit is included, and the output is turned off when junction temperature T_j exceeds 180°C , and the abnormal state warning output(EMO pin) is turned on at the same time.

When the temperature falls hysteresis level, output is driven again (automatic restoration) The thermal shutdown circuit doesn't guarantee protection of the set and the destruction prevention because it works at the temperature that is higher than rating ($T_{j\text{max}} = 150^\circ\text{C}$) of the junction temperature

$T_{SD}=180^\circ\text{C}$ (typ)

$\Delta T_{SD}=40^\circ\text{C}$ (typ)

4. Charge pump Circuit

When the ST pin is set High, the charge pump circuit operates and the VG pin voltage is boosted from the VM voltage to the VM+VREG5 voltage.

If the VG pin voltage is not boosted to $VM + 4\text{ V}$ or more, the output pin cannot be turned on. Therefore it is recommended that the drive of the motor is started after the time has passed t_{ONG} or more.

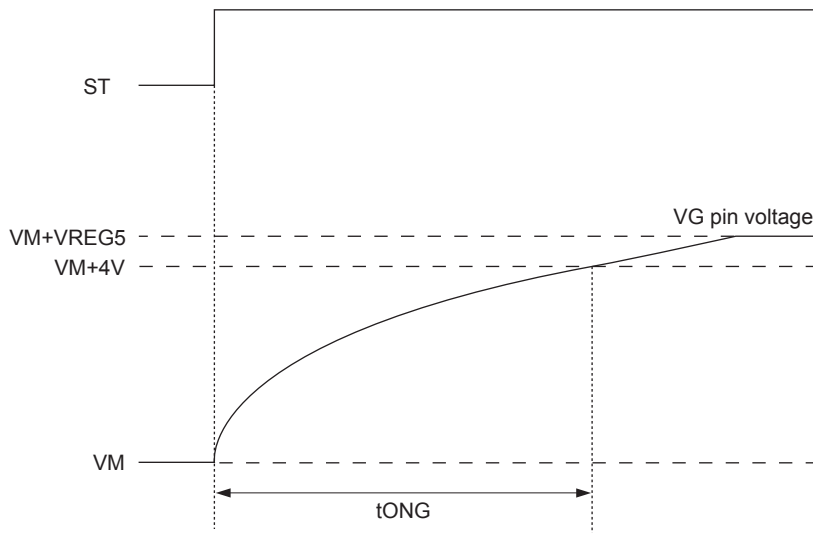

LV8762T

5.Application Circuit Example

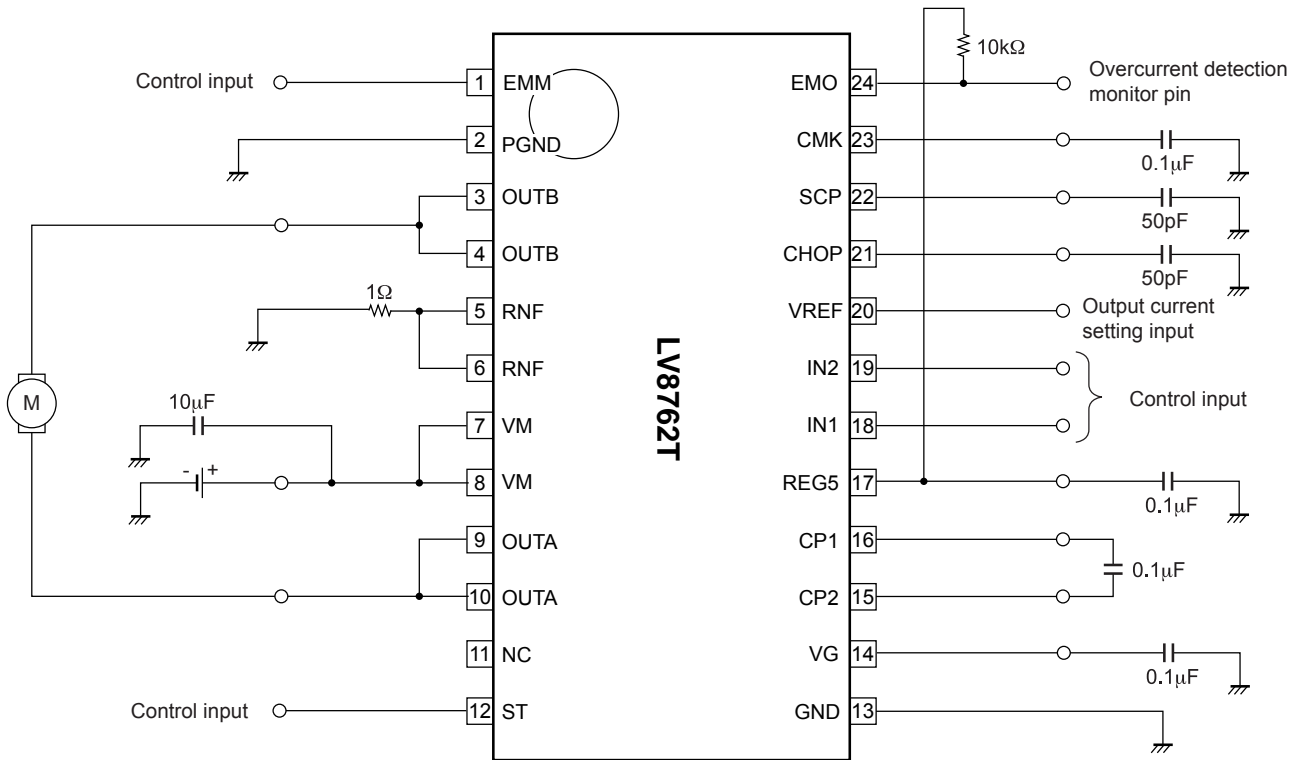

Current limit value

When $V_{REF} = 1.5 \text{ V}$,

$$I_{limit} = V_{ref} \div 5 \div R_{NF} \\ = 1.5 \text{ V} \div 5 \div 1 \Omega = 0.3 \text{ A}$$

Setting the current limit regeneration time and short-circuit detection time

$$T_{SCP} \approx C_{SCP} \times V_{tSCP} \div I_{SCP} \\ = 50 \text{ pF} \times 1 \text{ V} \div 5 \mu\text{A} = 10 \mu\text{s}$$

Setting at current limit mask time

$$T_{CMK} \approx C_{CMK} \times V_{tCMK} \div I_{CMK} \\ = 0.1 \mu\text{F} \times 1.5 \text{ V} \div 25 \mu\text{A} = 6 \text{ ms}$$

Setting at current limit brake time

$$T_{CHOP} \approx C_{CHOP} \times V_{tCHOP} \div I_{CHOP} \\ = 50 \text{ pF} \times 1 \text{ V} \div 5 \mu\text{A} = 10 \mu\text{s}$$



* The external part constant is a reference value.

LV8762T

ON Semiconductor and the ON Semiconductor logo are trademarks of Semiconductor Components Industries, LLC dba ON Semiconductor or its subsidiaries in the United States and/or other countries. ON Semiconductor owns the rights to a number of patents, trademarks, copyrights, trade secrets, and other intellectual property. A listing of ON Semiconductor's product/patent coverage may be accessed at www.onsemi.com/site/pdf/Patent-Marking.pdf. ON Semiconductor reserves the right to make changes without further notice to any products herein. ON Semiconductor makes no warranty, representation or guarantee regarding the suitability of its products for any particular purpose, nor does ON Semiconductor assume any liability arising out of the application or use of any product or circuit, and specifically disclaims any and all liability, including without limitation special, consequential or incidental damages. Buyer is responsible for its products and applications using ON Semiconductor products, including compliance with all laws, regulations and safety requirements or standards, regardless of any support or applications information provided by ON Semiconductor. "Typical" parameters which may be provided in ON Semiconductor data sheets and/or specifications can and do vary in different applications and actual performance may vary over time. All operating parameters, including "Typicals" must be validated for each customer application by customer's technical experts. ON Semiconductor does not convey any license under its patent rights nor the rights of others. ON Semiconductor products are not designed, intended, or authorized for use as a critical component in life support systems or any FDA Class 3 medical devices or medical devices with a same or similar classification in a foreign jurisdiction or any devices intended for implantation in the human body. Should Buyer purchase or use ON Semiconductor products for any such unintended or unauthorized application, Buyer shall indemnify and hold ON Semiconductor and its officers, employees, subsidiaries, affiliates, and distributors harmless against all claims, costs, damages, and expenses, and reasonable attorney fees arising out of, directly or indirectly, any claim of personal injury or death associated with such unintended or unauthorized use, even if such claim alleges that ON Semiconductor was negligent regarding the design or manufacture of the part. ON Semiconductor is an Equal Opportunity/Affirmative Action Employer. This literature is subject to all applicable copyright laws and is not for resale in any manner.

Looking for pricing, stock, or lifecycle information?

Click below to explore more details on WIN SOURCE:

-  [View LV8762T-MPB-H on WIN SOURCE](#)
-  [ON Semiconductor](#) Information

Optimize Your Supply Chain with WIN SOURCE Solutions

-  Global Sourcing Solution
-  Obsolete Management
-  Cost Control Management
-  Shortage Management
-  Alternative Solution
-  Excess Inventory Management