



**THE DATASHEET OF  
LTC6410IUD-6#TRPBF**



# Low Distortion, Low Noise Differential IF Amplifier with Configurable Input Impedance

## FEATURES

- **1.4GHz –3dB Bandwidth**
- **Fixed Voltage Gain of 6dB (50Ω System)**
- **Configurable Input Impedance Allows:**
  - Simple Interface to Active Mixers
  - Improved Noise Performance
- **Wide 2.8V to 5.25V Supply Range**
- **Low Distortion:**
  - 36dBm OIP3 (70MHz)
  - 33dBm OIP3 (140MHz)
  - 31dBm OIP3 (300MHz)
- **Low Noise:**
  - 11dB NF (50Ω Z<sub>IN</sub>)
  - 8dB NF (200Ω Z<sub>IN</sub>)
- **Differential Inputs and Outputs**
- **Self-Biasing Inputs/Outputs**
- **Shutdown Mode**
- **Minimal Support Circuitry Required**
- **16-Lead 3mm × 3mm × 0.8mm QFN Package**

## DESCRIPTION

The LTC®6410-6 is a low distortion, low noise differential IF amplifier with configurable input impedance designed for use in applications from DC to 1.4GHz. The LTC6410-6 has 6dB of voltage gain. The LTC6410-6 is an excellent choice for interfacing active mixers to SAW filters. It features an active input termination that allows a customized input impedance for an optimum interface to differential active mixers. This feature provides additional power gain because of the impedance conversion and improved noise performance when compared to traditional 50Ω interface circuits. The LTC6410-6 drives a differential 50Ω load directly with low distortion, which is suitable for driving SAW filters and other 50Ω signal chain blocks.

The LTC6410-6 operates on 3V or 5V supplies. It comes in a compact 16-lead 3mm × 3mm QFN package and operates over a –40°C to 85°C temperature range.

LT, LT, LTC and LTM are registered trademarks of Linear Technology Corporation. All other trademarks are the property of their respective owners.

## APPLICATIONS

- **Post-Mixer Gain Block**
- **SAW Filter Interface/Buffering**
- **Differential IF Signal Chain Gain Block**
- **Differential Line Driver/Receiver**

## TYPICAL APPLICATION

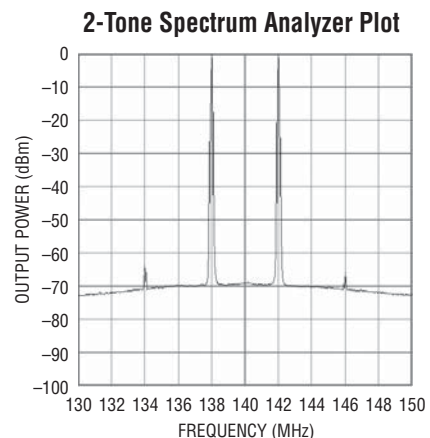
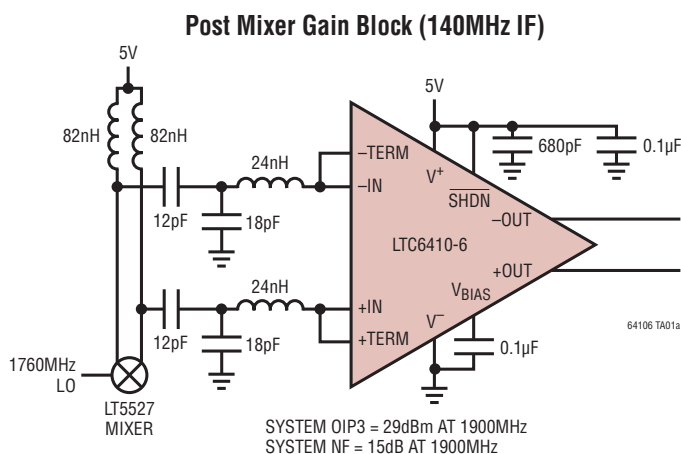

64106 TA01b

64106fa

## ABSOLUTE MAXIMUM RATINGS

(Note 1)

Total Supply Voltage ( $V^+$ to $V^-$ ) .....	5.5V
Amplifier Input Current (DC)	
(+IN, -IN, +TERM, -TERM) .....	$\pm 10\text{mA}$
Amplifier Input Power (AC)	
(+IN, -IN, +TERM, -TERM) .....	18dBm
Input Current ( $V_{\text{BIAS}}$ , SHDN) .....	$\pm 10\text{mA}$
Output Current (+OUT, -OUT) .....	$\pm 50\text{mA}$
Operating Temperature Range (Note 2)....	$-40^\circ\text{C}$ to $85^\circ\text{C}$
Specified Temperature Range (Note 3) ....	$-40^\circ\text{C}$ to $85^\circ\text{C}$
Storage Temperature Range.....	$-65^\circ\text{C}$ to $150^\circ\text{C}$
Junction Temperature .....	$150^\circ\text{C}$
Lead Temperature (Soldering, 10 sec) .....	$300^\circ\text{C}$

## PIN CONFIGURATION

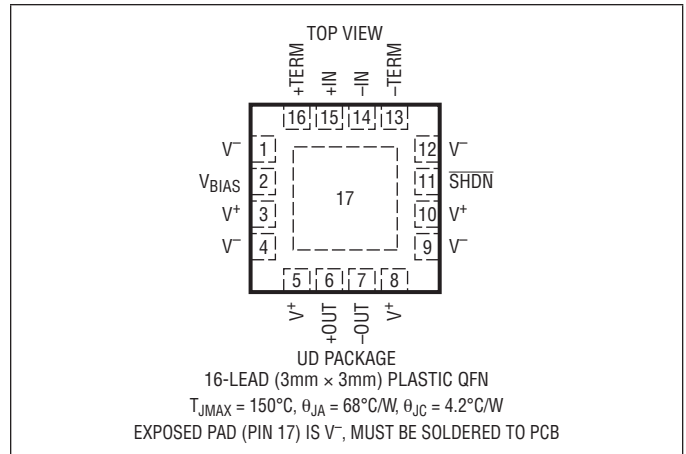

## ORDER INFORMATION

LEAD FREE FINISH	TAPE AND REEL	PART MARKING*	PACKAGE DESCRIPTION	TEMPERATURE RANGE (Notes 2, 3)
LTC6410CUD-6#PBF	LTC6410CUD-6#TRPBF	LDBG	16-Lead (3mm x 3mm) Plastic QFN	$-40^\circ\text{C}$ to $85^\circ\text{C}$
LTC6410IUD-6#PBF	LTC6410IUD-6#TRPBF	LDBG	16-Lead (3mm x 3mm) Plastic QFN	$-40^\circ\text{C}$ to $85^\circ\text{C}$

Consult LTC Marketing for parts specified with wider operating temperature ranges. \*The temperature grade is identified by a label on the shipping container. Consult LTC Marketing for information on non-standard lead based finish parts.

For more information on lead free part marking, go to: <http://www.linear.com/leadfree/>

For more information on tape and reel specifications, go to: <http://www.linear.com/tapeandreeel/>

### 3V DC ELECTRICAL CHARACTERISTICS

The ● denotes the specifications which apply over the full operating temperature range, otherwise specifications are at  $T_A = 25^\circ\text{C}$ .  $V^+ = 3\text{V}$ ,  $V^- = 0\text{V}$ , SHDN = 2V, +IN is shorted to +TERM, -IN is shorted to -TERM,  $V_{\text{BIAS}} = 1.5\text{V}$ , +IN = -IN = 1.5V, input source resistance ( $R_S$ ) is  $25\Omega$  on each input ( $50\Omega$  differential),  $R_L = 50\Omega$  from +OUT to -OUT, unless otherwise noted.  $V_{\text{BIAS}}$  is defined as the voltage on the  $V_{\text{BIAS}}$  pin.  $V_{\text{OUTCM}}$  is defined as  $(+OUT + -OUT)/2$ .  $V_{\text{INCM}}$  is defined as  $(+IN + -IN)/2$ .  $V_{\text{INDIFF}}$  is defined as  $(+IN - -IN)$ .  $V_{\text{OUTDIFF}}$  is defined as  $(+OUT - -OUT)$ . See DC test circuit schematic.

SYMBOL	PARAMETER	CONDITIONS	MIN	TYP	MAX	UNITS	
$G_{\text{DIFF}}$	Differential Gain (Low Frequency S21)	$V_{\text{INDIFF}} = \pm 0.2\text{V}$	●	5.0	6.0	6.7	dB
				4.7		7.0	dB
$TC_{G_{\text{DIFF}}}$	Differential Gain Temperature Coefficient		●	0.003		dB/ $^\circ\text{C}$	
$V_{\text{SWINGDIFF}}$	Differential Output Voltage Swing	$V_{\text{OUTDIFF}}, V_{\text{INDIFF}} = \pm 2\text{V}$	●	2.2	2.8	$V_{\text{P-P}}$ $V_{\text{P-P}}$	
$V_{\text{SWINGMIN}}$	Output Swing Low	Single-Ended +OUT, -OUT, $V_{\text{INDIFF}} = \pm 2\text{V}$	●		0.7	0.9	V
						1.0	V
$V_{\text{SWINGMAX}}$	Output Swing High	Single-Ended +OUT, -OUT, $V_{\text{INDIFF}} = \pm 2\text{V}$	●	1.9	2.1		V
				1.8			V
$I_{\text{OUT}}$	Output Current Drive	Short +OUT to -OUT, $V_{\text{INDIFF}} = \pm 2\text{V}$ (Note 4)	●	$\pm 38$	$\pm 42$		mA
				$\pm 36$			mA
$V_{\text{OS}}$	Input Offset Voltage		●	-2.0	0.4	2.0	mV
				-3.0		3.0	mV

**3V DC ELECTRICAL CHARACTERISTICS** The ● denotes the specifications which apply over the full operating temperature range, otherwise specifications are at  $T_A = 25^\circ\text{C}$ .  $V^+ = 3\text{V}$ ,  $V^- = 0\text{V}$ ,  $\text{SHDN} = 2\text{V}$ , +IN is shorted to +TERM, -IN is shorted to -TERM,  $V_{\text{BIAS}} = 1.5\text{V}$ , +IN = -IN = 1.5V, input source resistance ( $R_S$ ) is  $25\Omega$  on each input ( $50\Omega$  differential),  $R_L = 50\Omega$  from +OUT to -OUT, unless otherwise noted.  $V_{\text{BIAS}}$  is defined as the voltage on the  $V_{\text{BIAS}}$  pin.  $V_{\text{OUTCM}}$  is defined as  $(+\text{OUT} + -\text{OUT})/2$ .  $V_{\text{INCM}}$  is defined as  $(+\text{IN} + -\text{IN})/2$ .  $V_{\text{INDIFF}}$  is defined as  $(+\text{IN} - -\text{IN})$ .  $V_{\text{OUTDIFF}}$  is defined as  $(+\text{OUT} - -\text{OUT})$ . See DC test circuit schematic.

SYMBOL	PARAMETER	CONDITIONS	MIN	TYP	MAX	UNITS
TC $V_{\text{OS}}$	Input Offset Voltage Drift		●	-0.3		$\mu\text{V}/^\circ\text{C}$
$V_{\text{OSINCM}}$	Common Mode Offset Voltage	$V_{\text{OUTCM}} - V_{\text{INCM}}$	●	-40 -50	13 40 50	mV mV
$A_V$	Internal Voltage Gain			2.7		V/V
$I_{\text{VRMIN}}$	Input Common Mode Voltage Range, (Min)		●		1.0	V
$I_{\text{VRMAX}}$	Input Common Mode Voltage Range, (Max)		●	2.0		V
$R_{\text{INDIFF}}$	Differential Input Resistance	$V_{\text{INDIFF}} = \pm 100\text{mV}$ (Note 4)	●	40 30	58 80 100	$\Omega$ $\Omega$
$X_{\text{INDIFF}}$	Differential Input Reactance	$f = 100\text{MHz}$		1		pF
$R_{\text{INCM}}$	Input Common Mode Resistance			1000		$\Omega$
CMRR	Common Mode Rejection Ratio	$V_{\text{BIAS}} = 1.5\text{V}$ , +IN = -IN = 1V to 2V, ( $\Delta V_{\text{OUTDIFF}}/\text{Gain}$ )	●	45	60	dB
$R_{\text{ODIFF}}$	Differential Output Resistance	$V_{\text{OUTDIFF}} = \pm 100\text{mV}$ (Note 4)	●	17 13	22 47	$\Omega$ $\Omega$
$X_{\text{OUTDIFF}}$	Differential Output Reactance	$f = 100\text{MHz}$		10		nH
$R_{\text{OUTCM}}$	Common Mode Output Resistance			7		$\Omega$

#### Bias Voltage Control ( $V_{\text{BIAS}}$ Pin)

$G_{\text{CM}}$	Common Mode Gain	$V_{\text{BIAS}} = 1.2\text{V}$ to $1.8\text{V}$ (+IN and -IN floating), $\Delta V_{\text{OUTCM}}/(0.6\text{V})$	●	0.7 0.6	0.86 1.0	1.0 1.0	V/V V/V
$V_{\text{OCMMIN}}$	Output Common Mode Voltage Adjustment Range, (Min)		●		1.0	1.2	V
$V_{\text{OCMMAX}}$	Output Common Mode Voltage Adjustment Range, (Max)		●	1.8	2.0		V
$V_{\text{OSCM}}$	Output Common Mode Offset Voltage	$V_{\text{OUTCM}} - V_{\text{BIAS}}$	●	-200 -400	100	300 400	mV mV
$R_{\text{VOCM}}$	$V_{\text{BIAS}}$ Input Resistance		●	2.4 2.0	3.0	3.6 4.0	k $\Omega$ k $\Omega$
$C_{\text{VBIAS}}$	$V_{\text{BIAS}}$ Input Capacitance				3		pF

#### SHDN Pin

$V_{\text{IL}}$	SHDN Input Low Voltage		●	0.8	1.0		V
$V_{\text{IH}}$	SHDN Input High Voltage		●		1.8	2	V
$I_{\text{IL}}$	SHDN Input Low Current	SHDN = 0.8V	●	-200	-85	0	$\mu\text{A}$
$I_{\text{IH}}$	SHDN Input High Current	SHDN = 2V	●	-150	-30	0	$\mu\text{A}$

#### Power Supply

$V_S$	Operating Range		●	2.8		5.25	V
$I_S$	Supply Current		●		104	130 140	mA mA
$I_{\text{SSHDN}}$	Supply Current in Shutdown	SHDN = 0.8V	●		3	5	mA
PSRR	Power Supply Rejection Ratio	$V^+ = 2.8\text{V}$ to $5.25\text{V}$ , $V_{\text{BIAS}} = +\text{IN} = -\text{IN} = V^+/2$	●	73	100		dB

**5V DC ELECTRICAL CHARACTERISTICS** The ● denotes the specifications which apply over the full operating temperature range, otherwise specifications are at  $T_A = 25^\circ\text{C}$ .  $V^+ = 5\text{V}$ ,  $V^- = 0\text{V}$ ,  $\overline{\text{SHDN}} = 3\text{V}$ , +IN is shorted to +TERM, -IN is shorted to -TERM,  $V_{\text{INCM}} = V_{\text{BIAS}} = 2.5\text{V}$ , +IN = -IN = 2.5V, input source resistance ( $R_S$ ) is  $25\Omega$  on each input ( $50\Omega$  differential),  $R_L = 50\Omega$  from +OUT to -OUT, unless otherwise noted.  $V_{\text{BIAS}}$  is defined as the voltage on the  $V_{\text{BIAS}}$  pin.  $V_{\text{OUTCM}}$  is defined as  $(+\text{OUT} + -\text{OUT})/2$ .  $V_{\text{INCM}}$  is defined as  $(+\text{IN} + -\text{IN})/2$ .  $V_{\text{INDIFF}}$  is defined as  $(+\text{IN} - -\text{IN})$ .  $V_{\text{OUTDIFF}}$  is defined as  $(+\text{OUT} - -\text{OUT})$ . See DC test circuit schematic.

SYMBOL	PARAMETER	CONDITIONS	MIN	TYP	MAX	UNITS
$G_{\text{DIFF}}$	Differential Gain (Low Frequency S21)	$V_{\text{IN}} = \pm 0.2\text{V}$	● 5 4.7	6.1	6.7 7.0	dB dB
$V_{\text{SWINGDIFF}}$	Differential Output Voltage Swing	$V_{\text{OUTDIFF}}, V_{\text{IN}} = \pm 4\text{V}$	● 4.1 3.5	4.8		$V_{\text{P-P}}$ $V_{\text{P-P}}$
$V_{\text{SWINGMIN}}$	Output Swing Low	Single-Ended +OUT, -OUT, $V_{\text{IN}} = \pm 4\text{V}$	●	1.1	1.4 1.6	V V
$V_{\text{SWINGMAX}}$	Output Swing High	Single-Ended +OUT, -OUT, $V_{\text{IN}} = \pm 4\text{V}$	● 3.2 3.0	3.5		V V
$I_S$	Supply Current		●	125	150 160	mA mA

### SHDN Pin

$V_{\text{IL}}$	SHDN Input Low Voltage		● 1.8	2.0		V
$V_{\text{IH}}$	SHDN Input High Voltage		●	2.8	3	V
$I_{\text{IL}}$	SHDN Input Low Current	SHDN = 1.8V	● -300	-110	0	$\mu\text{A}$
$I_{\text{IH}}$	SHDN Input High Current	SHDN = 3V	● -200	-60	0	$\mu\text{A}$

**AC ELECTRICAL CHARACTERISTICS** The ● denotes the specifications which apply over the full operating temperature range, otherwise specifications are at  $T_A = 25^\circ\text{C}$ .  $V^+ = 3\text{V}$ ,  $V^- = 0\text{V}$ ,  $\overline{\text{SHDN}} = 2\text{V}$ , +IN is shorted to +TERM, -IN is shorted to -TERM,  $V_{\text{INCM}} = V_{\text{BIAS}} = 1.5\text{V}$ , input source resistance ( $R_S$ ) is  $25\Omega$  on each input ( $50\Omega$  differential),  $R_L = 50\Omega$  from +OUT to -OUT, +IN and -IN are AC-coupled, unless otherwise noted.  $V_{\text{BIAS}}$  is defined as the voltage on the  $V_{\text{BIAS}}$  pin.  $V_{\text{OUTCM}}$  is defined as  $(+\text{OUT} + -\text{OUT})/2$ .  $V_{\text{INCM}}$  is defined as  $(+\text{IN} + -\text{IN})/2$ .  $V_{\text{INDIFF}}$  is defined as  $(+\text{IN} - -\text{IN})$ .  $V_{\text{OUTDIFF}}$  is defined as  $(+\text{OUT} - -\text{OUT})$ .

SYMBOL	PARAMETER	CONDITIONS	MIN	TYP	MAX	UNITS
-3dBBW	-3dB Bandwidth	$V_{\text{INDIFF}} = -10\text{dBm}$	1	1.4		GHz
0.1dBBW	Bandwidth for 0.1dB Flatness	$V_{\text{INDIFF}} = -10\text{dBm}$		150		MHz
0.5dBBW	Bandwidth for 0.5dB Flatness	$V_{\text{INDIFF}} = -10\text{dBm}$		300		MHz
SR	Slew Rate			1.5		V/ns
$t_s$	1% Settling Time	1% Settling for a $1V_{\text{P-P}}$ $V_{\text{OUTDIFF}}$ Step		3		ns
$t_{\text{ON}}$	Turn-On Time	SHDN = 0V to 3V, +OUT and -OUT Within 10% of Final Values		30		ns
$t_{\text{OFF}}$	Turn-Off Time	SHDN = 3V to 0V, +OUT and -OUT Within 10% of Final Values		30		ns

### Common Mode Voltage Control ( $V_{\text{BIAS}}$ Pin)

-3dBBWCM	Common Mode Small-Signal -3dB Bandwidth	$0.2V_{\text{P-P}}$ at $V_{\text{BIAS}}$ , Measured $V_{\text{OUTCM}}$		1		GHz
SRCM	Common Mode Slew Rate			100		V/ $\mu\text{s}$

### Noise/Harmonic Performance Input/Output Characteristics

#### 10MHz Signal

HD2	Second Harmonic Distortion	$V_{\text{OUTDIFF}} = 0\text{dBm}$		-85		dBc
HD3	Third Harmonic Distortion	$V_{\text{OUTDIFF}} = 0\text{dBm}$		-71		dBc

**AC ELECTRICAL CHARACTERISTICS** The ● denotes the specifications which apply over the full operating temperature range, otherwise specifications are at  $T_A = 25^\circ\text{C}$ .  $V^+ = 3\text{V}$ ,  $V^- = 0\text{V}$ ,  $\text{SHDN} = 2\text{V}$ ,  $+\text{IN}$  is shorted to  $+\text{TERM}$ ,  $-\text{IN}$  is shorted to  $-\text{TERM}$ ,  $V_{\text{INCM}} = V_{\text{BIAS}} = 1.5\text{V}$ , input source resistance ( $R_S$ ) is  $25\Omega$  on each input ( $50\Omega$  differential),  $R_L = 50\Omega$  from  $+\text{OUT}$  to  $-\text{OUT}$ ,  $+\text{IN}$  and  $-\text{IN}$  are AC-coupled, unless otherwise noted.  $V_{\text{BIAS}}$  is defined as the voltage on the  $V_{\text{BIAS}}$  pin.  $V_{\text{OUTCM}}$  is defined as  $(+\text{OUT} + -\text{OUT})/2$ .  $V_{\text{INCM}}$  is defined as  $(+\text{IN} + -\text{IN})/2$ .  $V_{\text{INDIFF}}$  is defined as  $(+\text{IN} - -\text{IN})$ .  $V_{\text{OUTDIFF}}$  is defined as  $(+\text{OUT} - -\text{OUT})$ .

SYMBOL	PARAMETER	CONDITIONS	MIN	TYP	MAX	UNITS
IM3	Third Order Intermodulated Distortion	$F1 = 9.5\text{MHz}$ , $F2 = 10.5\text{MHz}$ , $V_{\text{OUTDIFF}} = 0\text{dBm/Tone}$		-72		dBc
		$F1 = 9.5\text{MHz}$ , $F2 = 10.5\text{MHz}$ , $V_{\text{OUTDIFF}} = -5\text{dBm/Tone}$		-81		dBc
		$F1 = 9.5\text{MHz}$ , $F2 = 10.5\text{MHz}$ , $V_{\text{OUTDIFF}} = 0\text{dBm/Tone}$ , $V_{\text{CC}} = 5\text{V}$ , $V_{\text{BIAS}} = 2.5\text{V}$ , $\text{SHDN} = 3\text{V}$		-66		dBc
OIP3	Output Third-Order Intercept	$F1 = 9.5\text{MHz}$ , $F2 = 10.5\text{MHz}$ , $V_{\text{OUTDIFF}} = 0\text{dBm/Tone}$		36		dBm
		$F1 = 9.5\text{MHz}$ , $F2 = 10.5\text{MHz}$ , $V_{\text{OUTDIFF}} = -5\text{dBm/Tone}$		36		dBm
		$F1 = 9.5\text{MHz}$ , $F2 = 10.5\text{MHz}$ , $V_{\text{OUTDIFF}} = 0\text{dBm/Tone}$ , $V_{\text{CC}} = 5\text{V}$ , $V_{\text{BIAS}} = 2.5\text{V}$ , $\text{SHDN} = 3\text{V}$		33		dBm
P1dB	Output 1dB Compression Point			12.8		dBm
NF	Noise Figure	$Z_{\text{IN}} = 50\Omega$ (Note 5)		11		dB
		$Z_{\text{IN}} = 200\Omega$		8		dB

**70MHz Signal**

HD2	Second Harmonic Distortion	$V_{\text{OUTDIFF}} = 0\text{dBm}$		-85		dBc
HD3	Third Harmonic Distortion	$V_{\text{OUTDIFF}} = 0\text{dBm}$		-69		dBc
IM3	Third Order Intermodulated Distortion	$F1 = 69.5\text{MHz}$ , $F2 = 70.5\text{MHz}$ , $V_{\text{OUTDIFF}} = 0\text{dBm/Tone}$		-72		dBc
		$F1 = 69.5\text{MHz}$ , $F2 = 70.5\text{MHz}$ , $V_{\text{OUTDIFF}} = -5\text{dBm/Tone}$		-79		dBc
		$F1 = 69.5\text{MHz}$ , $F2 = 70.5\text{MHz}$ , $V_{\text{OUTDIFF}} = 0\text{dBm/Tone}$ , $V_{\text{CC}} = 5\text{V}$ , $V_{\text{BIAS}} = 2.5\text{V}$ , $\text{SHDN} = 3\text{V}$		-72		dBc
OIP3	Output Third-Order Intercept	$F1 = 69.5\text{MHz}$ , $F2 = 70.5\text{MHz}$ , $V_{\text{OUTDIFF}} = 0\text{dBm/Tone}$		36		dBm
		$F1 = 69.5\text{MHz}$ , $F2 = 70.5\text{MHz}$ , $V_{\text{OUTDIFF}} = -5\text{dBm/Tone}$		35		dBm
		$F1 = 69.5\text{MHz}$ , $F2 = 70.5\text{MHz}$ , $V_{\text{OUTDIFF}} = 0\text{dBm/Tone}$ , $V_{\text{CC}} = 5\text{V}$ , $V_{\text{BIAS}} = 2.5\text{V}$ , $\text{SHDN} = 3\text{V}$		36		dBm
P1dB	Output 1dB Compression Point			12.8		dBm
NF	Noise Figure	$Z_{\text{IN}} = 50\Omega$ (Note 5)		11		dB
		$Z_{\text{IN}} = 200\Omega$		8		dB

**140MHz Signal**

HD2	Second Harmonic Distortion	$V_{\text{OUTDIFF}} = 0\text{dBm}$		-80		dBc
HD3	Third Harmonic Distortion	$V_{\text{OUTDIFF}} = 0\text{dBm}$		-62		dBc
IM3	Third Order Intermodulated Distortion	$F1 = 139.5\text{MHz}$ , $F2 = 140.5\text{MHz}$ , $V_{\text{OUTDIFF}} = 0\text{dBm/Tone}$		-62		dBc
		$F1 = 139.5\text{MHz}$ , $F2 = 140.5\text{MHz}$ , $V_{\text{OUTDIFF}} = -5\text{dBm/Tone}$		-70		dBc
		$F1 = 139.5\text{MHz}$ , $F2 = 140.5\text{MHz}$ , $V_{\text{OUTDIFF}} = 0\text{dBm/Tone}$ , $V_{\text{CC}} = 5\text{V}$ , $V_{\text{BIAS}} = 2.5\text{V}$ , $\text{SHDN} = 3\text{V}$		-66		dBc
		$F1 = 130\text{MHz}$ , $F2 = 150\text{MHz}$ , $V_{\text{OUTDIFF}} = 0\text{dBm/Tone}$ , $V_{\text{CC}} = 5\text{V}$ , $V_{\text{BIAS}} = 2.5\text{V}$ , $\text{SHDN} = 3\text{V}$		-66	-56	dBc
OIP3	Output Third-Order Intercept	$F1 = 139.5\text{MHz}$ , $F2 = 140.5\text{MHz}$ , $V_{\text{OUTDIFF}} = 0\text{dBm/Tone}$		31		dBm
		$F1 = 139.5\text{MHz}$ , $F2 = 140.5\text{MHz}$ , $V_{\text{OUTDIFF}} = -5\text{dBm/Tone}$		30		dBm
		$F1 = 139.5\text{MHz}$ , $F2 = 140.5\text{MHz}$ , $V_{\text{OUTDIFF}} = 0\text{dBm/Tone}$ , $V_{\text{CC}} = 5\text{V}$ , $V_{\text{BIAS}} = 2.5\text{V}$ , $\text{SHDN} = 3\text{V}$		33		dBm
		$F1 = 130\text{MHz}$ , $F2 = 150\text{MHz}$ , $V_{\text{OUTDIFF}} = 0\text{dBm/Tone}$ , $V_{\text{CC}} = 5\text{V}$ , $V_{\text{BIAS}} = 2.5\text{V}$ , $\text{SHDN} = 3\text{V}$		28	33	dBm
P1dB	Output 1dB Compression Point			12.8		dBm

**AC ELECTRICAL CHARACTERISTICS** The ● denotes the specifications which apply over the full operating temperature range, otherwise specifications are at  $T_A = 25^\circ\text{C}$ .  $V^+ = 3\text{V}$ ,  $V^- = 0\text{V}$ ,  $\text{SHDN} = 2\text{V}$ ,  $+IN$  is shorted to  $+TERM$ ,  $-IN$  is shorted to  $-TERM$ ,  $V_{INCM} = V_{BIAS} = 1.5\text{V}$ , input source resistance ( $R_S$ ) is  $25\Omega$  on each input ( $50\Omega$  differential),  $R_L = 50\Omega$  from  $+OUT$  to  $-OUT$ ,  $+IN$  and  $-IN$  are AC-coupled, unless otherwise noted.  $V_{BIAS}$  is defined as the voltage on the  $V_{BIAS}$  pin.  $V_{OUTCM}$  is defined as  $(+OUT + -OUT)/2$ .  $V_{INCM}$  is defined as  $(+IN + -IN)/2$ .  $V_{INDIFF}$  is defined as  $(+IN - -IN)$ .  $V_{OUTDIFF}$  is defined as  $(+OUT - -OUT)$ .

SYMBOL	PARAMETER	CONDITIONS	MIN	TYP	MAX	UNITS
NF	Noise Figure	$Z_{IN} = 50\Omega$ (Note 5)		11		dB
		$Z_{IN} = 200\Omega$		7		dB

### 240MHz Signal

HD2	Second Harmonic Distortion	$V_{OUTDIFF} = 0\text{dBm}$		-66		dBc
HD3	Third Harmonic Distortion	$V_{OUTDIFF} = 0\text{dBm}$		-52		dBc
IM3	Third Order Intermodulated Distortion	$F1 = 239.5\text{MHz}$ , $F2 = 240.5\text{MHz}$ , $V_{OUTDIFF} = 0\text{dBm/Tone}$		-54		dBc
		$F1 = 239.5\text{MHz}$ , $F2 = 240.5\text{MHz}$ , $V_{OUTDIFF} = -5\text{dBm/Tone}$		-63		dBc
		$F1 = 239.5\text{MHz}$ , $F2 = 240.5\text{MHz}$ , $V_{OUTDIFF} = 0\text{dBm/Tone}$ , $V_{CC} = 5\text{V}$ , $V_{BIAS} = 2.5\text{V}$ , $\text{SHDN} = 3\text{V}$		-64		dBc
OIP3	Output Third-Order Intercept	$F1 = 239.5\text{MHz}$ , $F2 = 240.5\text{MHz}$ , $V_{OUTDIFF} = 0\text{dBm/Tone}$		27		dBm
		$F1 = 239.5\text{MHz}$ , $F2 = 240.5\text{MHz}$ , $V_{OUTDIFF} = -5\text{dBm/Tone}$		27		dBm
		$F1 = 239.5\text{MHz}$ , $F2 = 240.5\text{MHz}$ , $V_{OUTDIFF} = 0\text{dBm/Tone}$ , $V_{CC} = 5\text{V}$ , $V_{BIAS} = 2.5\text{V}$ , $\text{SHDN} = 3\text{V}$		32		dBm
P1dB	Output 1dB Compression Point			12.8		dBm
NF	Noise Figure	$Z_{IN} = 50\Omega$ (Note 5)		11		dB
		$Z_{IN} = 200\Omega$		8		dB

### 380MHz Signal

HD2	Second Harmonic Distortion	$V_{OUTDIFF} = 0\text{dBm}$		-57		dBc
HD3	Third Harmonic Distortion	$V_{OUTDIFF} = 0\text{dBm}$		-45		dBc
IM3	Third Order Intermodulated Distortion	$F1 = 379.5\text{MHz}$ , $F2 = 380.5\text{MHz}$ , $V_{OUTDIFF} = 0\text{dBm/Tone}$		-51		dBc
		$F1 = 379.5\text{MHz}$ , $F2 = 380.5\text{MHz}$ , $V_{OUTDIFF} = -5\text{dBm/Tone}$		-64		dBc
		$F1 = 379.5\text{MHz}$ , $F2 = 380.5\text{MHz}$ , $V_{OUTDIFF} = 0\text{dBm/Tone}$ , $V_{CC} = 5\text{V}$ , $V_{BIAS} = 2.5\text{V}$ , $\text{SHDN} = 3\text{V}$		-60		dBc
OIP3	Output Third-Order Intercept	$F1 = 379.5\text{MHz}$ , $F2 = 380.5\text{MHz}$ , $V_{OUTDIFF} = 0\text{dBm/Tone}$		26		dBm
		$F1 = 379.5\text{MHz}$ , $F2 = 380.5\text{MHz}$ , $V_{OUTDIFF} = -5\text{dBm/Tone}$		27		dBm
		$F1 = 379.5\text{MHz}$ , $F2 = 380.5\text{MHz}$ , $V_{OUTDIFF} = 0\text{dBm/Tone}$ , $V_{CC} = 5\text{V}$ , $V_{BIAS} = 2.5\text{V}$ , $\text{SHDN} = 3\text{V}$		30		dBm
P1dB	Output 1dB Compression Point			10.8		dBm
NF	Noise Figure	$Z_{IN} = 50\Omega$ (Note 5)		12		dB
		$Z_{IN} = 200\Omega$		8		dB

**Note 1:** Stresses beyond those listed under Absolute Maximum Ratings may cause permanent damage to the device. Exposure to any Absolute Maximum Rating condition for extended periods may affect device reliability and lifetime.

**Note 2:** The LTC6410C-6/LTC6410I-6 is guaranteed functional over the operating temperature range of  $-40^\circ\text{C}$  to  $85^\circ\text{C}$ .

**Note 3:** The LTC6410C-6 is guaranteed to meet specified performance from  $0^\circ\text{C}$  to  $70^\circ\text{C}$ . It is designed, characterized and expected to meet specified performance from  $-40^\circ\text{C}$  and  $85^\circ\text{C}$  but is not tested or QA

sampled at these temperatures. The LT6410I-6 is guaranteed to meet specified performance from  $-40^\circ\text{C}$  to  $85^\circ\text{C}$ .

**Note 4:** This parameter is pulse tested.

**Note 5:**  $e_n$  can be calculated from  $Z_{IN} = 50\Omega$  NF with the formula:

$$e_n = \sqrt{(10^{NF} - 1)4kT50}$$

where

k = Boltzmann's constant and  
T = absolute temperature

# TYPICAL PERFORMANCE CHARACTERISTICS

**Output Third Order Intercept vs Frequency**

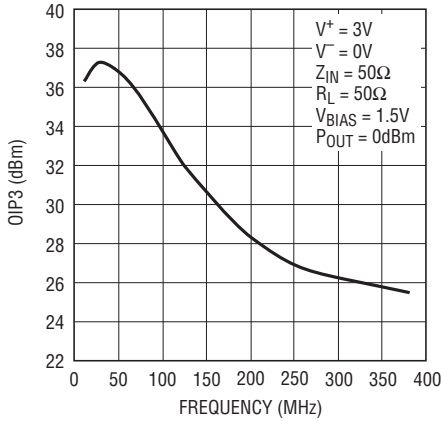

64106 G01

**Output Third Order Intercept vs Frequency ( $Z_{IN} = 200\Omega$ )**

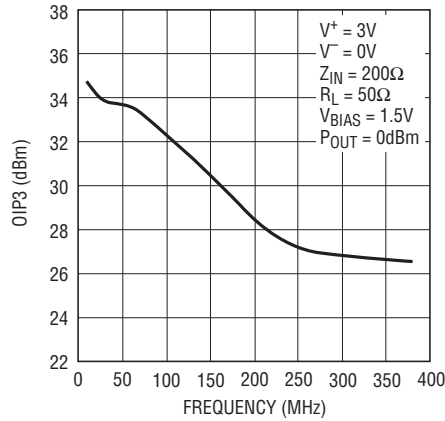

64106 G02

**Third Order Intermodulation Distortion vs Frequency vs Power**

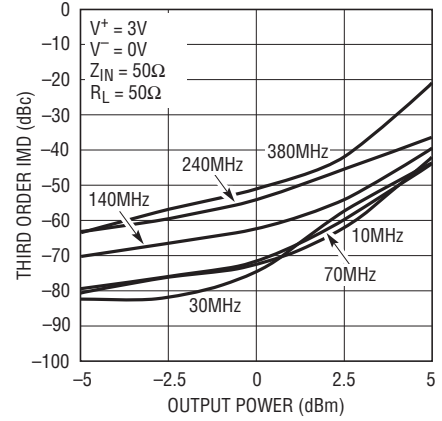

64106 G03

**Third Order Intermodulation Distortion vs Frequency vs Power ( $Z_{IN} = 200\Omega$ )**

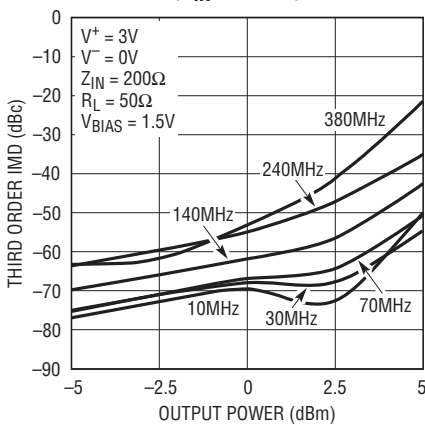

64106 G04

**Third Order Intermodulation Distortion vs Temperature**

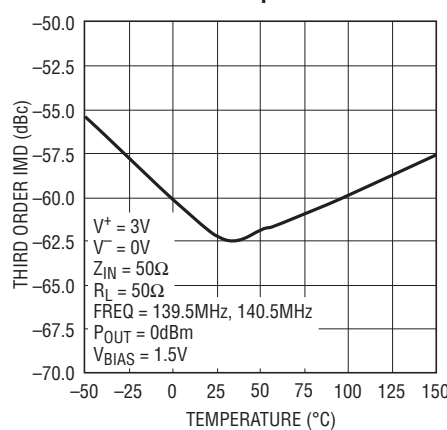

64106 G05

**Output 1dB Compression vs Frequency**

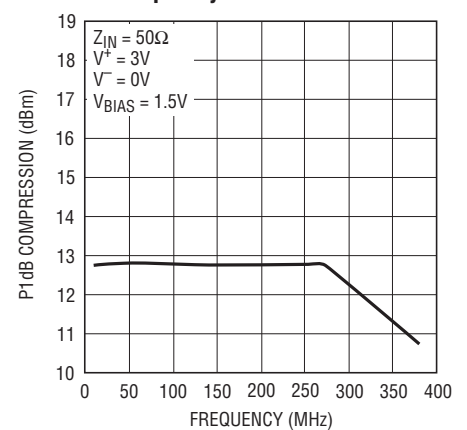

64106 G06

**Output Third Order Intercept vs Frequency**

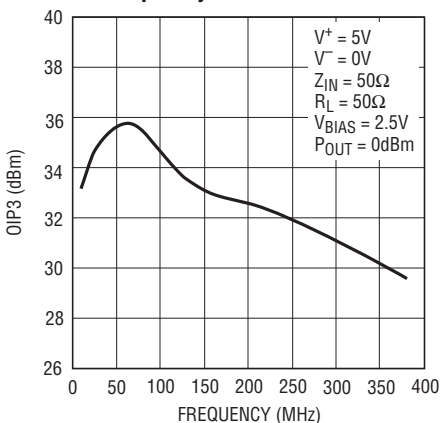

64106 G07

**Output 1dB Compression vs Frequency**

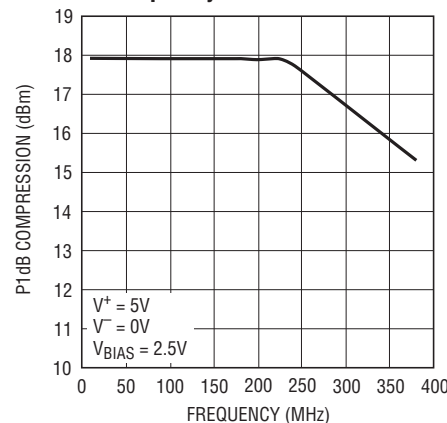

64106 G08

**Distortion vs Common Mode Voltage**

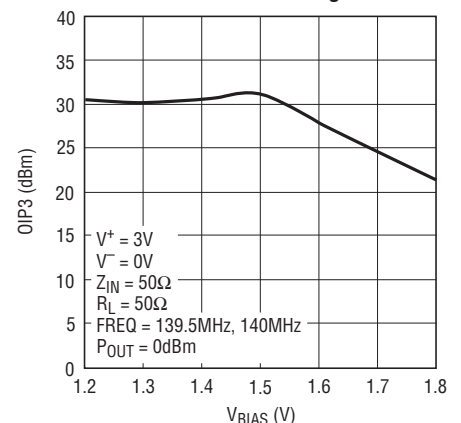

64106 G09

## TYPICAL PERFORMANCE CHARACTERISTICS

**Differential Gain vs Frequency (S21)**

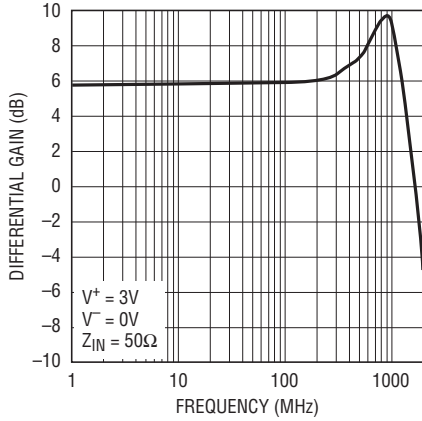

64106 G10

**Differential Input Return Loss vs Frequency (S11)**

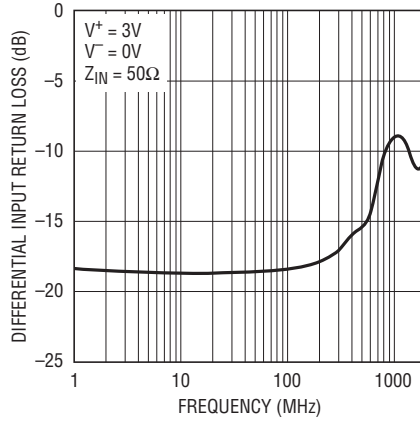

64106 G11

**Differential Output Return Loss vs Frequency (S22)**

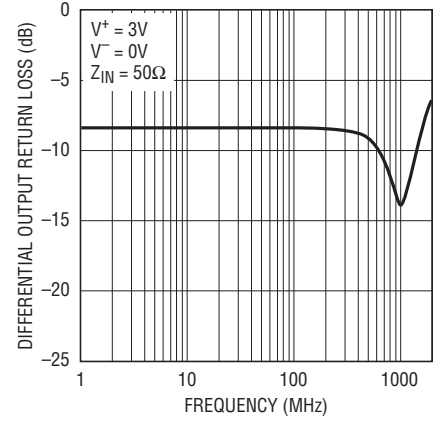

64106 G12

**Differential Reverse Isolation vs Frequency (S12)**

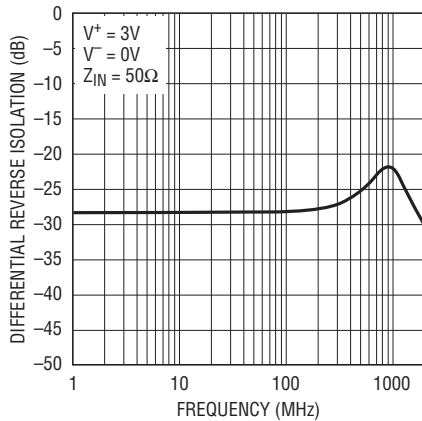

64106 G13

**Differential Input Return Loss vs Frequency on a Smith Chart (S11)**

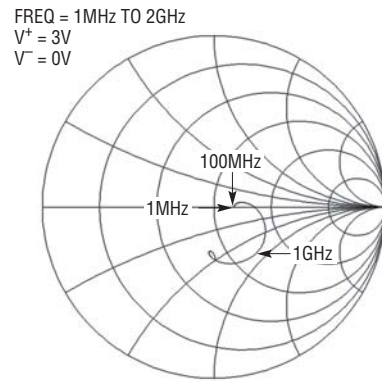

64106 G14

**Differential Output Return Loss vs Frequency on a Smith Chart (S22)**

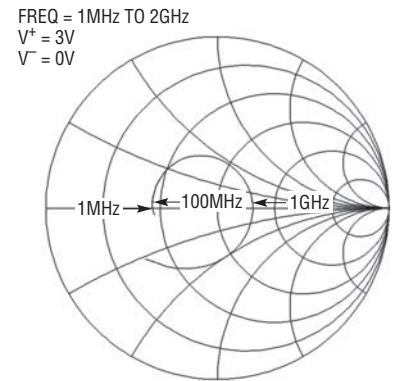

64106 G15

**Small-Signal Transient**

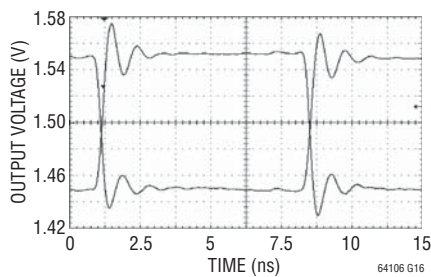

64106 G16

**Large-Signal Transient**

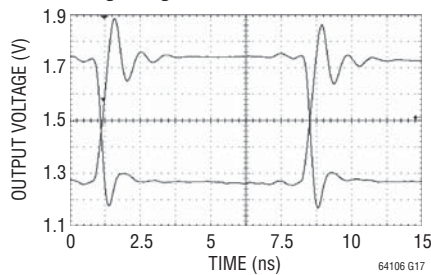

64106 G17

**Overdrive Recovery**

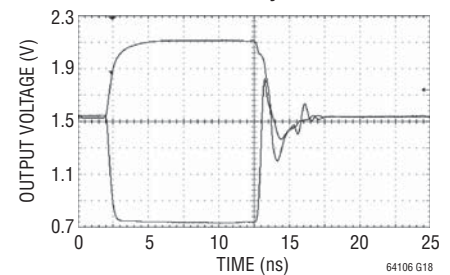

64106 G18

# TYPICAL PERFORMANCE CHARACTERISTICS

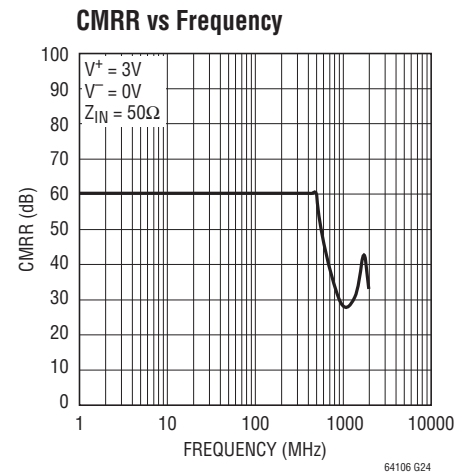
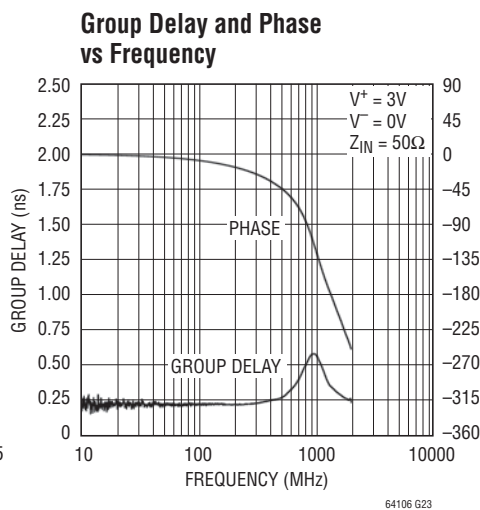
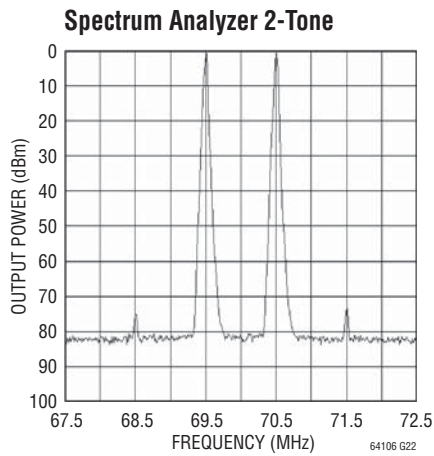
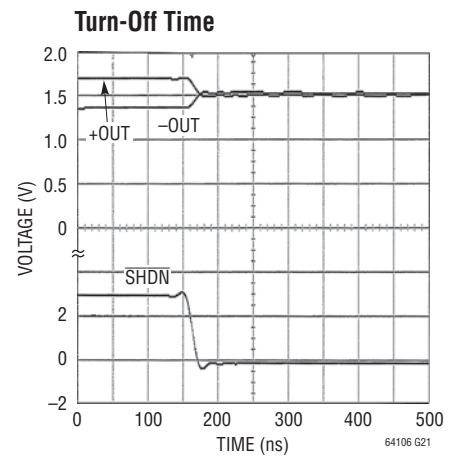
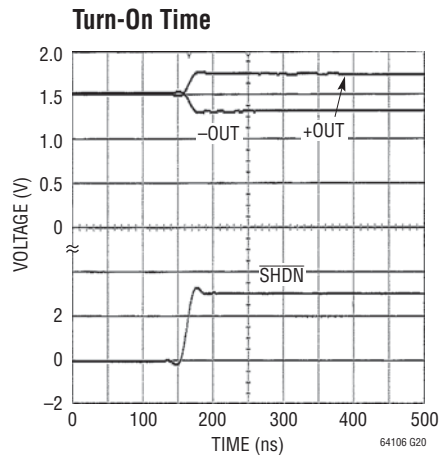
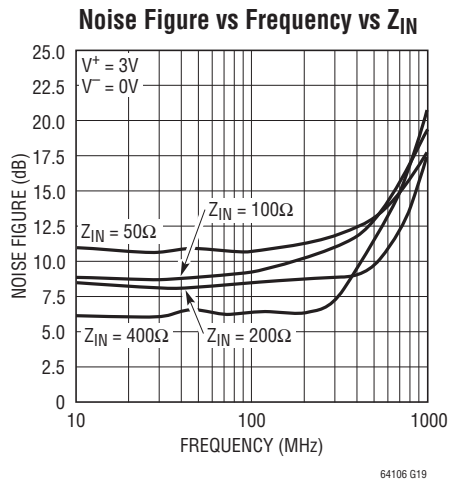

## DC TEST CIRCUIT SCHEMATIC

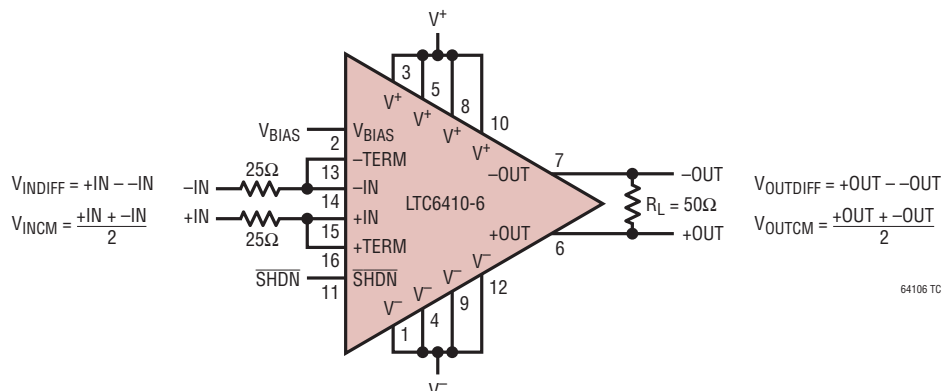



## APPLICATIONS INFORMATION

### Introduction

The LTC6410-6 is a low noise differential high speed amplifier. By default, the LTC6410-6 has 6dB voltage gain and is designed to operate with  $50\Omega$  differential input and output impedances. By changing ( $R_{EXT}$ ), alternative configurations provide input resistances of up to  $400\Omega$ , with correspondingly lower noise figure and higher power gain. The Block Diagram shows the basic circuit along with key external components while Table 1 provides configuration information. If the input is AC-coupled, the  $V_{BIAS}$  pin sets the input common mode voltage and therefore the output common mode voltage.

### Input Impedance

LTC6410-6 has been designed with very flexible input termination circuitry. By default, with the termination pins connected directly to the inputs, the input impedance is  $58\Omega$ , see the Block Diagram. Internally, there is  $110\Omega$  between each input and the opposite output ( $R_T$ ). Dividing the resistor by the internal noise gain of  $2.7 + 1 = 3.7$ ,  $29.5\Omega$  input impedance is created ( $59\Omega$  differential). In parallel with the  $2k$  common mode resistance, a total of  $58\Omega$  differential input impedance is achieved. This method of termination is used to provide lower noise figure through the use of feedback which reduces the effective noise of the termination resistor. By adding additional resistance in series with the termination pins, higher input impedances can be obtained (see Table 1). The optimum impedance for minimizing the noise figure of the LTC6410-6 is close to  $400\Omega$ . Because the amplifier is inherently a voltage amplifier, the difference between the impedance at the input and the output adds additional power gain as can be seen in Table 1. These higher impedance levels can be useful in interfacing with active mixers which can have output impedance of  $400\Omega$  and beyond.

### Input and Output Common Mode Bias

The LTC6410-6 is internally self-biased through the  $V_{BIAS}$  pin (see the Block Diagram). Therefore the LTC6410-6 can be AC-coupled with no external biasing circuitry. The

output will have approximately the same common mode voltage as the input.

In the case of a DC-coupled input connection, the input DC common mode voltage will also set the output common mode voltage. Note that a voltage divider is formed between the  $V_{BIAS}$  buffer output and the DC input source impedance.

The  $V_{BIAS}$  pin has an internal voltage divider which will self bias to approximately  $1.4V$  on a  $3V$  supply ( $0.47 \cdot V_{SUPPLY}$ ). An external capacitor of  $0.1\mu F$  to ground is recommended to bypass the pin. The resistance of the pin is  $3k$ . See Distortion vs Common Mode graph.

For increased common mode accuracy, the +TERM and -TERM pins can be AC-coupled to the inputs with capacitors ( $C_{EXT}$ ). This coupling prevents the feedback from the termination resistance from creating additional DC common mode voltage error. The  $G_{CM}$  and  $V_{OSCM}$  of the DC Electrical Characteristics table reflect the less accurate DC-coupled scenario.

The termination inputs are part of a high speed feedback loop. The physical length of the termination loop ( $R_{EXT}$  and  $C_{EXT}$ ) must be minimized to maintain stability and minimize gain peaking.

### Gain

Internally, the LTC6410-6 has a voltage gain of  $2.7V/V$ . The default source and load resistances in most of the data sheet are assumed to be  $50\Omega$  differential. Due to the input and output resistance of the LTC6410-6 being  $58\Omega$  and  $22\Omega$  respectively, the overall voltage gain in a  $50\Omega$  system is 6dB ( $2V/V$ ). Other source and load resistances will produce different gains due to the resistive dividers. Figure 1 is a system diagram for calculating gain.

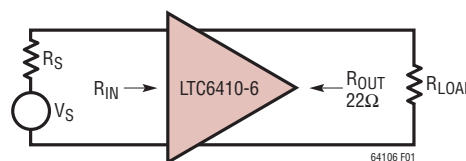

Figure 1

## APPLICATIONS INFORMATION

Therefore the differential voltage gain can be calculated as follows:

$$\text{Voltage Gain} = 2 \cdot \frac{R_{IN}}{R_{IN} + R_S} \cdot 2.7 \cdot \frac{R_L}{R_L + R_{OUT}}$$

The following is an example of the 50Ω gain calculation:

$$\begin{aligned} \text{Voltage Gain} &= 2 \cdot \frac{58}{58+50} \cdot 2.7 \cdot \frac{50}{50+22} \\ &= 2.0\text{V/V} = 6.0\text{dB} \end{aligned}$$

The part also can be used with different input impedances providing no additional voltage gain, but a higher power gain.

For example, the calculation for a 100Ω input impedance shows the effect of an impedance conversion. The voltage gain is calculated as follows:

$$\begin{aligned} \text{Voltage Gain} &= 2 \cdot \frac{83}{83+100} \cdot 2.7 \cdot \frac{50}{50+22} \\ &= 1.7\text{V/V} = 4.6\text{dB} \end{aligned}$$

However the power gain is:

$$\begin{aligned} \text{Power Gain} &= \left( 2 \cdot \frac{83}{83+100} \cdot 2.7 \cdot \frac{50}{50+22} \cdot \sqrt{2} \right)^2 \\ &= 5.8\text{mW/mW} = 7.6\text{dB} \end{aligned}$$

### Output Impedance

The LTC6410-6 is designed to drive a differential load of 50Ω with a total differential output resistance of 22Ω. While the LTC6410-6 can source and sink approximately 50mA, large DC output current should be avoided. To test the part on traditional 50Ω test equipment, AC coupling or balun transformers (or both) may be necessary at the input and output.

### Supply Rails

Inductance in the supply path can severely effect the performance of the LTC6410-6. Therefore it is recommended that low inductance bypass capacitors are installed very close to the part. 680pF and 0.1μF sized capacitors are recommended. Additionally, the exposed pad of the part must be connected to V<sup>-</sup> for low inductance and low thermal resistance. Failure to provide a low impedance supply at high frequencies can cause oscillations and increased distortion.

### SHDN

The SHDN pin self-biases to V<sup>+</sup> through a 30k resistor. The pin must be pulled below 0.8V in order to shut down the part.

### Applications Circuits

The graphs on the following page are examples of the four differential input resistances used on the DC1103A demo board with balun transformers for interfacing with the 50Ω single-ended measurement equipment.

**Table 1. Input Impedance**

DIFFERENTIAL SOURCE RESISTANCE (Ω) (R <sub>S</sub> )	EXTERNAL TERMINATION RESISTOR (Ω) (R <sub>EXT</sub> )	EFFECTIVE DIFFERENTIAL INPUT IMPEDANCE (Ω) (R <sub>IN</sub> )	DIFFERENTIAL LOAD RESISTANCE (Ω)	OUTPUT RESISTANCE (Ω)	POWER GAIN (dB)	VOLTAGE GAIN (SOURCE AND LOAD RESISTANCE AS STATED) (V/V)	NF AT 10MHz (dB)
50	0	58	50	22	6.0	2.0	11
100	49.9	83	50	22	7.6	1.7	9
200	249	177	50	22	10.9	1.8	7
400	750	377	50	22	14.2	1.8	6
2000	Open	2000	50	22	21.5	1.9	-

# APPLICATIONS INFORMATION

$Z_{IN} = 50\Omega$ , T1 = ETC1-1-13, T2 = ETC1-1-13

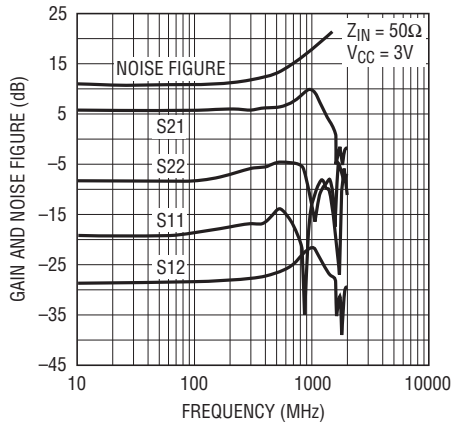
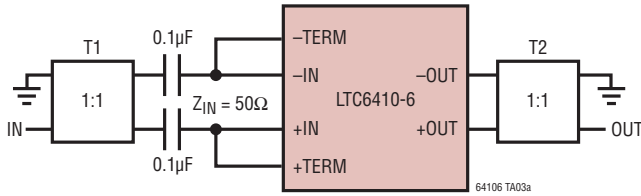

64106 TA02b

$Z_{IN} = 100\Omega$ , T1 = WBC2-1TL, T2 = ETC1-1-13

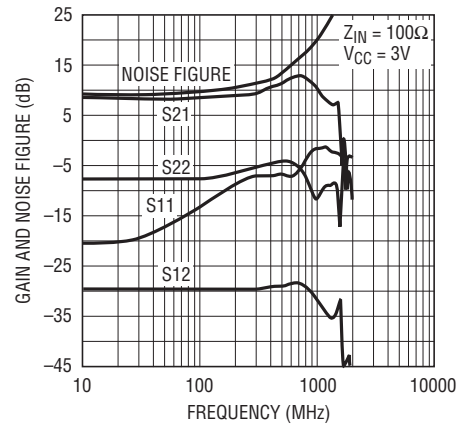
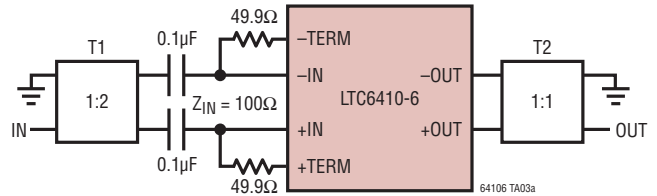

64106 TA03b

$Z_{IN} = 200\Omega$ , T1 = WBC4-14L, T2 = ETC1-1-13

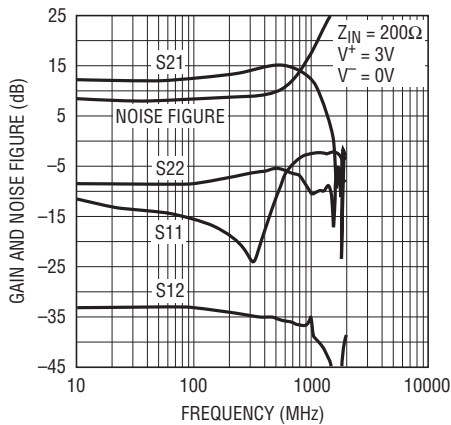
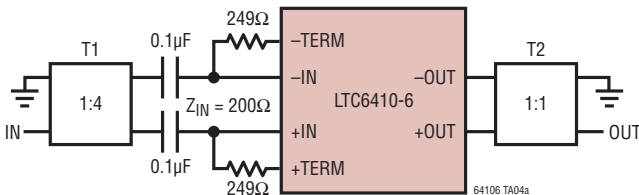

64106 TA04b

$Z_{IN} = 400\Omega$ , T1 = WBC8-1L, T2 = ETC1-1-13

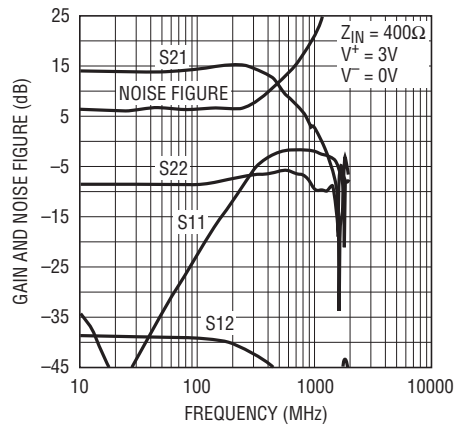
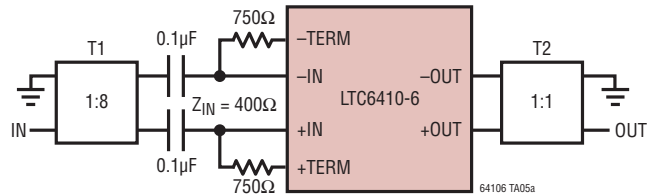

64106 TA05b

## APPLICATIONS INFORMATION

Demoboard DC1103A Top Silkscreen

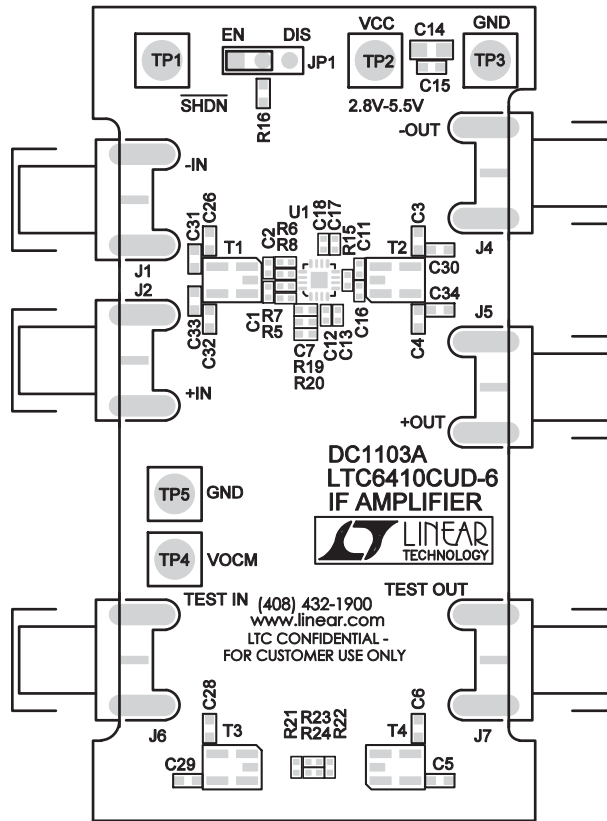

## TYPICAL APPLICATION

SAW Filter Application

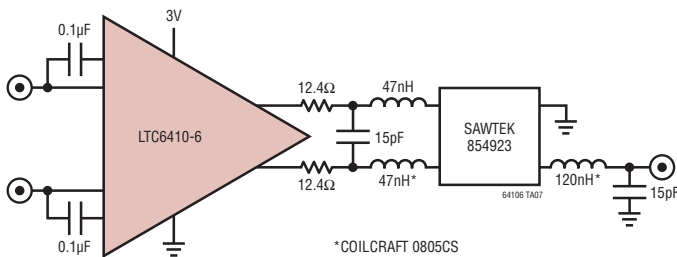

The schematic above shows a typical signal chain application with the LTC6410-6 in combination with a 140MHz center frequency 24MHz bandwidth SAW filter. Without the LTC6410-6, the attenuation of the SAW would be  $-11.5\text{dB}$ . The networks between the LTC6410-6 and the SAW filter, and after the SAW filter are for proper impedance matching.

The differential output of the LTC6410-6 allows differential driving of the SAW filter without the need for a transformer. The differential nature of the LTC6410-6 allows for ease of use in differential signal chains, and may reduce the need for transformers.

SAW Filter Application

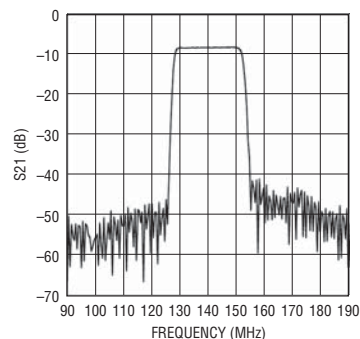

64106 TA08



## TYPICAL APPLICATION

Demoboard DC1103A Schematic

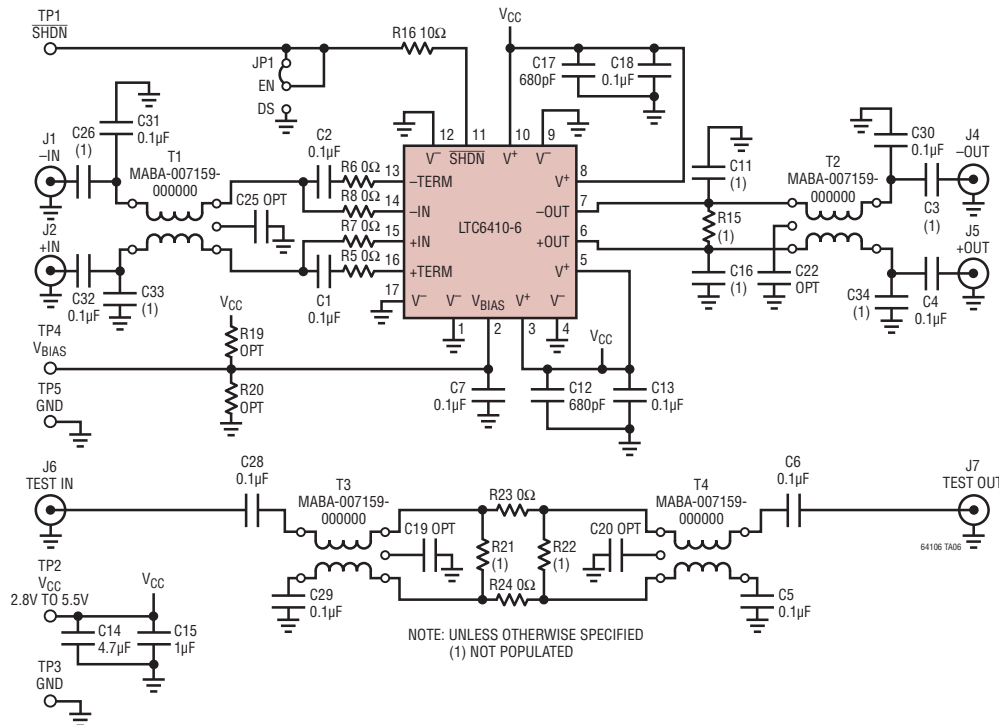

## RELATED PARTS

PART NUMBER	DESCRIPTION	COMMENTS
LT1993-2	800MHz Differential Amplifier/ADC Driver	$A_V = 2V/V$ , NF = 12.3dB, OIP3 = 38dBm at 70MHz
LT1993-4	900MHz Differential Amplifier/ADC Driver	$A_V = 4V/V$ , NF = 14.5dB, OIP3 = 40dBm at 70MHz
LT1993-10	700MHz Differential Amplifier/ADC Driver	$A_V = 10V/V$ , NF = 12.7dB, OIP3 = 40dBm at 70MHz
LT5514	Ultralow Distortion IF Amplifier/ADC Driver	Digitally Controlled Gain Output IP3 47dBm at 100MHz
LT5522	600MHz to 2.7GHz High Signal Level Downconverting Mixer	4.5V to 5.25V Supply, 25dBm IIP3 at 900MHz, NF = 12.5dB, 50Ω Single-Ended RF and LO Ports, $R_{OUT} = 400\Omega$
LT5524	Low Power, Low Distortion ADC Driver with Digitally Programmable Gain	450MHz Bandwidth, 40dBm OIP3, 4.5dB to 27dB Gain Control
LT5525	High Linearity, Low Power Downconverting Mixer	Single-Ended 50Ω RF and LO Ports, 17.6dBm IIP3 at 1900MHz, $I_{CC} = 28mA$
LT5526	High Linearity, Low Power Downconverting Mixer	3V to 5.3V Supply, 16.5dBm IIP3, 100kHz to 2GHz RF, NF = 11dB, $I_{CC} = 28mA$ , -65dBm LO-RF Leakage
LT5527	400MHz to 3.7GHz High Signal Level Downconverting Mixer	CG = 2.3dB at 1900MHz, IIP3 = 23.5dBm at 1900MHz, 440mW, $R_{OUT} = 415\Omega$
LT5557	400MHz to 3.8GHz High Signal Level Downconverting Mixer	CG = 2.9dB at 1950MHz, IIP3 = 24.7dBm at 1950MHz, 300mW, $R_{OUT} = 560\Omega$
LTC6400-20	1.8GHz Low Noise, Low Distortion ADC Driver for 300MHz IF	$A_V = 20dB$ , $Z_{IN} = 200\Omega$ , $I_{S(MAX)} = 105mA$ at 25°C
LTC6401-20	1.4GHz Low Noise, Low Distortion ADC Driver for 140MHz IF	$A_V = 20dB$ , $Z_{IN} = 200\Omega$ , $I_{S(MAX)} = 62mA$ at 25°C
LT6402-6	300MHz Differential Amplifier/ADC Driver	$A_V = 6dB$ , $e_n = 3.8nV/\sqrt{Hz}$ at 20MHz, 150mW
LT6402-12	300MHz Differential Amplifier/ADC Driver	$A_V = 12dB$ , $e_n = 2.6nV/\sqrt{Hz}$ at 20MHz, 150mW
LT6402-20	300MHz Differential Amplifier/ADC Driver	$A_V = 20dB$ , $e_n = 1.9nV/\sqrt{Hz}$ at 20MHz, 150mW
LT6411	650MHz Differential ADC Driver/Dual Selectable Gain Amplifier	3300V/ $\mu s$ Slew Rate, 16mA Current Consumption, Selectable Gain: $A_V = -1, 1, 2$

64106fa

## Looking for pricing, stock, or lifecycle information?

Click below to explore more details on WIN SOURCE:

- ⊖ [View LTC6410IUD-6#TRPBF on WIN SOURCE](#)
- ⊖ [Analog Devices Inc. Information](#)

## Optimize Your Supply Chain with WIN SOURCE Solutions

- ✓ Global Sourcing Solution
- ✓ Obsolete Management
- ✓ Cost Control Management
- ✓ Shortage Management
- ✓ Alternative Solution
- ✓ Excess Inventory Management