



**THE DATASHEET OF
LTC1690CMS8#TRPBF**



Differential Driver and Receiver Pair with Fail-Safe Receiver Output

FEATURES

- No Damage or Latchup to $\pm 15\text{kV}$ ESD (Human Body Model), IEC1000-4-2 Level 4 ($\pm 8\text{kV}$) Contact and Level 3 ($\pm 8\text{kV}$) Air Discharge
- Guaranteed High Receiver Output State for Floating, Shorted or Terminated Inputs with No Signal Present
- Drives Low Cost Residential Telephone Wires
- $I_{CC} = 600\mu\text{A}$ Max with No Load
- Single 5V Supply
- -7V to 12V Common Mode Range Permits $\pm 7\text{V}$ Ground Difference Between Devices on the Data Line
- Power-Up/Down Glitch-Free Driver Outputs Permit Live Insertion or Removal of Transceiver
- Driver Maintains High Impedance with the Power Off
- Up to 32 Transceivers on the Bus
- Pin Compatible with the SN75179 and LTC490
- Available in SO, **MSOP** and PDIP Packages

DESCRIPTION

The LTC[®]1690 is a low power receiver/driver pair that is compatible with the requirements of RS485 and RS422. The receiver offers a fail-safe feature that guarantees a high receiver output state when the inputs are left open, shorted together or terminated with no signal present. No external components are required to ensure the high receiver output state.

Separate driver output and receiver input pins allow full duplex operation. Excessive power dissipation caused by bus contention or faults is prevented by a thermal shut-down circuit which forces the driver outputs into a high impedance state.

The LTC1690 is fully specified over the commercial and industrial temperature ranges. The LTC1690 is available in 8-Pin SO, MSOP and PDIP packages.

LT, LTC and LT are registered trademarks of Linear Technology Corporation.

APPLICATIONS

- Battery-Powered RS485/RS422 Applications
- Low Power RS485/RS422 Transceiver
- Level Translator
- Line Repeater

TYPICAL APPLICATION

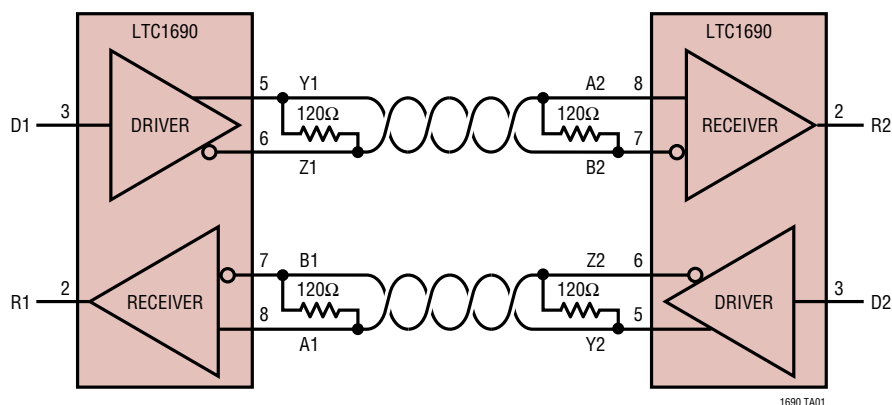

Driving a 1000 Foot STP Cable

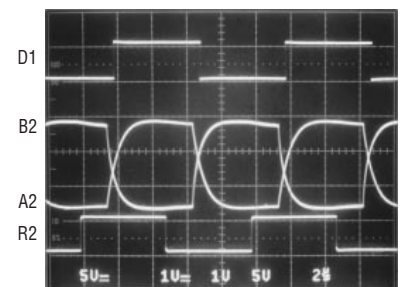

1690 TA01a

ABSOLUTE MAXIMUM RATINGS (Note 1)

Supply Voltage (V_{CC})	6.5V	Operating Temperature Range	
Driver Input Voltage	-0.3V to ($V_{CC} + 0.3V$)	LTC1690C	$0^{\circ}\text{C} \leq T_A \leq 70^{\circ}\text{C}$
Driver Output Voltages	-7V to 10V	LTC1690I	$-40^{\circ}\text{C} \leq T_A \leq 85^{\circ}\text{C}$
Receiver Input Voltages	$\pm 14V$	Storage Temperature Range	-65°C to 150°C
Receiver Output Voltage	-0.3V to ($V_{CC} + 0.3V$)	Lead Temperature (Soldering, 10 sec)	300°C
Junction Temperature	125°C		

PACKAGE/ORDER INFORMATION

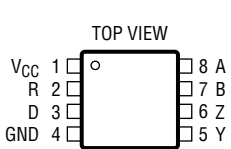
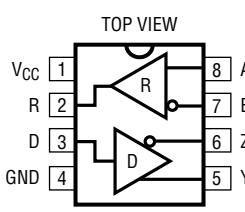
 <p>TOP VIEW</p> <p>V_{CC} 1 □ 8 A R 2 □ 7 B D 3 □ 6 Z GND 4 □ 5 Y</p> <p>MS8 PACKAGE 8-LEAD PLASTIC MSOP</p> <p>T_{JMAX} = 125°C, θ_{JA} = 200°C/W</p>	ORDER PART NUMBER	 <p>TOP VIEW</p> <p>V_{CC} 1 □ 8 A R 2 □ 7 B D 3 □ 6 Z GND 4 □ 5 Y</p> <p>S8 PACKAGE 8-LEAD PLASTIC SO</p> <p>N8 PACKAGE 8-LEAD PLASTIC DIP</p> <p>T_{JMAX} = 125°C, θ_{JA} = 130°C/W (N) T_{JMAX} = 125°C, θ_{JA} = 135°C/W (S)</p>	ORDER PART NUMBER
	LTC1690CMS8		LTC1690CN8 LTC1690IN8 LTC1690CS8 LTC1690IS8
	MS8 PART MARKING		S8 PART MARKING
	LTDA		1690 1690I

Consult factory for Military Grade Parts

DC ELECTRICAL CHARACTERISTICS

The ● denotes the specifications which apply over the full operating temperature range, otherwise specifications are at $T_A = 25^{\circ}\text{C}$. $V_{CC} = 5V \pm 5\%$ (Notes 2, 3)

SYMBOL	PARAMETER	CONDITIONS	MIN	TYP	MAX	UNITS
V_{OD1}	Differential Driver Output Voltage (Unloaded)	$I_0 = 0$	●		V_{CC}	V
V_{OD2}	Differential Driver Output Voltage (with Load)	R = 50Ω; (RS422)	●	2		V
		R = 22Ω or 27Ω; (RS485), Figure 1	●	1.5	5	V
V_{OD3}	Differential Driver Output Voltage (with Common Mode)	$V_{TST} = -7V$ to 12V, Figure 2		1.5	5	V
ΔV_{OD}	Change in Magnitude of Driver Differential Output Voltage for Complementary Output States	R = 22Ω, 27Ω or 50Ω, Figure 1 $V_{TST} = -7V$ to 12V, Figure 2	●		0.2	V
V_{OC}	Driver Common Mode Output Voltage	R = 22Ω, 27Ω or 50Ω, Figure 1	●		3	V
$\Delta V_{OC} $	Change in Magnitude of Driver Common Mode Output Voltage for Complementary Output States	R = 22Ω, 27Ω or 50Ω, Figure 1	●		0.2	V
V_{IH}	Input High Voltage	Driver Input (D)	●	2		V
V_{IL}	Input Low Voltage	Driver Input (D)	●		0.8	V
I_{IN1}	Input Current	Driver Input (D)	●		± 2	μA
I_{IN2}	Input Current (A, B)	$V_{CC} = 0V$ or 5.25V, $V_{IN} = 12V$	●		1	mA
		$V_{CC} = 0V$ or 5.25V, $V_{IN} = -7V$	●		-0.8	mA
V_{TH}	Differential Input Threshold Voltage for Receiver	$-7V \leq V_{CM} \leq 12V$	●	-0.20	-0.01	V
ΔV_{TH}	Receiver Input Hysteresis	$V_{CM} = 0V$		± 30		mV

DC ELECTRICAL CHARACTERISTICS

The ● denotes the specifications which apply over the full operating temperature range, otherwise specifications are at $T_A = 25^\circ\text{C}$. $V_{CC} = 5V \pm 5\%$ (Notes 2, 3)

SYMBOL	PARAMETER	CONDITIONS	MIN	TYP	MAX	UNITS
V_{OH}	Receiver Output High Voltage	$I_O = -4\text{mA}$, $V_{ID} = 200\text{mV}$	● 3.5			V
V_{OL}	Receiver Output Low Voltage	$I_O = 4\text{mA}$, $V_{ID} = -200\text{mV}$	●		0.4	V
R_{IN}	Receiver Input Resistance	$-7V \leq V_{CM} \leq 12V$	● 12	22		$k\Omega$
I_{CC}	Supply Current	No Load	●	260	600	μA
I_{OSD1}	Driver Short-Circuit Current, $V_{OUT} = \text{HIGH}$	$-7V \leq V_O \leq 10V$			250	mA
I_{OSD2}	Driver Short-Circuit Current, $V_{OUT} = \text{LOW}$	$-7V \leq V_O \leq 10V$			250	mA
I_{OZ}	Driver Three-State Current (Y, Z)	$-7V \leq V_O \leq 10V$, $V_{CC} = 0V$	●	5	200	μA
I_{OSR}	Receiver Short-Circuit Current	$0V \leq V_O \leq V_{CC}$	● 7		85	mA
t_{PLH}	Driver Input to Output, Figure 3, Figure 4	$R_{DIFF} = 54\Omega$, $C_{L1} = C_{L2} = 100\text{pF}$	● 10	22.5	60	ns
t_{PHL}	Driver Input to Output, Figure 3, Figure 4	$R_{DIFF} = 54\Omega$, $C_{L1} = C_{L2} = 100\text{pF}$	● 10	25	60	ns
t_{SKEW}	Driver Output to Output, Figure 3, Figure 4	$R_{DIFF} = 54\Omega$, $C_{L1} = C_{L2} = 100\text{pF}$	●	2.5	15	ns
t_r , t_f	Driver Rise or Fall Time, Figure 3, Figure 4	$R_{DIFF} = 54\Omega$, $C_{L1} = C_{L2} = 100\text{pF}$	● 2	13	40	ns
t_{PLH}	Receiver Input to Output, Figure 3, Figure 5	$R_{DIFF} = 54\Omega$, $C_{L1} = C_{L2} = 100\text{pF}$	● 30	94	160	ns
t_{PHL}	Receiver Input to Output, Figure 3, Figure 5	$R_{DIFF} = 54\Omega$, $C_{L1} = C_{L2} = 100\text{pF}$	● 30	89	160	ns
t_{SKD}	$ t_{PLH} - t_{PHL} $, Differential Receiver Skew, Figure 3, Figure 5	$R_{DIFF} = 54\Omega$, $C_{L1} = C_{L2} = 100\text{pF}$		5		ns
f_{MAX}	Maximum Data Rate, Figure 3, Figure 5	$R_{DIFF} = 54\Omega$, $C_{L1} = C_{L2} = 100\text{pF}$	● 5			Mbps

Note 1: Absolute Maximum Ratings are those values beyond which the life of the device may be impaired.

Note 2: All currents into device pins are positive; all currents out of device pins are negative. All voltages are referenced to device ground unless otherwise specified.

Note 3: All typicals are given for $V_{CC} = 5V$ and $T_A = 25^\circ\text{C}$.

TYPICAL PERFORMANCE CHARACTERISTICS

Receiver Input Threshold Voltage (Output High) vs Temperature

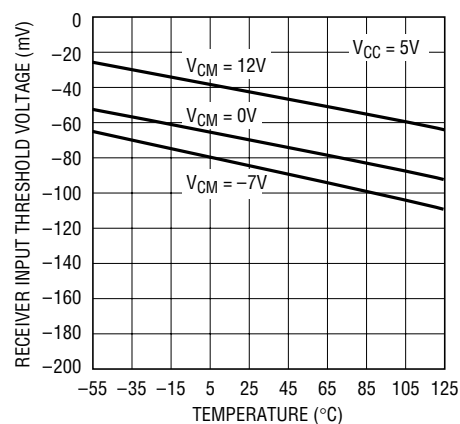

1690 G01

Receiver Input Threshold Voltage (Output Low) vs Temperature

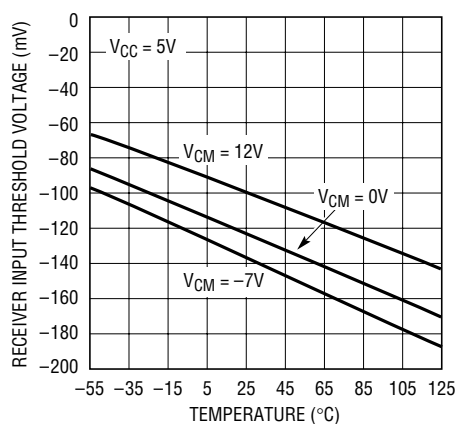

1690 G02

Receiver Hysteresis vs Temperature

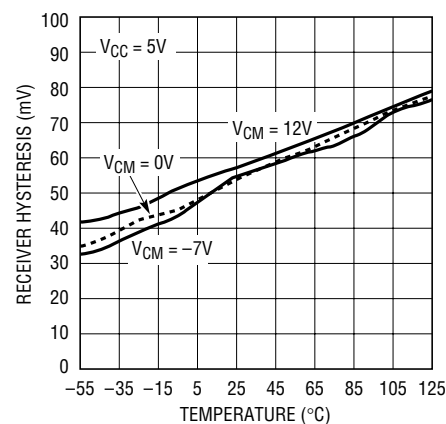

1690 G03

TYPICAL PERFORMANCE CHARACTERISTICS

Receiver Input Offset Voltage vs Temperature

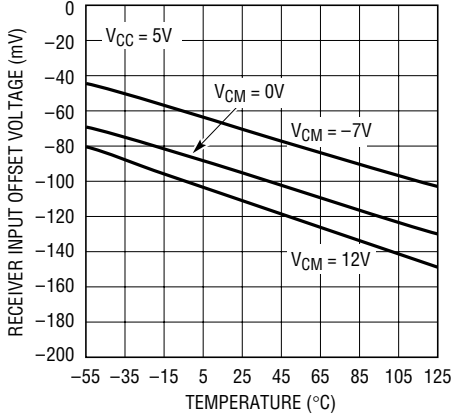

1690 G04

Receiver Input Threshold Voltage vs Supply Voltage

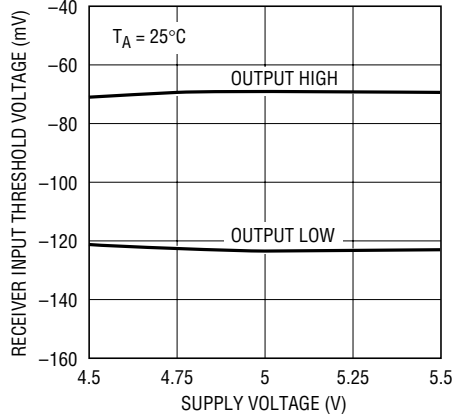

1690 G05

Receiver Output High Voltage vs Output Current

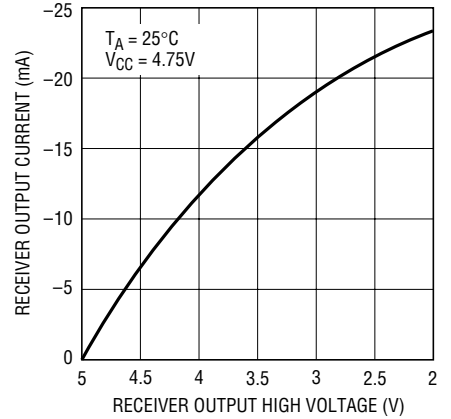

1690 G06

Receiver Output Low Voltage vs Output Current

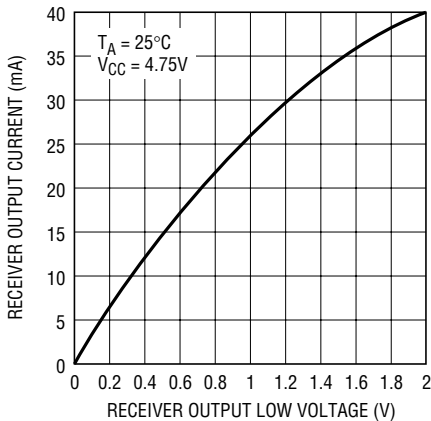

1690 G07

Receiver Output High Voltage vs Temperature

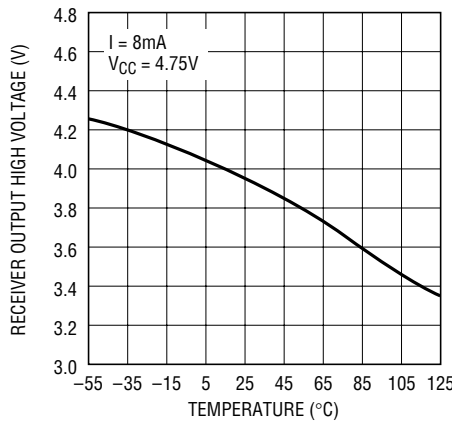

1690 G08

Receiver Output Low Voltage vs Temperature

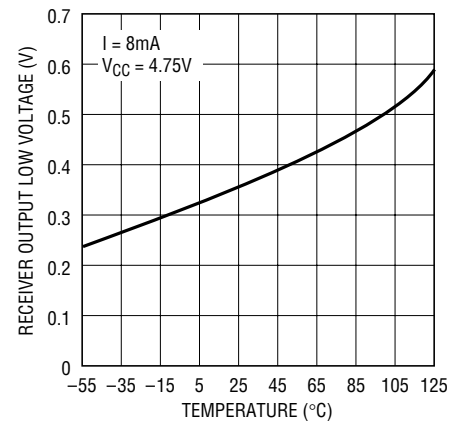

1690 G09

Receiver Propagation Delay vs Temperature

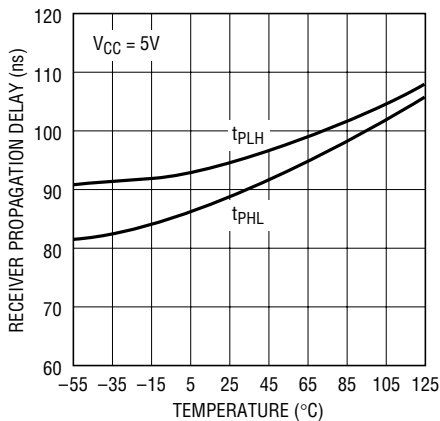

1690 G10

Receiver Skew |t_{PLH} - t_{PHL}| vs Temperature

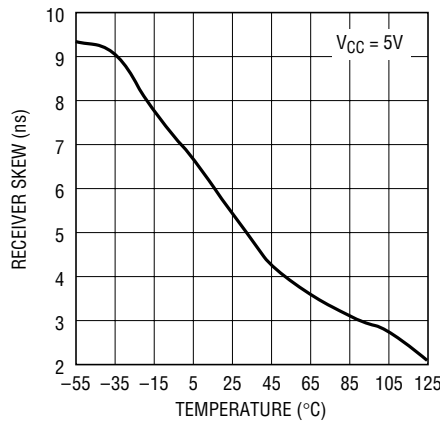

1690 G11

Receiver Propagation Delay vs Supply Voltage

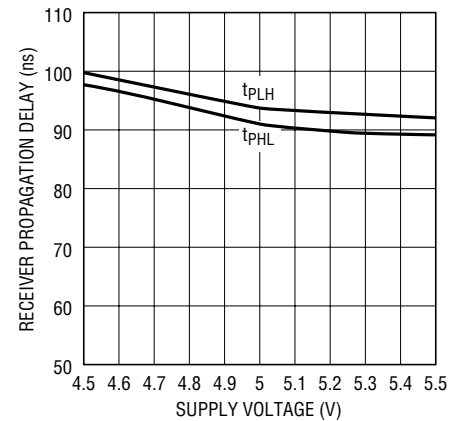

1690 G12

TYPICAL PERFORMANCE CHARACTERISTICS

Receiver Short-Circuit Current vs Temperature

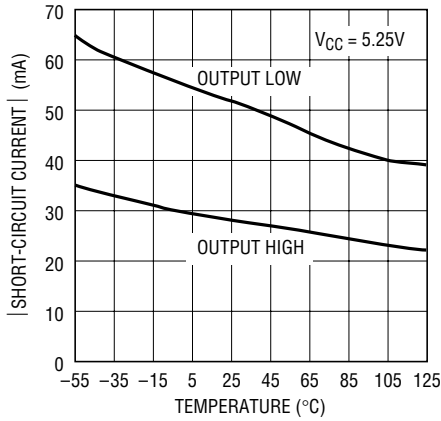

1690 G13

Supply Current vs Temperature

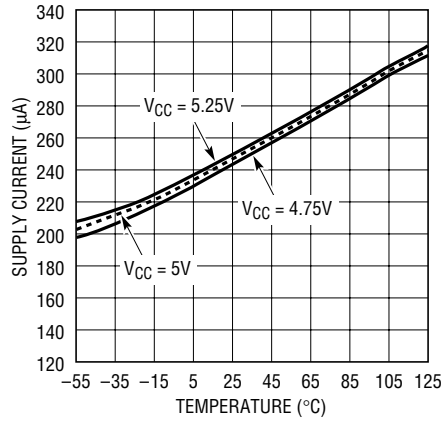

1690 G14

Logic Input Threshold Voltage vs Temperature

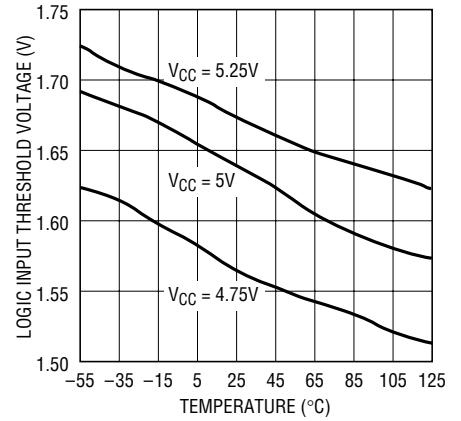

1690 G15

Driver Differential Output Voltage vs Temperature

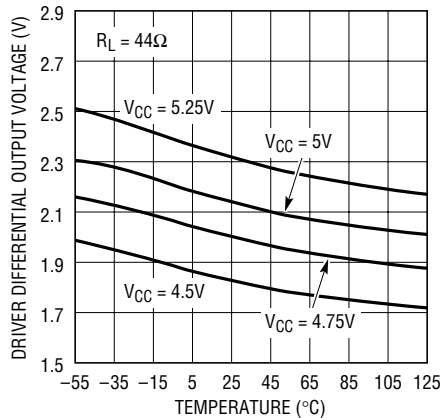

1690 G16

Driver Differential Output Voltage vs Temperature

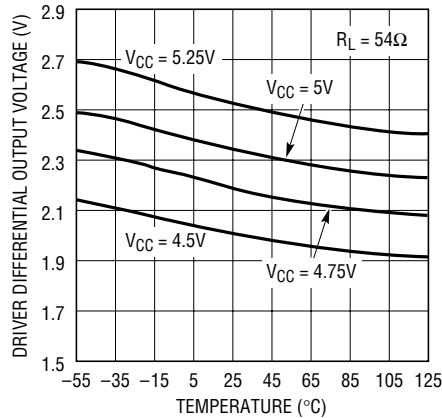

1690 G17

Driver Differential Output Voltage vs Temperature

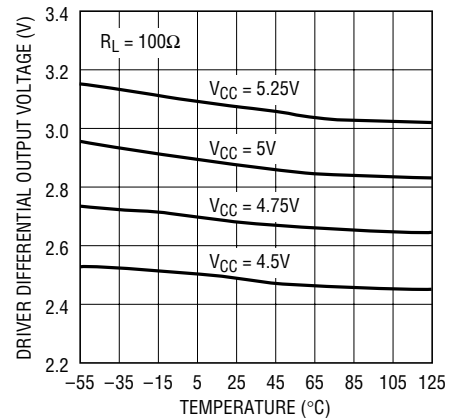

1690 G18

Driver Common Mode Output Voltage vs Temperature

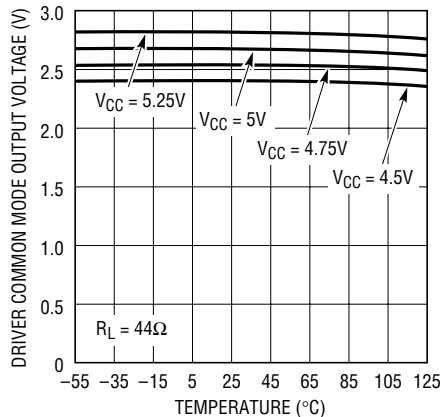

1690 G19

Driver Common Mode Output Voltage vs Temperature

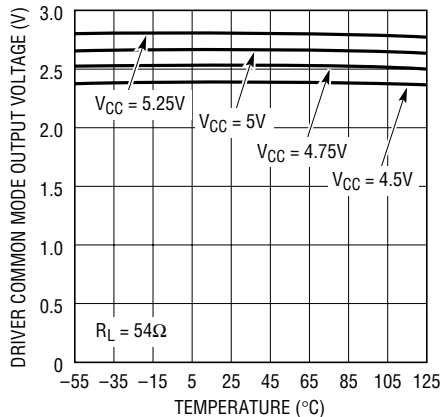

1690 G20

Driver Common Mode Output Voltage vs Temperature

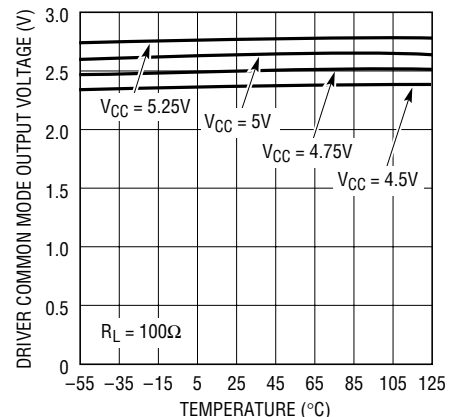

1690 G21

TYPICAL PERFORMANCE CHARACTERISTICS

Driver Differential Output Voltage vs Output Current

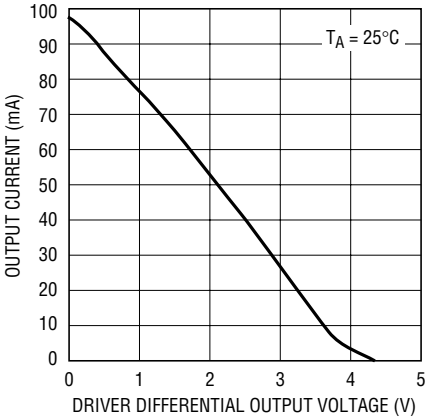

1690 G22

Driver Output High Voltage vs Output Current

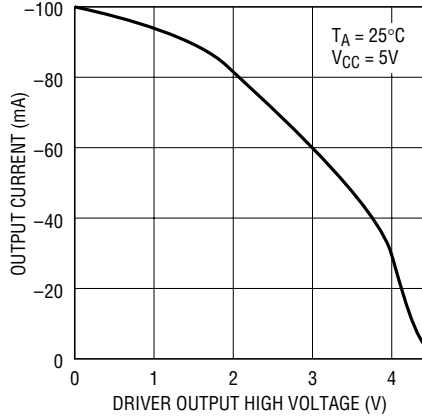

1690 G23

Driver Output Low Voltage vs Output Current

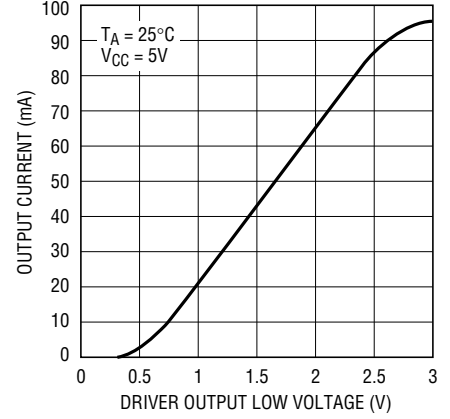

1690 G24

Driver Propagation Delay vs Temperature

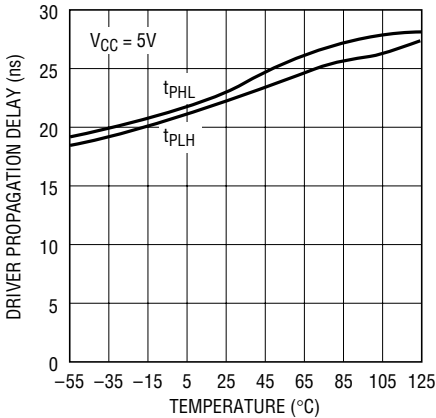

1690 G25

Driver Skew vs Temperature

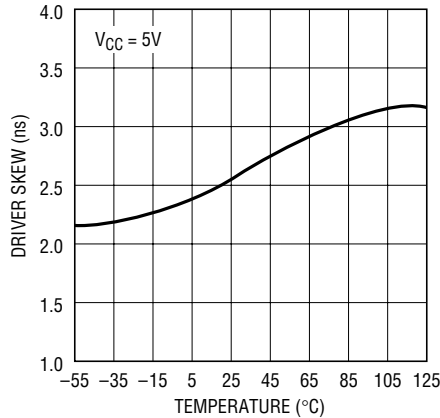

1690 G26

Driver Propagation Delay vs Supply Voltage

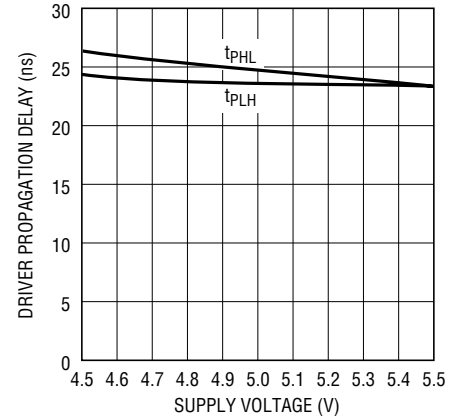

1690 G27

Driver Short-Circuit Current vs Temperature

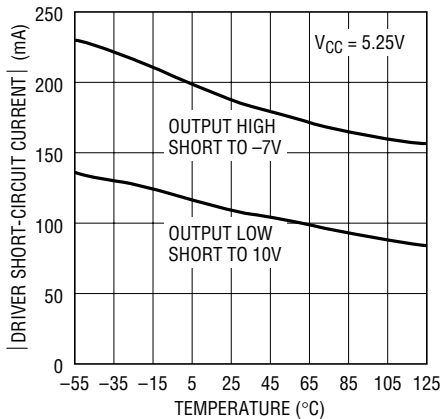

1690 G29

Receiver Input Resistance vs Temperature

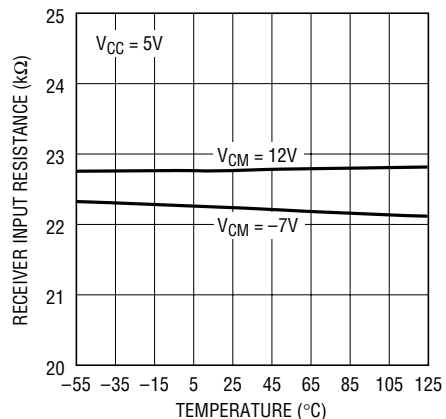

1690 G30

PIN FUNCTIONS

V_{CC} (Pin 1): Positive Supply. $4.75V < V_{CC} < 5.25V$.

R (Pin 2): Receiver Output. R is high if $(A - B) \geq -10mV$ and low if $(A - B) \leq -200mV$.

D (Pin 3): Driver Input. If D is high, Y is taken high and Z is taken low. If D is low, Y is taken low and Z is taken high.

GND (Pin 4): Ground.

Y (Pin 5): Driver Output.

Z (Pin 6): Driver Output.

B (Pin 7): Receiver Input.

A (Pin 8): Receiver Input.

TEST CIRCUITS

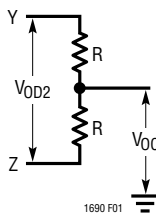

Figure 1. Driver DC Test Load #1

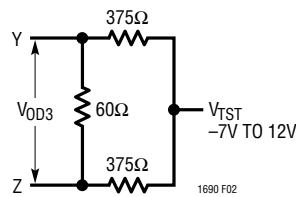

Figure 2. Driver DC Test Load #2

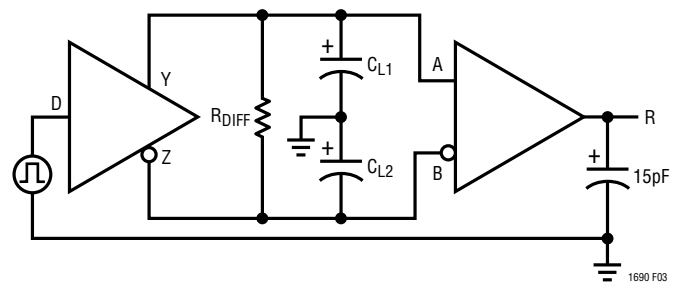

Figure 3. Driver/Receiver Timing Test Load

SWITCHING TIME WAVEFORMS

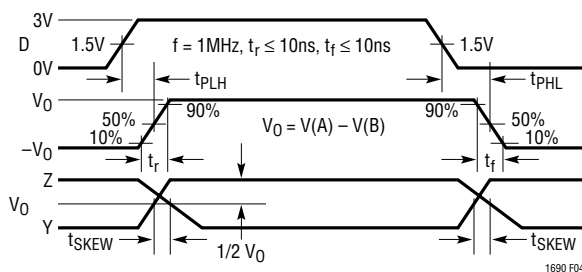

Figure 4. Driver Propagation Delays

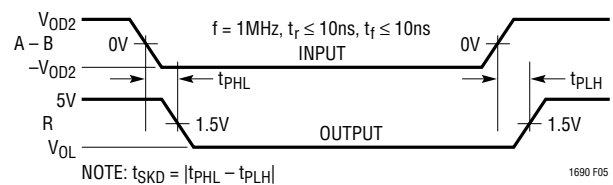

Figure 5. Receiver Propagation Delays

FUNCTION TABLES

Driver

D	Z	Y
1	0	1
0	1	0

Receiver

A - B	R
$\geq -0.01V$	1
$\leq -0.20V$	0
Inputs Open	1
Inputs Shorted	1

Note: Table valid with or without termination resistors.

APPLICATIONS INFORMATION

A typical application is shown in Figure 6. Two twisted pair wires connect two driver/receiver pairs for full duplex data transmission. Note that the driver and receiver outputs are always enabled. If the outputs must be disabled, use the LTC491. There are no restrictions on where the chips are connected, and it isn't necessary to have the chips connected to the ends of the wire. However, the wires must be terminated at the ends with a resistor equal to their characteristic impedance, typically 120Ω . Because only one driver can be connected on the bus, the cable need only be terminated at the receiving end. The optional shields around the twisted pair are connected to GND at one end and help reduce unwanted noise.

The LTC1690 can be used as a line repeater as shown in Figure 7. If the cable is longer than 4000 feet, the LTC1690 is inserted in the middle of the cable with the receiver output connected back to the driver input.

Receiver Fail-Safe

Some encoding schemes require that the output of the receiver maintains a known state (usually a logic 1) when data transmission ends and all drivers on the line are forced into three-state. The receiver of the LTC1690 has a fail-safe feature which guarantees the output to be in a

logic 1 state when the receiver inputs are left floating or shorted together. This is achieved without external components by designing the trip-point of the LTC1690 to be within -200mV to -10mV . If the receiver output must be a logic 0 instead of a logic 1, external components are required.

The LTC1690 fail-safe receiver is designed to reject fast -7V to 12V common mode steps at its inputs. The slew rate that the receiver will reject is typically $400\text{V}/\mu\text{s}$, but -7V to 12V steps in 10ns can be tolerated if the frequency of the common mode step is moderate ($<600\text{kHz}$).

Driver-Receiver Crosstalk

The driver outputs generate fast rise and fall times. If the LTC1690 receiver inputs are not terminated and floating, switching noise from the LTC1690 driver can couple into the receiver inputs and cause the receiver output to glitch. This can be prevented by ensuring that the receiver inputs are terminated with a 100Ω or 120Ω resistor, depending on the type of cable used. A cable capacitance that is greater than 10pF ($\approx 1\text{ft}$ of cable) also prevents glitches if no termination is present. The receiver inputs should not be driven typically above 8MHz to prevent glitches.

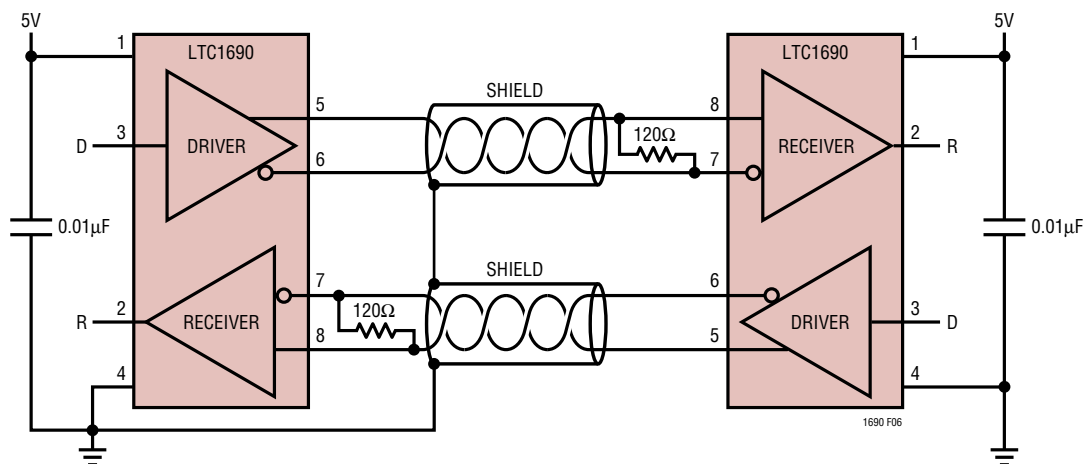

Figure 6. Typical Application

APPLICATIONS INFORMATION

Fault Protection

When shorted to $-7V$ or $10V$ at room temperature, the short-circuit current in the driver outputs is limited by internal resistance or protection circuitry to $250mA$ maximum. Over the industrial temperature range, the absolute maximum positive voltage at any driver output should be limited to $10V$ to avoid damage to the driver outputs. At higher ambient temperatures, the rise in die temperature due to the short-circuit current may trip the thermal shutdown circuit.

The receiver inputs can withstand the entire $-7V$ to $12V$ RS485 common mode range without damage.

The LTC1690 includes a thermal shutdown circuit that protects the part against prolonged shorts at the driver outputs. If a driver output is shorted to another output or

to V_{CC} , the current will be limited to a maximum of $250mA$. If the die temperature rises above $150^{\circ}C$, the thermal shutdown circuit three-states the driver outputs to open the current path. When the die cools down to about $130^{\circ}C$, the driver outputs are taken out of three-state. If the short persists, the part will heat again and the cycle will repeat. This thermal oscillation occurs at about $10Hz$ and protects the part from excessive power dissipation. The average fault current drops as the driver cycles between active and three-state. When the short is removed, the part will return to normal operation.

If the outputs of two or more LTC1690 drivers are shorted directly, the driver outputs cannot supply enough current to activate the thermal shutdown. Thus, the thermal shutdown circuit will not prevent contention faults when two drivers are active on the bus at the same time.

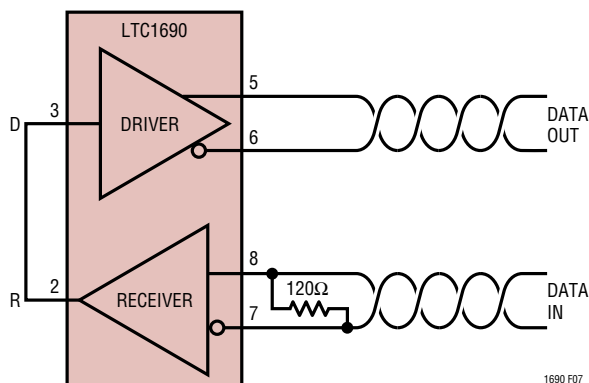

Figure 7. Line Repeater

APPLICATIONS INFORMATION

Cables and Data Rate

The transmission line of choice for RS485 applications is a twisted pair. There are coaxial cables (twinaxial) made for this purpose that contain straight pairs, but these are less flexible, more bulky and more costly than twisted pairs. Many cable manufacturers offer a broad range of 120Ω cables designed for RS485 applications.

Losses in a transmission line are a complex combination of DC conductor loss, AC losses (skin effect), leakage and AC losses in the dielectric. In good polyethylene cables such as Belden 9841, the conductor losses and dielectric losses are of the same order of magnitude, leading to relatively low overall loss (Figure 8).

When using low loss cable, Figure 9 can be used as a guideline for choosing the maximum length for a given data rate. With lower quality PVC cables, the dielectric loss factor can be 1000 times worse. PVC twisted pairs have terrible losses at high data rates (>100kbits/s), reducing the maximum cable length. At low data rates, they are acceptable and are more economical. The LTC1690 is tested and guaranteed to drive CAT 5 cable and terminations as well as common low cost residential telephone wire.

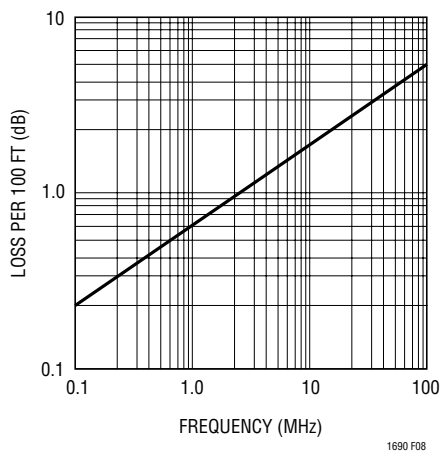

Figure 8. Attenuation vs Frequency for Belden 9841

ESD PROTECTION

The ESD performance of the LTC1690 driver outputs (Z, Y) and the receiver inputs (A, B) is as follows:

- Meets $\pm 15\text{kV}$ Human Body Model (100pF, 1.5kΩ).
- Meets IEC1000-4-2 Level 4 ($\pm 8\text{kV}$) contact mode specifications.
- Meets IEC1000-4-2 Level 3 ($\pm 8\text{kV}$) air discharge specifications.

This level of ESD performance means that external voltage suppressors are not required in many applications, when compared with parts that are only protected to $\pm 2\text{kV}$. The LTC1690 driver input (D) and receiver output are protected to $\pm 2\text{kV}$ per the Human Body Model.

When powered up, the LTC1690 does not latch up or sustain damage when the Z, Y, A or B pins are subjected to any of the conditions listed above. The data during the ESD event may be corrupted, but after the event the LTC1690 continues to operate normally.

The additional ESD protection at the LTC1690 Z, Y, A and B pins is important in applications where these pins are exposed to the external world via socket connections.

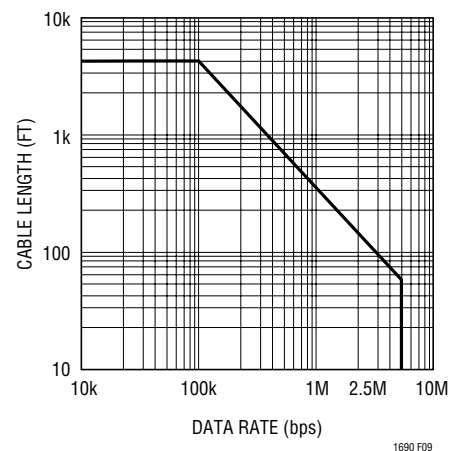
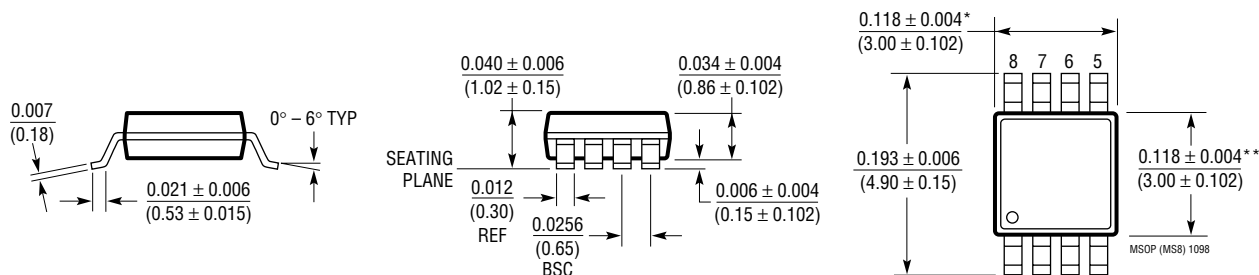

Figure 9. RS485 Cable Length Recommended. Applies for 24 Gauge, Polyethylene Dielectric Twisted Pair

PACKAGE DESCRIPTION Dimensions in inches (millimeters) unless otherwise noted.

MS8 Package 8-Lead Plastic MSOP (LTC DWG # 05-08-1660)



* DIMENSION DOES NOT INCLUDE MOLD FLASH, PROTRUSIONS OR GATE BURRS. MOLD FLASH, PROTRUSIONS OR GATE BURRS SHALL NOT EXCEED 0.006" (0.152mm) PER SIDE
 ** DIMENSION DOES NOT INCLUDE INTERLEAD FLASH OR PROTRUSIONS. INTERLEAD FLASH OR PROTRUSIONS SHALL NOT EXCEED 0.006" (0.152mm) PER SIDE

N8 Package 8-Lead PDIP (Narrow 0.300) (LTC DWG # 05-08-1510)

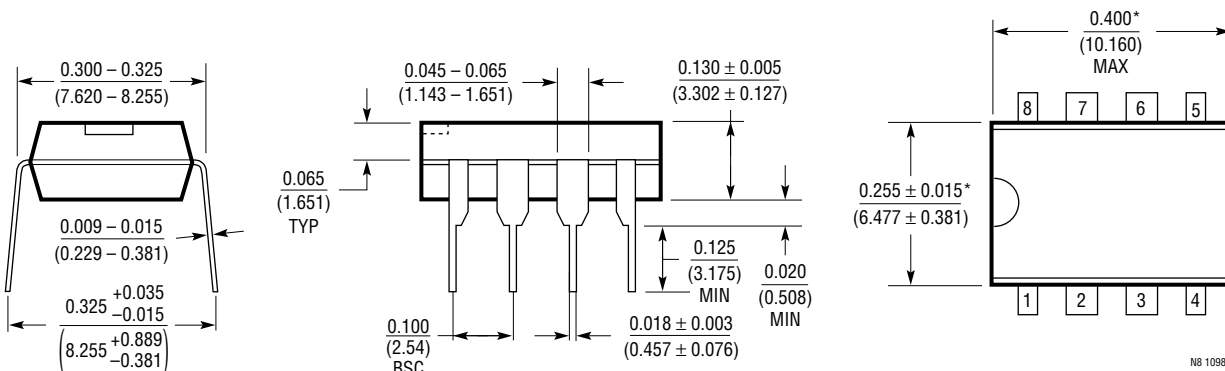

* THESE DIMENSIONS DO NOT INCLUDE MOLD FLASH OR PROTRUSIONS. MOLD FLASH OR PROTRUSIONS SHALL NOT EXCEED 0.010 INCH (0.254mm)

S8 Package 8-Lead Plastic Small Outline (Narrow 0.150) (LTC DWG # 05-08-1610)

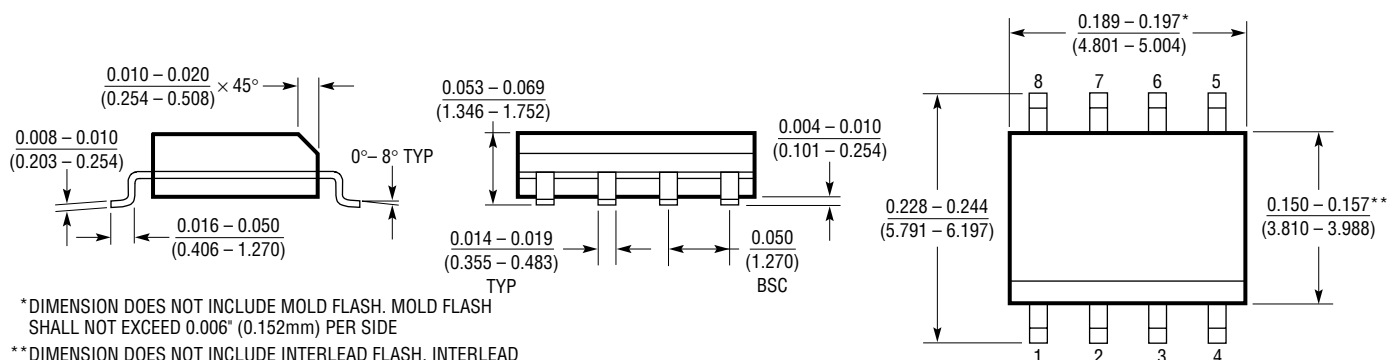

* DIMENSION DOES NOT INCLUDE MOLD FLASH. MOLD FLASH SHALL NOT EXCEED 0.006" (0.152mm) PER SIDE
 ** DIMENSION DOES NOT INCLUDE INTERLEAD FLASH. INTERLEAD FLASH SHALL NOT EXCEED 0.010" (0.254mm) PER SIDE

TYPICAL APPLICATIONS

Receiver with Low Fail-Safe Output

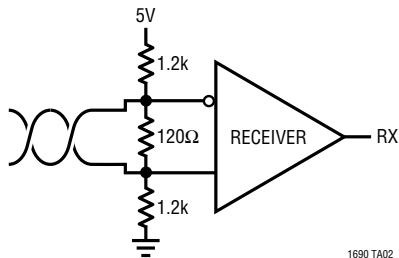

RS232 Receiver

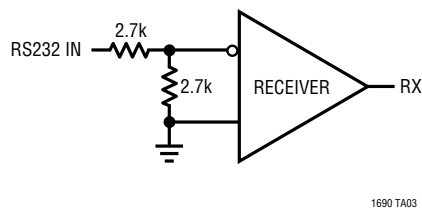

RELATED PARTS

PART NUMBER	DESCRIPTION	COMMENTS
LTC485	5V Low Power RS485 Interface Transceiver	Low Power
LTC1480	3.3V Ultralow Power RS485 Transceiver with Shutdown	Lower Supply Voltage
LTC1481	5V Ultralow Power RS485 Transceiver with Shutdown	Lowest Power
LTC1482	5V Low Power RS485 Transceiver with Carrier Detect Output	Low Power, High Output State when Inputs are Open, Shorted or Terminated, ±15kV ESD Protection
LTC1483	5V Ultralow Power RS485 Low EMI Transceiver with Shutdown	Low EMI, Lowest Power
LTC1484	5V Low Power RS485 Transceiver with Fail-Safe Receiver Circuit	Low Power, High Output State when Inputs are Open, Shorted or Terminated, ±15kV ESD Protection
LTC1485	5V RS485 Transceiver	High Speed, 10Mbps
LTC1487	5V Ultralow Power RS485 with Low EMI, Shutdown and High Input Impedance	Highest Input Impedance, Low EMI, Lowest Power
LTC490	5V Differential Driver and Receiver Pair	Low Power, Pin Compatible with LTC1690
LTC491	5V Low Power RS485 Full-Duplex Transceiver	Low Power
LTC1535	Isolated RS485 Transceiver	2500V _{RMS} Isolation, Full Duplex
LTC1685	52Mbps, RS485 Fail-Safe Transceiver	Pin Compatible with LTC485
LTC1686/LTC1687	52Mbps, RS485 Fail-Safe Driver/Receiver	Pin Compatible with LTC490/LTC491
LT1785/LT1791	±60V Fault Protected RS485 Half-/Full-Duplex Transceiver	±15kV ESD Protection

Looking for pricing, stock, or lifecycle information?

Click below to explore more details on WIN SOURCE:

 [View LTC1690CMS8#TRPBF on WIN SOURCE](#)

 [Analog Devices Inc. Information](#)

Optimize Your Supply Chain with WIN SOURCE Solutions

-  Global Sourcing Solution
-  Obsolete Management
-  Cost Control Management
-  Shortage Management
-  Alternative Solution
-  Excess Inventory Management