



**THE DATASHEET OF  
LT6010ACS8#TRPBF**



# 135 $\mu$ A, 14nV/ $\sqrt{\text{Hz}}$ , Rail-to-Rail Output Precision Op Amp with Shutdown

## FEATURES

- 35 $\mu$ V Maximum Offset Voltage
- 110pA Maximum Input Bias Current
- 135 $\mu$ A Supply Current
- Rail-to-Rail Output Swing
- 12 $\mu$ A Supply Current in Shutdown
- 120dB Minimum Voltage Gain ( $V_S = \pm 15\text{V}$ )
- 0.8 $\mu\text{V}/^\circ\text{C}$  Maximum  $V_{OS}$  Drift
- 14nV/ $\sqrt{\text{Hz}}$  Input Noise Voltage
- 2.7V to  $\pm 18\text{V}$  Supply Voltage Operation
- Operating Temperature Range:  $-40^\circ\text{C}$  to  $85^\circ\text{C}$
- Space Saving 3mm  $\times$  3mm DFN Package

## APPLICATIONS

- Thermocouple Amplifiers
- Precision Photo Diode Amplifiers
- Instrumentation Amplifiers
- Battery-Powered Precision Systems

## DESCRIPTION

The LT<sup>®</sup>6010 op amp combines low noise and high precision input performance with low power consumption and rail-to-rail output swing.

Input offset voltage is trimmed to less than 35 $\mu\text{V}$ . The low drift and excellent long-term stability guarantee a high accuracy over temperature and over time. The 110pA maximum input bias current and 120dB minimum voltage gain further maintain this precision over operating conditions.

The LT6010 works on any power supply voltage from 2.7V to 36V, and draws only 135 $\mu\text{A}$  of supply current on a 5V supply. A power saving shutdown feature reduces supply current to 12 $\mu\text{A}$ . The output voltage swings to within 40mV of either supply rail, making the amplifier a good choice for low voltage single supply operation.

The LT6010 is fully specified at 5V and  $\pm 15\text{V}$  supplies and from  $-40^\circ\text{C}$  to  $85^\circ\text{C}$ . The device is available in SO-8 and space-saving 3mm  $\times$  3mm DFN packages. This op amp is also available in dual (LT6011) and quad (LT6012) packages.

 LTC and LT are registered trademarks of Linear Technology Corporation.

## TYPICAL APPLICATION

Single Supply Current Source for Platinum RTD

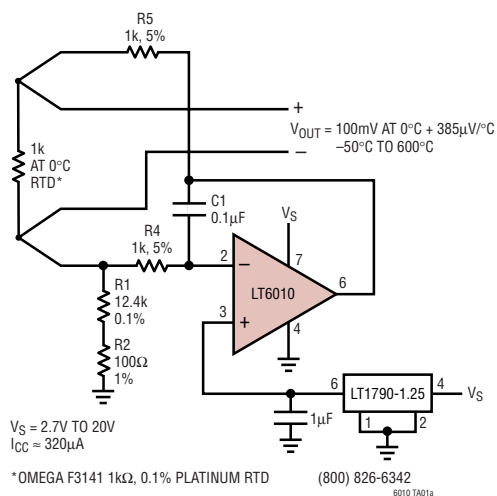

Distribution of Offset Voltage Drift

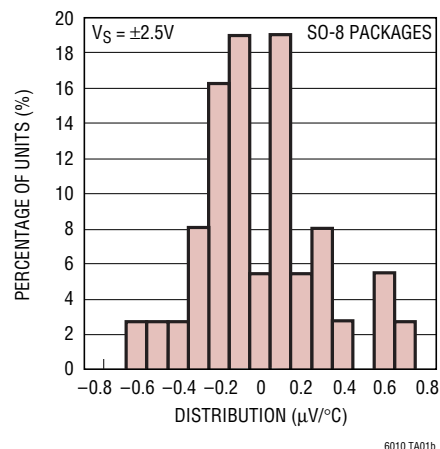

# LT6010

## ABSOLUTE MAXIMUM RATINGS (Note 1)

Total Supply Voltage ( $V^+$ to $V^-$ ) .....	40V	Maximum Junction Temperature	
Differential Input Voltage (Note 2) .....	10V	DD Package .....	125°C
Input Voltage, Shutdown Voltage .....	$V^+$ to $V^-$	SO-8 Package .....	150°C
Input Current (Note 2) .....	$\pm 10\text{mA}$	Storage Temperature Range	
Output Short-Circuit Duration (Note 3) .....	Indefinite	DD Package .....	-65°C to 125°C
Operating Temperature Range (Note 4) ..	-40°C to 85°C	SO-8 Package .....	-65°C to 150°C
Specified Temperature Range (Note 5) ...	-40°C to 85°C	Lead Temperature (Soldering, 10 sec) .....	300°C

## PACKAGE/ORDER INFORMATION

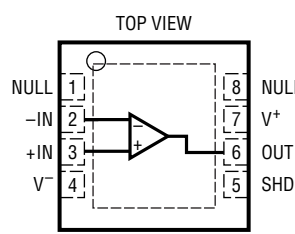
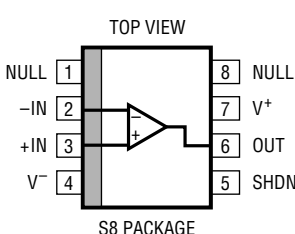
 <p>DD PACKAGE 8-LEAD (3mm x 3mm) PLASTIC DFN <math>T_{JMAX} = 125^\circ\text{C}</math>, <math>\theta_{JA} = 160^\circ\text{C/W}</math> UNDERSIDE METAL INTERNALLY CONNECTED TO <math>V^-</math> (PCB CONNECTION OPTIONAL)</p>	ORDER PART NUMBER	 <p>S8 PACKAGE 8-LEAD PLASTIC SO <math>T_{JMAX} = 150^\circ\text{C}</math>, <math>\theta_{JA} = 190^\circ\text{C/W}</math></p>	ORDER PART NUMBER
	LT6010CDD LT6010IDD LT6010ACDD LT6010AIDD		LT6010CS8 LT6010IS8 LT6010ACS8 LT6010AIS8
	DD PART MARKING*		S8 PART MARKING
LADU	6010 6010I 6010A 6010AI		

\*Temperature grades are identified by a label on the shipping container.  
Consult LTC Marketing for parts specified with wider operating temperature ranges.

## ELECTRICAL CHARACTERISTICS

The ● denotes the specifications which apply over the full operating temperature range, otherwise specifications are at  $T_A = 25^\circ\text{C}$ .  $V_S = 5\text{V}$ ,  $0\text{V}$ ;  $V_{CM} = 2.5\text{V}$ ;  $R_L$  to  $0\text{V}$ ;  $\text{SHDN} = 0.2\text{V}$ , unless otherwise specified. (Note 5)

SYMBOL	PARAMETER	CONDITIONS	MIN	TYP	MAX	UNITS
$V_{OS}$	Input Offset Voltage (Note 7)	LT6010AS8 $T_A = 0^\circ\text{C}$ to $70^\circ\text{C}$ $T_A = -40^\circ\text{C}$ to $85^\circ\text{C}$	●	10	35	$\mu\text{V}$
			●		60	$\mu\text{V}$
			●		75	$\mu\text{V}$
		LT6010S8 $T_A = 0^\circ\text{C}$ to $70^\circ\text{C}$ $T_A = -40^\circ\text{C}$ to $85^\circ\text{C}$	●	20	55	$\mu\text{V}$
		●		85	$\mu\text{V}$	
		●		110	$\mu\text{V}$	
	LT6010ADD $T_A = 0^\circ\text{C}$ to $70^\circ\text{C}$ $T_A = -40^\circ\text{C}$ to $85^\circ\text{C}$	●	20	60	$\mu\text{V}$	
		●		85	$\mu\text{V}$	
		●		100	$\mu\text{V}$	
	LT6010DD $T_A = 0^\circ\text{C}$ to $70^\circ\text{C}$ $T_A = -40^\circ\text{C}$ to $85^\circ\text{C}$	●	30	80	$\mu\text{V}$	
		●		110	$\mu\text{V}$	
		●		135	$\mu\text{V}$	
$\Delta V_{OS}/\Delta T$	Input Offset Voltage Drift (Note 6)	LT6010AS8, LT6010S8	●	0.2	0.8	$\mu\text{V}/^\circ\text{C}$
		LT6010ADD, LT6010DD	●	0.2	1.3	$\mu\text{V}/^\circ\text{C}$

sn6010 6010fs

**ELECTRICAL CHARACTERISTICS** The ● denotes the specifications which apply over the full operating temperature range, otherwise specifications are at  $T_A = 25^\circ\text{C}$ .  $V_S = 5\text{V}$ ,  $0\text{V}$ ;  $V_{CM} = 2.5\text{V}$ ;  $R_L$  to  $0\text{V}$ ;  $\text{SHDN} = 0.2\text{V}$ , unless otherwise specified. (Note 5)

SYMBOL	PARAMETER	CONDITIONS	MIN	TYP	MAX	UNITS
$I_{OS}$	Input Offset Current (Note 7)	LT6010AS8 $T_A = 0^\circ\text{C}$ to $70^\circ\text{C}$ ● $T_A = -40^\circ\text{C}$ to $85^\circ\text{C}$ ●		20	110	pA
					150	pA
					200	pA
		LT6010S8 $T_A = 0^\circ\text{C}$ to $70^\circ\text{C}$ ● $T_A = -40^\circ\text{C}$ to $85^\circ\text{C}$ ●		40	200	pA
				300	pA	
				400	pA	
	LT6010ADD $T_A = 0^\circ\text{C}$ to $70^\circ\text{C}$ ● $T_A = -40^\circ\text{C}$ to $85^\circ\text{C}$ ●			20	200	pA
					300	pA
					400	pA
		LT6010DD $T_A = 0^\circ\text{C}$ to $70^\circ\text{C}$ ● $T_A = -40^\circ\text{C}$ to $85^\circ\text{C}$ ●		40	300	pA
				400	pA	
				500	pA	
$I_B$	Input Bias Current (Note 7)	LT6010AS8 $T_A = 0^\circ\text{C}$ to $70^\circ\text{C}$ ● $T_A = -40^\circ\text{C}$ to $85^\circ\text{C}$ ●		20	$\pm 110$	pA
					$\pm 150$	pA
					$\pm 200$	pA
		LT6010S8 $T_A = 0^\circ\text{C}$ to $70^\circ\text{C}$ ● $T_A = -40^\circ\text{C}$ to $85^\circ\text{C}$ ●		40	$\pm 200$	pA
				$\pm 300$	pA	
				$\pm 400$	pA	
	LT6010ADD $T_A = 0^\circ\text{C}$ to $70^\circ\text{C}$ ● $T_A = -40^\circ\text{C}$ to $85^\circ\text{C}$ ●			20	$\pm 200$	pA
					$\pm 300$	pA
					$\pm 400$	pA
		LT6010DD $T_A = 0^\circ\text{C}$ to $70^\circ\text{C}$ ● $T_A = -40^\circ\text{C}$ to $85^\circ\text{C}$ ●		40	$\pm 300$	pA
				$\pm 400$	pA	
				$\pm 500$	pA	
	Input Noise Voltage	0.1Hz to 10Hz		400		nV <sub>p-p</sub>
$e_n$	Input Noise Voltage Density	f = 1kHz		14		nV/ $\sqrt{\text{Hz}}$
$i_n$	Input Noise Current Density	f = 1kHz		0.1		pA/ $\sqrt{\text{Hz}}$
$R_{IN}$	Input Resistance	Common Mode, $V_{CM} = 1\text{V}$ to $3.8\text{V}$	10	120		G $\Omega$
		Differential		20		M $\Omega$
$C_{IN}$	Input Capacitance			4		pF
$V_{CM}$	Input Voltage Range (Positive)	Guaranteed by CMRR	● 3.8	4		V
	Input Voltage Range (Negative)	Guaranteed by CMRR	●	0.7	1	V
CMRR	Common Mode Rejection Ratio	$V_{CM} = 1\text{V}$ to $3.8\text{V}$	● 107	135		dB
	Minimum Supply Voltage	Guaranteed by PSRR	●	2.4	2.7	V
PSRR	Power Supply Rejection Ratio	$V_S = 2.7\text{V}$ to $36\text{V}$ , $V_{CM} = 1/2V_S$	● 112	135		dB
$A_{VOL}$	Large-Signal Voltage Gain	$R_L = 10\text{k}$ , $V_{OUT} = 1\text{V}$ to $4\text{V}$	● 300	2000		V/mV
		$R_L = 2\text{k}$ , $V_{OUT} = 1\text{V}$ to $4\text{V}$	● 250	2000		V/mV
$V_{OUT}$	Maximum Output Swing (Positive, Referred to $V^+$ )	No Load, 50mV Overdrive	●	35	55	mV
					65	mV
	$I_{SOURCE} = 1\text{mA}$ , 50mV Overdrive		●	120	170	mV
					220	mV
Maximum Output Swing (Negative, Referred to $0\text{V}$ )	No Load, 50mV Overdrive	●	40	55	mV	
				65	mV	
	$I_{SINK} = 1\text{mA}$ , 50mV Overdrive		●	150	225	mV
					275	mV

## ELECTRICAL CHARACTERISTICS

The ● denotes the specifications which apply over the full operating temperature range, otherwise specifications are at  $T_A = 25^\circ\text{C}$ .  $V_S = 5\text{V}$ ,  $0\text{V}$ ;  $V_{\text{CM}} = 2.5\text{V}$ ;  $R_L$  to  $0\text{V}$ ;  $\text{SHDN} = 0.2\text{V}$ , unless otherwise specified. (Note 5)

SYMBOL	PARAMETER	CONDITIONS	MIN	TYP	MAX	UNITS
$I_{\text{SC}}$	Output Short-Circuit Current (Note 3)	$V_{\text{OUT}} = 0\text{V}$ , 1V Overdrive (Source)	● 10 4	14		mA mA
		$V_{\text{OUT}} = 5\text{V}$ , -1V Overdrive (Sink)	● 10 4	21		mA mA
SR	Slew Rate	$A_V = -10$ , $R_F = 50\text{k}$ , $R_G = 5\text{k}$ $T_A = 0^\circ\text{C}$ to $70^\circ\text{C}$ $T_A = -40^\circ\text{C}$ to $85^\circ\text{C}$	● ● ●	0.06 0.05 0.04		V/ $\mu\text{s}$ V/ $\mu\text{s}$ V/ $\mu\text{s}$
GBW	Gain Bandwidth Product	$f = 10\text{kHz}$	● 250 225	330		kHz kHz
$t_s$	Settling Time	$A_V = -1$ , 0.01%, $V_{\text{OUT}} = 1.5\text{V}$ to $3.5\text{V}$		45		$\mu\text{s}$
$t_r$ , $t_f$	Rise Time, Fall Time	$A_V = 1$ , 10% to 90%, 0.1V Step		1		$\mu\text{s}$
$I_{\text{SHDN}}$	SHDN Pin Current	$\text{SHDN} \leq V^- + 0.2\text{V}$ (On)	●		0.25	$\mu\text{A}$
		$\text{SHDN} = V^- + 2.0\text{V}$ (Off)	●	15	25	$\mu\text{A}$
$t_{\text{SHDN}}$	SHDN Turn-On, Turn-Off Time	$\text{SHDN} = V^-$ (On) to $V^- + 2.0\text{V}$ (Off)		25		$\mu\text{s}$
		$\text{SHDN} = V^- + 2.0\text{V}$ (Off) to $V^-$ (On)		25		$\mu\text{s}$
$I_S$	Supply Current	$\text{SHDN} \leq V^- + 0.2\text{V}$ (On) $T_A = 0^\circ\text{C}$ to $70^\circ\text{C}$ $T_A = -40^\circ\text{C}$ to $85^\circ\text{C}$	● ● ●	135	150	$\mu\text{A}$ $\mu\text{A}$ $\mu\text{A}$
		$\text{SHDN} = V^- + 2.0\text{V}$ (Off)	●	12	25	$\mu\text{A}$
					50	$\mu\text{A}$

The ● denotes the specifications which apply over the full operating temperature range, otherwise specifications are at  $T_A = 25^\circ\text{C}$ .  $V_S = \pm 15\text{V}$ ,  $V_{\text{CM}} = 0\text{V}$ ,  $R_L$  to  $0\text{V}$ ;  $\text{SHDN} = -14.8\text{V}$ , unless otherwise specified. (Note 5)

SYMBOL	PARAMETER	CONDITIONS	MIN	TYP	MAX	UNITS
$V_{\text{OS}}$	Input Offset Voltage (Note 7)	LT6010AS8 $T_A = 0^\circ\text{C}$ to $70^\circ\text{C}$ $T_A = -40^\circ\text{C}$ to $85^\circ\text{C}$	● ●	10	60	$\mu\text{V}$ $\mu\text{V}$ $\mu\text{V}$
		LT6010S8 $T_A = 0^\circ\text{C}$ to $70^\circ\text{C}$ $T_A = -40^\circ\text{C}$ to $85^\circ\text{C}$	● ●	20	85	$\mu\text{V}$ $\mu\text{V}$ $\mu\text{V}$
		LT6010ADD $T_A = 0^\circ\text{C}$ to $70^\circ\text{C}$ $T_A = -40^\circ\text{C}$ to $85^\circ\text{C}$	● ●	20	85	$\mu\text{V}$ $\mu\text{V}$ $\mu\text{V}$
		LT6010DD $T_A = 0^\circ\text{C}$ to $70^\circ\text{C}$ $T_A = -40^\circ\text{C}$ to $85^\circ\text{C}$	● ●	30	110	$\mu\text{V}$ $\mu\text{V}$ $\mu\text{V}$
$\Delta V_{\text{OS}}/\Delta T$	Input Offset Voltage Drift (Note 6)	LT6010AS8, LT6010S8	●	0.2	0.8	$\mu\text{V}/^\circ\text{C}$
		LT6010ADD, LT6010DD	●	0.2	1.3	$\mu\text{V}/^\circ\text{C}$
$I_{\text{OS}}$	Input Offset Current (Note 7)	LT6010AS8 $T_A = 0^\circ\text{C}$ to $70^\circ\text{C}$ $T_A = -40^\circ\text{C}$ to $85^\circ\text{C}$	● ●	20	110	pA pA pA
		LT6010S8 $T_A = 0^\circ\text{C}$ to $70^\circ\text{C}$ $T_A = -40^\circ\text{C}$ to $85^\circ\text{C}$	● ●	40	200	pA pA pA
		LT6010ADD $T_A = 0^\circ\text{C}$ to $70^\circ\text{C}$ $T_A = -40^\circ\text{C}$ to $85^\circ\text{C}$	● ●	20	200	pA pA pA

**ELECTRICAL CHARACTERISTICS** The ● denotes the specifications which apply over the full operating temperature range, otherwise specifications are at  $T_A = 25^\circ\text{C}$ .  $V_S = \pm 15\text{V}$ ,  $V_{CM} = 0\text{V}$ ,  $R_L$  to  $0\text{V}$ ;  $\text{SHDN} = -14.8\text{V}$ , unless otherwise specified. (Note 5)

SYMBOL	PARAMETER	CONDITIONS	MIN	TYP	MAX	UNITS
$I_{OS}$	Input Offset Current (Note 7)	LT6010DD		40	300	$\mu\text{A}$
		$T_A = 0^\circ\text{C}$ to $70^\circ\text{C}$	●		400	$\mu\text{A}$
		$T_A = -40^\circ\text{C}$ to $85^\circ\text{C}$	●		500	$\mu\text{A}$
$I_B$	Input Bias Current (Note 7)	LT6010AS8		20	$\pm 110$	$\mu\text{A}$
		$T_A = 0^\circ\text{C}$ to $70^\circ\text{C}$	●		$\pm 150$	$\mu\text{A}$
		$T_A = -40^\circ\text{C}$ to $85^\circ\text{C}$	●		$\pm 200$	$\mu\text{A}$
		LT6010S8		40	$\pm 200$	$\mu\text{A}$
		$T_A = 0^\circ\text{C}$ to $70^\circ\text{C}$	●		$\pm 300$	$\mu\text{A}$
		$T_A = -40^\circ\text{C}$ to $85^\circ\text{C}$	●		$\pm 400$	$\mu\text{A}$
		LT6010ADD		20	$\pm 200$	$\mu\text{A}$
		$T_A = 0^\circ\text{C}$ to $70^\circ\text{C}$	●		$\pm 300$	$\mu\text{A}$
		$T_A = -40^\circ\text{C}$ to $85^\circ\text{C}$	●		$\pm 400$	$\mu\text{A}$
		LT6010DD		40	$\pm 300$	$\mu\text{A}$
		$T_A = 0^\circ\text{C}$ to $70^\circ\text{C}$	●		$\pm 400$	$\mu\text{A}$
		$T_A = -40^\circ\text{C}$ to $85^\circ\text{C}$	●		$\pm 500$	$\mu\text{A}$
	Input Noise Voltage	0.1Hz to 10Hz		400		$\text{nV}_{\text{p-p}}$
$e_n$	Input Noise Voltage Density	$f = 1\text{kHz}$		13		$\text{nV}/\sqrt{\text{Hz}}$
$i_n$	Input Noise Current Density	$f = 1\text{kHz}$		0.1		$\text{pA}/\sqrt{\text{Hz}}$
$R_{IN}$	Input Resistance	Common Mode, $V_{CM} = \pm 13.5\text{V}$	50	400		$\text{G}\Omega$
		Differential		20		$\text{M}\Omega$
$C_{IN}$	Input Capacitance			4		$\text{pF}$
$V_{CM}$	Input Voltage Range	Guaranteed by CMRR	● $\pm 13.5$	$\pm 14$		V
CMRR	Common Mode Rejection Ratio	$V_{CM} = -13.5\text{V}$ to $13.5\text{V}$	● 115	135		$\text{dB}$
			● 112			$\text{dB}$
	Minimum Supply Voltage	Guaranteed by PSRR	●	$\pm 1.2$	$\pm 1.35$	V
PSRR	Power Supply Rejection Ratio	$V_S = \pm 1.35\text{V}$ to $\pm 18\text{V}$	● 112	135		$\text{dB}$
$A_{VOL}$	Large-Signal Voltage Gain	$R_L = 10\text{k}$ , $V_{OUT} = -13.5\text{V}$ to $13.5\text{V}$	● 1000	2000		$\text{V}/\text{mV}$
		$R_L = 5\text{k}$ , $V_{OUT} = -13.5\text{V}$ to $13.5\text{V}$	● 600			$\text{V}/\text{mV}$
			● 500	1500		$\text{V}/\text{mV}$
			● 300			$\text{V}/\text{mV}$
$V_{OUT}$	Maximum Output Swing (Positive, Referred to $V^+$ )	No Load, 50mV Overdrive	●	45	80	$\text{mV}$
			●		100	$\text{mV}$
	$I_{SOURCE} = 1\text{mA}$ , 50mV Overdrive		●	140	195	$\text{mV}$
			●		240	$\text{mV}$
Maximum Output Swing (Negative, Referred to $0\text{V}$ )	No Load, 50mV Overdrive	●	45	80	$\text{mV}$	
		●		100	$\text{mV}$	
	$I_{SINK} = 1\text{mA}$ , 50mV Overdrive		●	150	250	$\text{mV}$
		●		300	$\text{mV}$	
$I_{SC}$	Output Short-Circuit Current (Note 3)	$V_{OUT} = 0\text{V}$ , 1V Overdrive (Source)	● 10	15		$\text{mA}$
			● 5			$\text{mA}$
		$V_{OUT} = 0\text{V}$ , -1V Overdrive (Sink)	● 10	20		$\text{mA}$
			● 5			$\text{mA}$

## ELECTRICAL CHARACTERISTICS

The ● denotes the specifications which apply over the full operating temperature range, otherwise specifications are at  $T_A = 25^\circ\text{C}$ .  $V_S = \pm 15\text{V}$ ,  $V_{\text{CM}} = 0\text{V}$ ,  $R_L$  to  $0\text{V}$ ;  $\text{SHDN} = -14.8\text{V}$ , unless otherwise specified. (Note 5)

SYMBOL	PARAMETER	CONDITIONS	MIN	TYP	MAX	UNITS
SR	Slew Rate	$A_V = -10$ , $R_F = 50\text{k}$ , $R_G = 5\text{k}$ $T_A = 0^\circ\text{C}$ to $70^\circ\text{C}$ $T_A = -40^\circ\text{C}$ to $85^\circ\text{C}$	● 0.08	0.11		$\text{V}/\mu\text{s}$
			● 0.07			$\text{V}/\mu\text{s}$
			● 0.05			$\text{V}/\mu\text{s}$
GBW	Gain Bandwidth Product	$f = 10\text{kHz}$	● 275	350		$\text{kHz}$ $\text{kHz}$
$t_s$	Settling Time	$A_V = -1$ , $0.01\%$ , $V_{\text{OUT}} = 0\text{V}$ to $10\text{V}$		85		$\mu\text{s}$
$t_r$ , $t_f$	Rise Time, Fall Time	$A_V = 1$ , $10\%$ to $90\%$ , $0.1\text{V}$ Step		1		$\mu\text{s}$
$I_{\text{SHDN}}$	SHDN Pin Current	SHDN $\leq V^- + 0.2\text{V}$ (On)	●		0.25	$\mu\text{A}$
		SHDN = $V^- + 2.0\text{V}$ (Off)	●	15	25	$\mu\text{A}$
$t_{\text{SHDN}}$	SHDN Turn-On, Turn-Off Time	SHDN = $V^-$ (On) to $V^- + 2.0\text{V}$ (Off)		25		$\mu\text{s}$
		SHDN = $V^- + 2.0\text{V}$ (Off) to $V^-$ (On)		25		$\mu\text{s}$
$I_S$	Supply Current	SHDN $\leq V^- + 0.2\text{V}$ (On)	●	260	330	$\mu\text{A}$
		$T_A = 0^\circ\text{C}$ to $70^\circ\text{C}$	●		380	$\mu\text{A}$
		$T_A = -40^\circ\text{C}$ to $85^\circ\text{C}$	●		400	$\mu\text{A}$
		SHDN = $V^- + 2.0\text{V}$ (Off)		18	50	$\mu\text{A}$

**Note 1:** Absolute Maximum Ratings are those beyond which the life of the device may be impaired.

**Note 2:** The inputs are protected by back-to-back diodes and internal series resistors. If the differential input voltage exceeds  $10\text{V}$ , the input current must be limited to less than  $10\text{mA}$ .

**Note 3:** A heat sink may be required to keep the junction temperature below absolute maximum ratings.

**Note 4:** Both the LT6010C and LT6010I are guaranteed functional over the operating temperature range of  $-40^\circ\text{C}$  to  $85^\circ\text{C}$ .

**Note 5:** The LT6010C is guaranteed to meet the specified performance

from  $0^\circ\text{C}$  to  $70^\circ\text{C}$  and is designed, characterized and expected to meet specified performance from  $-40^\circ\text{C}$  to  $85^\circ\text{C}$  but is not tested or QA sampled at these temperatures. The LT6010I is guaranteed to meet specified performance from  $-40^\circ\text{C}$  to  $85^\circ\text{C}$ .

**Note 6:** This parameter is not 100% tested.

**Note 7:** The specifications for  $V_{\text{OS}}$ ,  $I_B$  and  $I_{\text{OS}}$  depend on the grade and on the package. The following table clarifies the notations used in the specification table:

	Standard Grade	A Grade
S8 Package	LT6010S8	LT6010AS8
DFN Package	LT6010DD	LT6010ADD

## TYPICAL PERFORMANCE CHARACTERISTICS

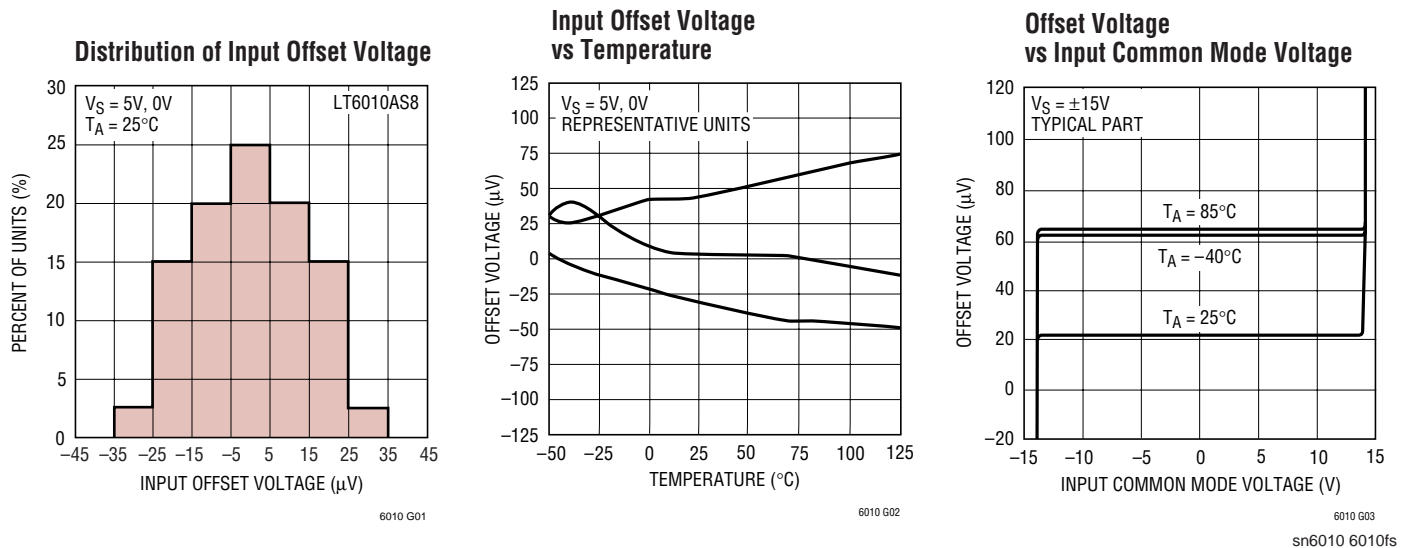

# TYPICAL PERFORMANCE CHARACTERISTICS

**Input Bias Current vs Temperature**

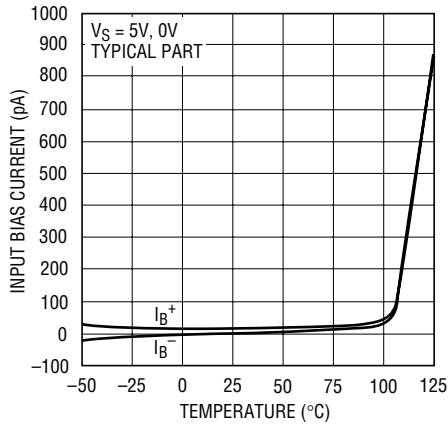

6010 G04

**Input Bias Current vs Input Common Mode Voltage**

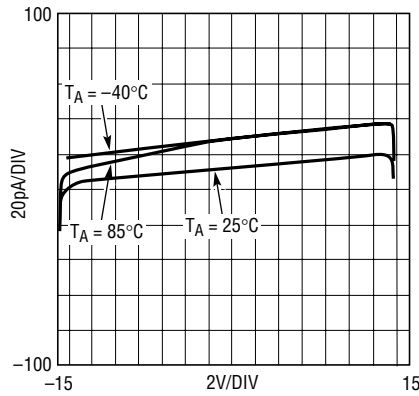

6010 G05

**e<sub>n</sub>, i<sub>n</sub> vs Frequency**

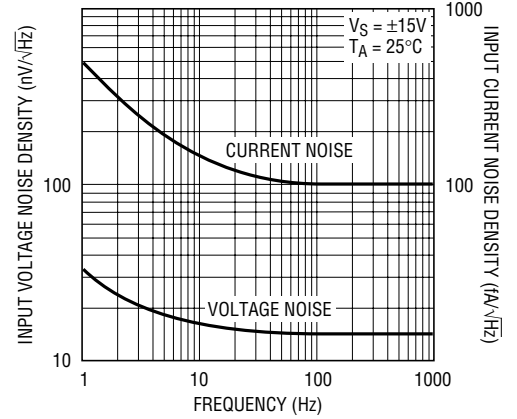

6010 G06

**Total Input Noise vs Source Resistance**

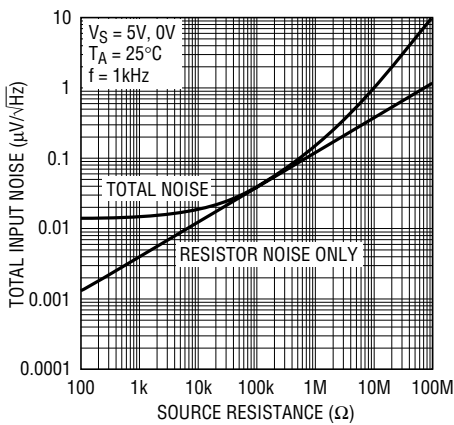

6010 G07

**0.1Hz to 10Hz Noise**

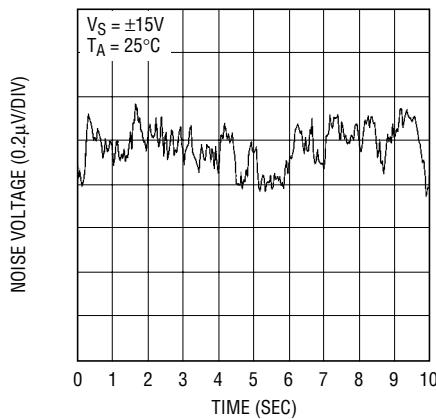

6010 G08

**0.01Hz to 1Hz Noise**

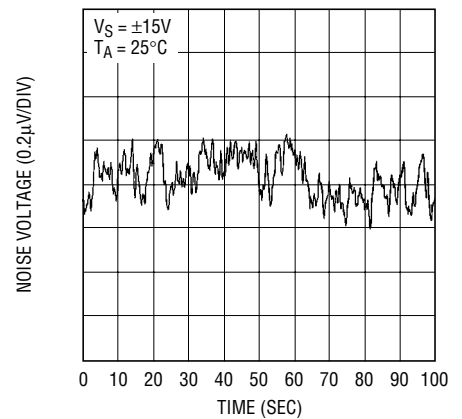

6010 G09

**Output Voltage Swing vs Temperature**

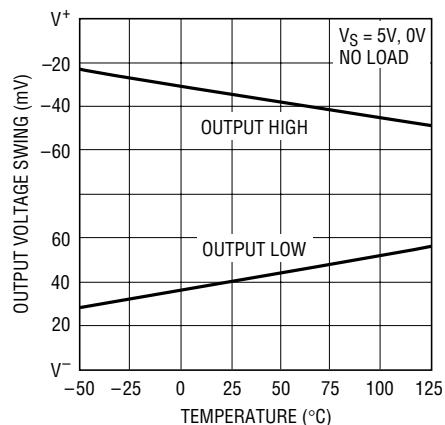

6010 G10

**Output Saturation Voltage vs Load Current (Output High)**

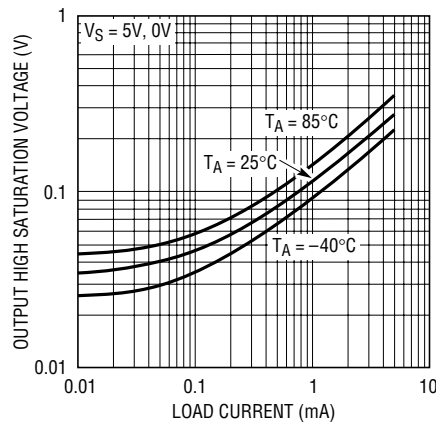

6010 G11

**Output Saturation Voltage vs Load Current (Output Low)**

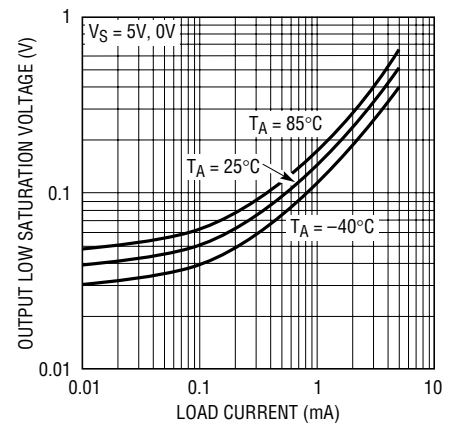

6010 G12

# TYPICAL PERFORMANCE CHARACTERISTICS

Supply Current vs Supply Voltage

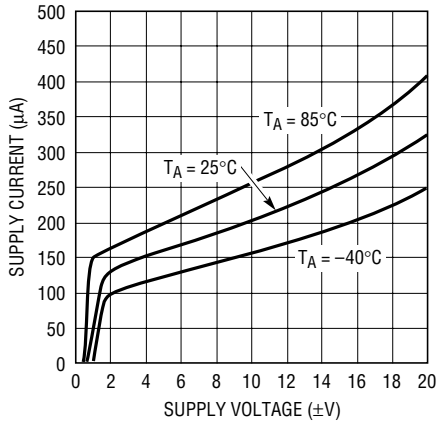

6010 G13

Warm-Up Drift

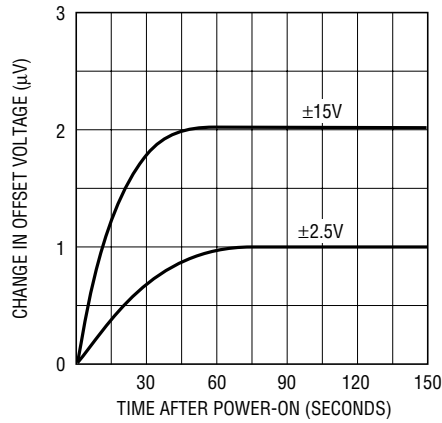

6010 G14

THD + Noise vs Frequency

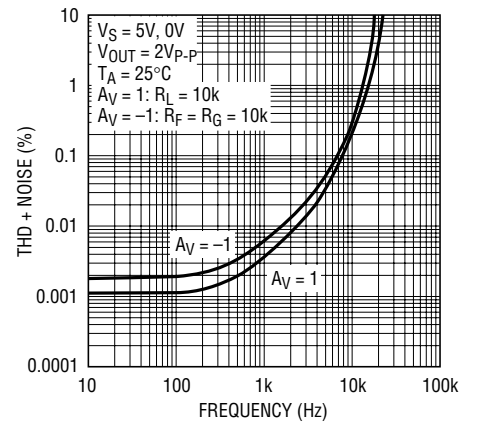

6010 G15

THD + Noise vs Frequency

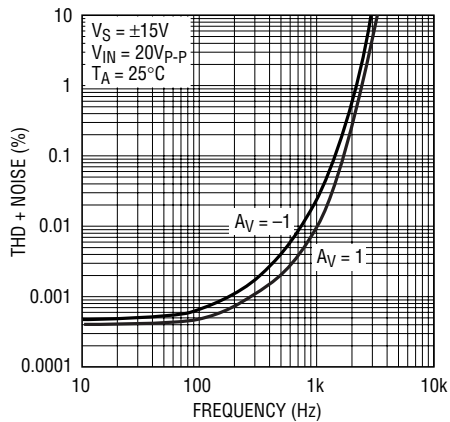

6010 G16

Settling Time vs Output Step

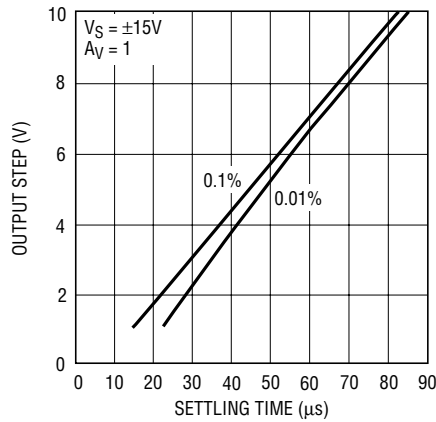

6010 G17

Settling Time vs Output Step

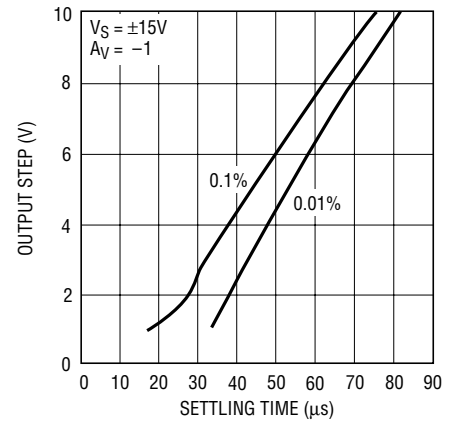

6010 G18

CMRR vs Frequency

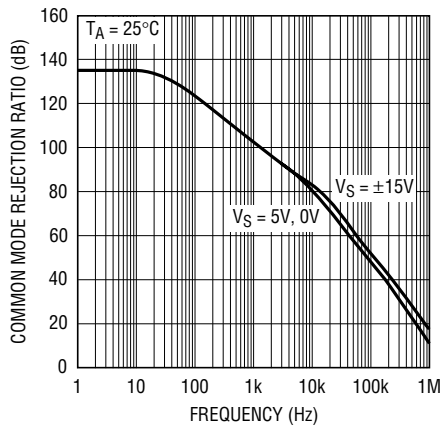

6010 G20

PSRR vs Frequency

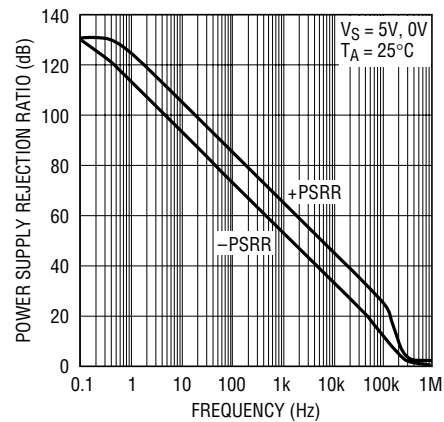

6010 G21

# TYPICAL PERFORMANCE CHARACTERISTICS

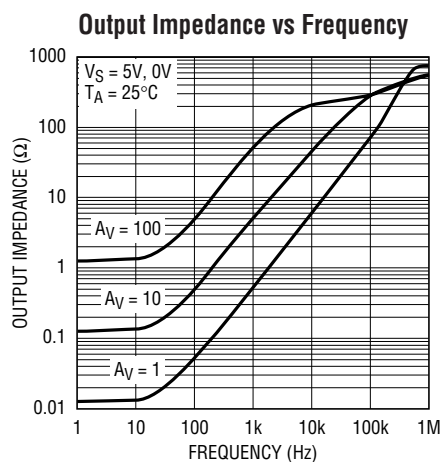

6010 G22

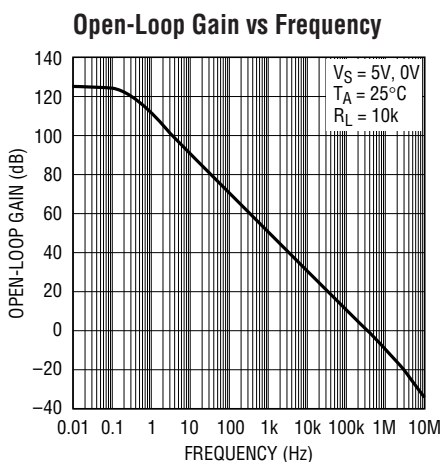

6010 G23

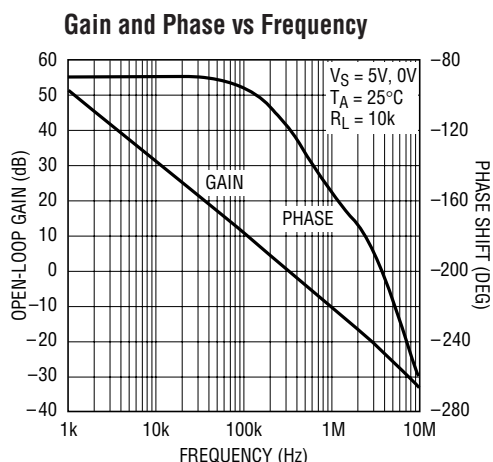

6010 G24

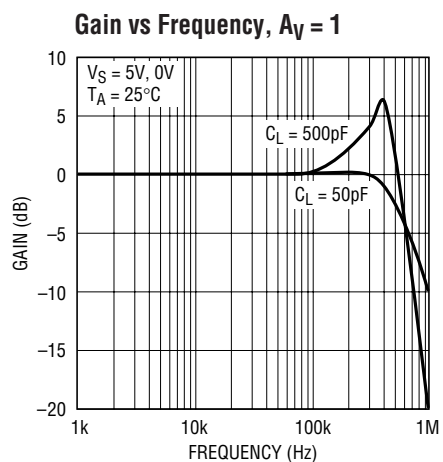

6010 G25

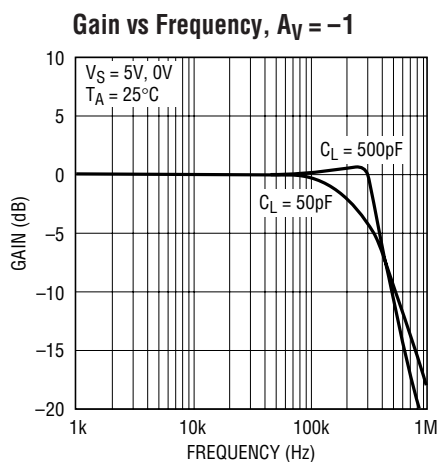

6010 G26

### Supply Current in Shutdown Mode vs Temperature

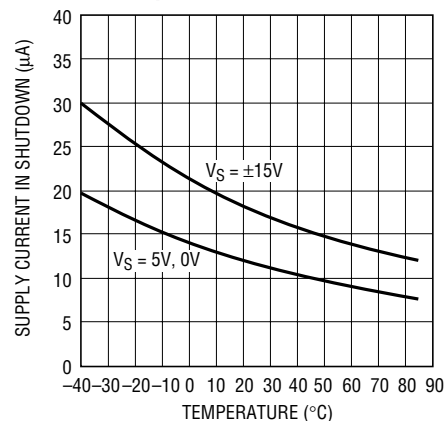

6010 G30

### Small-Signal Transient Response

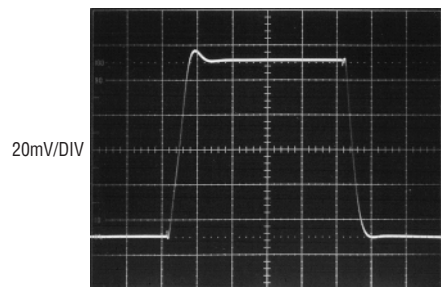

6011 G27

### Large-Signal Transient Response

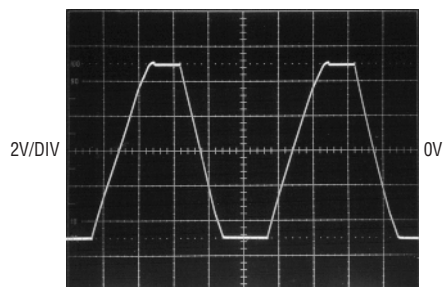

6011 G28

### Rail-to-Rail Output Swing

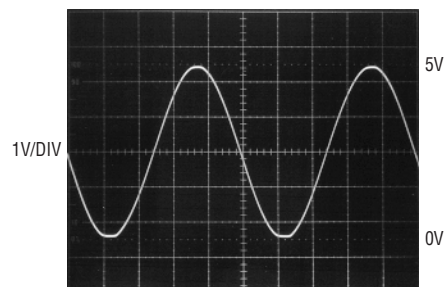

6011 G29

## APPLICATIONS INFORMATION

### Preserving Input Precision

Preserving the input accuracy of the LT6010 requires that the applications circuit and PC board layout do not introduce errors comparable to or greater than the 20 $\mu$ V typical offset of the amplifier. Temperature differentials across the input connections can generate thermocouple voltages of 10's of microvolts, so the connections to the input leads should be short, close together, and away from heat dissipating components. Air currents across the board can also generate temperature differentials.

The extremely low input bias currents (20pA typical) allow high accuracy to be maintained with high impedance sources and feedback resistors. The LT6010 low input bias currents are obtained by a cancellation circuit on-chip. The input bias currents are permanently trimmed at wafer testing to a low level. Do not try to balance the input resistances in each input lead; instead, keep the resistance at either input as low as possible for maximum accuracy.

Leakage currents on the PC board can be higher than the LT6010's input bias current. For example, 10G $\Omega$  of leakage between a 15V supply lead and an input lead will generate 1.5nA! Surround the input leads by a guard ring, driven to the same potential as the input common mode, to avoid excessive leakage in high impedance applications.

### Input Protection

The LT6010 features on-chip back-to-back diodes between the input devices, along with 500 $\Omega$  resistors in series with either input. This internal protection limits the input current to approximately 10mA (the maximum

allowed) for a 10V differential input voltage. Use additional external series resistors to limit the input current to 10mA in applications where differential inputs of more than 10V are expected. For example, a 1k resistor in series with each input provides protection against 30V differential voltage.

### Input Common Mode Range

The LT6010 output is able to swing nearly to each power supply rail (rail-to-rail out), but the input stage is limited to operating between  $V^- + 1V$  and  $V^+ - 1.2V$ . Exceeding this common mode range will cause the gain to drop to zero, however no phase reversal will occur.

### Total Input Noise

The LT6010 amplifier contributes negligible noise to the system when driven by sensors (sources) with impedance between 20k $\Omega$  and 1M $\Omega$ . Throughout this range, total input noise is dominated by the 4kTR<sub>S</sub> noise of the source. If the source impedance is less than 20k $\Omega$ , the input voltage noise of the amplifier starts to contribute with a minimum noise of 14nV/ $\sqrt{\text{Hz}}$  for very low source impedance. If the source impedance is more than 1M $\Omega$ , the input current noise of the amplifier, multiplied by this high impedance, starts to contribute and eventually dominate. Total input noise spectral density can be calculated as:

$$v_{n(\text{TOTAL})} = \sqrt{e_n^2 + 4kTR_S + (i_n R_S)^2}$$

where  $e_n = 14\text{nV}/\sqrt{\text{Hz}}$ ,  $i_n = 0.1\text{pA}/\sqrt{\text{Hz}}$  and  $R_S$  the total impedance at the input, including the source impedance.

## APPLICATIONS INFORMATION

### Offset Voltage Adjustment

The input offset voltage of the LT6010 and its drift with temperature are permanently trimmed at wafer testing to the low level as specified in the electrical characteristic. However, if further adjustment of  $V_{OS}$  is desired, nulling with a 50k potentiometer is possible and will not degrade drift with temperature. Trimming to a value other than zero

creates a drift of  $(V_{OS}/300\mu V) \mu V/^{\circ}C$ , e.g., if  $V_{OS}$  is adjusted to  $300\mu V$ , the change in drift will be  $1\mu V/^{\circ}C$ . The adjustment range with a 50k pot is approximately  $\pm 0.9mV$  (see Figures 1A and 1B). The sensitivity and resolution of the nulling can be improved by using a smaller pot in conjunction with fixed resistors. The configuration shown has an approximate nulling range of  $\pm 150\mu V$  (see Figures 2A and 2B).

#### Standard Adjustment

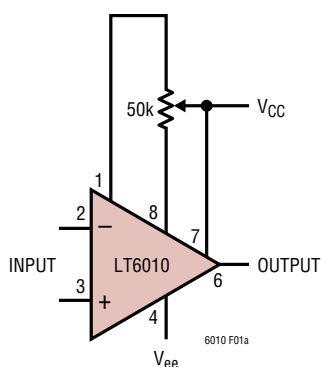

Figure 1A

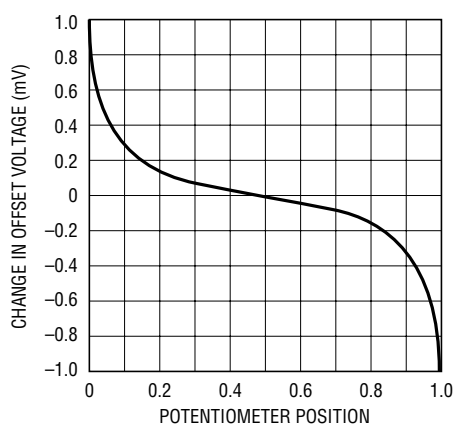

Figure 1B

#### Improved Sensitivity Adjustment

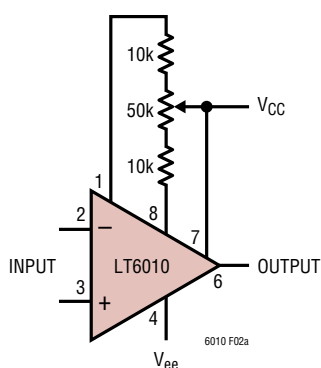

Figure 2A

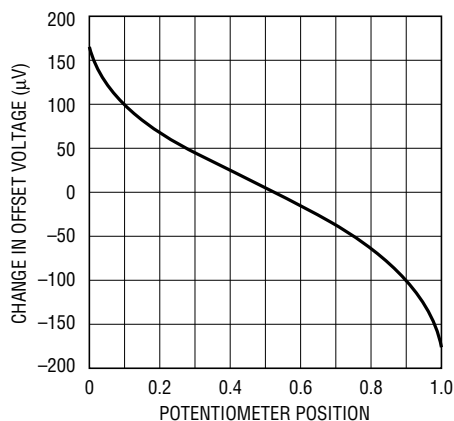

Figure 2B

## APPLICATIONS INFORMATION

### Shutdown

The LT6010 can be put into shutdown mode to conserve power. When the SHDN pin is biased at less than 0.2V above the negative supply, the part operates normally. When pulled 2V or more above  $V^-$ , the supply current drops to about 12 $\mu$ A, shutting down the op amp.

The output of the LT6010 op amp is not isolated from the inputs while in shutdown mode. Therefore, this shutdown feature cannot be used for multiplexing applications.

There is an internal 85k resistor at the SHDN pin. If the SHDN voltage source is more than 2V above the negative supply, an external series resistor can be placed between the source and SHDN pin to reduce SHDN pin current (see Figure 3). For an example of suggested values see Table 1. The resistors listed ensure that the voltage at the SHDN pin is 2V above the negative supply.

Table 1

$V_{SHDN}$ (V)	$R_{SHDN}$ (k $\Omega$ )
2	NONE
3	77k
4	153k
5	230k

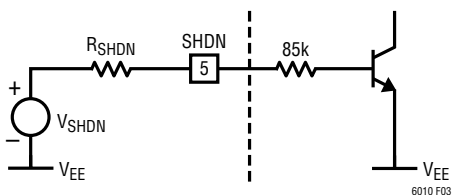

Figure 3

### Capacitive Loads

The LT6010 can drive capacitive loads up to 500pF in unity gain. The capacitive load driving capability increases as the amplifier is used in higher gain configurations. A small series resistance between the output and the load further increases the amount of capacitance that the amplifier can drive.

### Rail-to-Rail Operation

The LT6010 outputs can swing to within millivolts of either supply rail, but the inputs cannot. However, for most op amp configurations, the inputs need to swing less than the outputs. Figure 4 shows the basic op amp configurations, lists what happens to the op amp inputs and specifies whether or not the op amp must have rail-to-rail inputs. Select a rail-to-rail input op amp only when really necessary, because the input precision specifications are usually inferior.

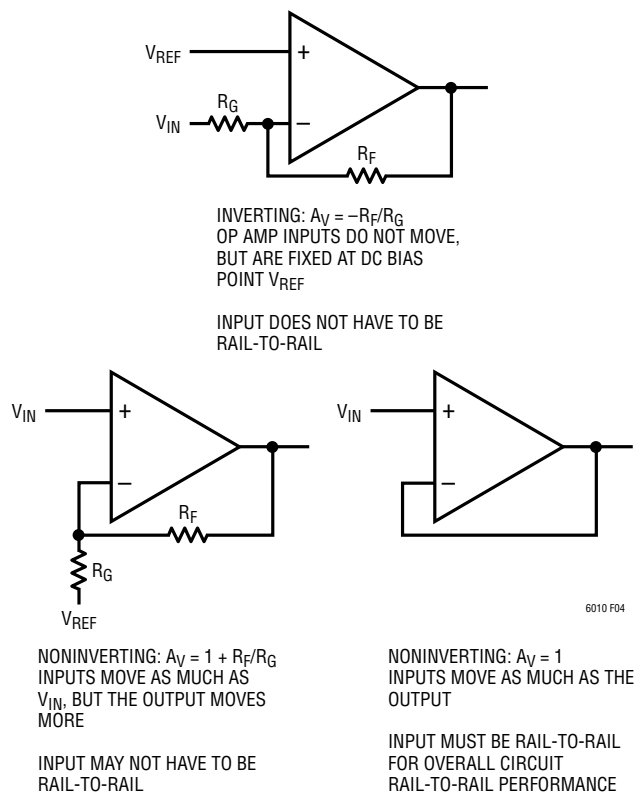
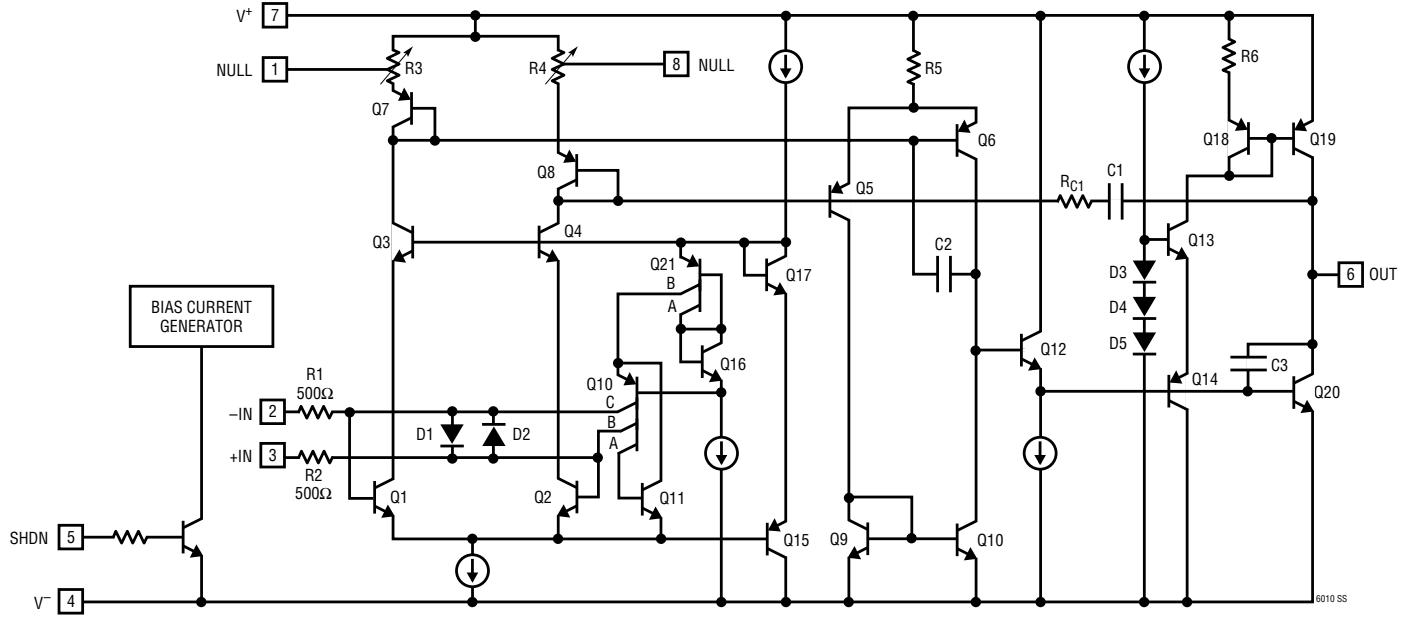

Figure 4. Some Op Amp Configurations Do Not Require Rail-to-Rail Inputs to Achieve Rail-to-Rail Outputs

SIMPLIFIED SCHEMATIC



**PACKAGE DESCRIPTION**

**DD Package**  
**8-Lead Plastic DFN (3mm × 3mm)**  
 (Reference LTC DWG # 05-08-1698)

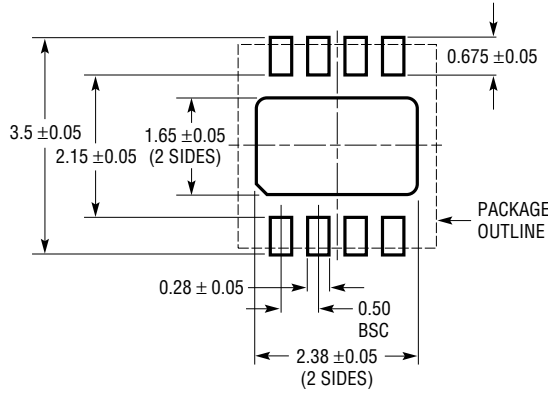

RECOMMENDED SOLDER PAD PITCH AND DIMENSIONS

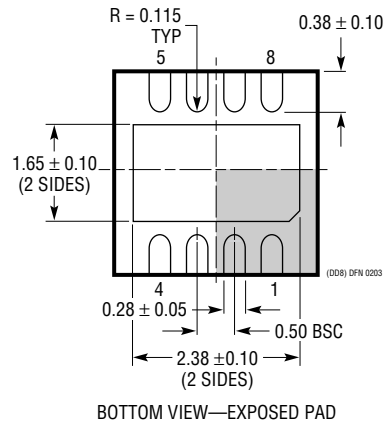
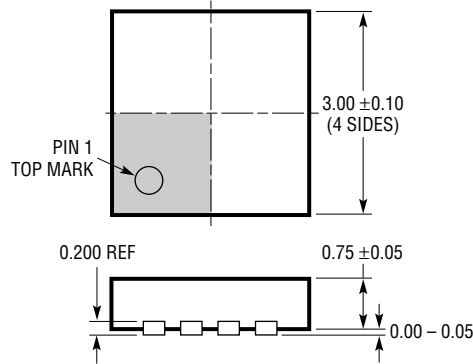

- NOTE:
1. DRAWING TO BE MADE A JEDEC PACKAGE OUTLINE M0-229 VARIATION OF (WEED-1)
  2. ALL DIMENSIONS ARE IN MILLIMETERS
  3. DIMENSIONS OF EXPOSED PAD ON BOTTOM OF PACKAGE DO NOT INCLUDE MOLD FLASH. MOLD FLASH, IF PRESENT, SHALL NOT EXCEED 0.15mm ON ANY SIDE
  4. EXPOSED PAD SHALL BE SOLDER PLATED

# PACKAGE DESCRIPTION

## S8 Package 8-Lead Plastic Small Outline (Narrow .150 Inch) (Reference LTC DWG # 05-08-1610)

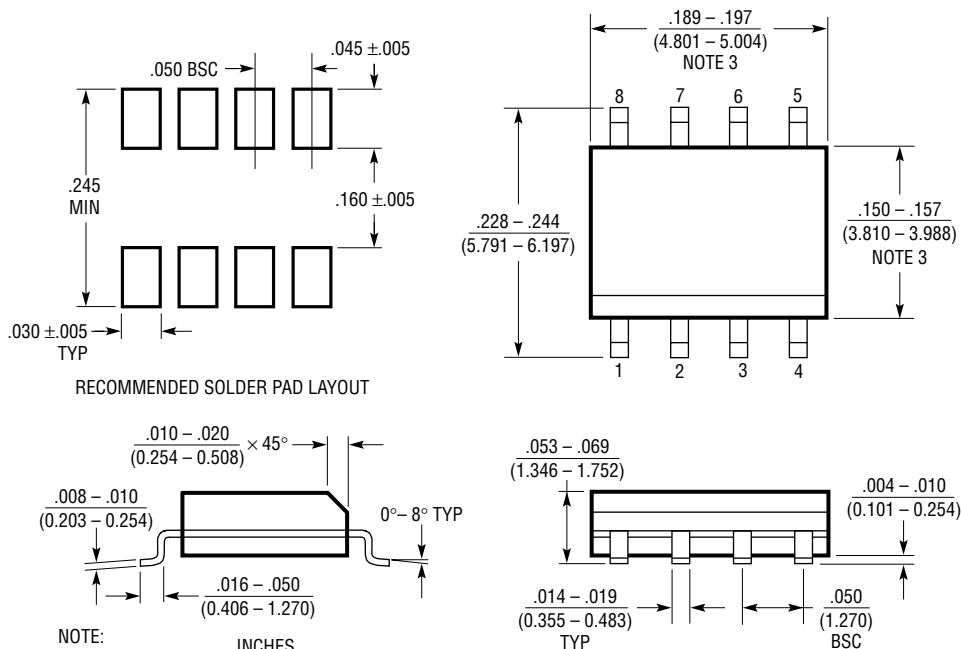

- NOTE:
1. DIMENSIONS IN  $\frac{\text{INCHES}}{\text{MILLIMETERS}}$
  2. DRAWING NOT TO SCALE
  3. THESE DIMENSIONS DO NOT INCLUDE MOLD FLASH OR PROTRUSIONS. MOLD FLASH OR PROTRUSIONS SHALL NOT EXCEED .006" (0.15mm)

S08 0303

## TYPICAL APPLICATION

Precision JFET Input Transimpedance Photodiode Amplifier

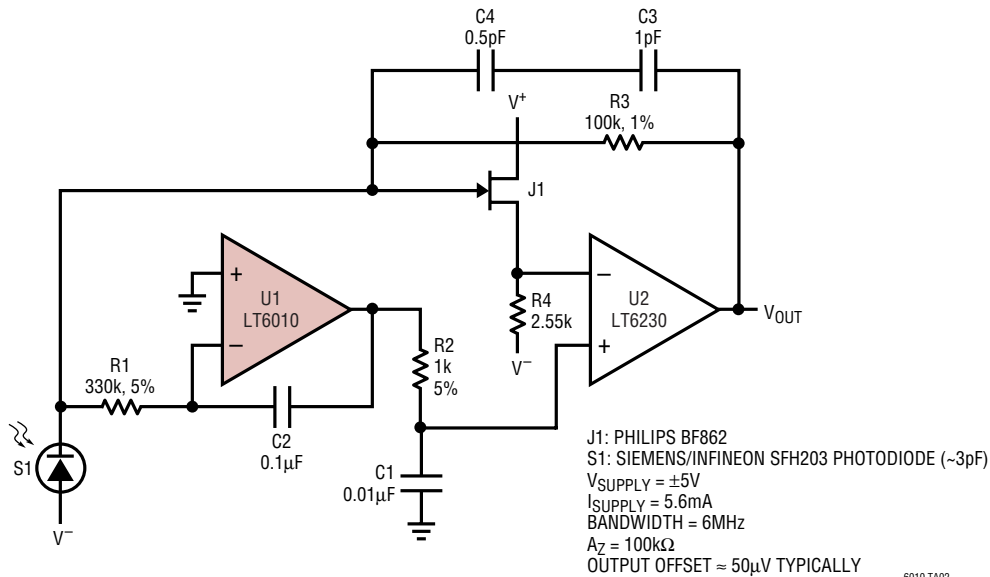

## RELATED PARTS

PART NUMBER	DESCRIPTION	COMMENTS
LT6011/6012	Dual/Quad Precision Op Amps	135µA, Rail-to-Rail Output
LT1001	Low Power, Picoamp Input Precision Op Amp	250pA Input Bias Current
LT1880	Rail-to-Rail Output, Picoamp Input Precision Op Amp	$C_{LOAD}$ up to 1000pF

## Looking for pricing, stock, or lifecycle information?

Click below to explore more details on WIN SOURCE:

- ⊖ [View LT6010ACS8#TRPBF on WIN SOURCE](#)
- ⊖ [Analog Devices Inc. Information](#)

## Optimize Your Supply Chain with WIN SOURCE Solutions

- ✓ Global Sourcing Solution
- ✓ Obsolete Management
- ✓ Cost Control Management
- ✓ Shortage Management
- ✓ Alternative Solution
- ✓ Excess Inventory Management