



THE DATASHEET OF LMR321G-GTR



Operational Amplifiers Series

Ground Sense Low Power General Purpose Operational Amplifiers



LMR321G, LMR358xxx, LMR324xxx

● **General Description**

LMR321, LMR358 and LMR324 are single, dual and quad low voltage operational amplifier with output full swing.

LMR321, LMR358 and LMR324 are the most effective solutions for applications where low supply current consumption and low voltage operation.

● **Features**

- Operable with low voltage
- Input Ground Sense, Output Full Swing
- High open loop voltage gain
- Low supply current
- Low input offset voltage

● **Packages**

	W(Typ.) x D(Typ.) x H(Max.)
SSOP5	2.90mm x 2.80mm x 1.25mm
SOP8	5.00mm x 6.20mm x 1.71mm
SOP-J8	4.90mm x 6.00mm x 1.65mm
SSOP-B8	3.00mm x 6.40mm x 1.35mm
TSSOP-B8	3.00mm x 6.40mm x 1.20mm
MSOP8	2.90mm x 4.00mm x 0.90mm
TSSOP-B8J	3.00mm x 4.90mm x 1.10mm
SOP14	8.70mm x 6.20mm x 1.71mm
SOP-J14	8.65mm x 6.00mm x 1.65mm
SSOP-B14	5.00mm x 6.40mm x 1.35mm
TSSOP-B14J	5.00mm x 6.40mm x 1.20mm

● **Applications**

- Portable equipment
- Low voltage application
- Active filter

● **Key Specifications**

- Operable with low voltage (single supply): +2.7V to +5.5V
- Low Supply Current:

LMR321	130µA(Typ.)
LMR358	210µA(Typ.)
LMR324	410µA(Typ.)
- High Slew Rate: 1.0V/µs(Typ.)
- Wide Temperature Range: -40°C to +85°C
- Low Input Offset Current: 5nA (Typ.)
- Low Input Bias Current: 15nA (Typ.)

● **Simplified schematic**

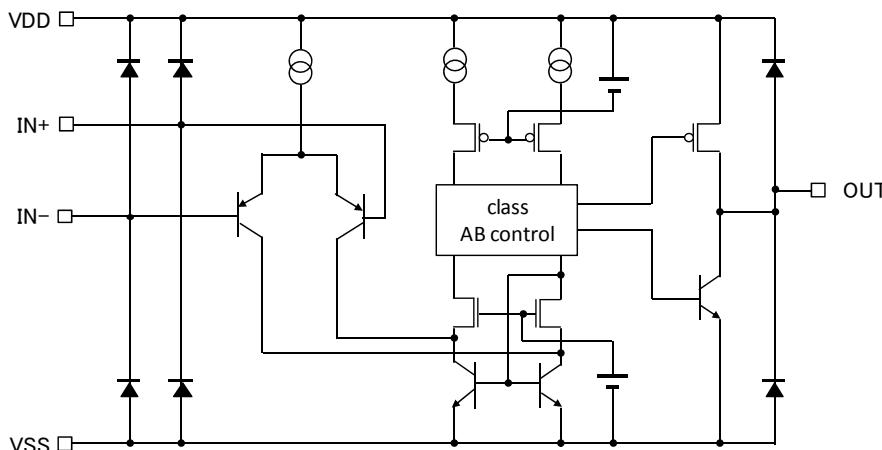
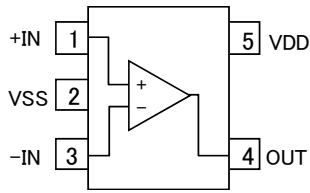

Figure 1. Simplified schematic

○Product structure : Silicon monolithic integrated circuit ○This product is not designed protection against radioactive rays.

●Pin Configuration

SSOP5



Pin No.	Symbol
1	+IN
2	VSS
3	-IN
4	OUT
5	VDD

SOP8, SOP-J8, SSOP-B8, TSSOP-B8, MSOP8, TSSOP-B8J

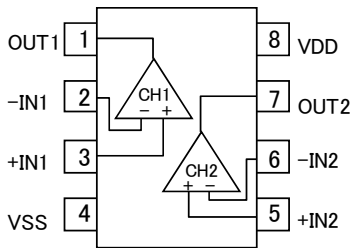

Pin No.	Symbol
1	OUT1
2	-IN1
3	+IN1
4	VSS
5	+IN2
6	-IN2
7	OUT2
8	VDD

SOP14, SOP-J14, SSOP-B14, TSSOP-B14J

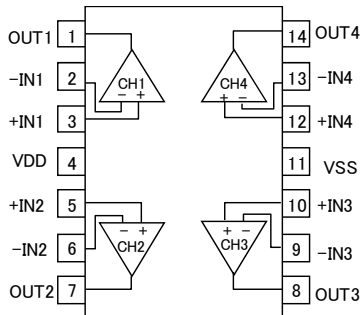

Pin No.	Symbol
1	OUT1
2	-IN1
3	+IN1
4	VDD
5	+IN2
6	-IN2
7	OUT2
8	OUT3
9	-IN3
10	+IN3
11	VSS
12	+IN4
13	-IN4
14	OUT4

Package					
SSOP5	SOP8	SOP-J8	SSOP-B8	TSSOP-B8	MSOP8
LMR321G	LMR358F	LMR358FJ	LMR358FV	LMR358FVT	LMR358FVM
Package					
TSSOP-B8J	SOP14	SOP-J14	SSOP-B14	TSSOP-B14J	-
LMR358FVJ	LMR324F	LMR324FJ	LMR324FV	LMR324FVJ	-

●Ordering Information

L M R 3 x x x x x - x x

Part Number LMR321G LMR358xxx LMR324xxx	Package G : SSOP5 F : SOP8, SOP14 FV : SSOP-B8 SSOP-B14 FVM : MSOP8 FJ : SOP-J8 SOP-J14 FVJ : TSSOP-B8J TSSOP-B14J FVT : TSSOP-B8	Packaging and forming specification E2: Embossed tape and reel (SOP8/SOP-J8/SSOP-B8/TSSOP-B8/ TSSOP-B8J/SOP14/SOP-J14/SSOP-B14 TSSOP-B14J) TR: Embossed tape and reel (SSOP5/MSOP8)
--	---	---

●Line-up

Topr	Input type	VDD (Min.)	Supply Current (Typ.)	Input Offset Voltage (Max.)	Package		Orderable Part Number
-40°C to + 85°C	Ground Sense	2.7V	130µA	±4mV	SSOP5	Reel of 3000	LMR321G-TR
			210µA	±5mV	SOP8	Reel of 2500	LMR358F-E2
					MSOP8	Reel of 3000	LMR358FVM-TR
					SOP-J8	Reel of 2500	LMR358FJ-E2
					SSOP-B8	Reel of 2500	LMR358FV-E2
					TSSOP-B8	Reel of 3000	LMR358FVT-E2
					TSSOP-B8J	Reel of 2500	LMR358FVJ-E2
			410µA	±9mV	SOP14	Reel of 2500	LMR324F-E2
					SOP-J14	Reel of 2500	LMR324FJ-E2
					SSOP-B14	Reel of 2500	LMR324FV-E2
					TSSOP-B14J	Reel of 2500	LMR324FVJ-E2

● Absolute Maximum Ratings (Ta=25°C)

Parameter	Symbol	Rating			Unit	
		LMR321G	LMR358	LMR324		
Supply Voltage	VDD-VSS	+7			V	
Power dissipation	Pd	SSOP5	675 ^{+1*9}	-	-	mW
		SOP-J8	-	675 ^{+1*9}	-	
		SOP8	-	690 ^{+2*9}	-	
		SSOP-B8	-	625 ^{+3*9}	-	
		TSSOP-B8	-	625 ^{+3*9}	-	
		MSOP8	-	587 ^{+4*9}	-	
		TSSOP-B8J	-	587 ^{+4*9}	-	
		SOP-J14	-	-	1025 ^{+5*9}	
		SSOP-B14	-	-	875 ^{+6*9}	
		TSSOP-B14J	-	-	850 ^{+7*9}	
SOP14	-	-	562 ^{+8*9}			
Differential Input Voltage ^{*10}	Vid	VDD - VSS			V	
Input Common-mode Voltage Range	Vicm	(VSS-0.3) to (VDD+0.3)			V	
Operable with low voltage	Vopr	+2.7 to +5.5			V	
Operating Temperature	Topr	-40 to +85			°C	
Storage Temperature	Tstg	-55 to +150			°C	
Maximum Junction Temperature	Tjmax	+150			°C	

Note: Absolute maximum rating item indicates the condition which must not be exceeded.

Application of voltage in excess of absolute maximum rating or use out absolute maximum rated temperature environment may cause deterioration of characteristics.

*1 To use at temperature above Ta=25°C reduce 5.4mW/°C.

*2 To use at temperature above Ta=25°C reduce 5.52mW/°C.

*3 To use at temperature above Ta=25°C reduce 5mW/°C.

*4 To use at temperature above Ta=25°C reduce 4.7mW/°C.

*5 To use at temperature above Ta=25°C reduce 8.2mW/°C.

*6 To use at temperature above Ta=25°C reduce 7mW/°C.

*7 To use at temperature above Ta=25°C reduce 6.8mW/°C.

*8 To use at temperature above Ta=25°C reduce 4.5mW/°C.

*9 Mounted on a glass epoxy PCB(70mm×70mm×1.6mm).

*10 The voltage difference between inverting input and non-inverting input is the differential input voltage. Then input terminal voltage is set to more than VSS.

● Electrical Characteristics

OLMR321 (Unless otherwise specified VDD=+5V, VSS=0V)

Parameter	Symbol	Temperature Range	Limits			Unit	Condition
			Min.	Typ.	Max.		
Input Offset Voltage ^{*11}	Vio	25°C	-	0.1	4	mV	VDD=2.7V to 5V
		Full range	-	-	5		
Input Offset Voltage drift	$\Delta V_{io}/\Delta T$	25°C	-	3	-	$\mu V/^\circ C$	-
Input Offset Current ^{*11}	Iio	25°C	-	5	50	nA	-
Input Bias Current ^{*11}	Ib	25°C	-	15	100	nA	-
Supply Current ^{*12}	IDD	25°C	-	107	180	μA	VDD=2.7V, Av=0dB VIN=0.95V
		Full range	-	-	260		
		25°C	-	130	200		VDD=5V, Av=0dB VIN=2.1V
		Full range	-	-	280		
Maximum Output Voltage(High)	VOH	25°C	VDD-0.1	VDD-0.04	-	V	RL=2k Ω to 2.5V
Maximum Output Voltage(Low)	VOL	25°C	-	VSS+0.08	VSS+0.16	V	RL=2k Ω to 2.5V
Large Signal Voltage Gain	Av	25°C	78	110	-	dB	RL=2k Ω
Input Common-mode Voltage Range	Vicm	25°C	0	-	4.2	V	VSS to VDD-0.8V
Common-mode Rejection Ratio	CMRR	25°C	65	90	-	dB	-
Power Supply Rejection Ratio	PSRR	25°C	65	90	-	dB	-
Output Source Current ^{*13}	Isource	25°C	6	13	-	mA	OUT=VDD-0.4V
			-	70	-		OUT=0V, short current
Output Sink Current ^{*13}	Isink	25°C	30	60	-	mA	OUT=VSS+0.4V
			-	180	-		OUT=5V, short current
Slew Rate	SR	25°C	-	1.0	-	V/ μs	CL=25pF
Unity Band width	f _T	25°C	-	2	-	MHz	CL=25pF, Av=40dB
			-	1	-		CL=200pF
Gain Band Width	GBW	25°C	-	3	-	MHz	f=100kHz
Phase Margin	θ	25°C	-	45	-	deg	CL=25pF, Av=40dB
Gain Margin	GM	25°C	-	10	-	dB	-
Input Referred Noise Voltage	Vn	25°C	-	5.5	-	μV_{rms}	Av=40dB
			-	39	-	nV/(Hz) ^{1/2}	Av=40dB, f=1kHz
Total Harmonic Distortion + Noise	THD+N	25°C	-	0.0015	-	%	OUT=0.4V _{P-P} f=1kHz

*11 Absolute value

*12 Full range: LMR321: Ta=-40°C to +85°C

*13 Under the high temperature environment, consider the power dissipation of IC when selecting the output current.

When the terminal short circuits are continuously output, the output current is reduced to climb to the temperature inside IC.

OLMR358 (Unless otherwise specified VDD=+5V, VSS=0V)

Parameter	Symbol	Temperature Range	Limits			Unit	Condition
			Min.	Typ.	Max.		
Input Offset Voltage ^{*14}	Vio	25°C	-	0.1	5	mV	VDD=2.7V to 5.0V
		Full range	-	-	5		
Input Offset Voltage drift	$\Delta V_{io}/\Delta T$	25°C	-	3	-	$\mu V/^\circ C$	-
Input Offset Current ^{*14}	Iio	25°C	-	5	50	nA	-
Input Bias Current ^{*14}	Ib	25°C	-	15	100	nA	-
Supply Current ^{*15}	IDD	25°C	-	210	360	μA	VDD=2.7V, Av=0dB VIN=0.95V
		Full range	-	-	520		
		25°C	-	210	380		VDD=5V, Av=0dB VIN=2.1V
		Full range	-	-	540		
Maximum Output Voltage(High)	VOH	25°C	VDD-0.1	VDD-0.04	-	V	RL=2k Ω to 2.5V
Maximum Output Voltage(Low)	VOL	25°C	-	VSS+0.08	VSS+0.16	V	RL=2k Ω to 2.5V
Large Signal Voltage Gain	Av	25°C	78	110	-	dB	RL=2k Ω
Input Common-mode Voltage Range	Vicm	25°C	0	-	4.2	V	VSS to VDD-0.8V
Common-mode Rejection Ratio	CMRR	25°C	65	90	-	dB	-
Power Supply Rejection Ratio	PSRR	25°C	65	90	-	dB	-
Output Source Current ^{*16}	Isource	25°C	6	13	-	mA	OUT=VDD-0.4V
			-	70	-		OUT=0V, short current
Output Sink Current ^{*16}	Isink	25°C	30	60	-	mA	OUT=VSS+0.4V
			-	180	-		OUT=5V, short current
Slew Rate	SR	25°C	-	1.0	-	V/ μs	CL=25pF
Unity Band Width	f _T	25°C	-	2	-	MHz	CL=25F, Av=40dB
			-	1	-		CL=200pF
Gain Band Width	GBW	25°C	-	3	-	MHz	f=100kHz
Phase Margin	θ	25°C	-	45	-	°	CL=25pF, Av=40dB
Gain Margin	GM	25°C	-	10	-	dB	-
Input Referred Noise Voltage	Vn	25°C	-	5.5	-	μV_{rms}	Av=40dB
			-	39	-		nV/(Hz) ^{1/2} Av=40dB, f=1kHz
Total Harmonic Distortion + Noise	THD+N	25°C	-	0.0015	-	%	OUT=0.4V _{P-P} f=1kHz
Channel Separation	CS	25°C	-	100	-	dB	Av=40dB

^{*14} Absolute value^{*15} Full range: LMR358: Ta=-40°C to +85°C^{*16} Under the high temperature environment, consider the power dissipation of IC when selecting the output current.
When the terminal short circuits are continuously output, the output current is reduced to climb to the temperature inside IC.

OLMR324 (Unless otherwise specified VDD=+5V, VSS=0V)

Parameter	Symbol	Temperature Range	Limits			Unit	Condition
			Min.	Typ.	Max.		
Input Offset Voltage ^{*17}	Vio	25°C	-	1.0	9	mV	VDD=2.7V to 5.0V
		Full range	-	-	9		
Input Offset Voltage drift	$\Delta V_{io}/\Delta T$	25°C	-	3	-	$\mu V/^\circ C$	-
Input Offset Current ^{*17}	Iio	25°C	-	5	50	nA	-
Input Bias Current ^{*17}	Ib	25°C	-	15	100	nA	-
Supply Current ^{*18}	IDD	25°C	-	410	720	μA	VDD=2.7V, Av=0dB VIN=0.95V
		Full range	-	-	880		
		25°C	-	410	800		VDD=5V, Av=0dB VIN=2.1V
		Full range	-	-	900		
Maximum Output Voltage(High)	VOH	25°C	VDD-0.1	VDD-0.04	-	V	RL=2k Ω to 2.5V
Maximum Output Voltage(Low)	VOL	25°C	-	VSS+0.08	VSS+0.16	V	RL=2k Ω to 2.5V
Large Signal Voltage Gain	Av	25°C	78	110	-	dB	RL=2k Ω
Input Common-mode Voltage Range	Vicm	25°C	0	-	4.2	V	VSS to VDD-0.8V
Common-mode Rejection Ratio	CMRR	25°C	65	90	-	dB	-
Power Supply Rejection Ratio	PSRR	25°C	65	90	-	dB	-
Output Source Current ^{*19}	Isource	25°C	6	13	-	mA	OUT=VDD-0.4V
			-	70	-		OUT=0V, short current
Output Sink Current ^{*19}	Isink	25°C	30	60	-	mA	OUT=VSS+0.4V
			-	180	-		OUT=5V, short current
Slew Rate	SR	25°C	-	1.0	-	V/ μs	CL=25pF
Unity Gain Frequency	f _T	25°C	-	2	-	MHz	CL=25pF, Av=40dB
			-	1	-		CL=200pF
Gain Band width	GBW	25°C	-	3	-	MHz	f=100kHz
Phase Margin	θ	25°C	-	45	-	deg	CL=25pF, Av=40dB
Gain Margin	GM	25°C	-	10	-	dB	-
Input Referred Noise Voltage	Vn	25°C	-	5.5	-	μV_{rms}	Av=40dB
			-	39	-		nV/(Hz) ^{1/2} Av=40dB, f=1kHz
Total Harmonic Distortion + Noise	THD+N	25°C	-	0.0015	-	%	OUT=0.4V _{P-P} f=1kHz
Channel Separation	CS	25°C	-	100	-	dB	Av=40dB

*17 Absolute value

*18 Full range: LMR324: Ta=-40°C to +85°C

*19 Under the high temperature environment, consider the power dissipation of IC when selecting the output current.
When the terminal short circuits are continuously output, the output current is reduced to climb to the temperature inside IC.

Description of electrical characteristics

Described here are the terms of electric characteristics used in this datasheet. Items and symbols used are also shown. Note that item name and symbol and their meaning may differ from those on another manufacture's document or general document.

1. Absolute maximum ratings

Absolute maximum rating item indicates the condition which must not be exceeded. Application of voltage in excess of absolute maximum rating or use out of absolute maximum rated temperature environment may cause deterioration of characteristics.

1.1 Power supply voltage (VDD/VSS)

Indicates the maximum voltage that can be applied between the positive power supply terminal and negative power supply terminal without deterioration or destruction of characteristics of internal circuit.

1.2 Differential input voltage (Vid)

Indicates the maximum voltage that can be applied between non-inverting terminal and inverting terminal without deterioration and destruction of characteristics of IC.

1.3 Input common-mode voltage range (Vicm)

Indicates the maximum voltage that can be applied to non-inverting terminal and inverting terminal without deterioration or destruction of characteristics. Input common-mode voltage range of the maximum ratings not assures normal operation of IC. When normal Operation of IC is desired, the input common-mode voltage of characteristics item must be followed.

1.4 Power dissipation (Pd)

Indicates the power that can be consumed by specified mounted board at the ambient temperature 25°C(normal temperature). As for package product, Pd is determined by the temperature that can be permitted by IC chip in the package (maximum junction temperature) and thermal resistance of the package.

2. Electrical characteristics item

2.1 Input offset voltage (Vio)

Indicates the voltage difference between non-inverting terminal and inverting terminal. It can be translated into the input voltage difference required for setting the output voltage at 0 V.

2.2 Input offset voltage drift ($\Delta V_{io}/\Delta T$)

Denotes the ratio of the input offset voltage fluctuation to the ambient temperature fluctuation.

2.3 Input offset current (Iio)

Indicates the difference of input bias current between non-inverting terminal and inverting terminal.

2.4 Input bias current (Ib)

Indicates the current that flows into or out of the input terminal. It is defined by the average of input bias current at non-inverting terminal and input bias current at inverting terminal.

2.5 Circuit current (IDD)

Indicates the IC current that flows under specified conditions and no-load steady status.

2.6 Maximum Output Voltage(High) / Maximum Output Voltage(Low) (VOH/VOL)

Indicates the voltage range that can be output by the IC under specified load condition. It is typically divided into maximum output voltage High and low. Maximum output voltage high indicates the upper limit of output voltage. Maximum output voltage low indicates the lower limit.

2.7 Large signal voltage gain (Av)

Indicates the amplifying rate (gain) of output voltage against the voltage difference between non-inverting terminal and inverting terminal. It is normally the amplifying rate (gain) with reference to DC voltage.

$$A_v = (\text{Output voltage fluctuation}) / (\text{Input offset fluctuation})$$

2.8 Input common-mode voltage range (Vicm)

Indicates the input voltage range where IC operates normally.

2.9 Common-mode rejection ratio (CMRR)

Indicates the ratio of fluctuation of input offset voltage when in-phase input voltage is changed. It is normally the fluctuation of DC.

$$CMRR = (\text{Change of Input common-mode voltage}) / (\text{Input offset fluctuation})$$

2.10 Power supply rejection ratio (PSRR)

Indicates the ratio of fluctuation of input offset voltage when supply voltage is changed. It is normally the fluctuation of DC. PSRR= (Change of power supply voltage)/(Input offset fluctuation)

2.11 Output source current/ output sink current (Isource/Isink)

The maximum current that can be output under specific output conditions, it is divided into output source current and output sink current. The output source current indicates the current flowing out of the IC, and the output sink current the current flowing into the IC.

2.12 Channel separation (CS)

Indicates the fluctuation of output voltage with reference to the change of output voltage of driven channel.

2.13 Slew Rate (SR)

SR is a parameter that shows movement speed of operational amplifier. It indicates rate of variable output voltage as unit time.

2.14 Unity gain frequency (f_T)

Indicates a frequency where the voltage gain of Op-Amp is 1.

2.15 Gain Band Width (GBW)

Indicates to multiply by the frequency and the gain where the voltage gain decreases 6dB/octave.

2.16 Phase Margin (θ)

Indicates the margin of phase from 180 degree phase lag at unity gain frequency.

2.17 Gain Margin (GM)

Indicates the difference between 0dB and the gain where operational amplifier has 180 degree phase delay.

2.18 Total harmonic distortion + Noise (THD+N)

Indicates the fluctuation of input offset voltage or that of output voltage with reference to the change of output voltage of driven channel.

2.19 Input referred noise voltage (V_n)

Indicates a noise voltage generated inside the operational amplifier equivalent by ideal voltage source connected in series with input terminal.

● Typical Performance Curves

OLMR321

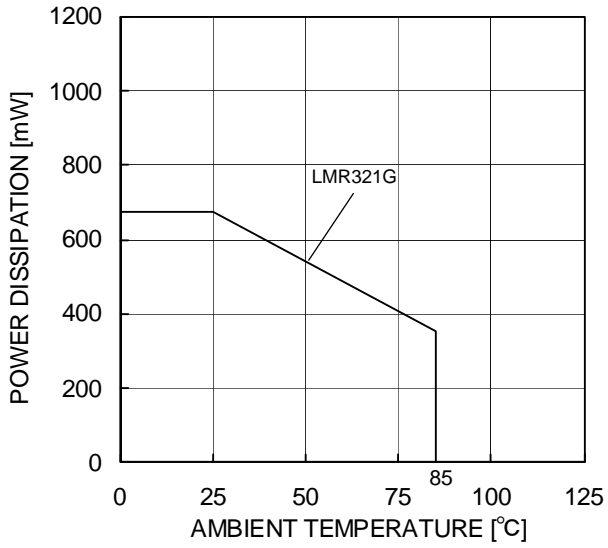

Figure 2.
Derating curve

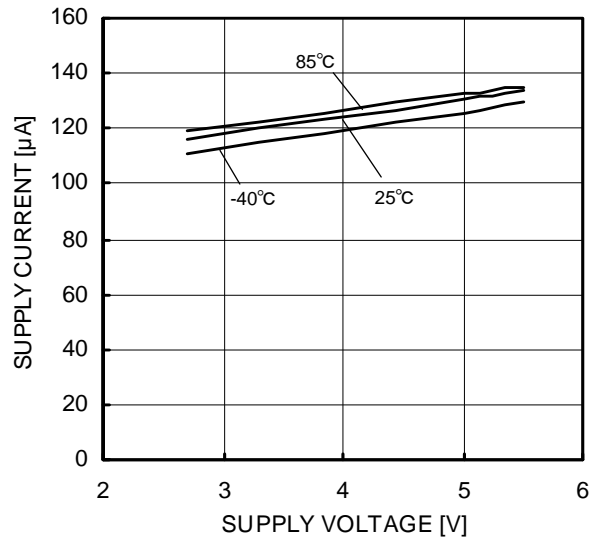

Figure 3.
Supply Current - Supply Voltage

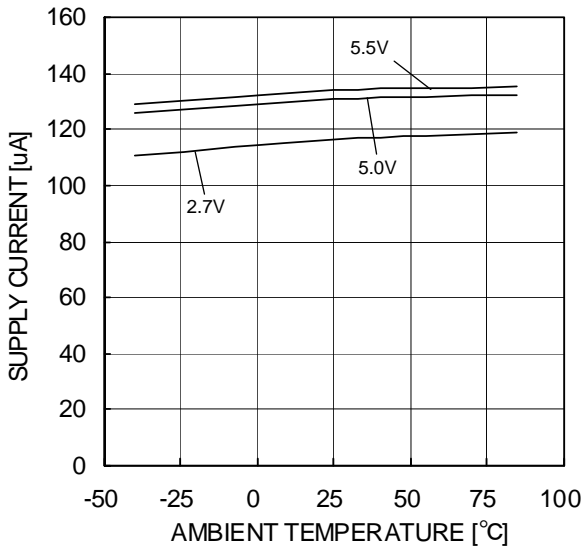

Figure 4.
Supply Current - Ambient Temperature

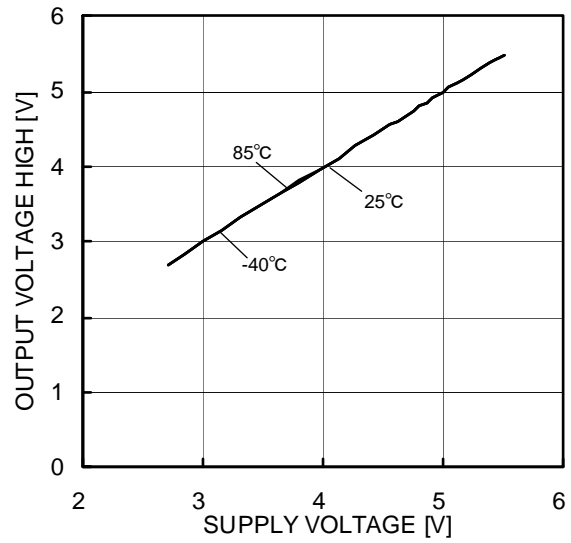

Figure 5.
Maximum Output Voltage(High)
- Supply Voltage
(RL=2kΩ)

(*)The data above is measurement value of typical sample, it is not guaranteed.

OLMR321

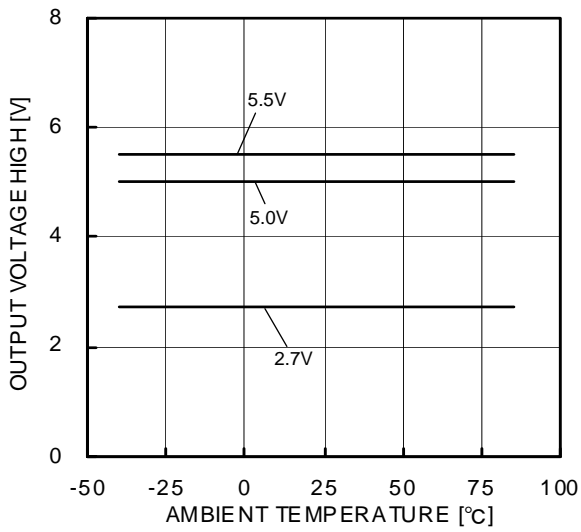

Figure 6.
Maximum Output Voltage(High)
– Ambient Temperature
(RL=2kΩ)

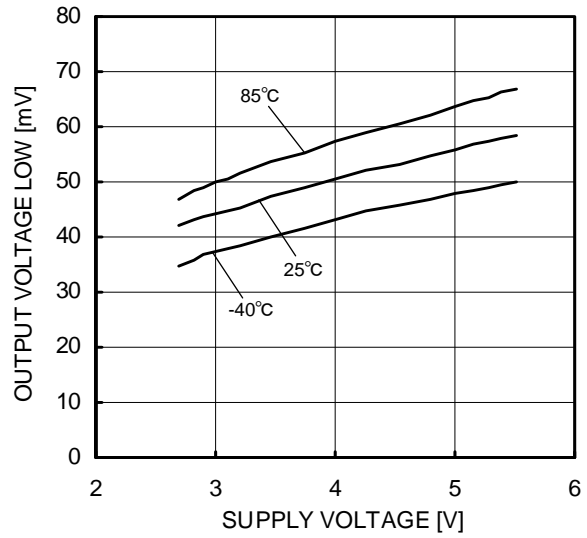

Figure 7.
Maximum Output Voltage(Low)
– Supply Voltage
(RL=2kΩ)

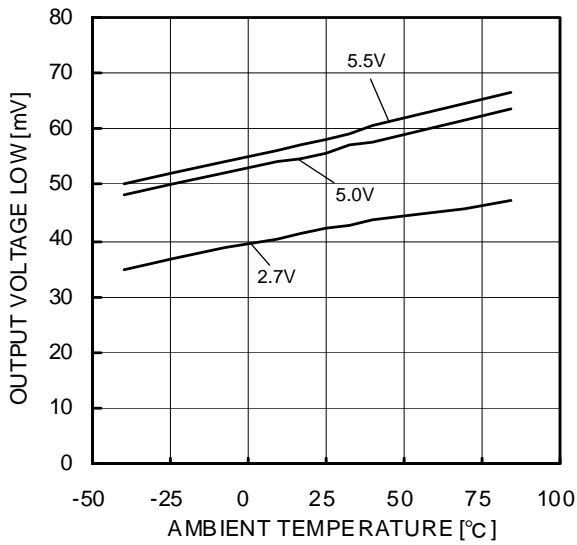

Figure 8.
Maximum Output Voltage(Low)
– Ambient Temperature
(RL=2kΩ)

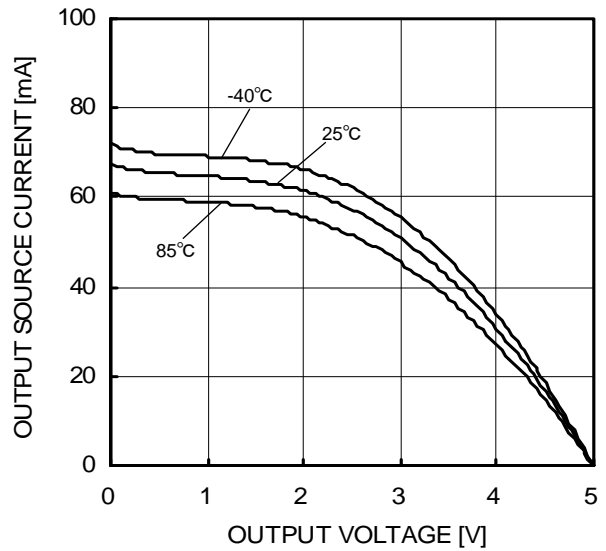

Figure 9.
Output Source Current – Output Voltage
(VDD=5V)

(*)The data above is measurement value of typical sample, it is not guaranteed.

OLMR321

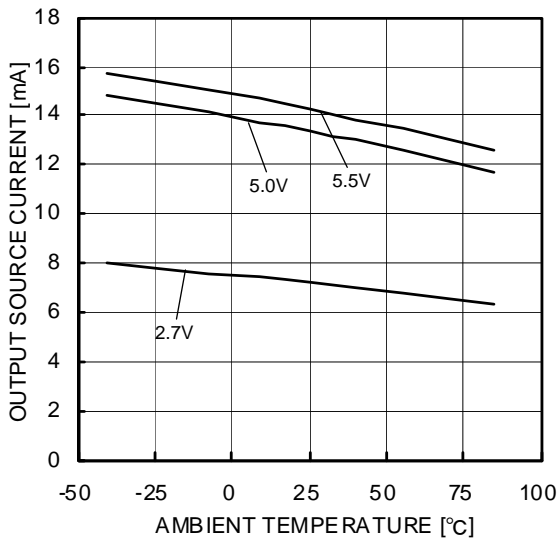

Figure 10.
Output Source Current – Ambient Temperature
(OUT=VDD-0.4V)

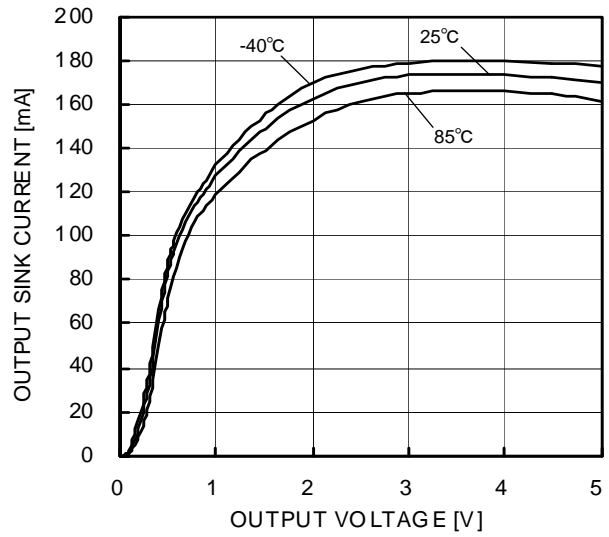

Figure 11.
Output Sink Current – Output Voltage
(VDD=5V)

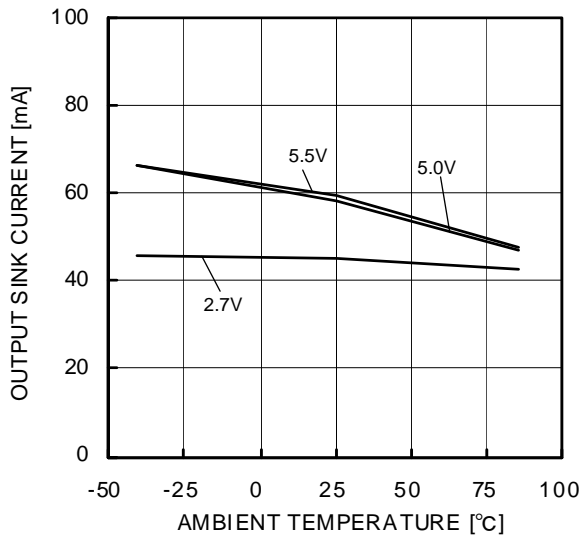

Figure 12.
Output Sink Current – Ambient Temperature
(OUT=VSS+0.4V)

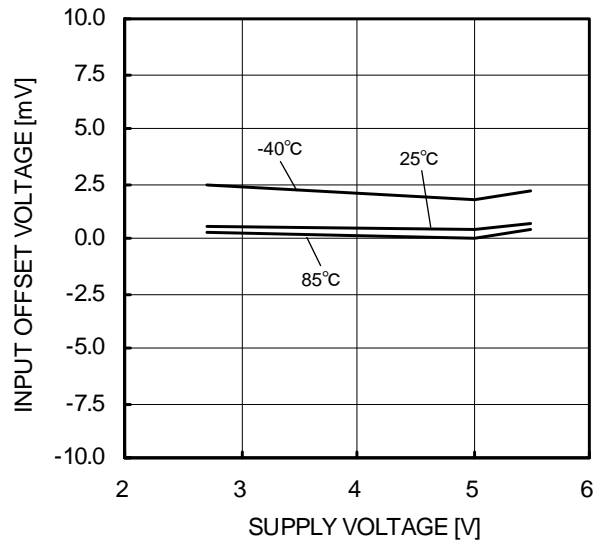

Figure 13.
Input Offset Voltage – Supply Voltage
(Vicm= VDD, OUT= 0.1V)

(*)The data above is measurement value of typical sample, it is not guaranteed.

OLMR321

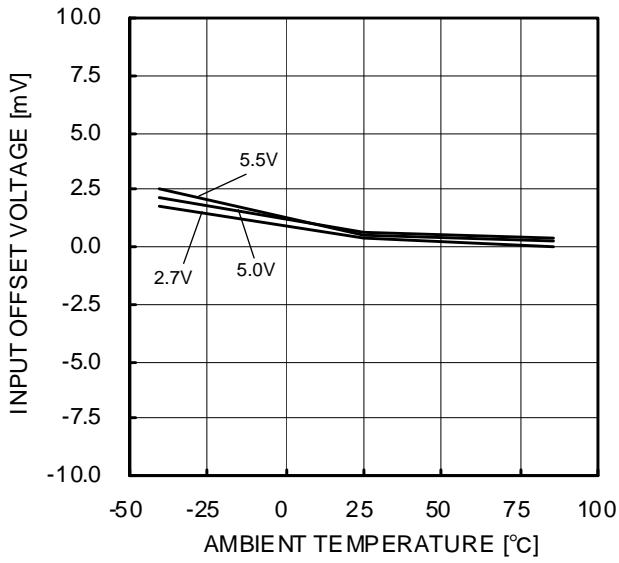

Figure 14.
Input Offset Voltage – Ambient Temperature
($V_{icm} = V_{DD}$, $OUT = 0.1V$)

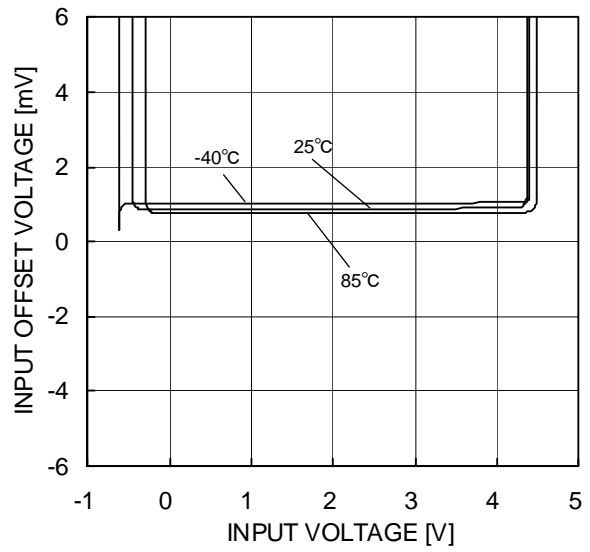

Figure 15.
Input Offset Voltage – Input Voltage
($V_{DD} = 5V$)

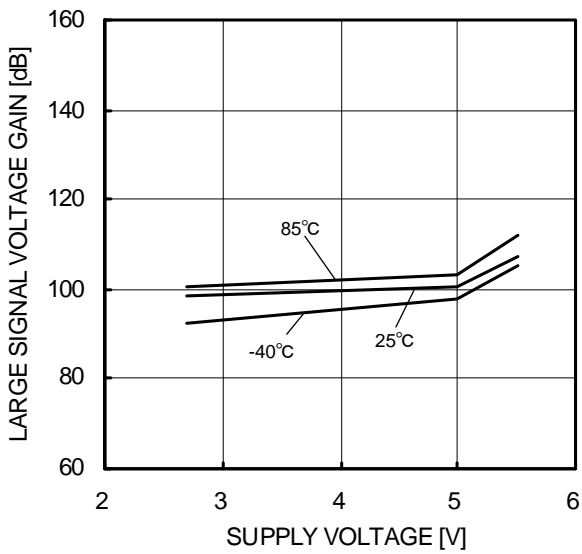

Figure 16.
Large Signal Voltage Gain – Supply Voltage

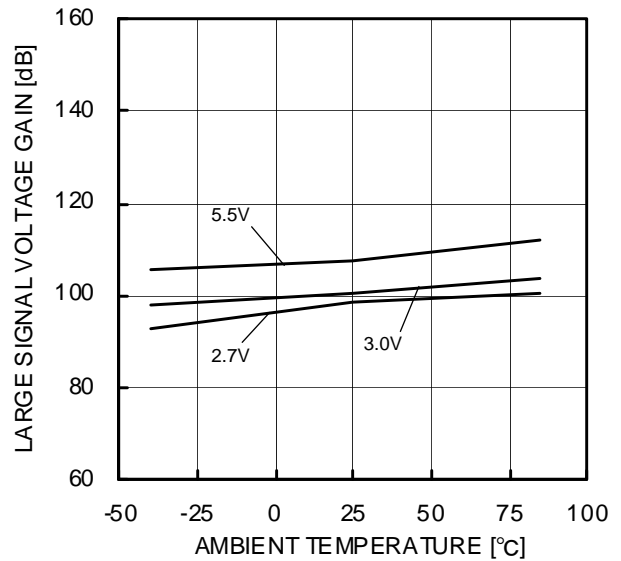

Figure 17.
Large Signal Voltage Gain – Ambient Temperature

(*)The data above is measurement value of typical sample, it is not guaranteed.

OLMR321

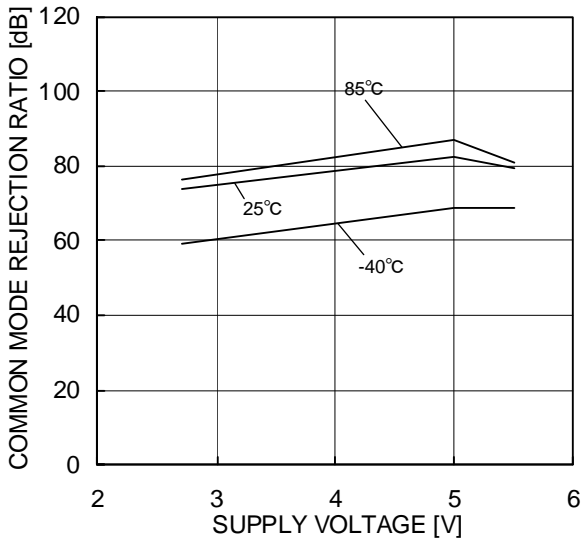

Figure 18.
Common Mode Rejection Ratio – Supply Voltage (VDD=5V)

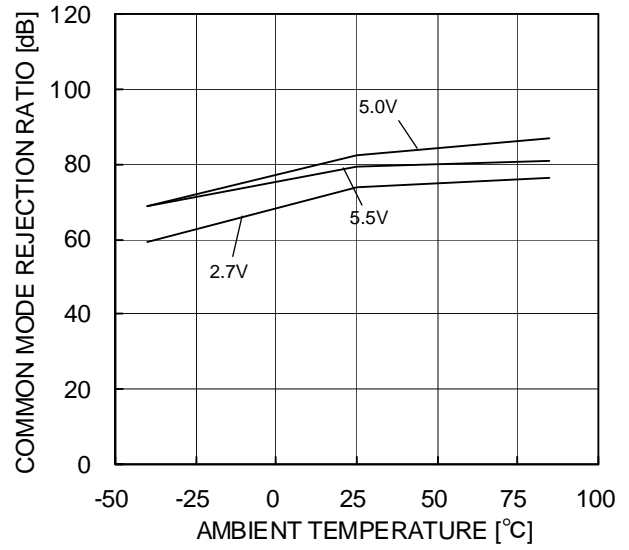

Figure 19.
Common Mode Rejection Ratio – Ambient Temperature (VDD=3V)

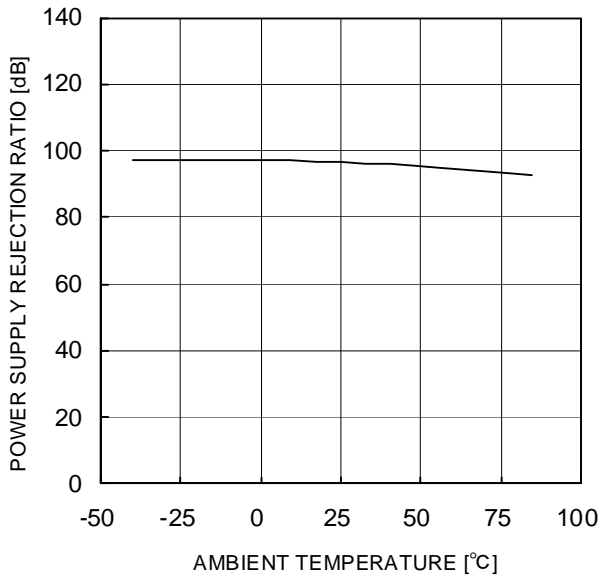

Figure 20.
Power Supply Rejection Ratio – Ambient Temperature

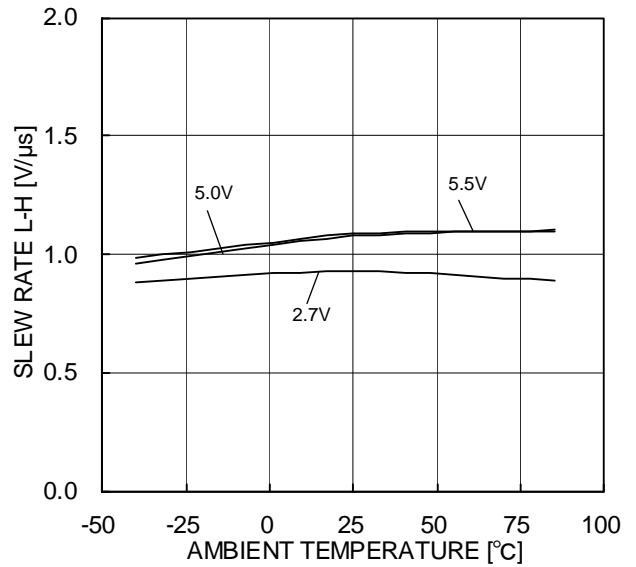

Figure 21.
Slew Rate L-H – Ambient Temperature

(*)The data above is measurement value of typical sample, it is not guaranteed.

OLMR321

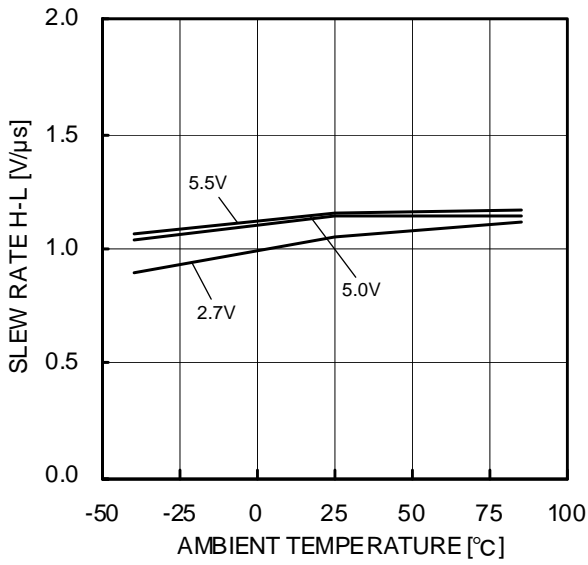

Figure 22. Slew Rate H-L – Ambient Temperature

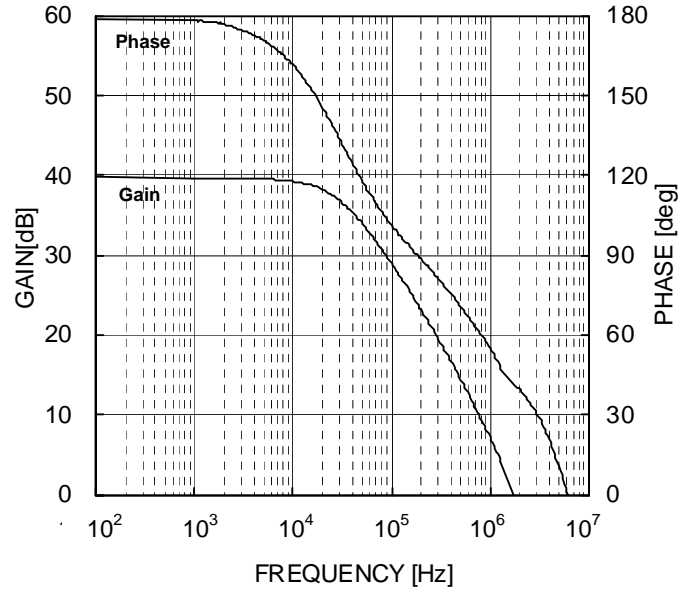

Figure 23. Voltage Gain • Phase – Frequency

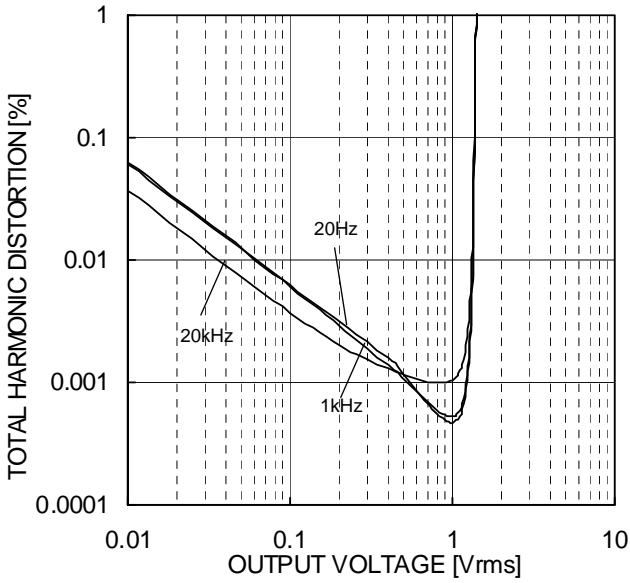

Figure 24. Total Harmonic Distortion—Output Voltage (VDD/VSS=+2.5V/-2.5V, Av=0dB, RL=2kΩ, DIN-AUDIO, Ta=25°C)

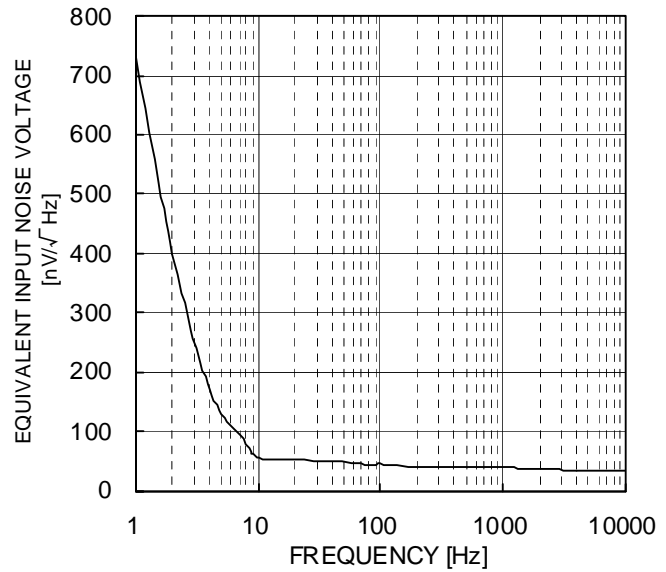

Figure 25. Input Referred Noise Voltage—Frequency (VDD/VSS=+2.5V/-2.5V, Av=0dB, Ta=25°C)

(*)The data above is measurement value of typical sample, it is not guaranteed.

OLMR358

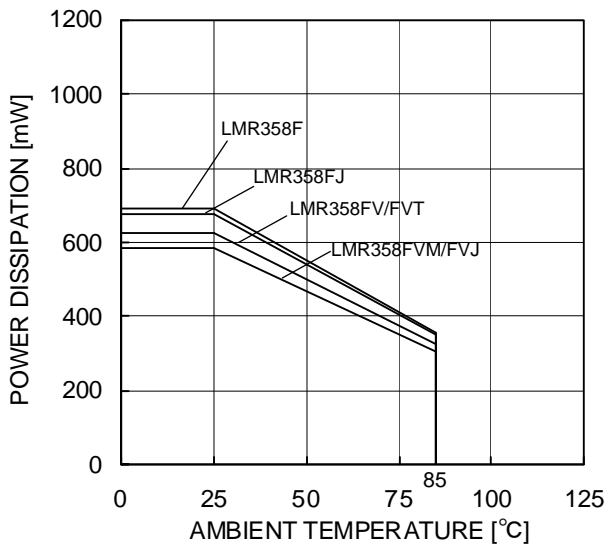

Figure 26.
Derating curve

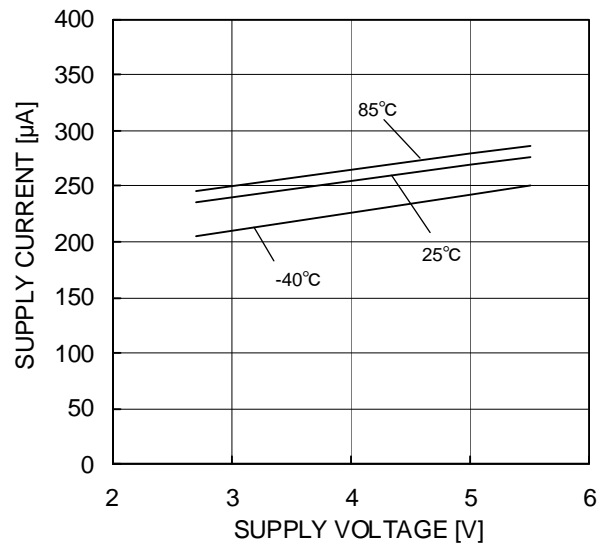

Figure 27.
Supply Current – Supply Voltage

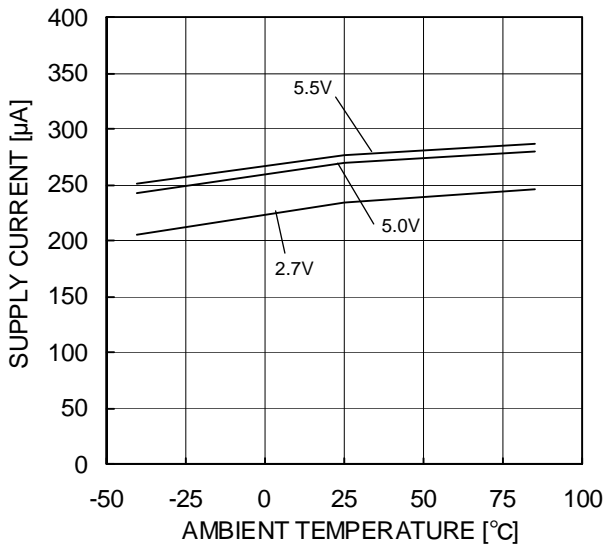

Figure 28.
Supply Current – Ambient Temperature

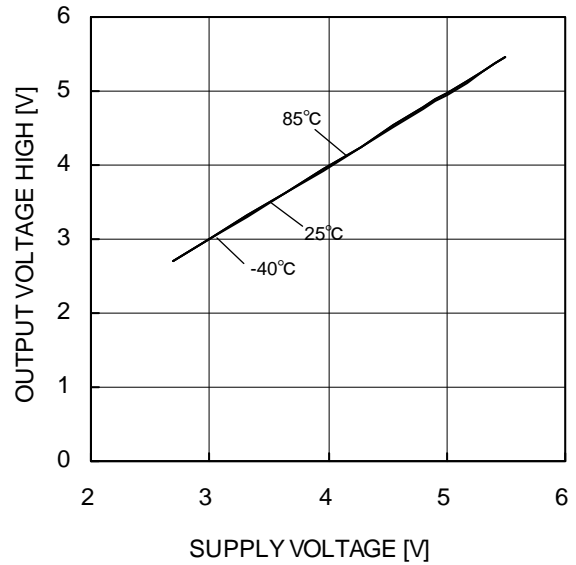

Figure 29.
Maximum Output Voltage(High)
– Supply Voltage
(RL=2kΩ)

(*)The data above is measurement value of typical sample, it is not guaranteed.

OLMR358

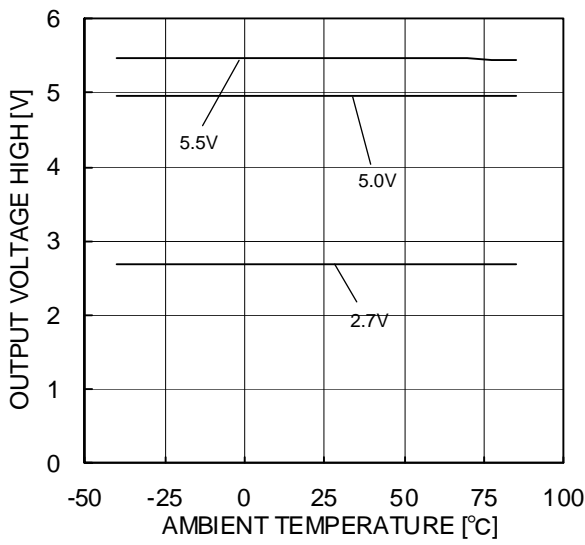

Figure 30.
Maximum Output Voltage(High)
– Ambient Temperature
(RL=2kΩ)

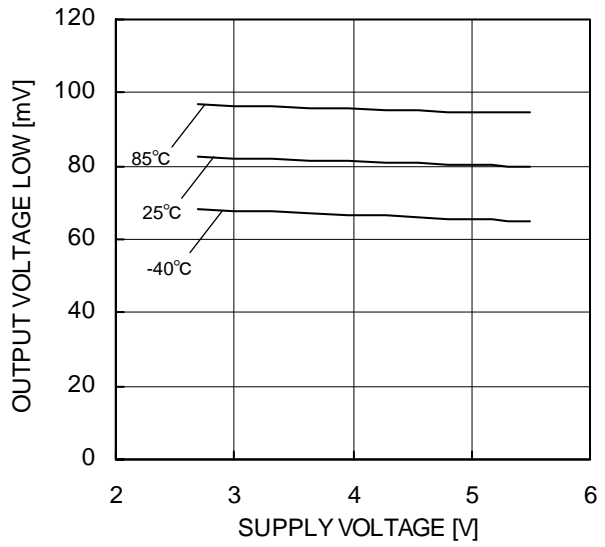

Figure 31.
Maximum Output Voltage(Low)
– Supply Voltage
(RL=2kΩ)

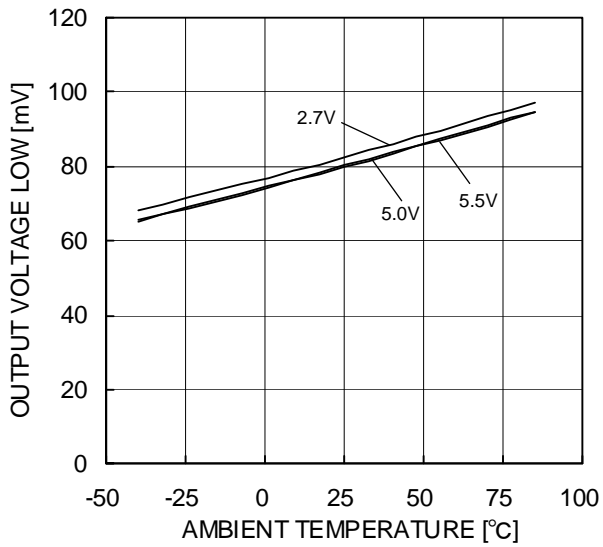

Figure 32.
Maximum Output Voltage(Low)
– Ambient Temperature
(RL=2kΩ)

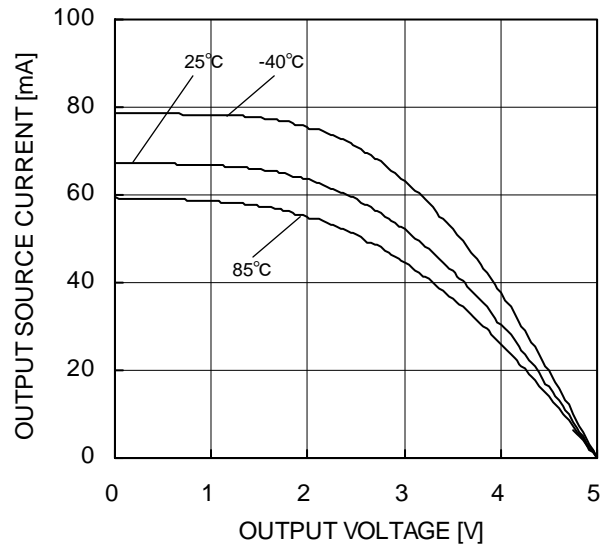

Figure 33.
Output Source Current – Output Voltage
(VDD=5V)

(*)The data above is measurement value of typical sample, it is not guaranteed.

OLMR358

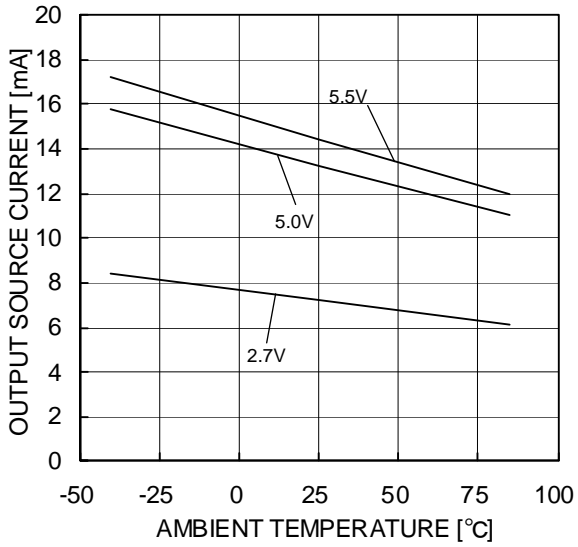

Figure 34.
Output Source Current – Ambient Temperature
(OUT=VDD-0.4V)

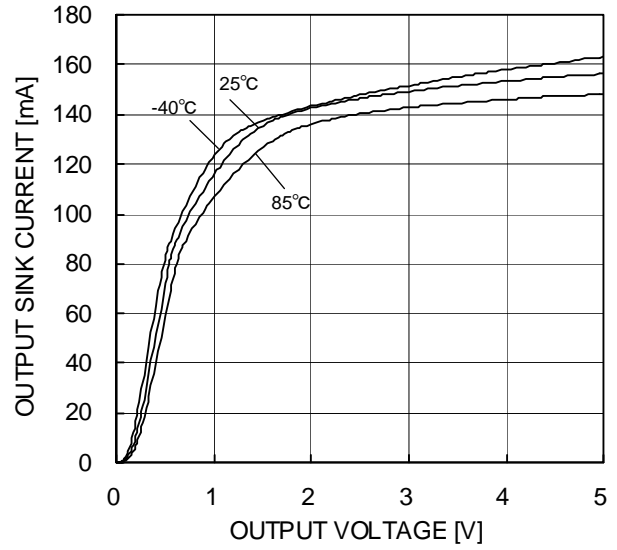

Figure 35.
Output Sink Current – Output Voltage
(VDD=5V)

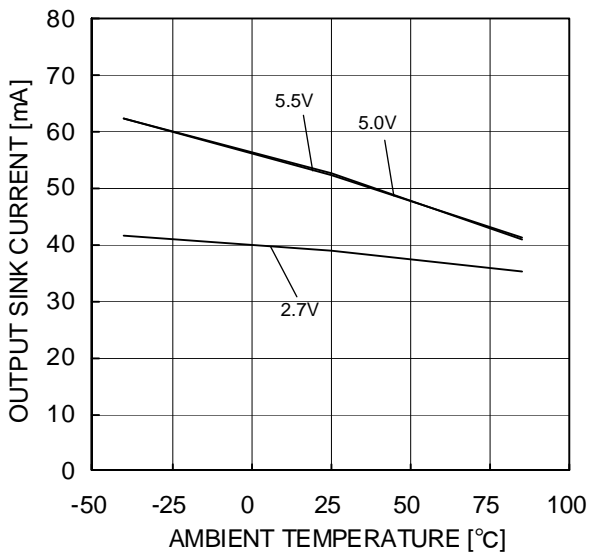

Figure 36.
Output Sink Current – Ambient Temperature
(OUT=VSS+0.4V)

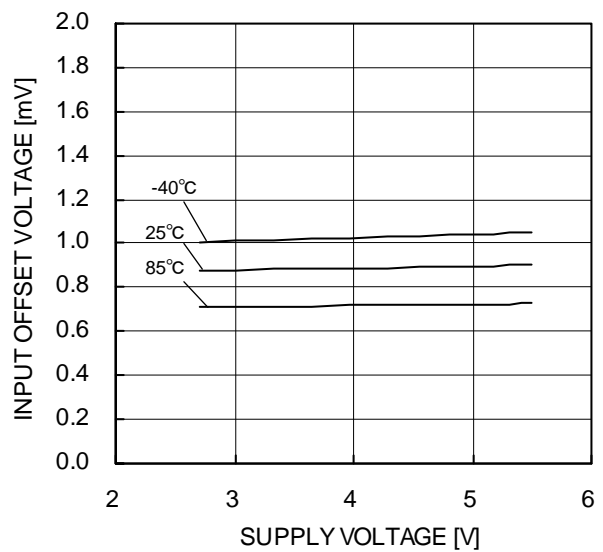

Figure 37.
Input Offset Voltage – Supply Voltage
(Vicm= VDD, OUT= 0.1V)

(*)The data above is measurement value of typical sample, it is not guaranteed.

OLMR358

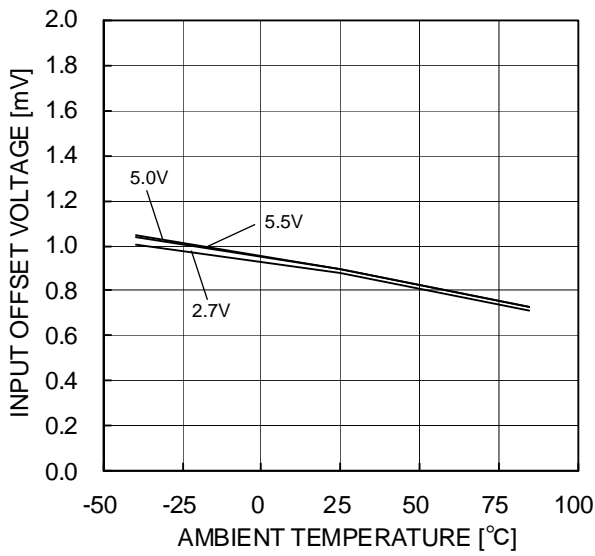

Figure 38.
Input Offset Voltage – Ambient Temperature
($V_{icm} = V_{DD}$, $OUT = 0.1V$)

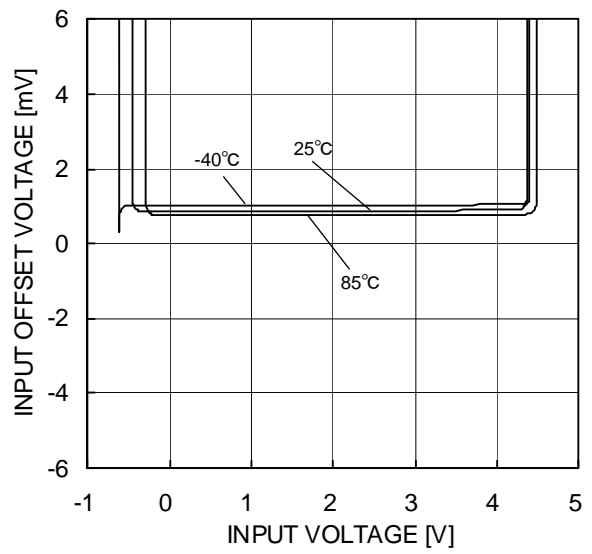

Figure 39.
Input Offset Voltage – Input Voltage
($V_{DD} = 5V$)

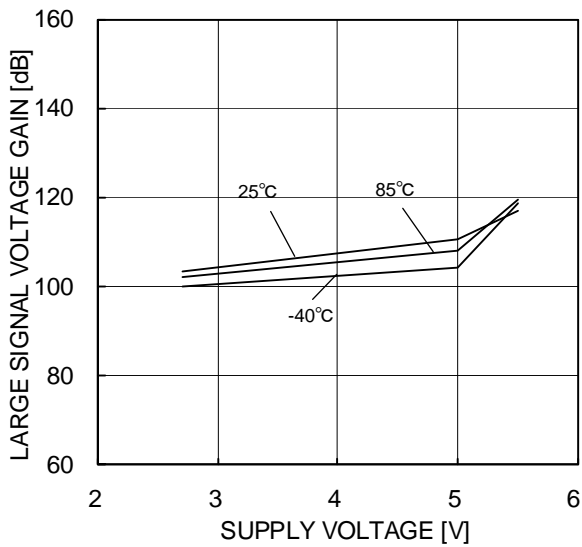

Figure 40.
Large Signal Voltage Gain – Supply Voltage

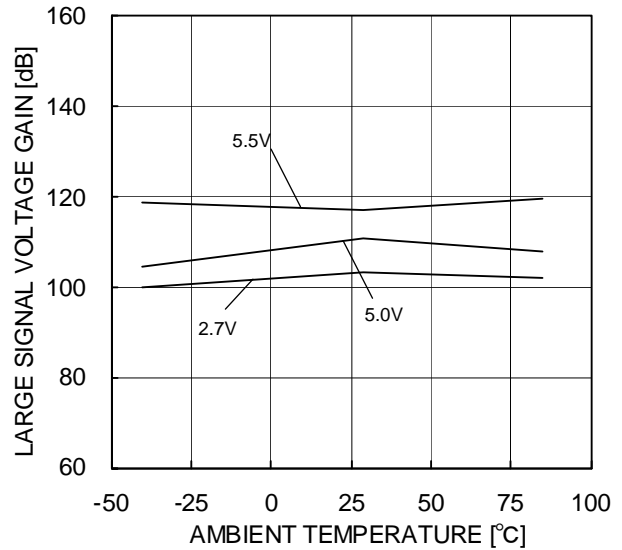

Figure 41.
Large Signal Voltage Gain – Ambient Temperature

(*)The data above is measurement value of typical sample, it is not guaranteed.

OLMR358

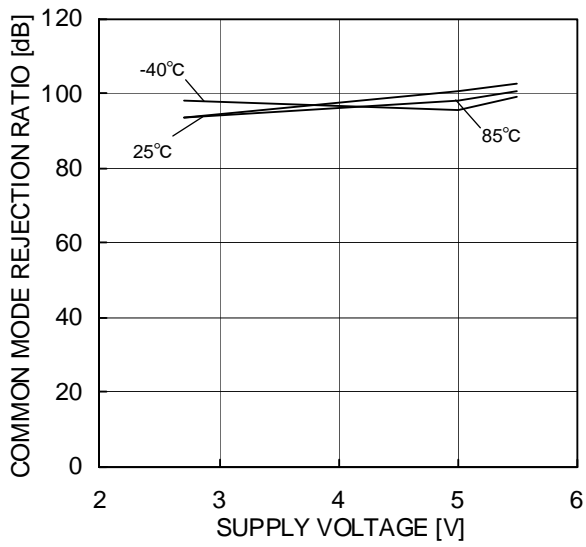

Figure 42.
Common Mode Rejection Ratio – Supply Voltage
(VDD=5V)

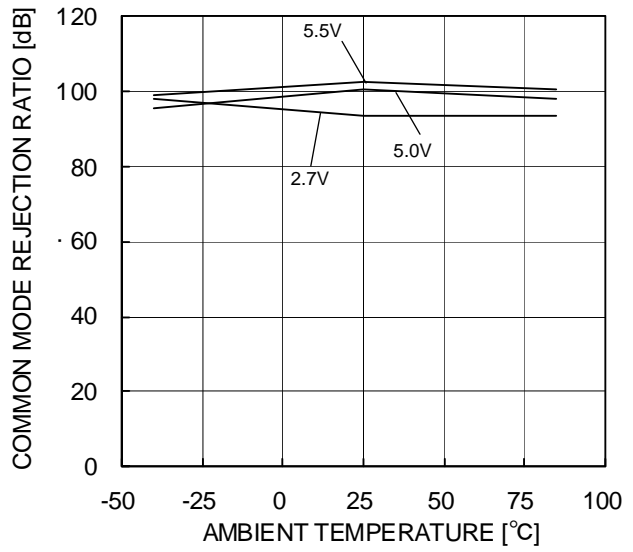

Figure 43.
Common Mode Rejection Ratio – Ambient Temperature
(VDD=3V)

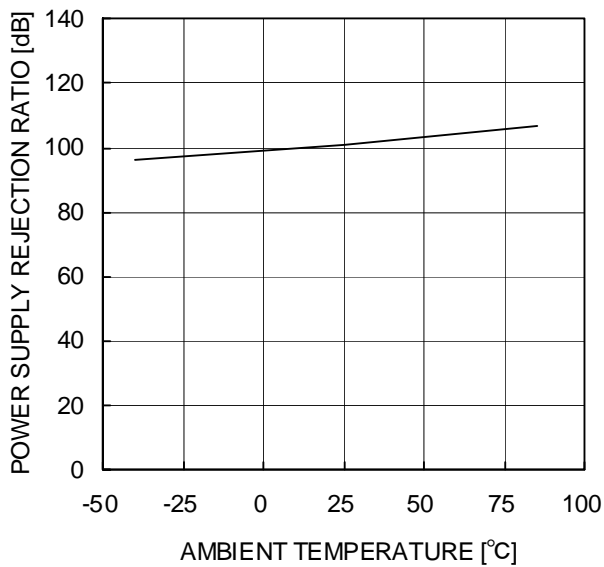

Figure 44.
Power Supply Rejection Ratio – Ambient Temperature

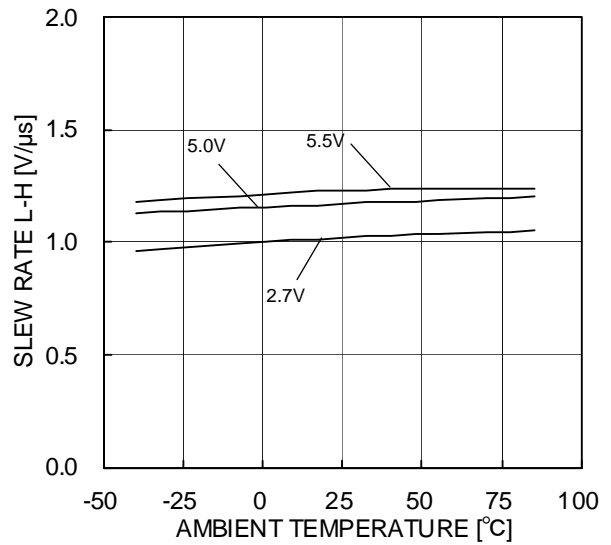

Figure 45.
Slew Rate L-H – Ambient Temperature

(*)The data above is measurement value of typical sample, it is not guaranteed.

OLMR358

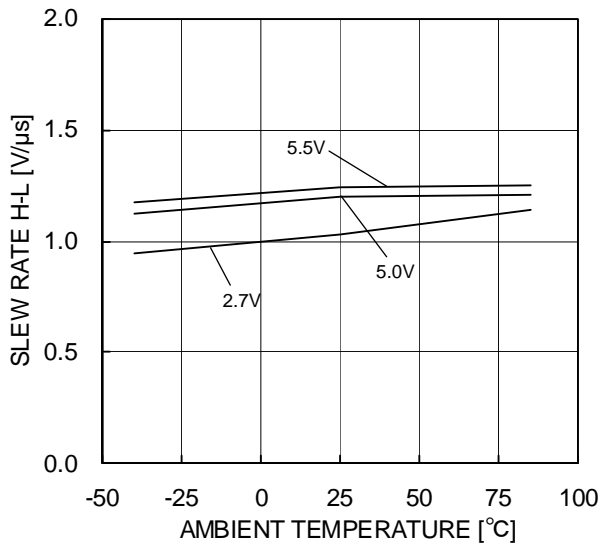

Figure 46.
Slew Rate H-L – Ambient Temperature

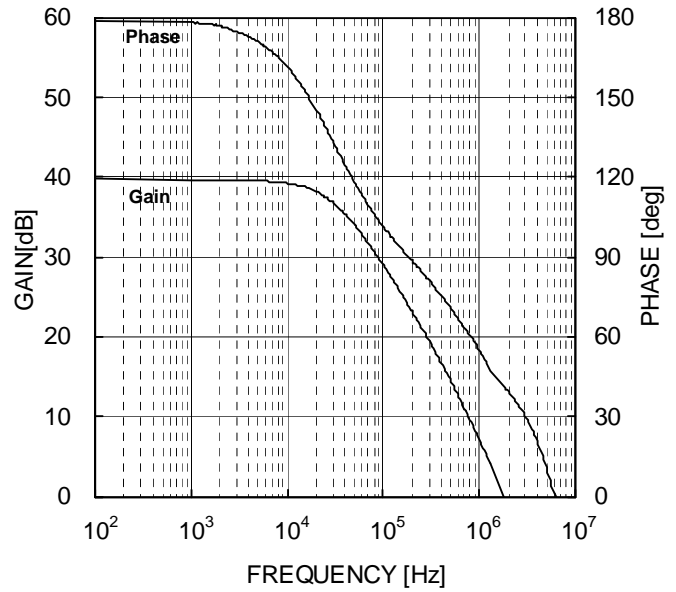

Figure 47.
Voltage Gain • Phase – Frequency

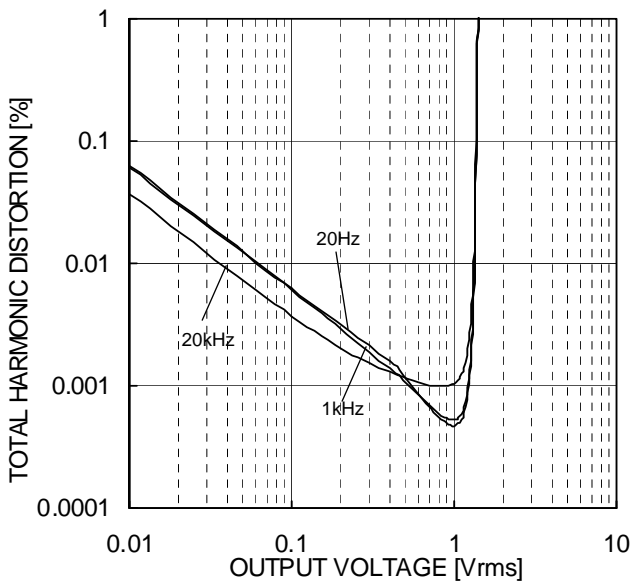

Figure 48.
Total Harmonic Distortion – Output Voltage
(VDD/VSS=+2.5V/-2.5V, Av=0dB,
RL=2kΩ, DIN-AUDIO, Ta=25°C)

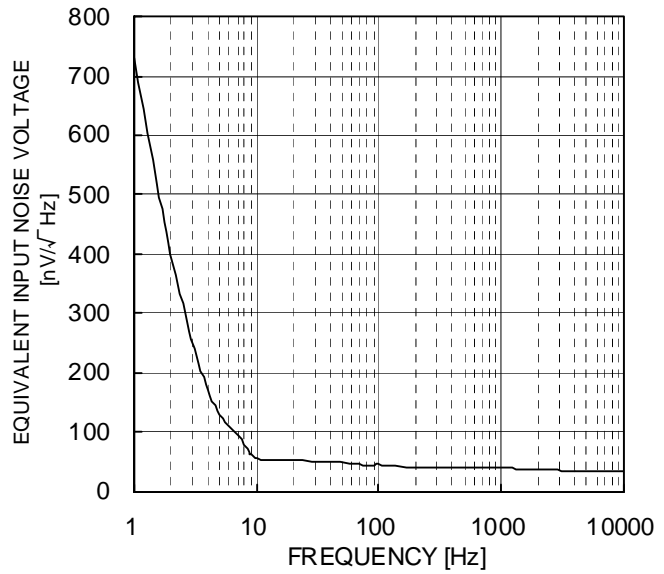

Figure 49.
Input Referred Noise Voltage – Frequency
(VDD/VSS=+2.5V/-2.5V, Av=0dB, Ta=25°C)

(*)The data above is measurement value of typical sample, it is not guaranteed.

OLMR324

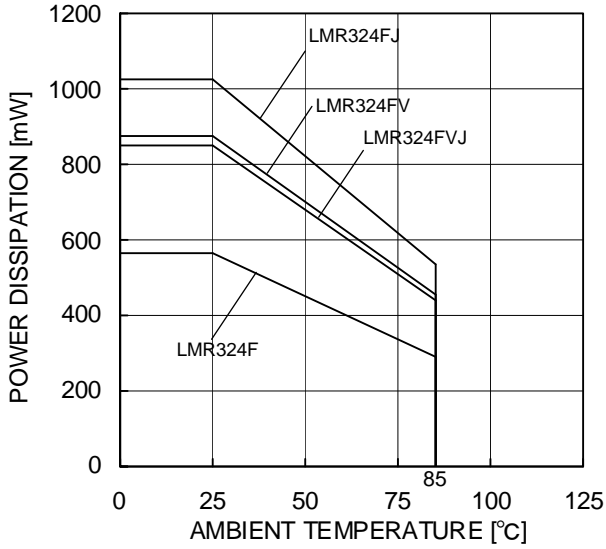

Figure 50.
Derating curve

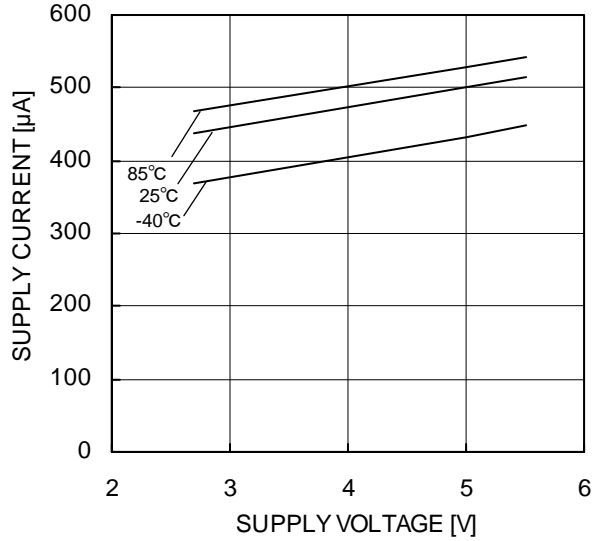

Figure 51.
Supply Current – Supply Voltage

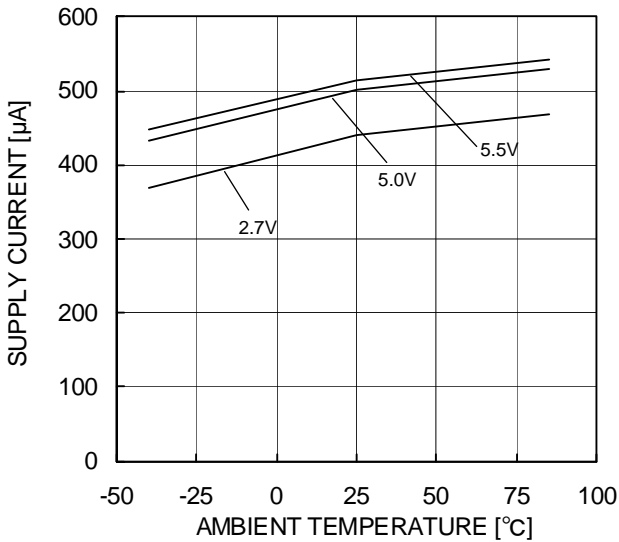

Figure 52.
Supply Current – Ambient Temperature

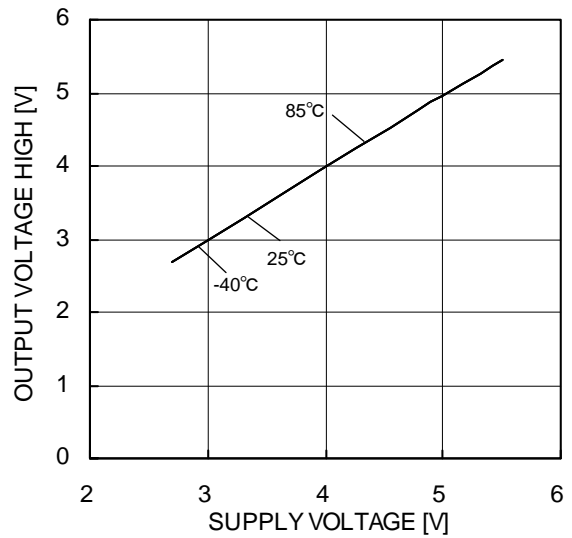

Figure 53.
Maximum Output Voltage(High)
– Supply Voltage
(RL=2 kΩ)

(*)The data above is measurement value of typical sample, it is not guaranteed.

OLMR324

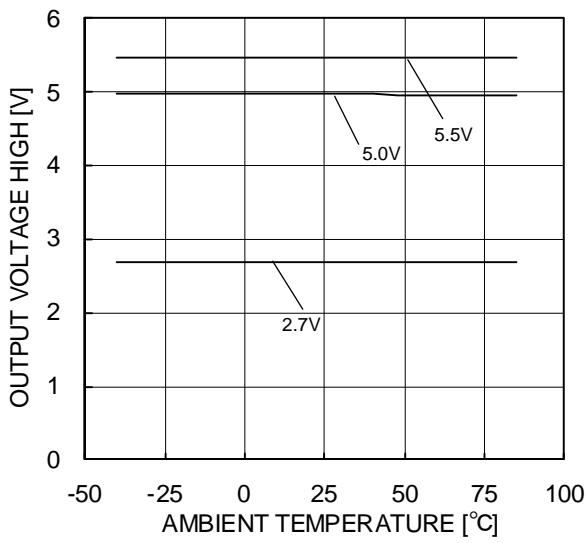

Figure 54.
Maximum Output Voltage(High)
– Ambient Temperature
(RL=2kΩ)

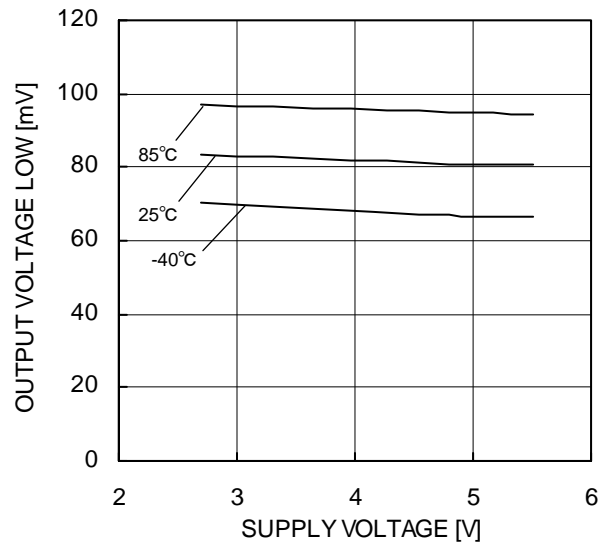

Figure 55.
Maximum Output Voltage(Low)
– Supply Voltage
(RL=2kΩ)

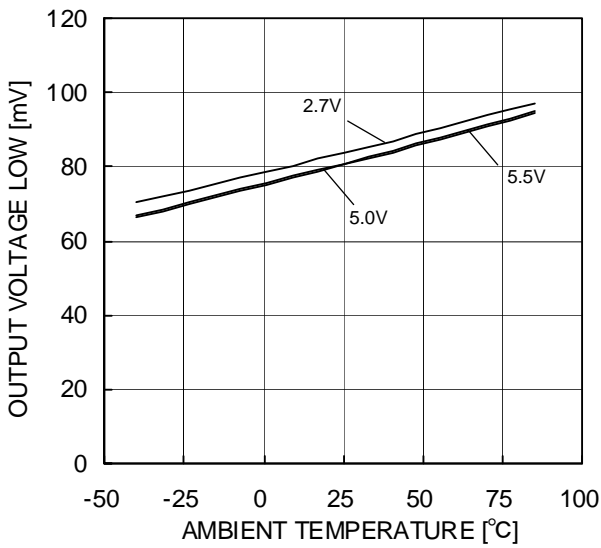

Figure 56.
Maximum Output Voltage(Low)
– Ambient Temperature
(RL=2kΩ)

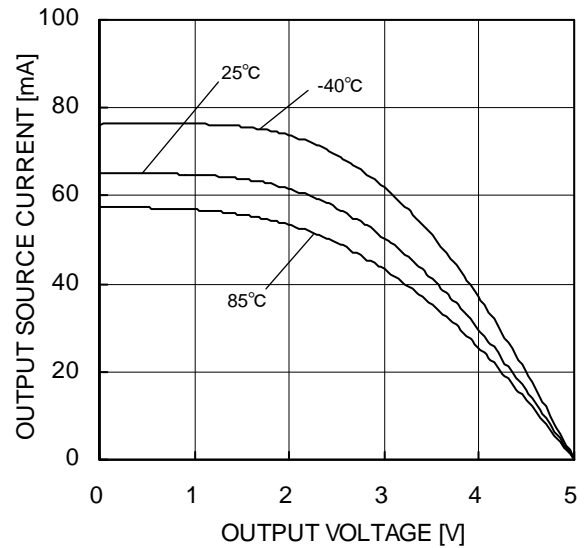

Figure 57.
Output Source Current – Output Voltage
(VDD=5V)

(*)The data above is measurement value of typical sample, it is not guaranteed.

OLMR324

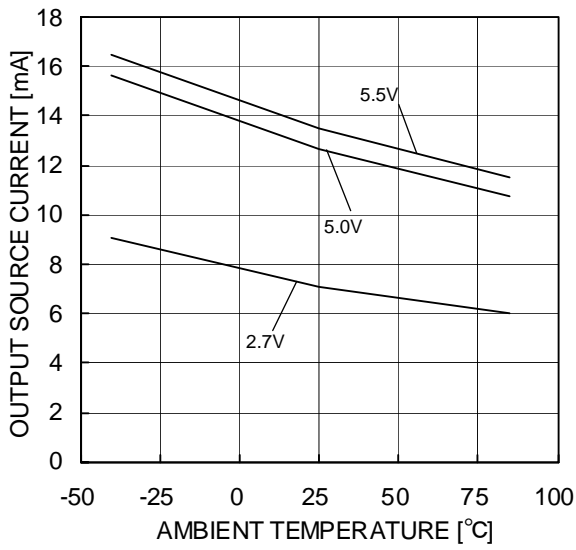

Figure 58.
Output Source Current – Ambient Temperature
(OUT=VDD-0.4V)

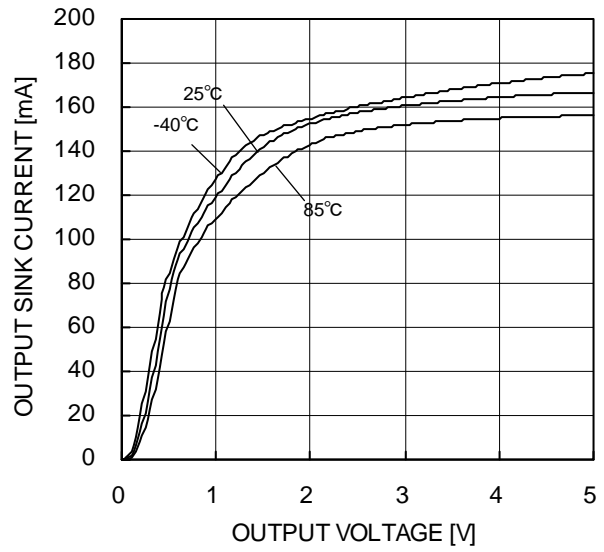

Figure 59.
Output Sink Current – Output Voltage
(VDD=5V)

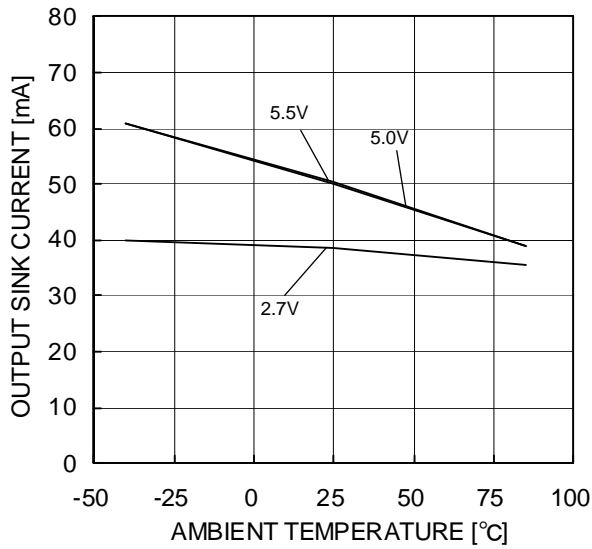

Figure 60.
Output Sink Current – Ambient Temperature
(OUT=VSS+0.4V)

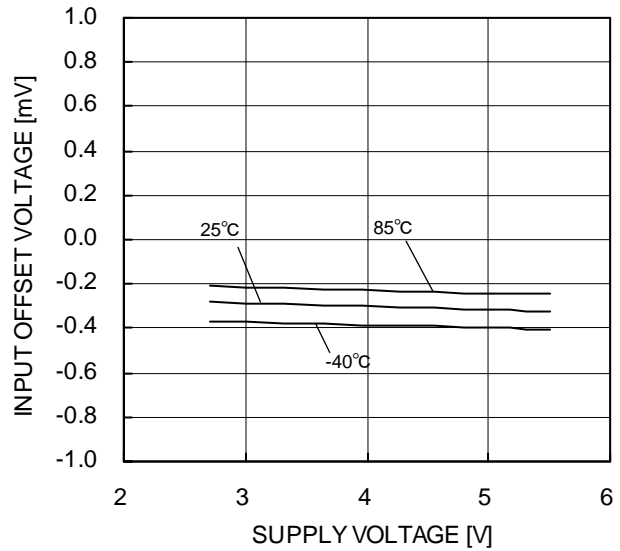

Figure 61.
Input Offset Voltage – Supply Voltage
(Vicm= VDD, OUT= 0.1V)

(*)The data above is measurement value of typical sample, it is not guaranteed.

OLMR324

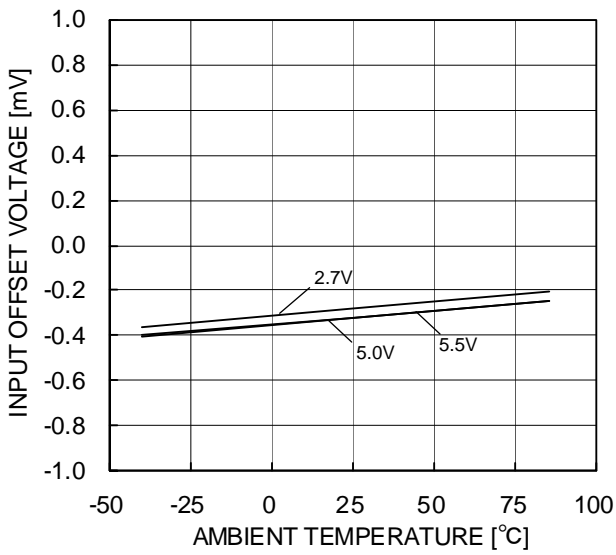

Figure 62.
Input Offset Voltage – Ambient Temperature
(Vicm= VDD, OUT= 0.1V)

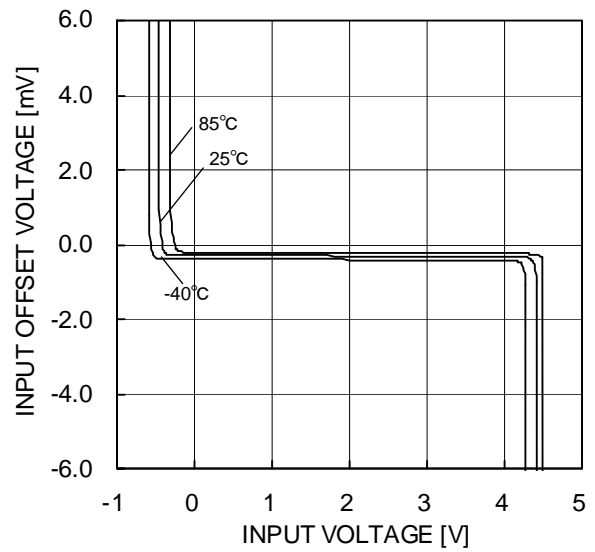

Figure 63.
Input Offset Voltage – Input Voltage
(VDD=5V)

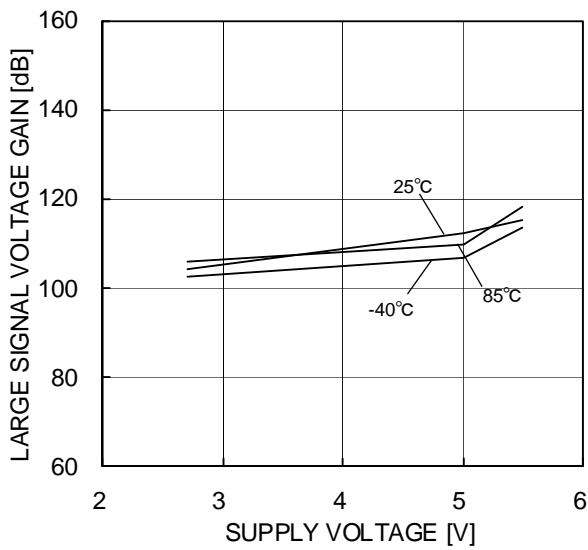

Figure 64.
Large Signal Voltage Gain – Supply Voltage

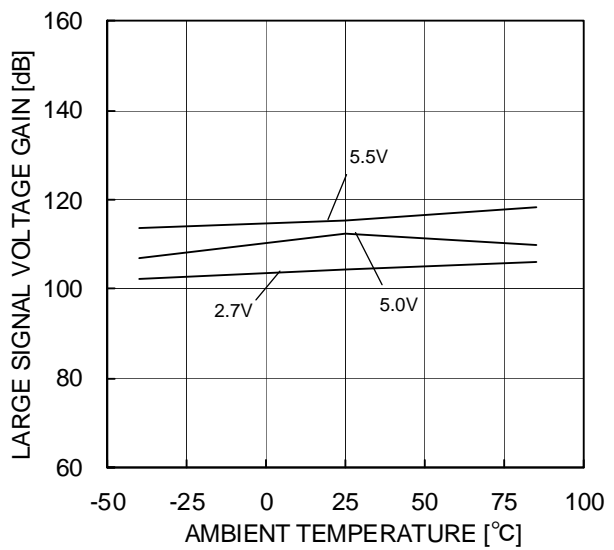

Figure 65.
Large Signal Voltage Gain – Ambient Temperature

(*)The data above is measurement value of typical sample, it is not guaranteed.

OLMR324

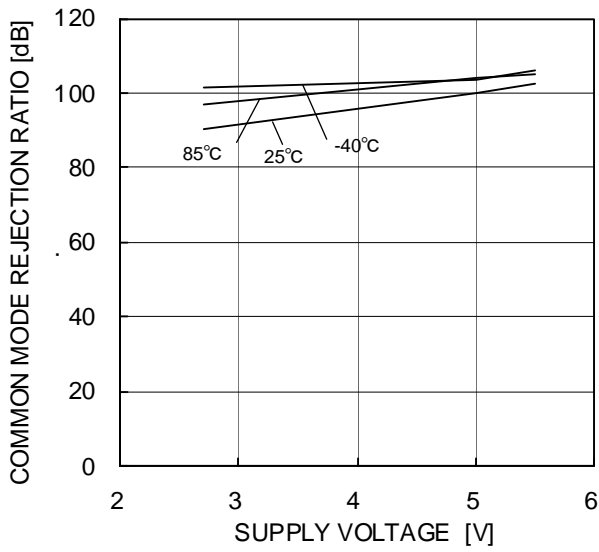

Figure 66.
Common Mode Rejection Ratio – Supply Voltage (VDD=5V)

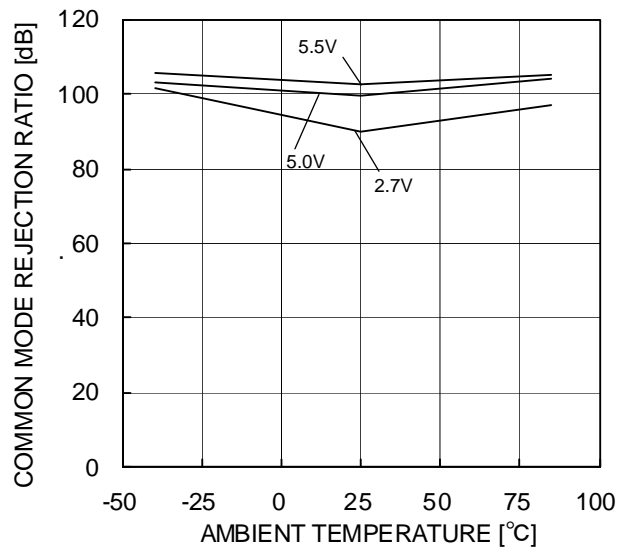

Figure 67.
Common Mode Rejection Ratio – Ambient Temperature (VDD=3V)

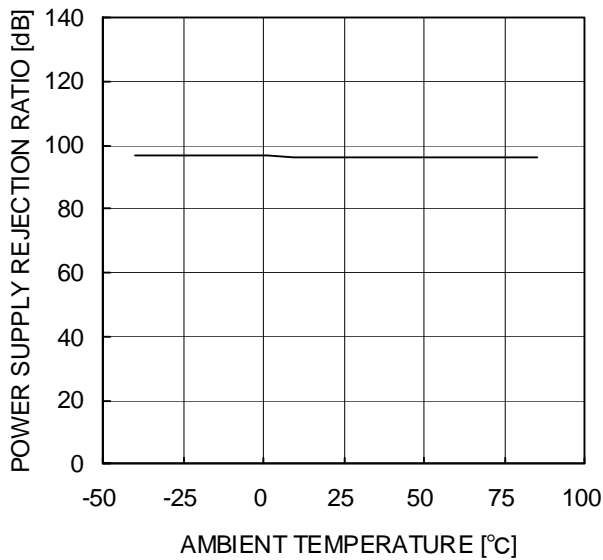

Figure 68.
Power Supply Rejection Ratio – Ambient Temperature

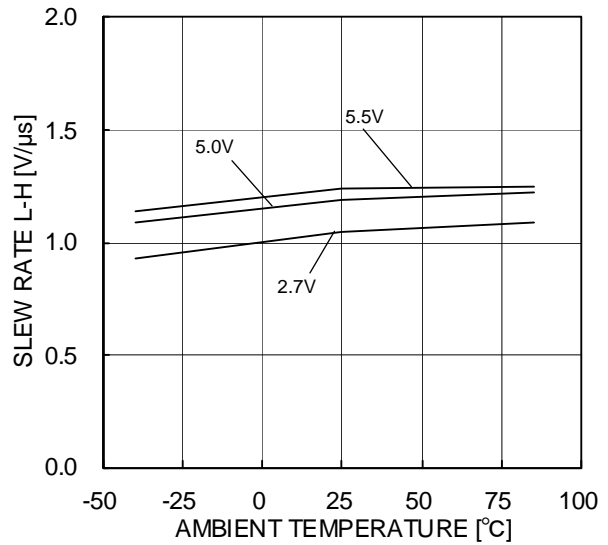

Figure 69.
Slew Rate L-H – Ambient Temperature

(*)The data above is measurement value of typical sample, it is not guaranteed.

OLMR324

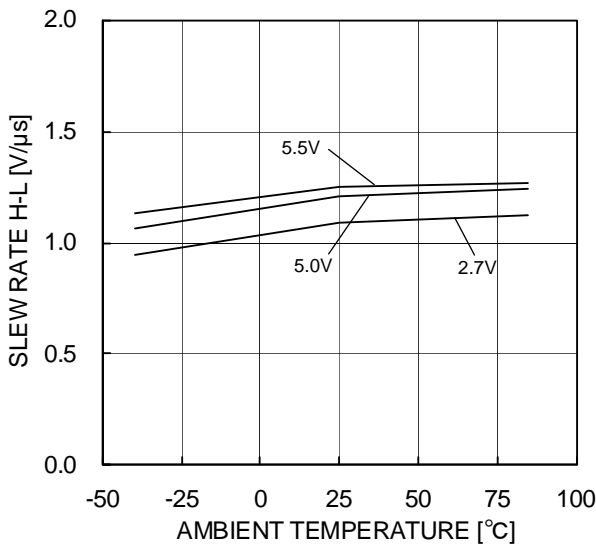

Figure 70.
Slew Rate H-L – Ambient Temperature

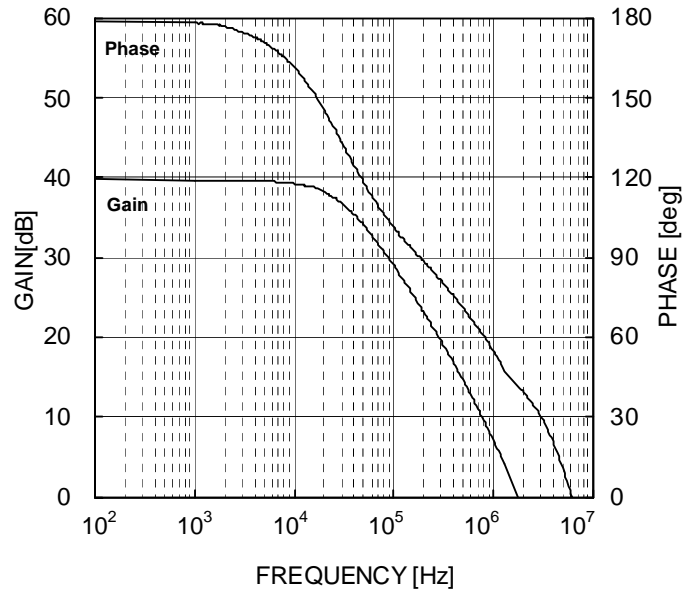

Figure 71.
Voltage Gain · Phase – Frequency

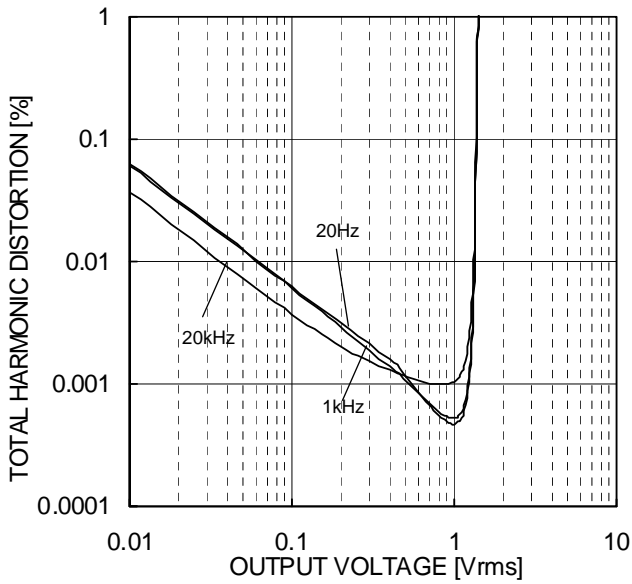

Figure 72.
Total Harmonic Distortion – Output Voltage
(VDD/VSS=+2.5V/-2.5V, Av=0dB, RL=2kΩ, DIN-AUDIO, Ta=25°C)

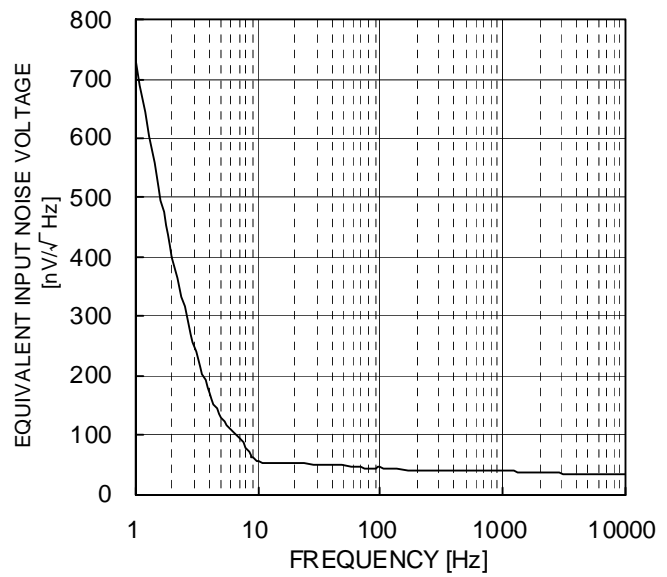

Figure 73.
Input Referred Noise Voltage – Frequency
(VDD/VSS=+2.5V/-2.5V, Av=0dB, Ta=25°C)

(*)The data above is measurement value of typical sample, it is not guaranteed.

● Application Information
 NULL method condition for Test Circuit 1

VDD, VSS, EK, Vicm Unit:V

Parameter	VF	S1	S2	S3	VDD	VSS	EK	Vicm	Calculation
Input Offset Voltage	VF1	ON	ON	OFF	5	0	-2.5	2.1	1
Large Signal Voltage Gain	VF2	ON	ON	ON	5	0	-1.5	2.1	2
	VF3						-3.5		
Common-mode Rejection Ratio (Input Common-mode Voltage Range)	VF4	ON	ON	OFF	5	0	-1.5	0	3
	VF5						-1.8	1.8	
Power Supply Rejection Ratio	VF6	ON	ON	OFF	3	0	-2.9	4	4
	VF7				5				

— Calculation —

1. Input Offset Voltage (Vio)

$$V_{io} = \frac{|VF1|}{1+R_F/R_S} [V]$$

2. Large Signal Voltage Gain(Av)

$$A_v = 20\text{Log} \frac{2 \times (1+R_F/R_S)}{|VF2-VF3|} [dB]$$

3. Common-mode Rejection Ratio (CMRR)

$$\text{CMRR} = 20\text{Log} \frac{1.8 \times (1+R_F/R_S)}{|VF4 - VF5|} [dB]$$

4. Power Supply Rejection Ratio (PSRR)

$$\text{PSRR} = 20\text{Log} \frac{3.8 \times (1+ R_F/R_S)}{|VF6 - VF7|} [dB]$$

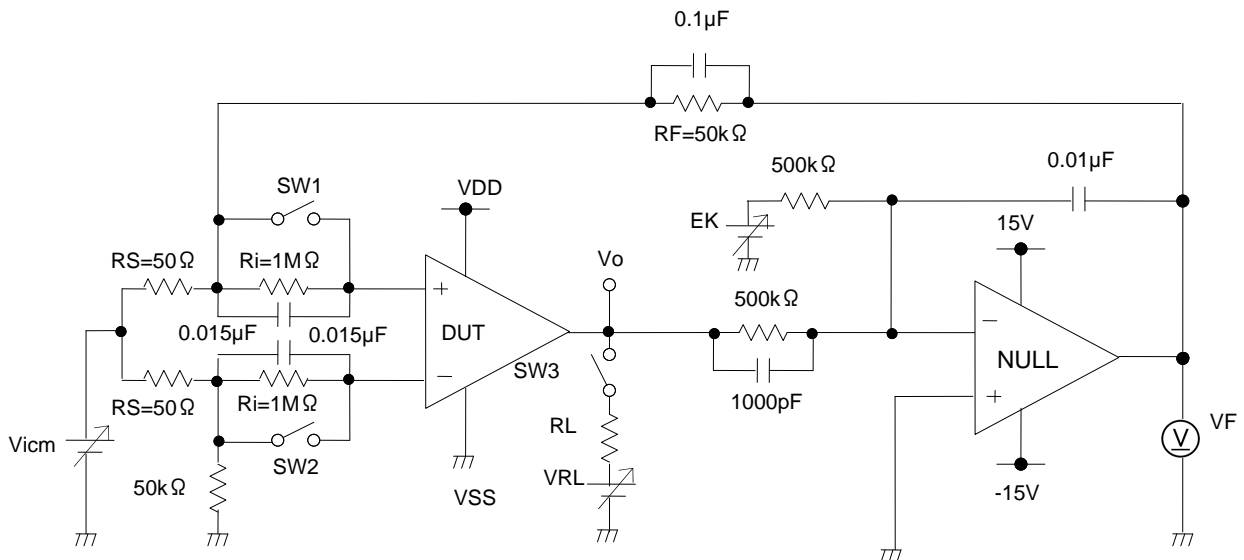

Figure 74. Test circuit 1 (one channel only)

Switch Condition for Test Circuit 2

SW No.	SW1	SW2	SW3	SW4	SW5	SW6	SW7	SW8	SW9	SW10	SW11	SW12	SW13	SW14
Supply Current	OFF	OFF	OFF	ON	OFF	ON	OFF	OFF	OFF	OFF	OFF	OFF	OFF	OFF
Maximum Output Voltage(High)	OFF	OFF	ON	OFF	OFF	ON	OFF	OFF	ON	OFF	OFF	OFF	ON	OFF
Maximum Output Voltage(Low)	OFF	OFF	ON	OFF	OFF	ON	OFF	OFF	OFF	OFF	OFF	OFF	ON	OFF
Output Source Current	OFF	OFF	ON	OFF	OFF	ON	OFF	OFF	OFF	OFF	OFF	OFF	OFF	ON
Output Sink Current	OFF	OFF	ON	OFF	OFF	ON	OFF	OFF	OFF	OFF	OFF	OFF	OFF	ON
Slew Rate	OFF	OFF	OFF	ON	OFF	OFF	OFF	ON	ON	ON	OFF	OFF	OFF	OFF
Gain Bandwidth Product	OFF	ON	OFF	OFF	ON	ON	OFF	OFF	ON	ON	OFF	OFF	OFF	OFF
Equivalent Input Noise Voltage	ON	OFF	OFF	OFF	ON	ON	OFF	OFF	OFF	OFF	ON	OFF	OFF	OFF

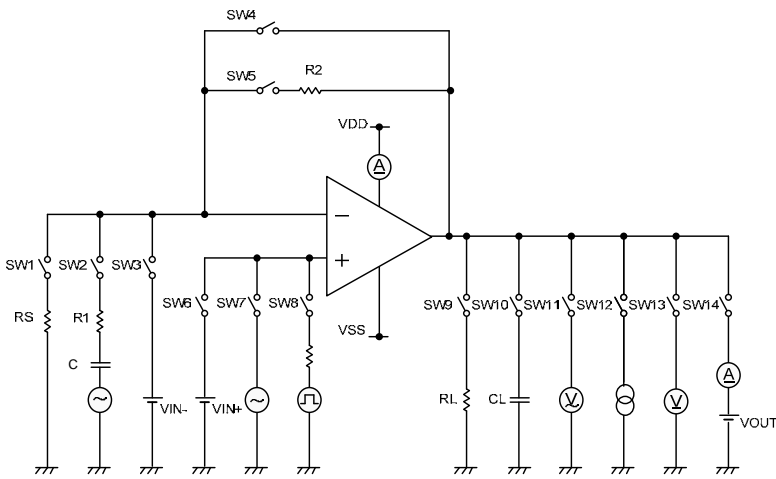

Figure 75. Test Circuit 2 (each Op-Amp)

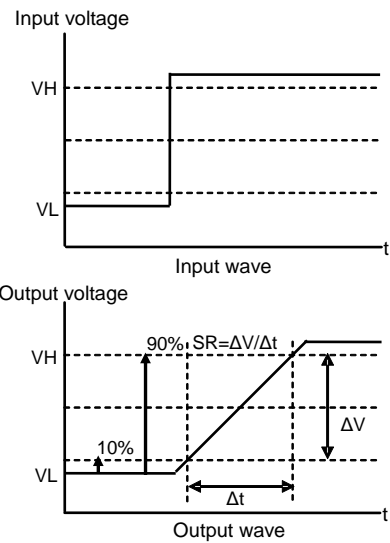

Figure 76. Slew Rate Input Waveform

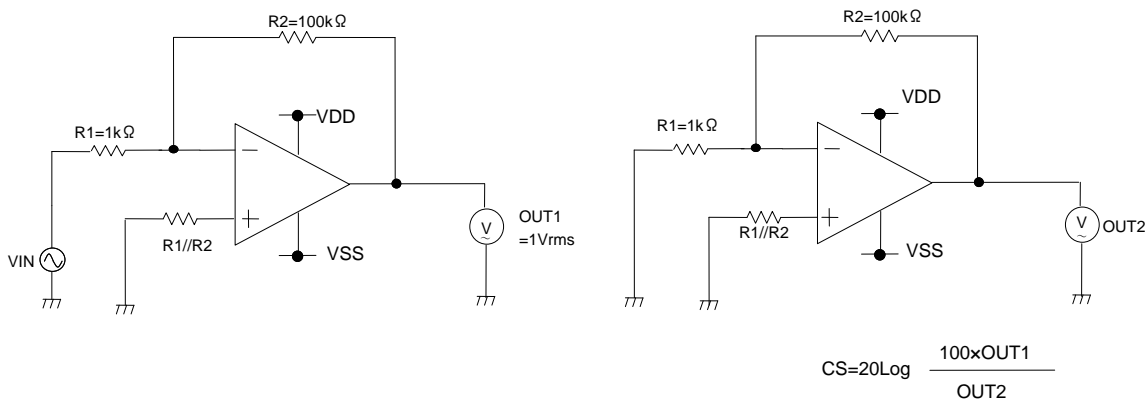

Figure 77. Test circuit 3(Channel Separation)

Application example

○Voltage Follower

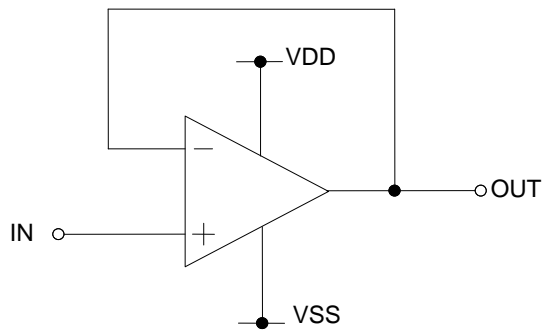

Figure 78. Voltage follower

Voltage gain is 0 dB.

This circuit controls output voltage (OUT) equal input voltage (IN), and keeps OUT with stable because of high input impedance and low output impedance.

OUT is shown next expression.

$$OUT=IN$$

○Inverting amplifier

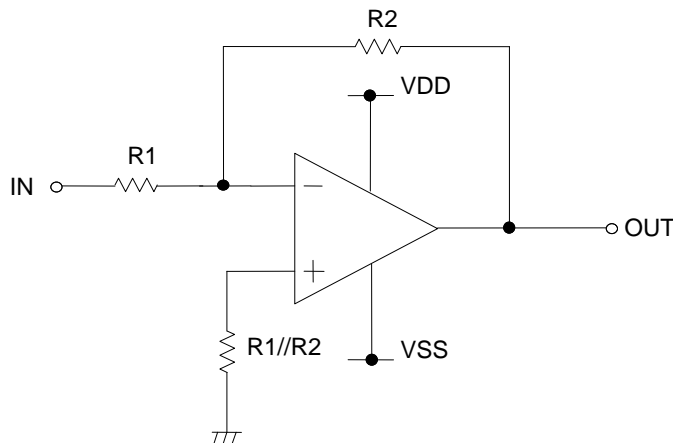

Figure 79. Inverting amplifier

For inverting amplifier, IN is amplified by voltage gain decided R1 and R2, and phase reversed voltage is output.

OUT is shown next expression.

$$OUT=-\left(\frac{R2}{R1}\right) \cdot IN$$

Input impedance is R1.

○Non-inverting amplifier

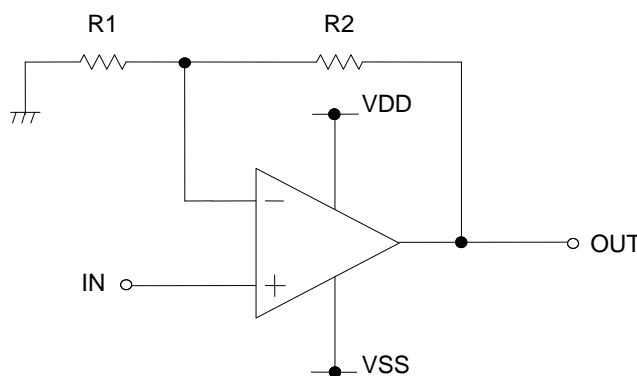

Figure 80. Non-inverting amplifier

For non-inverting amplifier, IN is amplified by voltage gain decided R1 and R2, and phase is same with Vin.

OUT is shown next expression.

$$OUT=\left(1+\frac{R2}{R1}\right) \cdot IN$$

This circuit performs high input impedance because Input impedance is operational amplifier's input Impedance.

○Adder circuit

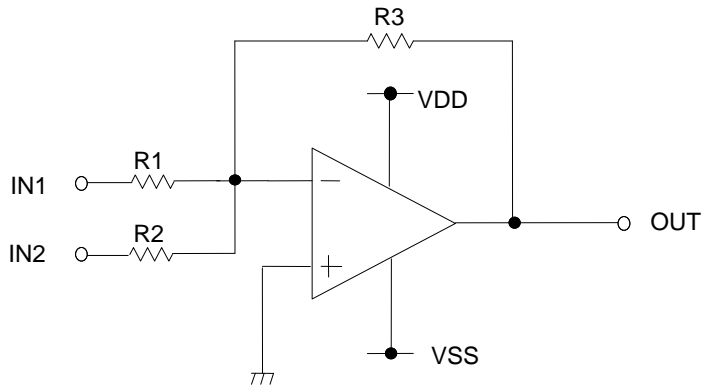

Figure 81. Adder circuit

Adder circuit output the voltage that added up Input voltage. A phase of the output voltage turns over, because non-inverting circuit is used.

OUT is shown next formula.

$$\text{OUT} = -R3(\text{IN1}/R1 + \text{IN2}/R2)$$

When three input voltage is as above, it connects with input through resistance like R1 and R2.

○Differential amplifier

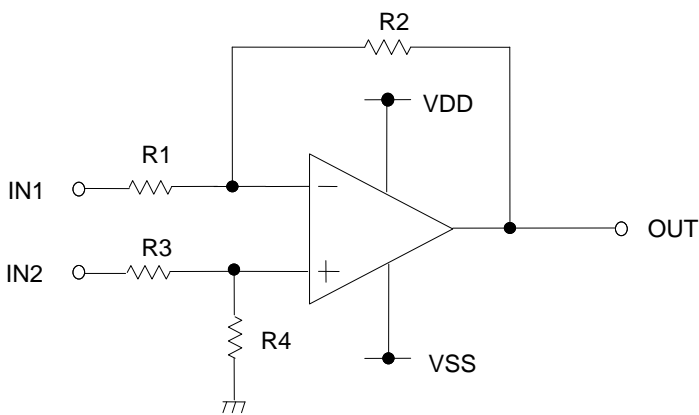

Figure 82. Differential amplifier

Differential amplifier output the voltage that amplified a difference of input voltage.

In the case of $R1=R3=R_a$, $R2=R4=R_b$

OUT is shown next formula.

$$\text{OUT} = -R_b/R_a(\text{IN1} - \text{IN2})$$

●Power Dissipation

Power dissipation (total loss) indicates the power that can be consumed by IC at Ta=25°C(normal temperature). IC is heated when it consumed power, and the temperature of IC chip becomes higher than ambient temperature. The temperature that can be accepted by IC chip depends on circuit configuration, manufacturing process, and consumable power is limited. Power dissipation is determined by the temperature allowed in IC chip (maximum junction temperature) and thermal resistance of package (heat dissipation capability).The maximum junction temperature is typically equal to the maximum value in the storage package (heat dissipation capability).The maximum junction temperature is typically equal to the maximum value in the storage temperature range. Heat generated by consumed power of IC radiates from the mold resin or lead frame of the package. The parameter which indicates this heat dissipation capability (hardness of heat release) is called thermal resistance, represented by the symbol θ_{ja} °C/W. The temperature of IC inside the package can be estimated by this thermal resistance. Figure 83. (a) shows the model of thermal resistance of the package. Thermal resistance θ_{ja} , ambient temperature Ta, maximum junction temperature Tjmax, and power dissipation Pd can be calculated by the equation below:

$$\theta_{ja} = (T_{jmax} - T_a) / P_d \quad \text{°C/W} \quad \dots \dots \dots (I)$$

Derating curve in Figure 83. (b) indicates power that can be consumed by IC with reference to ambient temperature. Power that can be consumed by IC begins to attenuate at certain ambient temperature. This gradient is determined by thermal resistance θ_{ja} . Thermal resistance θ_{ja} depends on chip size, power consumption, package, ambient temperature, package condition, wind velocity, etc even when the same of package is used. Thermal reduction curve indicates a reference value measured at a specified condition. Figure 84 (c)-(e) show a derating curve for an example LMR321, LMR358, LMR324.

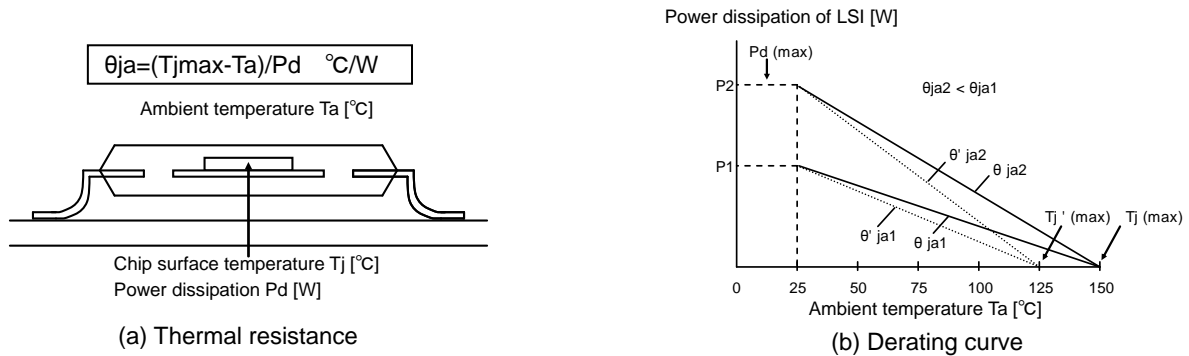
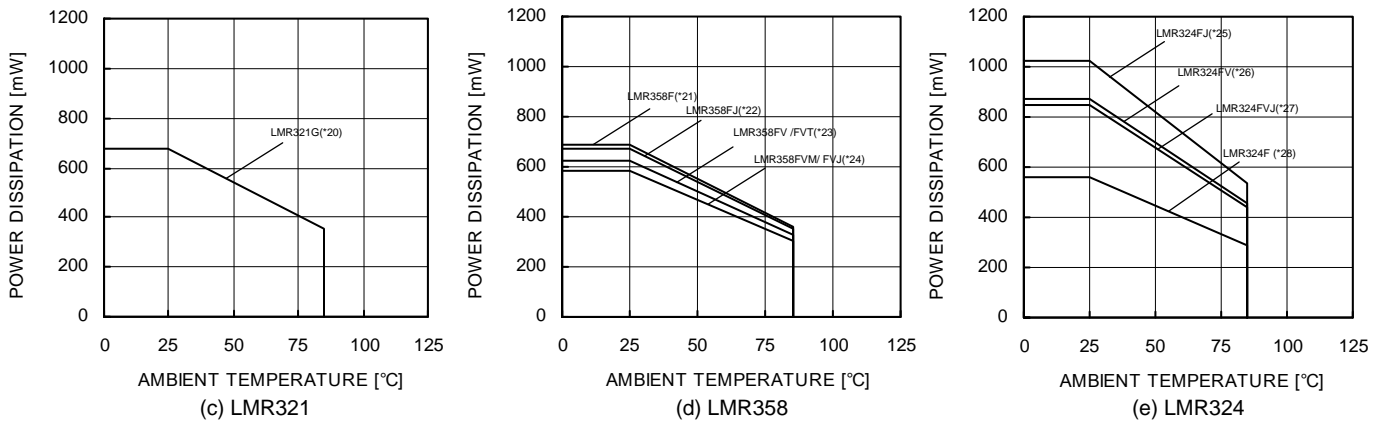

Figure 83. Thermal resistance and derating



(*20)	(*21)	(*22)	(*23)	(*24)	(*25)	(*26)	(*27)	(*28)	Unit
5.4	5.52	5.4	5.0	4.7	8.2	7.0	6.8	4.5	mW/°C

When using the unit above Ta=25°C, subtract the value above per degree°C. Permissible dissipation is the value.
 When FR4 glass epoxy board 70mm×70mm×1.6mm (cooper foil area below 3%) is mounted.

Figure 84. Thermal resistance and derating

●Operational Notes

- 1) Processing of unused circuit
It is recommended to apply connection (see the Figure 85.) and set the non inverting input terminal at the potential within input common-mode voltage range (Vicm), for any unused circuit.
- 2) Applied voltage to the input terminal
For normal circuit operation of voltage comparator, please input voltage for its input terminal within input common mode voltage $VDD + 0.3V$. Then, regardless of power supply voltage, $VSS - 0.3V$ can be applied to input terminals without deterioration or destruction of its characteristics.
- 3) Short-circuit of output terminal
When output terminal and VDD or VSS terminal are shorted, excessive Output current may flow under some conditions, and heating may destroy IC. It is necessary to connect a resistor as shown in Figure 86, thereby protecting against load shorting.
- 4) Operating power supply (split power supply/single power supply)
The voltage comparator operates if a given level of voltage is applied between VDD and VSS. Therefore, the operational amplifier can be operated under single power supply or split power supply.
- 5) Power dissipation (pd)
If the IC is used under excessive power dissipation. An increase in the chip temperature will cause deterioration of the radical characteristics of IC. For example, reduction of current capability. Take consideration of the effective power dissipation and thermal design with a sufficient margin. Pd is reference to the provided power dissipation curve.
- 6) Short circuits between pins and incorrect mounting
Short circuits between pins and incorrect mounting when mounting the IC on a printed circuits board, take notice of the direction and positioning of the IC. If IC is mounted erroneously, It may be damaged. Also, when a foreign object is inserted between output, between output and VDD terminal and VSS terminal which causes short circuit, the IC may be damaged.
- 7) Using under strong electromagnetic field
Be careful when using the IC under strong electromagnetic field because it may malfunction.
- 8) Usage of IC
When stress is applied to the IC through warp of the printed circuit board, The characteristics may fluctuate due to the piezo effect. Be careful of the warp of the printed circuit board.
- 9) Testing IC on the set board
When testing IC on the set board, in cases where the capacitor is connected to the low impedance, make sure to discharge per fabrication because there is a possibility that IC may be damaged by stress. When removing IC from the set board, it is essential to cut supply voltage. As a countermeasure against the static electricity, observe proper grounding during fabrication process and take due care when carrying and storage it.
- 10) The IC destruction caused by capacitive load
The transistors in circuits may be damaged when VDD terminal and VSS terminal is shorted with the charged output terminal capacitor. When IC is used as a operational amplifier or as an application circuit, where oscillation is not activated by an output capacitor, the output capacitor must be kept below $0.1\mu F$ in order to prevent the damage mentioned above.
- 11) Latch up
Be careful of input voltage that exceed the VDD and VSS. When CMOS device have sometimes occur latch up operation. And protect the IC from abnormaly noise
- 12) Decoupling capacitor
Insert the decoupling capacitance between VDD and VSS, for stable operation of operational amplifier.

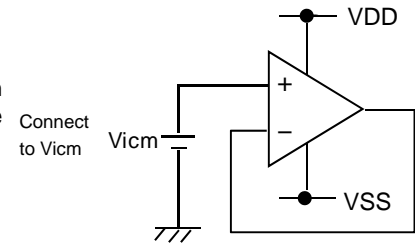

Figure 85. The example of application circuit for unused op-amp

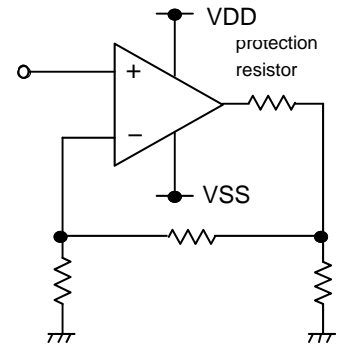

Figure 86. The example of output short protection

Status of this document

The Japanese version of this document is formal specification. A customer may use this translation version only for a reference to help reading the formal version.

If there are any differences in translation version of this document formal version takes priority.

●Physical Dimensions Tape and Reel Information
SSOP5

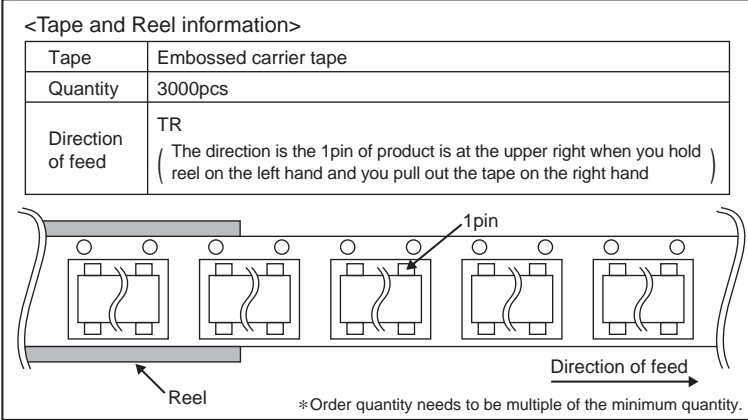
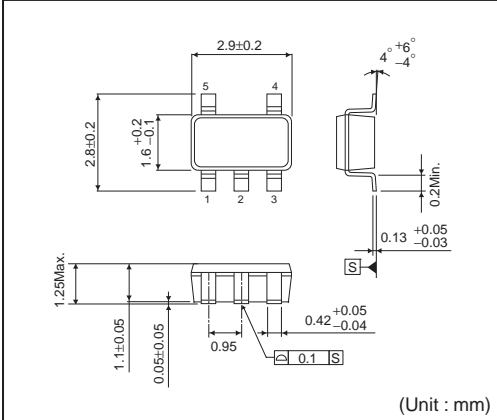

SOP8

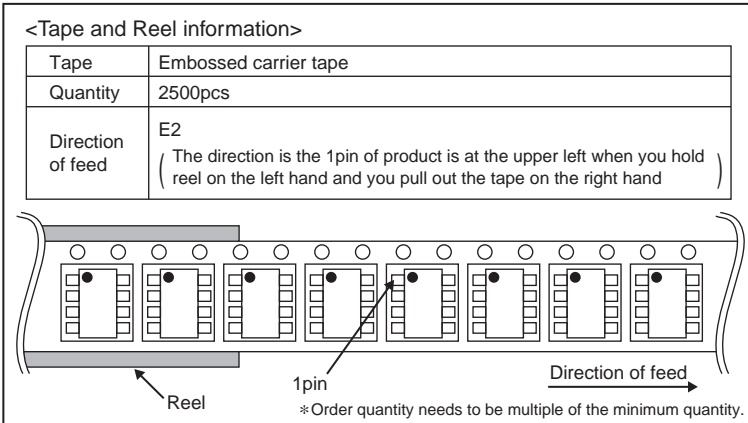
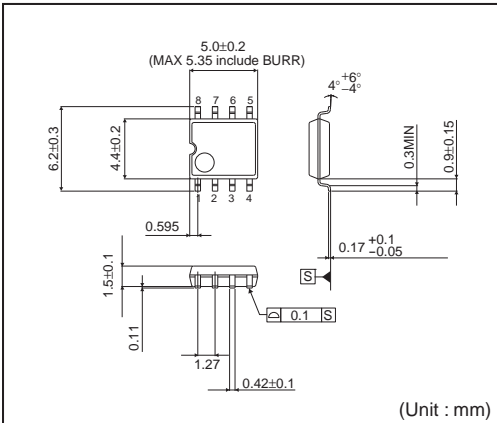

SOP-J8

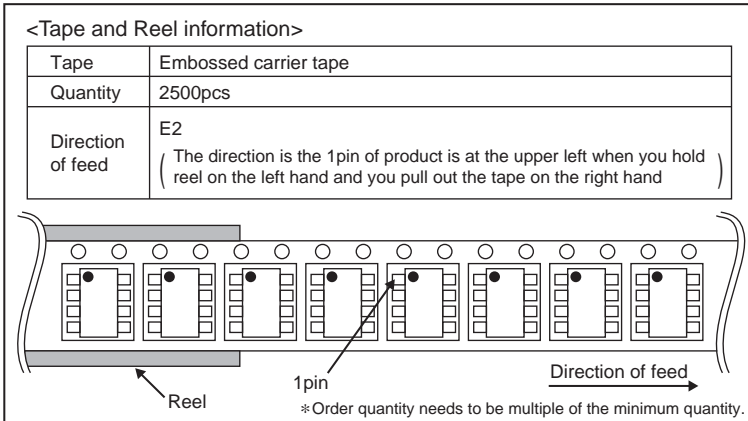
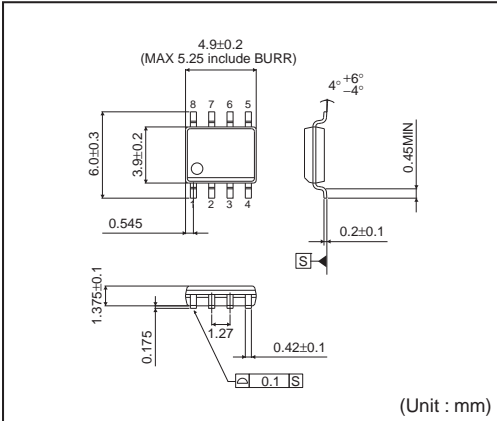

SSOP-B8

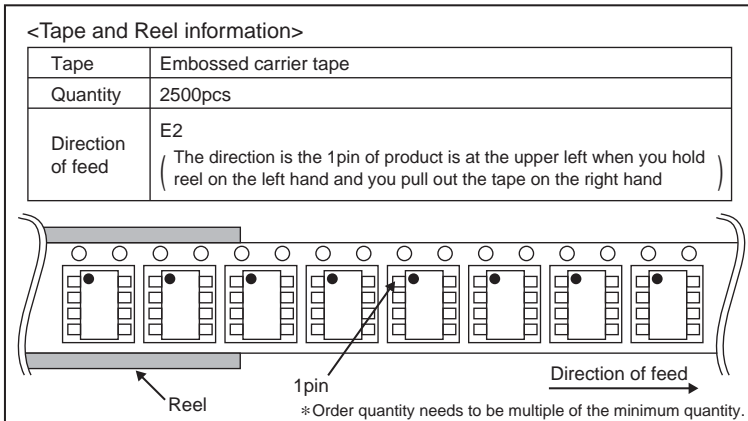
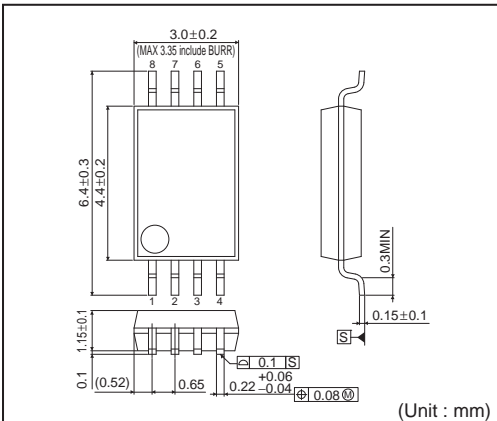

TSSOP-B8

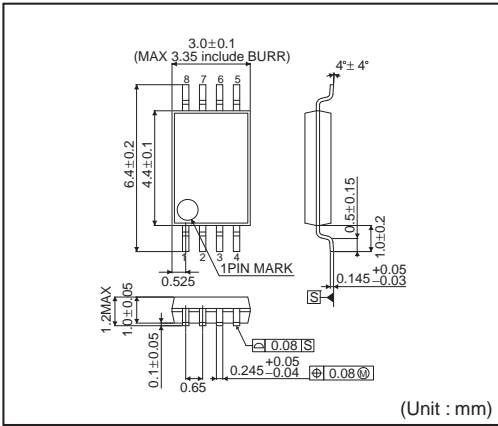

<Tape and Reel information>

Tape	Embossed carrier tape
Quantity	3000pcs
Direction of feed	E2 (The direction is the 1pin of product is at the upper left when you hold reel on the left hand and you pull out the tape on the right hand)

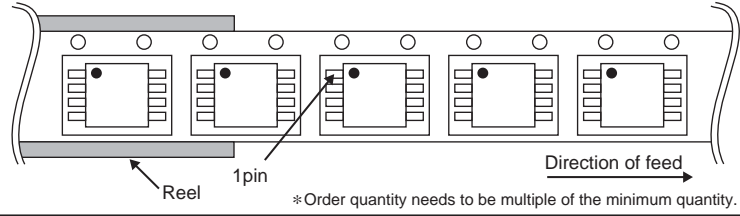

MSOP8

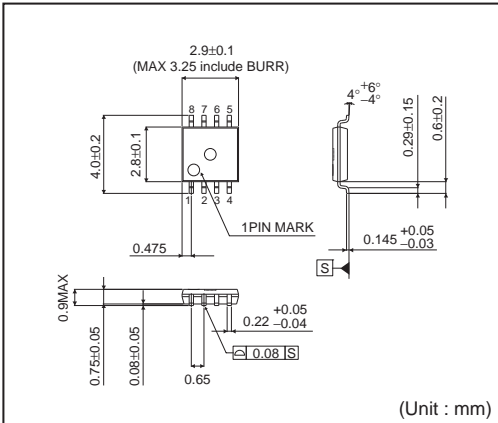

<Tape and Reel information>

Tape	Embossed carrier tape
Quantity	3000pcs
Direction of feed	TR (The direction is the 1pin of product is at the upper right when you hold reel on the left hand and you pull out the tape on the right hand)

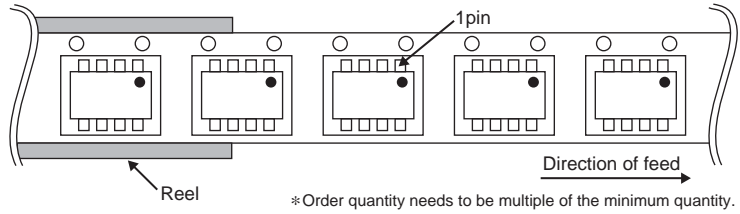

TSSOP-B8J

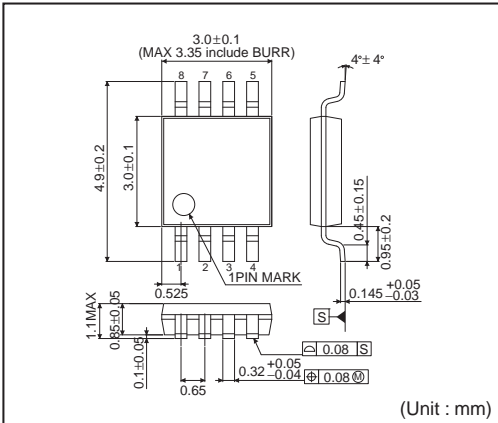

<Tape and Reel information>

Tape	Embossed carrier tape
Quantity	2500pcs
Direction of feed	E2 (The direction is the 1pin of product is at the upper left when you hold reel on the left hand and you pull out the tape on the right hand)

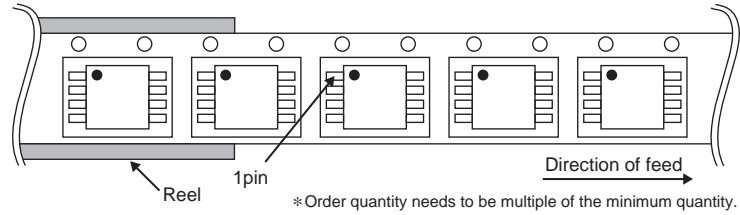

SOP14

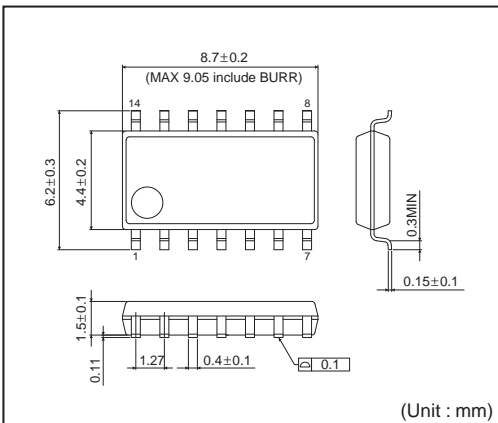

<Tape and Reel information>

Tape	Embossed carrier tape
Quantity	2500pcs
Direction of feed	E2 (The direction is the 1pin of product is at the upper left when you hold reel on the left hand and you pull out the tape on the right hand)

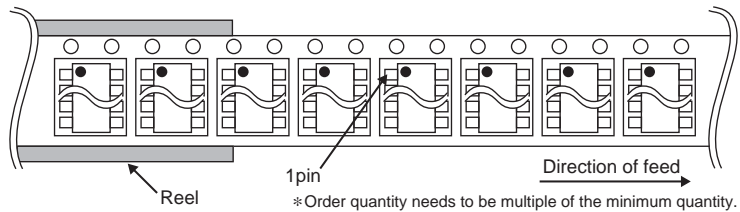

SOP-J14

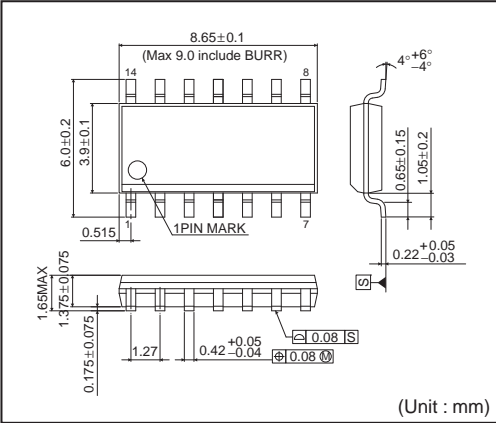

<Tape and Reel information>

Tape	Embossed carrier tape
Quantity	2500pcs
Direction of feed	E2 (The direction is the 1pin of product is at the upper left when you hold reel on the left hand and you pull out the tape on the right hand)

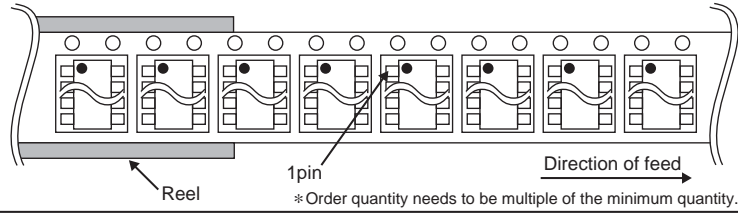

SSOP-B14

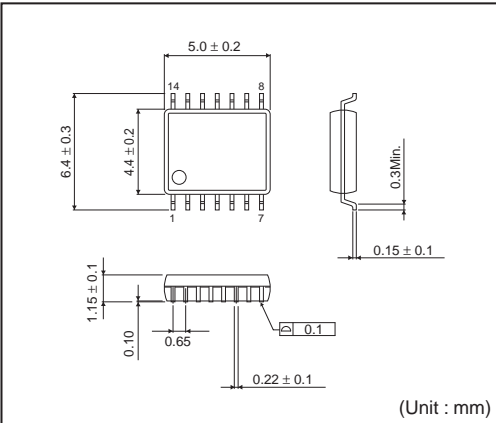

<Tape and Reel information>

Tape	Embossed carrier tape
Quantity	2500pcs
Direction of feed	E2 (The direction is the 1pin of product is at the upper left when you hold reel on the left hand and you pull out the tape on the right hand)

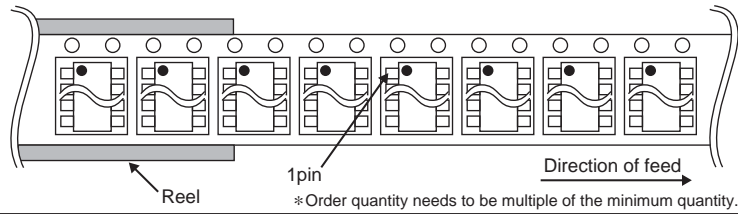

TSSOP-B14J

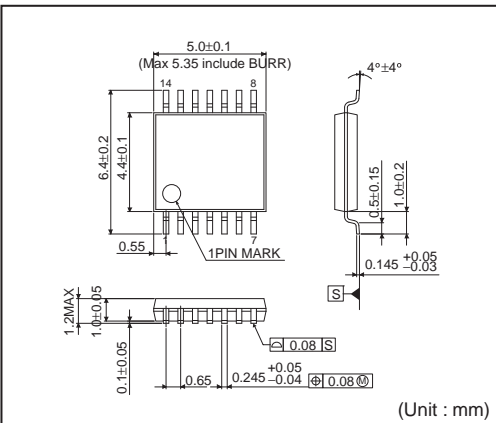

<Tape and Reel information>

Tape	Embossed carrier tape
Quantity	2500pcs
Direction of feed	E2 (The direction is the 1pin of product is at the upper left when you hold reel on the left hand and you pull out the tape on the right hand)

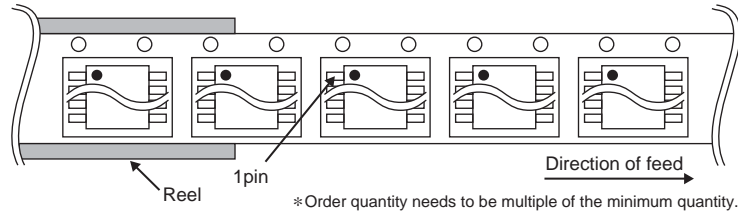

● Marking Diagrams

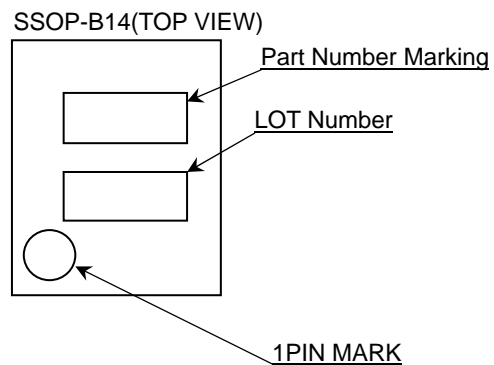
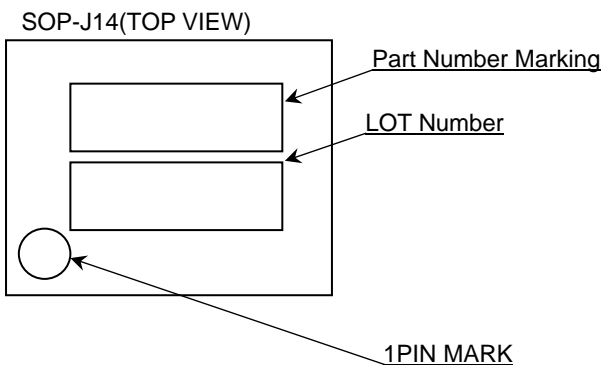
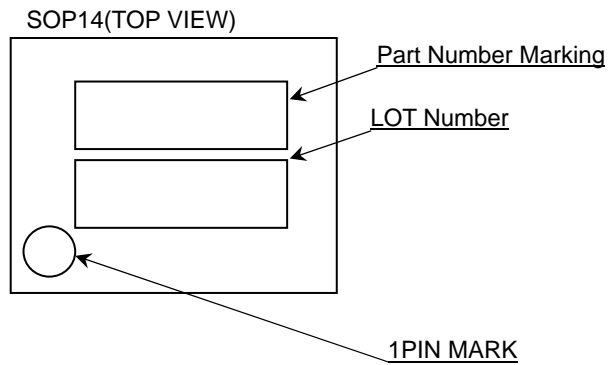
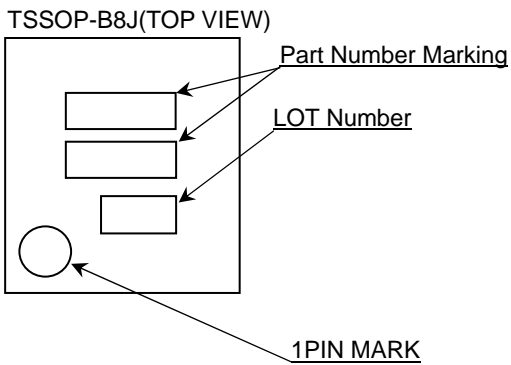
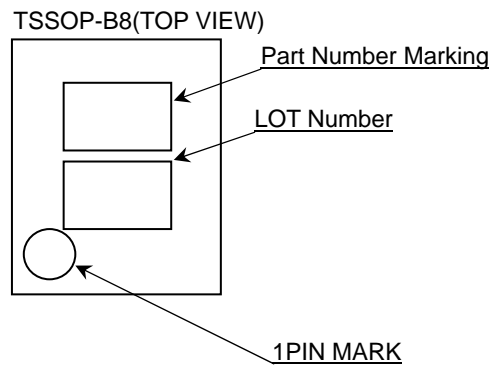
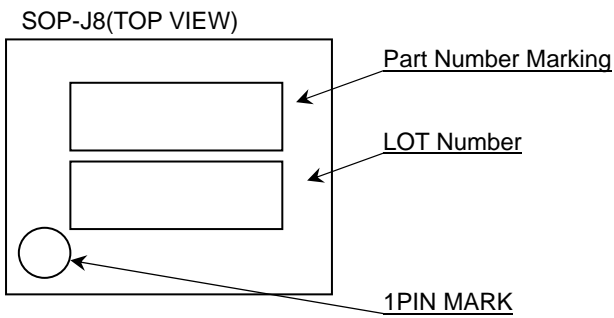
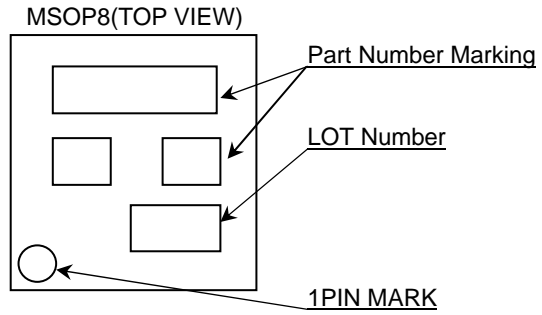
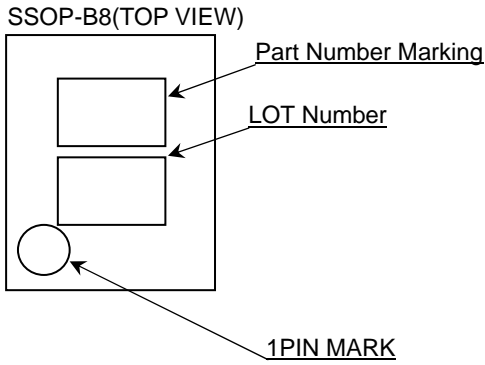
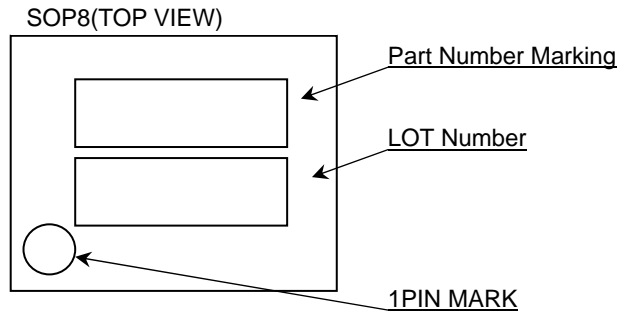
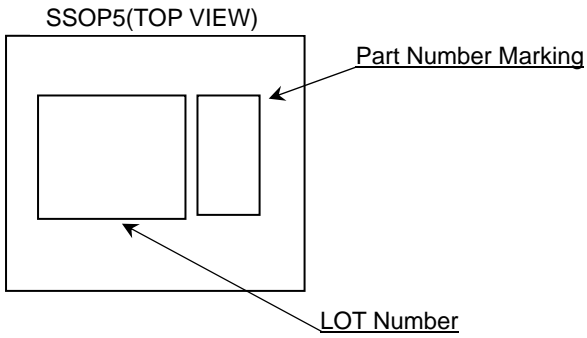

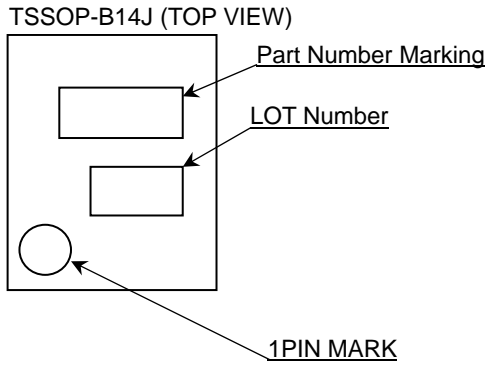

Product Name		Package Type	Product Name Marking
LMR321	G	SSOP5	L2
LMR358	F	SOP8	L358
	FJ	SOP-J8	R358
	FV	SSOP-B8	L358
	FVT	TSSOP-B8	R358
	FVM	MSOP8	L358
	FVJ	TSSOP-B8J	R358
LMR324	F	SOP14	LMR324F
	FJ	SOP-J14	LMR324FJ
	FV	SSOP-B14	L324
	FVJ	TSSOP-B14J	R324

● Land pattern data

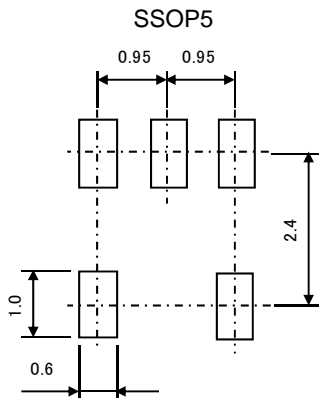

SOP8, SOP14, SOP-J8, SOP-J14, SSOP-B8
SSOP-B14, MSOP8, TSSOP-B8, TSSOP-B8J, TSSOP-B14J

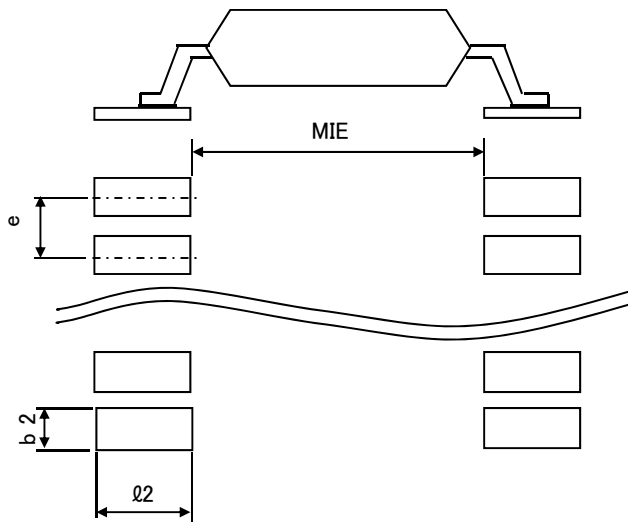

all dimensions in mm

PKG	Land pitch e	Land space MIE	Land length $\geq \varnothing 2$	Land width b2
SSOP5	0.95	2.4	1.0	0.6
SOP8 SOP14	1.27	4.60	1.10	0.76
SOP-J8 SOP-J14	1.27	3.90	1.35	0.76
SSOP-B8 SSOP-B14	0.65	4.60	1.20	0.35
MSOP8	0.65	2.62	0.99	0.35
TSSOP-B8	0.65	4.60	1.20	0.35
TSSOP-B8J	0.65	3.20	1.15	0.35
TSSOP-B14J	0.65	4.60	1.20	0.35

● Revision History

Date	Revision	Changes
30.NOV.2012	001	New Release

Notice

Precaution on using ROHM Products

- Our Products are designed and manufactured for application in ordinary electronic equipments (such as AV equipment, OA equipment, telecommunication equipment, home electronic appliances, amusement equipment, etc.). If you intend to use our Products in devices requiring extremely high reliability (such as medical equipment ^(Note 1), transport equipment, traffic equipment, aircraft/spacecraft, nuclear power controllers, fuel controllers, car equipment including car accessories, safety devices, etc.) and whose malfunction or failure may cause loss of human life, bodily injury or serious damage to property (“Specific Applications”), please consult with the ROHM sales representative in advance. Unless otherwise agreed in writing by ROHM in advance, ROHM shall not be in any way responsible or liable for any damages, expenses or losses incurred by you or third parties arising from the use of any ROHM’s Products for Specific Applications.

(Note1) Medical Equipment Classification of the Specific Applications

JAPAN	USA	EU	CHINA
CLASS III	CLASS III	CLASS II b	CLASS III
CLASS IV		CLASS III	

- ROHM designs and manufactures its Products subject to strict quality control system. However, semiconductor products can fail or malfunction at a certain rate. Please be sure to implement, at your own responsibilities, adequate safety measures including but not limited to fail-safe design against the physical injury, damage to any property, which a failure or malfunction of our Products may cause. The following are examples of safety measures:
 - Installation of protection circuits or other protective devices to improve system safety
 - Installation of redundant circuits to reduce the impact of single or multiple circuit failure
- Our Products are designed and manufactured for use under standard conditions and not under any special or extraordinary environments or conditions, as exemplified below. Accordingly, ROHM shall not be in any way responsible or liable for any damages, expenses or losses arising from the use of any ROHM’s Products under any special or extraordinary environments or conditions. If you intend to use our Products under any special or extraordinary environments or conditions (as exemplified below), your independent verification and confirmation of product performance, reliability, etc. prior to use, must be necessary:
 - Use of our Products in any types of liquid, including water, oils, chemicals, and organic solvents
 - Use of our Products outdoors or in places where the Products are exposed to direct sunlight or dust
 - Use of our Products in places where the Products are exposed to sea wind or corrosive gases, including Cl₂, H₂S, NH₃, SO₂, and NO₂
 - Use of our Products in places where the Products are exposed to static electricity or electromagnetic waves
 - Use of our Products in proximity to heat-producing components, plastic cords, or other flammable items
 - Sealing or coating our Products with resin or other coating materials
 - Use of our Products without cleaning residue of flux (even if you use no-clean type fluxes, cleaning residue of flux is recommended); or Washing our Products by using water or water-soluble cleaning agents for cleaning residue after soldering
 - Use of the Products in places subject to dew condensation
- The Products are not subject to radiation-proof design.
- Please verify and confirm characteristics of the final or mounted products in using the Products.
- In particular, if a transient load (a large amount of load applied in a short period of time, such as pulse. is applied, confirmation of performance characteristics after on-board mounting is strongly recommended. Avoid applying power exceeding normal rated power; exceeding the power rating under steady-state loading condition may negatively affect product performance and reliability.
- De-rate Power Dissipation (Pd) depending on Ambient temperature (Ta). When used in sealed area, confirm the actual ambient temperature.
- Confirm that operation temperature is within the specified range described in the product specification.
- ROHM shall not be in any way responsible or liable for failure induced under deviant condition from what is defined in this document.

Precaution for Mounting / Circuit board design

- When a highly active halogenous (chlorine, bromine, etc.) flux is used, the residue of flux may negatively affect product performance and reliability.
- In principle, the reflow soldering method must be used; if flow soldering method is preferred, please consult with the ROHM representative in advance.

For details, please refer to ROHM Mounting specification

Precautions Regarding Application Examples and External Circuits

1. If change is made to the constant of an external circuit, please allow a sufficient margin considering variations of the characteristics of the Products and external components, including transient characteristics, as well as static characteristics.
2. You agree that application notes, reference designs, and associated data and information contained in this document are presented only as guidance for Products use. Therefore, in case you use such information, you are solely responsible for it and you must exercise your own independent verification and judgment in the use of such information contained in this document. ROHM shall not be in any way responsible or liable for any damages, expenses or losses incurred by you or third parties arising from the use of such information.

Precaution for Electrostatic

This Product is electrostatic sensitive product, which may be damaged due to electrostatic discharge. Please take proper caution in your manufacturing process and storage so that voltage exceeding the Products maximum rating will not be applied to Products. Please take special care under dry condition (e.g. Grounding of human body / equipment / solder iron, isolation from charged objects, setting of Ionizer, friction prevention and temperature / humidity control).

Precaution for Storage / Transportation

1. Product performance and soldered connections may deteriorate if the Products are stored in the places where:
 - [a] the Products are exposed to sea winds or corrosive gases, including Cl₂, H₂S, NH₃, SO₂, and NO₂
 - [b] the temperature or humidity exceeds those recommended by ROHM
 - [c] the Products are exposed to direct sunshine or condensation
 - [d] the Products are exposed to high Electrostatic
2. Even under ROHM recommended storage condition, solderability of products out of recommended storage time period may be degraded. It is strongly recommended to confirm solderability before using Products of which storage time is exceeding the recommended storage time period.
3. Store / transport cartons in the correct direction, which is indicated on a carton with a symbol. Otherwise bent leads may occur due to excessive stress applied when dropping of a carton.
4. Use Products within the specified time after opening a humidity barrier bag. Baking is required before using Products of which storage time is exceeding the recommended storage time period.

Precaution for Product Label

QR code printed on ROHM Products label is for ROHM's internal use only.

Precaution for Disposition

When disposing Products please dispose them properly using an authorized industry waste company.

Precaution for Foreign Exchange and Foreign Trade act

Since our Products might fall under controlled goods prescribed by the applicable foreign exchange and foreign trade act, please consult with ROHM representative in case of export.

Precaution Regarding Intellectual Property Rights

1. All information and data including but not limited to application example contained in this document is for reference only. ROHM does not warrant that foregoing information or data will not infringe any intellectual property rights or any other rights of any third party regarding such information or data. ROHM shall not be in any way responsible or liable for infringement of any intellectual property rights or other damages arising from use of such information or data.:
2. No license, expressly or implied, is granted hereby under any intellectual property rights or other rights of ROHM or any third parties with respect to the information contained in this document.

Other Precaution



1. This document may not be reprinted or reproduced, in whole or in part, without prior written consent of ROHM.
2. The Products may not be disassembled, converted, modified, reproduced or otherwise changed without prior written consent of ROHM.
3. In no event shall you use in any way whatsoever the Products and the related technical information contained in the Products or this document for any military purposes, including but not limited to, the development of mass-destruction weapons.
4. The proper names of companies or products described in this document are trademarks or registered trademarks of ROHM, its affiliated companies or third parties.

General Precaution



1. Before you use our Products, you are requested to carefully read this document and fully understand its contents. ROHM shall not be in any way responsible or liable for failure, malfunction or accident arising from the use of any ROHM's Products against warning, caution or note contained in this document.
2. All information contained in this document is current as of the issuing date and subject to change without any prior notice. Before purchasing or using ROHM's Products, please confirm the latest information with a ROHM sales representative.
3. The information contained in this document is provided on an "as is" basis and ROHM does not warrant that all information contained in this document is accurate and/or error-free. ROHM shall not be in any way responsible or liable for any damages, expenses or losses incurred by you or third parties resulting from inaccuracy or errors of or concerning such information.

Looking for pricing, stock, or lifecycle information?

Click below to explore more details on WIN SOURCE:

-  [View LMR321G-GTR on WIN SOURCE](#)
-  [Rohm Semiconductor Information](#)

Optimize Your Supply Chain with WIN SOURCE Solutions

-  Global Sourcing Solution
-  Obsolete Management
-  Cost Control Management
-  Shortage Management
-  Alternative Solution
-  Excess Inventory Management