

REV.	DESCRIPTION	DATE	APPROVED
B	Engineering Update w/o Changes	03/01/04	M. C.
C	Removed Optional Locator Pin, Generated SLM-XXX-LP	11/11/04	M. C.
D	Tolerance adjustment @ "SH"	12/06/04	M. C.
E	Removed Material Code	05/21/16	J. C.
F	ECO-1088 Removed SLM-140	04/16/21	A. V.

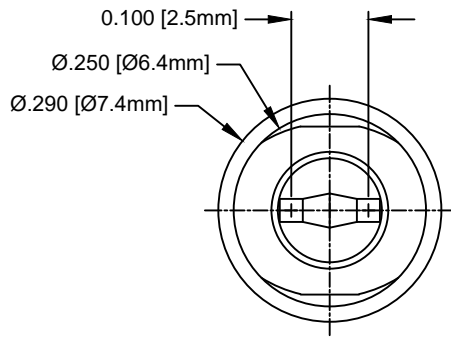

PART NO.	SH (Ref.)	H
SLM-150	.150 (3.8mm)	.295 (7.2mm)
SLM-160	.160 (4.1mm)	.305 (7.7mm)
SLM-170	.170 (4.3mm)	.315 (8.0mm)
SLM-180	.180 (4.6mm)	.325 (8.3mm)
SLM-190	.190 (4.8mm)	.335 (8.5mm)
SLM-200	.200 (5.1mm)	.345 (8.8mm)
SLM-210	.210 (5.3mm)	.355 (9.0mm)
SLM-220	.220 (5.6mm)	.365 (9.3mm)
SLM-230	.230 (5.8mm)	.375 (9.5mm)
SLM-240	.240 (6.1mm)	.385 (9.8mm)
SLM-250	.250 (6.4mm)	.395 (10.0mm)
SLM-260	.260 (6.6mm)	.405 (10.3mm)
SLM-270	.270 (6.9mm)	.415 (10.5mm)
SLM-280	.280 (7.1mm)	.425 (10.8mm)

PART NO.	SH (Ref.)	H
SLM-290	.290 (7.4mm)	.435 (11.0mm)
SLM-300	.300 (7.6mm)	.445 (11.3mm)
SLM-310	.310 (7.9mm)	.455 (11.6mm)
SLM-320	.320 (8.1mm)	.465 (11.8mm)
SLM-330	.330 (8.4mm)	.475 (12.1mm)
SLM-340	.340 (8.6mm)	.485 (12.3mm)
SLM-350	.350 (8.9mm)	.495 (12.6mm)
SLM-360	.360 (9.1mm)	.505 (12.8mm)
SLM-370	.370 (9.4mm)	.515 (13.1mm)
SLM-380	.380 (9.7mm)	.525 (13.3mm)
SLM-390	.390 (9.9mm)	.535 (13.6mm)
SLM-400	.400 (10.2mm)	.545 (13.8mm)
SLM-410	.410 (10.4mm)	.555 (14.1mm)
SLM-420	.420 (10.7mm)	.565 (14.3mm)

PART NO.	SH (Ref.)	H
SLM-430	.430 (10.9mm)	.575 (14.6mm)
SLM-440	.440 (11.2mm)	.585 (14.9mm)
SLM-450	.450 (11.4mm)	.595 (15.1mm)
SLM-470	.470 (11.9mm)	.615 (15.6mm)
SLM-490	.490 (12.4mm)	.635 (16.1mm)
SLM-510	.510 (13.0mm)	.655 (16.6mm)
SLM-530	.530 (13.5mm)	.675 (17.1mm)
SLM-550	.550 (13.8mm)	.695 (17.5mm)
SLM-570	.570 (14.5mm)	.715 (18.2mm)
SLM-590	.590 (15.0mm)	.735 (18.6mm)
SLM-610	.610 (15.5mm)	.755 (19.2mm)
SLM-630	.630 (16.0mm)	.775 (19.7mm)
SLM-650	.650 (16.5mm)	.795 (20.2mm)

PART NO.	SH (Ref.)	H
SLM-670	.670 (17.0mm)	.815 (20.7mm)
SLM-690	.690 (17.5mm)	.835 (21.2mm)
SLM-710	.710 (18.0mm)	.855 (21.7mm)
SLM-730	.730 (18.5mm)	.875 (22.2mm)
SLM-750	.750 (19.1mm)	.895 (22.7mm)
SLM-770	.770 (19.6mm)	.915 (23.2mm)
SLM-790	.790 (20.1mm)	.935 (23.7mm)
SLM-810	.810 (20.6mm)	.955 (24.3mm)
SLM-830	.830 (21.1mm)	.975 (24.8mm)
SLM-850	.850 (21.6mm)	.995 (25.3mm)
SLM-870	.870 (22.1mm)	1.015 (25.8mm)
SLM-890	.890 (22.6mm)	1.035 (26.3mm)

CUSTOMER USE DRAWING

2. MATERIAL: NYLON 6/6, 94V-0, BLACK.

1. GENERAL SPECIFICATIONS: BIVAR MOLDED COMPONENT SPECIFICATION BV00-E101.

STANDARD TOLERANCE (UNLESS OTHERWISE SPECIFIED)		 BIVAR [®] 4 THOMAS, IRVINE, CA. 92618 TEL: (949) 951-8808 FAX: (949) 951-3974			
DECIMALS	ANGULAR				
.X ± .1	X° ± 1°	TITLE: MOLDED, SELF-RETAINING LED MOUNT			
.XX ± .01					
.XXX ± .005		DESIGNED: M. Chen	DATE: 04/23/03	DRAWING NO: SLM-XXX	REVISION: F
		REVISED: V. Chavez	DATE: 04/16/21	SHEET SIZE A	CAGE CODE: 32559
		CHECKED: A. Valdez	DATE: 04/16/21	SCALE: N/A	SHEET # 1 OF 1
CAD GENERATED DOCUMENT, DO NOT MEASURE DRAWING					

Looking for pricing, stock, or lifecycle information?

Click below to explore more details on WIN SOURCE:

 [View SLM-370 on WIN SOURCE](#)

 [Bivar Inc. Information](#)

Optimize Your Supply Chain with WIN SOURCE Solutions

-  Global Sourcing Solution
-  Obsolete Management
-  Cost Control Management
-  Shortage Management
-  Alternative Solution
-  Excess Inventory Management