



**THE DATASHEET OF
LFCN-9170+**





CERAMIC

Low Pass Filter

LFCN-9170+

50Ω DC¹ to 9170 MHz

FEATURES

- Excellent power handling, 8W
- Small size
- 7 sections
- Temperature stable
- Hermetically sealed
- LTCC construction
- Protected by U.S. Patent 6,943,646

APPLICATIONS

- Electronic warfare (EW)
- Harmonic rejection
- Transmitters/receivers
- Lab use

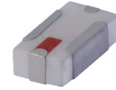

Generic photo used for illustration purposes only

CASE STYLE: FV1206-4

+RoHS Compliant

The +Suffix identifies RoHS Compliance. See our web site for RoHS Compliance methodologies and qualifications

PRODUCT OVERVIEW

Mini-Circuits' LFCN-9170+ is an LTCC low pass filter with a passband from DC to 9170 MHz, supporting a variety of applications. This model provides 1.3 dB typical passband insertion loss and 30 dB typical stopband rejection. It handles up to 8W RF input power and provides a wide operating temperature range from -55 to +100°C. Housed in a tiny 1206 ceramic form factor with wraparound terminations, the filter is ideal for dense PCB layouts and with minimal performance variation due to parasitics.

KEY FEATURES

Feature	Advantages
LTCC Construction	Provides repeatable performance in a rugged, ceramic package well suited for tough environments such as high humidity and temperature extremes.
Tiny size (0.12 x 0.06 x 0.04")	Saves space in dense circuit board layouts and minimizes the effects of parasitics.
High power handling, 8W	Supports a wide range of system power requirements.
Wrap-around terminations	Provides excellent solderability and easy visual inspection
Wide operating temperature range, -55 to +100°C	Enables reliable performance in extreme environments.

REV. B
ECO-011891
LFCN-9170+
BK/CP/AM
220209





CERAMIC

Low Pass Filter

LFCN-9170+

ELECTRICAL SPECIFICATIONS^{1,2} AT 25°C

Parameter	F#	Frequency (MHz)	Min.	Typ.	Max.	Units	
Passband	Insertion Loss	DC-F1	DC-9170	—	1.0	3.0	dB
	Freq. Cut-Off	F2	9800	—	3.0	—	dB
	VSWR	DC-F1	DC-9170	—	1.6	—	:1
Stop Band	Rejection Loss	F3-F4	11360-19000	20	30	—	dB
		F4-F5	11630-18770	28	38	—	dB
	VSWR	F3-F5	11360-19000	—	30	—	:1

1. In Application where DC voltage is present at either input or output ports, de-coupling capacitors are required.

2. Measured on Mini-Circuits Characterization Test Board TB-810+.

MAXIMUM RATINGS

Parameter	Ratings
Operating temperature	-55°C to 100°C
Storage temperature	-55°C to 100°C
RF Power Input ³	8 W max. at 25°C

3. Passband rating, derate linearly to 3W at 100°C ambient. Permanent damage may occur if any of these limits are exceeded.

TYPICAL FREQUENCY RESPONSE

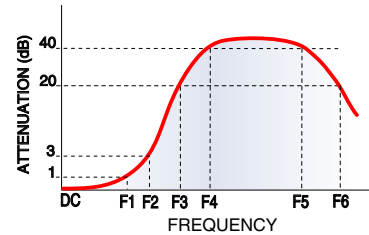

FUNCTIONAL SCHEMATIC

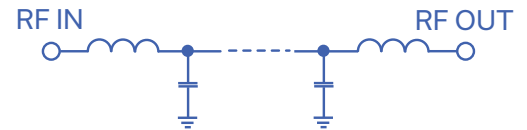



CERAMIC

Low Pass Filter

LFCN-9170+

PIN CONNECTIONS

RF IN	1
RF OUT	3
GROUND	2,4

PRODUCT MARKING: BY

DEMO BOARD MCL P/N: TB-810-9170+
SUGGESTED PCB LAYOUT (PL-546)

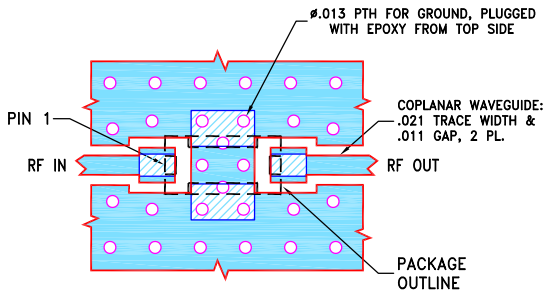

NOTES:

1. TRACE WIDTH & GAP PARAMETERS ARE SHOWN FOR ROGERS RO4350B WITH DIELECTRIC THICKNESS $.010 \pm .001$. COPPER: 1/2 OZ. EACH SIDE. FOR OTHER MATERIALS TRACE WIDTH & GAP MAY NEED TO BE MODIFIED.
2. BOTTOM SIDE OF THE PCB IS CONTINUOUS GROUND PLANE.

- DENOTES PCB COPPER LAYOUT WITH SMOBC (SOLDER MASK OVER BARE COPPER).
- DENOTES COPPER LAND PATTERN FREE OF SOLDER MASK.

OUTLINE DRAWING

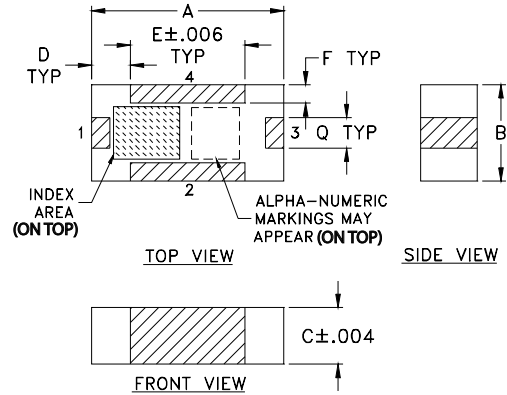

PCB Land Pattern

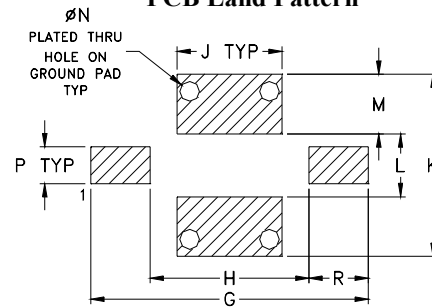

Suggested Layout,
Tolerance to be within $\pm .002$

OUTLINE DIMENSIONS (Inches mm)

A	B	C	D	E	F	G	H	J
.126	.063	.037	.026	.075	.012	.182	.104	.069
3.20	1.60	0.94	0.66	1.91	0.30	4.62	2.64	1.75
K	L	M	N	P	Q	R	wt	
.119	.041	.039	.013	.024	.020	.039	grams	
3.02	1.04	0.99	0.33	0.61	0.51	0.99	.020	

TAPE & REEL INFORMATION: F75



CERAMIC

Low Pass Filter

LFCN-9170+

TYPICAL PERFORMANCE DATA AT 25°C

Frequency (MHz)	Insertion Loss (dB)	VSWR (:1)
1000	0.22	1.31
2000	0.41	1.56
4000	0.42	1.49
6000	0.38	1.12
9160	1.00	1.09
9800	2.90	2.42
10000	5.24	4.20
11360	47.39	27.89
11620	39.43	31.15
12000	37.84	34.46
14000	52.82	59.27
16000	52.35	76.32
18000	45.35	93.87
18760	41.10	113.28
19000	39.35	92.67

LFCN-9170+ INSERTION LOSS

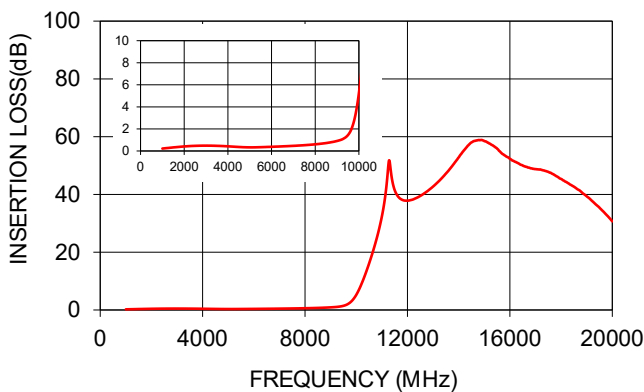

LFCN-9170+ VSWR

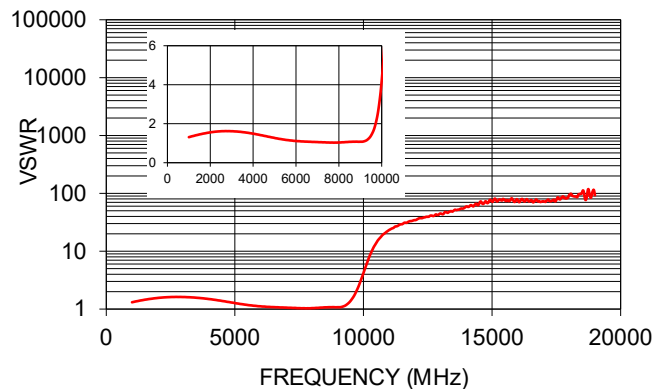

NOTES

- A. Performance and quality attributes and conditions not expressly stated in this specification document are intended to be excluded and do not form a part of this specification document.
- B. Electrical specifications and performance data contained in this specification document are based on Mini-Circuit's applicable established test performance criteria and measurement instructions.
- C. The parts covered by this specification document are subject to Mini-Circuits standard limited warranty and terms and conditions (collectively, "Standard Terms"); Purchasers of this part are entitled to the rights and benefits contained therein. For a full statement of the standard. Terms and the exclusive rights and remedies thereunder, please visit Mini-Circuits' website at www.minicircuits.com/MCLStore/terms.jsp



Looking for pricing, stock, or lifecycle information?

Click below to explore more details on WIN SOURCE:

 [View LFCN-9170+](#) on WIN SOURCE

 [Mini-Circuits](#) Information

Optimize Your Supply Chain with WIN SOURCE Solutions

-  Global Sourcing Solution
-  Obsolete Management
-  Cost Control Management
-  Shortage Management
-  Alternative Solution
-  Excess Inventory Management