



**THE DATASHEET OF
ISL9237IRZR5700**



ISL9237

Buck-Boost Narrow VDC Battery Charger with SMBus Interface and USB OTG

FN8723
Rev.5.00
Nov 29, 2017

The **ISL9237** is a buck-boost Narrow Output Voltage DC (NVDC) charger utilizing Intersil's advanced R3™ Technology to provide high light-load efficiency, fast transient response and seamless DCM/CCM transitions for a variety of mobile and industrial applications.

In Charge mode, the ISL9237 takes input power from a wide range of DC power sources (conventional AC/DC charger adapters, USB PD ports, travel adapters, etc.) and safely charges battery packs with up to 3 cells in a series configuration.

ISL9237 supports On-the-Go (OTG) function for 2- and 3-cell battery applications. When OTG function is enabled, the ISL9237 operates in the reverse Buck mode to provide 5V at the USB port.

As a NVDC topology charger, it also regulates the system output to a narrow DC range for stable system bus voltage. The system power can be provided from the adapter, battery or a combination of both. The ISL9237 can operate with only a battery, only an adapter or both connected. For Intel IMVP8 compliant systems, the ISL9237 includes PSYS functionality, which provides an analog signal representing total platform power. The PSYS output will connect to a wide range of Intersil IMVP8 core regulators to provide an IMVP8 compliant power domain function.

The ISL9237 has serial communication via SMBus/I²C that allows programming of many critical parameters to deliver a customized solution. These programming parameters include, but are not limited to: Adapter current limit, charger current limit, system voltage setting and trickle charging current limit.

Features

- Buck-boost NVDC charger for 1-, 2- or 3-cell Li-ion batteries
- Input voltage range 3.2V to 23.4V (no dead zone)
- System output voltage 2.4V to 13.824V
- System power monitor PSYS output, IMVP-8 compliant
- Up to 1MHz switching frequency
- LDO output for charger VDD
- Adapter current monitor (AMON)
- Battery discharging current monitor (BMON)
- PROCHOT# open-drain output, IMVP-8 compliant
- Allows trickle charging of depleted battery
- Optional ASGATE FET control
- Ideal diode control in Turbo mode
- Supports OTG function for 2- and 3-cell batteries
- SMBus and auto-increment I²C compatible
- Two-level adapter current limit available
- Pb-free (RoHS compliant)
- Package 4x4 32 Ld QFN

Applications

- Mobile devices with rechargeable batteries
- Industrial devices with rechargeable batteries

Related Literature

- For a full list of related documents please visit our web page - [ISL9237](#) product page

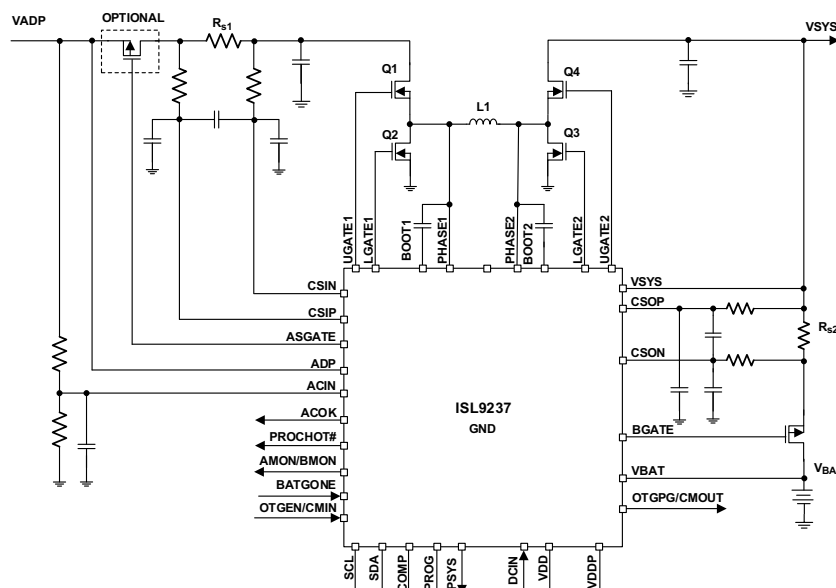

FIGURE 1. TYPICAL APPLICATION CIRCUIT

Table of Contents

Ordering Information	3
Pin Configuration	3
Pin Descriptions	3
Simplified Application Circuit	5
Absolute Maximum Ratings	6
Thermal Information	6
Recommended Operating Conditions	6
Electrical Specifications	6
SMBUS Timing Specification	10
Typical Performance	12
Data Validity	16
START and STOP Conditions	16
Acknowledge	16
SMBus Transactions	16
Byte Format	16
SMBus and I ² C Compatibility	17
ISL9237 SMBus Commands	17
Setting Charging Current Limit	18
Setting Adapter Current Limit	18
Setting Two-Level Adapter Current Limit Duration	19
Setting Maximum Charging Voltage or System Regulating Voltage	20
Setting Minimum System Voltage	20
Setting PROCHOT# Threshold for Adapter Overcurrent Condition	20
Setting PROCHOT# Threshold for Battery Over Discharging Current Condition	21
Setting PROCHOT# Debounce Time and Duration Time	21
Control Registers	21
OTGVoltage Register	24
OTGCurrent Register	25
Information Register	25
Application Information	26
R3™ Modulator	26
ISL9237 Buck-Boost Charger with USB OTG	27
Soft-Start	28
Programming Charger Option	28
DE Operation	29
Power Source Selection	29
Battery Learn Mode	29
Turbo Mode Support	30
Two-Level Adapter Current Limit	30
Current Monitor	30
PSYS Monitor	30
Trickle Charging	31
System Voltage Regulation	31
Charger Timeout	31
USB OTG (On-the-Go)	31
Stand-Alone Comparator	31
System Overvoltage Protection	33
Way Overcurrent Protection (WOCP)	33
Over-Temperature Protection	33
Switching Power MOSFET Gate Capacitance	33
Adapter Input Filter	33
Select the LC Output Filter	34
Select the Input Capacitor	34
Layout Guidelines	37
Revision History	39
About Intersil	39
Package Outline Drawing	40

Ordering Information

PART NUMBER (Notes 1, 2, 3)	PART MARKING	TEMP. RANGE (°C)	PACKAGE (RoHS Compliant)	PKG. DWG. #
ISL9237HRZ	923 7HRZ	-10 to +100	32 Ld 4x4 QFN	L32.4x4A
ISL9237EVAL2Z	Evaluation Board			

NOTES:

- Add "-T" suffix for 6k unit, "-TK" suffix for 1k unit, or "-T7A" suffix for 250 unit Tape and Reel options. Please refer to [TB347](#) for details on reel specifications.
- These Intersil Pb-free plastic packaged products employ special Pb-free material sets, molding compounds/die attach materials, and 100% matte tin plate plus anneal (e3 termination finish, which is RoHS compliant and compatible with both SnPb and Pb-free soldering operations). Intersil Pb-free products are MSL classified at Pb-free peak reflow temperatures that meet or exceed the Pb-free requirements of IPC/JEDEC J STD-020.
- For Moisture Sensitivity Level (MSL), please see product information page for [ISL9237](#). For more information on MSL, please see tech brief [TB363](#).

Pin Configuration

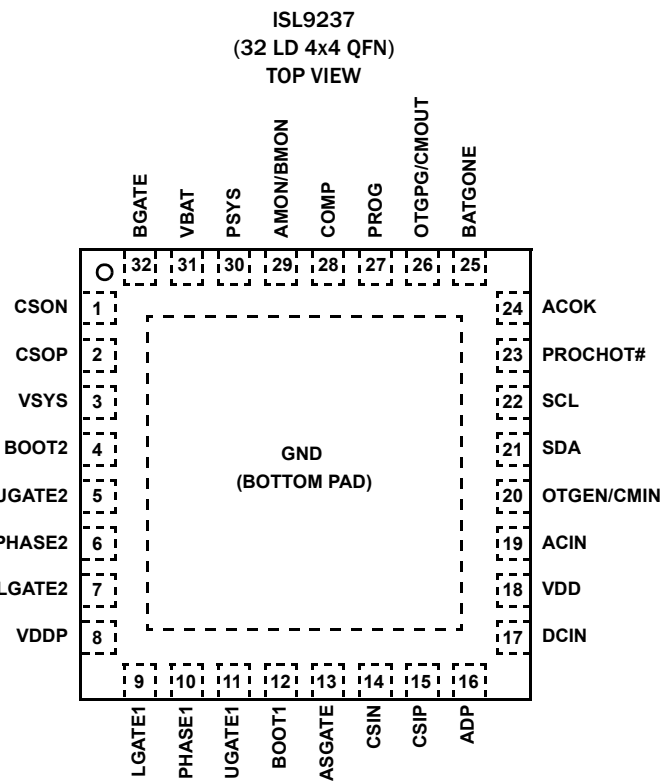

Pin Descriptions

PIN NUMBER	PIN NAME	DESCRIPTION
BOTTOM PAD	GND	Signal common of the IC. Unless otherwise stated, signals are referenced to the GND pin. It should also be used as the thermal pad for heat dissipation.
1	CSON	Battery current sense "-" input. Connect to battery current resistor negative input. Place a 0.1µF ceramic capacitor between CSOP to CSON to provide differential mode filtering.
2	CSOP	Battery current sense "+" input. Connect to battery current resistor positive input. Place a 0.1µF ceramic capacitor between CSOP to CSON to provide differential mode filtering.
3	VSYS	Provides feedback voltage for MaxSystemVoltage regulation.

Pin Descriptions (Continued)

PIN NUMBER	PIN NAME	DESCRIPTION
4	BOOT2	High-side MOSFET Q4 gate driver supply. Connect an MLCC capacitor across the BOOT2 pin and the PHASE2 pin. The boot capacitor is charged through an internal boot diode connected from the VDDP pin to the BOOT2 pin when the PHASE2 pin drops below VDDP minus the voltage drop across the internal boot diode.
5	UGATE2	High-side MOSFET Q4 gate drive.
6	PHASE2	Current return path for the high-side MOSFET Q4 gate drive. Connect this pin to the node consisting of the high-side MOSFET Q4 source, the low-side MOSFET Q3 drain and the one terminal of the inductor.
7	LGATE2	Low-side MOSFET Q3 gate drive.
8	VDDP	Power supply for the gate drivers. Connect to VDD pin through a 4.7Ω resistor and connect a 1μF ceramic capacitor to GND.
9	LGATE1	Low-side MOSFET Q2 gate drive.
10	PHASE1	Current return path for the high side MOSFET Q1 gate drive. Connect this pin to the node consisting of the high-side MOSFET Q1 source, the low-side MOSFET Q2 drain and the input terminal of the inductor.
11	UGATE1	High-side MOSFET Q1 gate drive.
12	BOOT1	High-side MOSFET Q1 gate driver supply. Connect an MLCC capacitor across the BOOT1 pin and the PHASE1 pin. The boot capacitor is charged through an internal boot diode connected from the VDDP pin to the BOOT1 pin when the PHASE1 pin drops below VDDP minus the voltage drop across the internal boot diode.
13	ASGATE	Gate drive output to the P-channel adapter FET. The use of ASGATE FETs is optional, if not used, leave ASGATE pin floating. When ASGATE turns on, it is clamped 10V below ADP pin voltage.
14	CSIN	Adapter current sense “-” input.
15	CSIP	Adapter current sense “+” input. The modulator also uses this for sensing input voltage in forward mode and output voltage in reverse mode.
16	ADP	Adapter input. Used to sense adapter voltage. When adapter voltage is higher than 3.2V, AGATE is turned on. ADP pin is also one of the two internal low power LDO inputs.
17	DCIN	Input of an internal LDO; provides power to the IC. Connect a diode OR from adapter and system outputs. Bypass this pin with an MLCC capacitor.
18	VDD	Output of the internal LDO; provides the bias power for the internal analog and digital circuit. Connect a 1μF ceramic capacitor to GND. If VDD is pulled below 2V for more than 1ms, ISL9237 will reset all the SMBus register values to the default.
19	ACIN	Adapter voltage sense. Use a resistor divider externally to detect adapter voltage. The adapter voltage is valid if the ACIN pin voltage is greater than 0.8V.
20	OTGEN/ CMIN	OTG function enable pin or stand-alone comparator input pin. Pull high to enable OTG function. The OTG function is enabled when the control register is written to select OTG mode and when the battery voltage is above 5.8V. When OTG function is not selected, this pin is the general purpose stand-alone comparator input.
21	SDA	SMBus data I/O. Connect to the data line from the host controller or smart battery. Connect a 10k pull-up resistor according to SMBus specification.
22	SCL	SMBus clock I/O. Connect to the clock line from the host controller or smart battery. Connect a 10k pull-up resistor according to SMBus specification.
23	PROCHOT#	Open-drain output. Pulled low when ACProchot#, DCProchot# or Low_VSYS event is detected. IMVP-8 compliant.
24	ACOK	Adapter presence indicator output to indicate the adapter is ready.
25	BATGONE	Input pin to the IC. Logic high on this pin indicates the battery has been removed. Logic low on this pin indicates the battery is present. BATGONE pin logic high will force BGATE FET to turn off in any circumstance.
26	OTGPG/ CMOUT	Open-drain output. OTG function output power-good indicator or the stand-alone comparator output. When OTG function is enabled, low if OTG output voltage is not within regulation window. When OTG function is not used, it is the general purpose comparator output.

Pin Descriptions (Continued)

PIN NUMBER	PIN NAME	DESCRIPTION
27	PROG	A resistor from PROG pin to GND sets the following configurations: 1. Default number of the battery cells in series, 1-, 2- or 3-cell. 2. Default switching frequency 733kHz or 1MHz. 3. Default adapter current limit value 0.476A or 1.5A. Refer to Table 18 for programming options.
28	COMP	Error amplifier output. Connect a compensation network externally from COMP to GND.
29	AMON/ BMON	Adapter current monitor output or battery discharging current monitor output. $V_{AMON} = 18 \times (V_{CSIP} - V_{CSIN})$; $V_{BMON} = 18 \times (V_{CSON} - V_{CSOP})$
30	PSYS	Current source output that indicates the whole platform power consumption.
31	VBAT	Battery voltage sensing. Used for trickle charging detection and ideal diode mode control. The VBAT pin is also one of the two internal low power LDO inputs.
32	BGATE	Gate drive output to the P-channel FET connecting the system and the battery. This pin can go high to disconnect the battery, low to connect the battery or operate in a linear mode to regulate trickle charge current during trickle charge. ISL9237 pulls down BGATE to GND to turn on BGATE PFET. Therefore, BGATE PFET gate-to-source voltage rating should be higher than the battery voltage.

Simplified Application Circuit

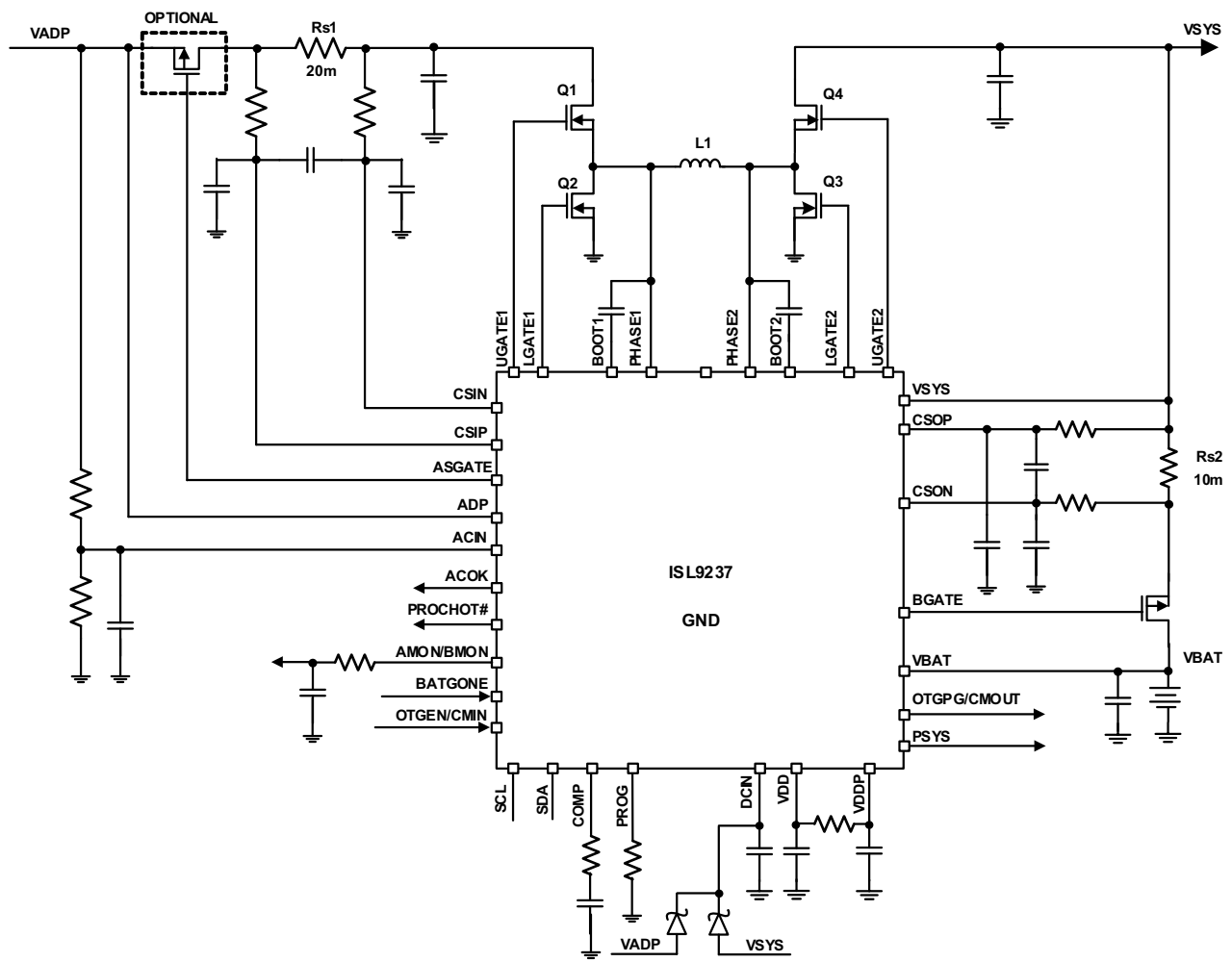

FIGURE 2. SIMPLIFIED APPLICATION DIAGRAM

Absolute Maximum Ratings

CSIP, CSIN, DCIN, ADP, ASGATE	-0.3V to +28V
PHASE1	(GND - 0.3V) to +28V
PHASE1	GND-2V(<20ns) to +28V
BOOT1, UGATE1	(GND - 0.3V) to +33V
PHASE2	(GND - 0.3V) to +15V
PHASE2	GND - 2V(<20ns) to +15V
BOOT2, UGATE2	(GND - 0.3V) to +20V
LGATE1, LGATE2	(GND - 0.3V) to +6.5V
LGATE1, LGATE2	GND - 2V(<20ns) to +6.5V
VBAT, VSYS, CSOP, CSON, BGATE	-0.3V to +15V
VDD, VDDP	-0.3V to +6.5V
COMP	-0.3V to +6.5V
AMON/BMON, PSYS	-0.3V to +6.5V
OTGEN, BATGONE	-0.3V to +6.5V
ACIN, ACOK, PROCHOT#, OTGPG	-0.3V to +6.5V
CLK, DAT	-0.3V to +6.5V
BOOT1-PHASE1, BOOT2-PHASE2	-0.3V to +6.5V
CSIP-CSIN, CSOP-CSON	-0.5V to +0.5V
VDD	70mA
ACIN, SDA, SCL, DCIN, ACOK	2mA
ESD Rating		
Human Body Model (Tested per JESD22-A114E)	2kV
Machine Model (Tested per JESD22-A115-A)	200V
Charged Device Model (Tested per JESD22-C101A)	1kV
Latch-Up (Tested per JESD-78B; Class 2, Level A)	100mA

CAUTION: Do not operate at or near the maximum ratings listed for extended periods of time. Exposure to such conditions may adversely impact product reliability and result in failures not covered by warranty.

NOTES:

- θ_{JA} is measured in free air with the component mounted on a high effective thermal conductivity test board with "direct attach" features. See Tech Brief [TB379](#).
- For θ_{JC} , the "case temp" location is the center of the ceramic on the package underside.

Electrical Specifications Operating conditions: ADP = CSIP = CSIN = 5V and 20V, VSYS = V_{BAT} = CSOP = CSON = 8V, unless otherwise noted. **Boldface limits apply across the junction temperature range, -10°C to +125°C unless otherwise specified.**

PARAMETER	SYMBOL	TEST CONDITIONS	MIN (Note 6)	TYP	MAX (Note 6)	UNIT
UVLO/ACOK						
VADP UVLO Rising (Note 7)	VADP_UVLO_r		3.1	3.2	3.4	V
VADP UVLO Hysteresis (Note 7)	VADP_UVLO_h			600		mV
V _{BAT} UVLO Rising	VBAT_UVLO_r		2.30	2.45	2.60	V
V _{BAT} UVLO Hysteresis	VBAT_UVLO_h			350		mV
V _{BAT} 5P8V Rising	VBAT_5P8_r		5.50	5.95	6.45	V
V _{BAT} 5P8V Hysteresis	VBAT_5P8_h			600		mV
VDD 2P7 POR Rising, SMBus and BGATE/BMON Active Threshold	VDD_2P7_r		2.55	2.70	2.85	V
VDD 2P7 POR Hysteresis (Note 7)	VDD_2P7_h			150		mV
VDD 3P8 POR Rising, Modulator and Gate Driver Active (Note 7)	VDD_3P8_r			3.8		V
VDD 3P8 POR Hysteresis (Note 7)	VDD_3P8_h			150		mV
ACIN Rising	ACIN_r		0.775	0.8	0.825	V
ACIN Hysteresis	ACIN_h			50		mV

Thermal Information

Thermal Resistance (Typical)	θ_{JA} (°C/W)	θ_{JC} (°C/W)
32 Ld QFN Package (Notes 4, 5)	38	3.5
Ambient Temperature Range (T _A)	-10°C to +100°C	
Junction Temperature Range (T _J)	-10°C to +150°C	
Storage Temperature Range (T _S)	-65°C to +175°C	
Pb-Free Reflow Profile	see TB493	

Recommended Operating Conditions

Ambient Temperature	-10°C to +100°C
Junction Temperature	-10°C to +125°C

Electrical Specifications Operating conditions: ADP = CSIP = CSIN = 5V and 20V, VSYS = V_{BAT} = CSOP = CSON = 8V, unless otherwise noted. **Boldface limits apply across the junction temperature range, -10°C to +125°C unless otherwise specified. (Continued)**

PARAMETER	SYMBOL	TEST CONDITIONS	MIN (Note 6)	TYP	MAX (Note 6)	UNIT
LINEAR REGULATOR						
VDD Output Voltage	VDD	6V < V _{DCIN} < 23V, no load	4.5	5.0	5.5	V
VDD Dropout Voltage	VDD_dp	30mA, V _{DCIN} = 4V		110		mV
VDD Overcurrent Threshold	VDD_OC		40	70	110	mA
Battery Current	I _{BAT1}	Battery only, BGATE on, PSYS OFF, BMON OFF, V _{BAT} = 12V, DCIN current comes from battery, I _{BAT} = I _{VBAT} + I _{CSOP} + I _{CSON} + I _{DCIN} + I _{VSYS}		12	30	μA
	I _{BAT2}	Battery only, BGATE on, PSYS OFF, BMON ON, V _{BAT} = 12V, DCIN current comes from battery, I _{BAT} = I _{VBAT} + I _{CSOP} + I _{CSON} + I _{DCIN} + I _{VSYS}		74		μA
	I _{BAT3}	Battery only, BGATE on, PSYS ON, BMON OFF, V _{BAT} = 12V, DCIN current comes from battery, I _{BAT} = I _{VBAT} + I _{CSOP} + I _{CSON} + I _{DCIN} + I _{VSYS}		940	1025	μA
INPUT CURRENT REGULATION, R_{s1} = 20mΩ						
Input Current Accuracy		CSIP - CSIN = 80mV		4		A
			-2		2	%
		CSIP - CSIN = 40mV		2		A
			-2.5		2.5	%
CSIP - CSIN = 10mV		0.5		A		
	-10		10	%		
Adapter Current PROCHOT# Threshold R _{s1} = 20mΩ	I _{ADP_HOT_TH10}	ACProchot = 0x0A80H (2688mA)		2688		mA
			-3.0		3.0	%
		ACProchot = 0x0400H (1024mA)		1027		mA
			-6.0		6.0	%
VOLTAGE REGULATION						
Maximum System Voltage Regulation Accuracy		MaxSystemVoltage for 1-cell, (4.2V)	-0.75		0.75	%
		MaxSystemVoltage for 2-cell and 3-cell	-0.50		0.50	%
Minimum System Voltage Regulation Accuracy			-3		3	%
Input Voltage Regulation Accuracy			-3		3	%
CHARGE CURRENT REGULATION, R_{s2} = 10mΩ						
Charge Current Accuracy		CSOP - CSON = 60mV		6		A
			-2.5		2.5	%
		CSOP - CSON = 20mV		2		A
			-5		5	%
		CSOP - CSON = 10mV		1		A
			-10		10	%
CSOP - CSON = 5mV		0.5		A		
			-20		20	%

Electrical Specifications Operating conditions: ADP = CSIP = CSIN = 5V and 20V, V_{SY}S = V_{BAT} = CSOP = CSON = 8V, unless otherwise noted. **Boldface limits apply across the junction temperature range, -10°C to +125°C unless otherwise specified. (Continued)**

PARAMETER	SYMBOL	TEST CONDITIONS	MIN (Note 6)	TYP	MAX (Note 6)	UNIT
TRICKLE CHARGING CURRENT REGULATION, R_{s2} = 10mΩ						
Trickle Charge Current Accuracy		Trickle, options 256mA and 512mA	-20		20	%
		Trickle, option 128mA	-30		30	%
Fast Charge to Trickle Charge Threshold		V _{BGATE} rising	1.5	1.7	1.9	V
Trickle Charge to Fast Charge Threshold Hysteresis			65	92	125	mV
IDEAL DIODE MODE						
Entering Ideal Diode Mode V _{SY} S Voltage Threshold		BGATE off, V _{SY} S falling V _{BAT} - V _{SY} S		150		mV
Exiting Ideal Diode Mode Battery Current Threshold		R _{s2} = 10mΩ		150		mA
BGATE Source		V _{SY} S - BGATE = 2V	12	17	20	mA
BGATE Sink		BGATE - GND = 2V	4	6	10	mA
AMON/BMON						
INPUT CURRENT SENSE AMPLIFIER, R_{s1} = 20mΩ						
AMON Gain				17.91		V/V
AMON Accuracy V _{AMON} = 17.91 (CSIP - CSIN)		V _{CSIP} - V _{CSIN} = 100mV (5A), CSIP = 5V, 20V	-2		2	%
		V _{CSIP} - V _{CSIN} = 20mV (1A), CSIP = 5V, 20V	-5.0	0.4	5.0	%
		V _{CSIP} - V _{CSIN} = 10mV (0.5A), CSIP = 5V, 20V	-10	1	10	%
		V _{CSIP} - V _{CSIN} = 2mV (0.1A), CSIP = 5V, 20V	-40	4	40	%
AMON Minimum Output Voltage		V _{CSIP} - V _{CSIN} = 0V			30	mV
DISCHARGE CURRENT SENSE AMPLIFIER, R_{s2} = 10mΩ						
BMON Gain				17.95		V/V
BMON Accuracy V _{BMON} = 17.95 (V _{CSON} - V _{CSOP})		V _{CSON} - V _{CSOP} = 100mV (10A), V _{CSON} = 8V	-2.00	-0.15	2.00	%
		V _{CSON} - V _{CSOP} = 20mV (2A), V _{CSON} = 8V	-5.00	-0.68	5.00	%
		V _{CSON} - V _{CSOP} = 10mV (1A), V _{CSON} = 8V	-10.0	-1.3	10.0	%
		V _{CSON} - V _{CSOP} = 6mV (0.6A), V _{CSON} = 8V	-20.0	-2.2	20.0	%
BMON Minimum Output Voltage		V _{CSON} - V _{CSOP} = 0V			30	mV
Discharging Current PROCHOT# Threshold, R _{s2} = 10mΩ	I _{DIS_HOT_TH5}	DCProchot = 0x1000H (4096mA)		4096		mA
			-3		3	%
		DCProchot = 0x0C00H (3072mA)		3072		mA
			-5		5	%
AMON/BMON Source Resistance					5	Ω
AMON/BMON Sink Resistance					5	Ω
ACOK, PROCHOT#, OTGPG/CMOUT (OPEN-DRAIN)						
Open-Drain Current					1	μA
BATGONE AND OTGEN						
High-Level Input Voltage			0.9			V
Low-Level Input Voltage					0.4	V
Input Leakage Current		V _{BATGONE} = 3.3V, 5V; V _{OTGEN} = 3.3V, 5V			1	μA
PROCHOT#						
PROCHOT# Debounce Time (Note 7)		Prochot# Debounce register Bit<1:0> = 11		1		ms
		Prochot# Debounce register Bit<1:0> = 10		500		μs

Electrical Specifications Operating conditions: ADP = CSIP = CSIN = 5V and 20V, VSYS = V_{BAT} = CSOP = CSON = 8V, unless otherwise noted. **Boldface limits apply across the junction temperature range, -10°C to +125°C unless otherwise specified. (Continued)**

PARAMETER	SYMBOL	TEST CONDITIONS	MIN (Note 6)	TYP	MAX (Note 6)	UNIT
PROCHOT# Duration Time (Note 7)		Prochot# Duration register Bit<2:0> = 011		10		ms
		Prochot# Duration register Bit<2:0> = 001		20		ms
Low VSYS PROCHOT# Trip Threshold	V _{LOW_VSYS_HOT}	Control1 register Bit<9:8> = 00	5.8	6.0	6.2	V
		Control1 register Bit<9:8> = 01	6.1	6.3	6.5	V
		Control1 register Bit<9:8> = 10	6.4	6.6	6.8	V
		Control1 register Bit<9:8> = 11	6.7	6.9	7.1	V
PSYS						
PSYS Output Current R _{s1} = 20mΩ R _{s2} = 10mΩ	I _{PSYS}	V _{CSIP} = 19V, V _{CSIP-CSIN} = 80mV, V _{BAT} = 12V, V _{CSOP-CSON} = 0mV		109		μA
			-5		5	%
		V _{CSIP} = 19V, V _{CSIP-CSIN} = 0mV, V _{BAT} = 12V, V _{CSOP-CSON} = 20mV		36		μA
			-6		6	%
		V _{CSIP} = 19V, V _{CSIP-CSIN} = 0mV, V _{BAT} = 8.4V, V _{CSOP-CSON} = -20mV		24		μA
		-7		7	%	
		V _{CSIP} = 0V, V _{CSIP-CSIN} = 0mV, V _{BAT} = 8.4V, V _{CSOP-CSON} = -10mV		12		μA
			-8.5		8.5	%
Maximum PSYS Output Voltage	V _{PSYS_MAX}	I _{PSYS} = 200μA		2		V
OTG						
OTG Voltage		OTGVoltage register = 5.12V	5.04	5.11	5.18	V
OTG Current		OTGCurrent register = 512mA	435	512	589	mA
		OTGCurrent register = 1024mA	922	1024	1126	mA
		OTGCurrent register = 4096mA	3975	4096	4220	mA
GENERAL PURPOSE COMPARATOR						
General Purpose Comparator Rising Threshold		Reference = 1.2V	1.15	1.20	1.25	V
		Reference = 2V	1.95	2.00	2.05	V
General Purpose Comparator Hysteresis		Reference = 1.2V	25	40	65	mV
		Reference = 2V	25	40	65	mV
PROTECTION						
VSYS Overvoltage Rising Threshold		MaxSystemVoltage register value = 8.4V	8.79	8.96	9.18	V
VSYS Overvoltage Hysteresis			185	280	380	mV
Adapter Way Overcurrent Rising Threshold			8	12	18	A
Adapter Way Overcurrent Hysteresis			2.8	3.5	4.2	A
Battery Discharge Way Overcurrent Rising Threshold (Note 7)		R _{s1} = 20mΩ	10	15	24	A
Battery Discharge Way Overcurrent Hysteresis (Note 7)		R _{s2} = 10mΩ	2.56	3.20	3.84	A
Over-Temperature Threshold (Note 7)			140	150	160	°C
Adapter Overvoltage Rising Threshold			22.5	23.4	24	V
Adapter Overvoltage Hysteresis			200	400	600	mV
MISCELLANEOUS						
Switching Frequency Accuracy		All programmed f _{SW} settings	-15		15	%
1MHz Oscillator			0.85	1.00	1.15	MHz
Digital Debounce Time Accuracy (Note 7)			-15		15	%
BGATE_Low Voltage		VSYS = 8V	-10	0	10	mV

Electrical Specifications Operating conditions: ADP = CSIP = CSIN = 5V and 20V, VSYS = V_{BAT} = CSOP = CSON = 8V, unless otherwise noted. **Boldface limits apply across the junction temperature range, -10 °C to +125 °C unless otherwise specified. (Continued)**

PARAMETER	SYMBOL	TEST CONDITIONS	MIN (Note 6)	TYP	MAX (Note 6)	UNIT
ASGATE_Low Voltage Clamp		VADP = 23V, VADP - ASGATE	8	11	12	V
Battery Learn Mode Auto-Exit Threshold		MinSystemVoltage = 5.376V Control1 register Bit<13> = 1	5.05		5.70	V
Battery Learn Mode Auto-Exit Hysteresis (Note 7)			80	160	320	mV
SMBus						
SDA/SCL Input Low Voltage					0.8	V
SDA/SCL Input High Voltage			2			V
SDA/SCL Input Bias Current					1	μA
SDA, Output Sink Current		SDA = 0.4V, on	4			mA
GATE DRIVER (Note 7)						
UGATE1 Pull-Up Resistance	UG1 _{RPU}	100mA source current		800	1200	mΩ
UGATE1 Source Current	UG1 _{SRC}	UGATE1 - PHASE1 = 2.5V	1.3	2		A
UGATE1 Pull-Down Resistance	UG1 _{RPD}	100mA sink current		350	475	mΩ
UGATE1 Sink Current	UG1 _{SNK}	UGATE1 - PHASE1 = 2.5V	1.9	2.8		A
LGATE1 Pull-Up Resistance	LG1 _{RPU}	100mA source current		800	1200	mΩ
LGATE1 Source Current	LG1 _{SRC}	LGATE1 - GND = 2.5V	1.3	2		A
LGATE1 Pull-Down Resistance	LG1 _{RPD}	100mA sink current		300	450	mΩ
LGATE1 Sink Current	LG1 _{SNK}	LGATE1 - GND = 2.5V	2.3	3.5		A
LGATE2 Pull-Up Resistance	LG2 _{RPU}	100mA source current		800	1200	mΩ
LGATE2 Source Current	LG2 _{SRC}	LGATE2 - GND = 2.5V	1.3	2		A
LGATE2 Pull-Down Resistance	LG2 _{RPD}	100mA sink current		300	450	mΩ
LGATE2 Sink Current	LG2 _{SNK}	LGATE2 - GND = 2.5V	2.3	3.5		A
UGATE2 Pull-Up Resistance	UG2 _{RPU}	100mA source current		800	1200	mΩ
UGATE2 Source Current	UG2 _{SRC}	UGATE2 - PHASE2 = 2.5V	1.3	2		A
UGATE2 Pull-Down Resistance	UG2 _{RPD}	100mA sink current		350	475	mΩ
UGATE2 Sink Current	UG2 _{SNK}	UGATE2 - PHASE2 = 2.5V	1.9	2.8		A
UGATE1 to LGATE1 Dead Time	t _{UG1LG1DEAD}		10	20	40	ns
LGATE1 to UGATE1 Dead Time	t _{LG1UG1DEAD}		15	25	45	ns
LGATE2 to UGATE2 Dead Time	t _{LG2UG2DEAD}		15	22	40	ns
UGATE2 to LGATE2 Dead Time	t _{UG2LG2DEAD}		10	20	40	ns

SMBUS Timing Specification (Note 7)

PARAMETERS	SYMBOL	TEST CONDITIONS	MIN (Note 6)	TYP	MAX (Note 6)	UNIT
SMBus Frequency	f _{SMB}		10		400	kHz
Bus Free Time	t _{BUF}		4.7			μs
Start Condition Hold Time from SCL	t _{HD:STA}		4			μs
Start Condition Set-Up Time from SCL	t _{SU:STA}		4.7			μs
Stop Condition Set-Up Time from SCL	t _{SU:STO}		4			μs
SDA Hold Time from SCL	t _{HD:DAT}		300			ns
SDA Set-up Time from SCL	t _{SU:DAT}		250			ns
SCL Low Period	t _{LOW}		4.7			μs
SCL High Period	t _{HIGH}		4			μs

SMBUS Timing Specification (Note 7)

PARAMETERS	SYMBOL	TEST CONDITIONS	MIN (Note 6)	TYP	MAX (Note 6)	UNIT
SMBus Inactivity Timeout		Maximum charging period without a SMBus Write to MaxSystemVoltage or ChargeCurrent register		175		s

NOTES:

- 6. Parameters with MIN and/or MAX limits are 100% tested at +25°C, unless otherwise specified. Temperature limits established by characterization and are not production tested.
- 7. Limits established by characterization and are not production tested.

Buck Mode Gate Driver Timing Diagram

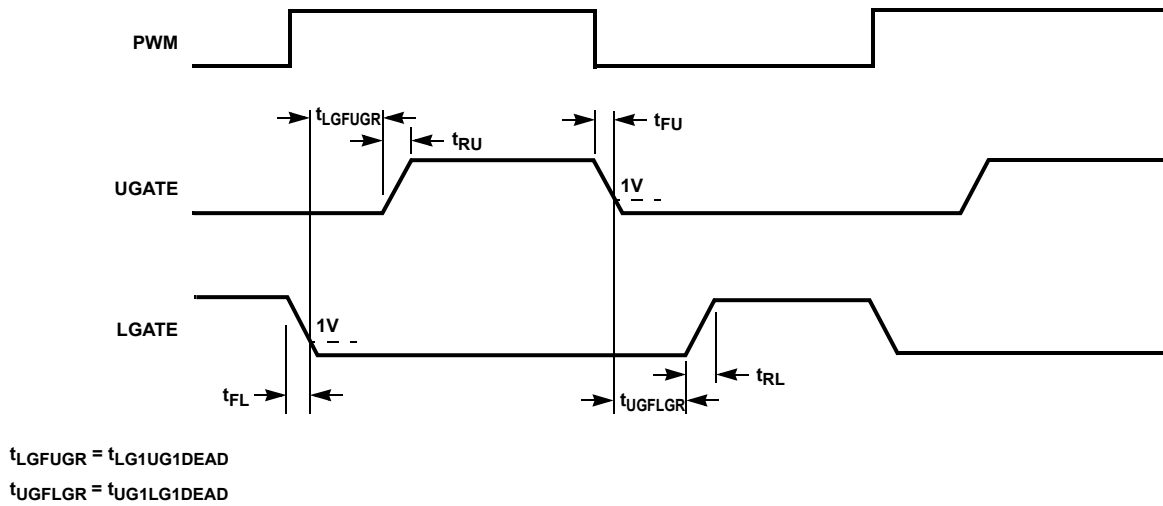

FIGURE 3. BUCK MODE GATE DRIVER TIMING DIAGRAM

Typical Performance

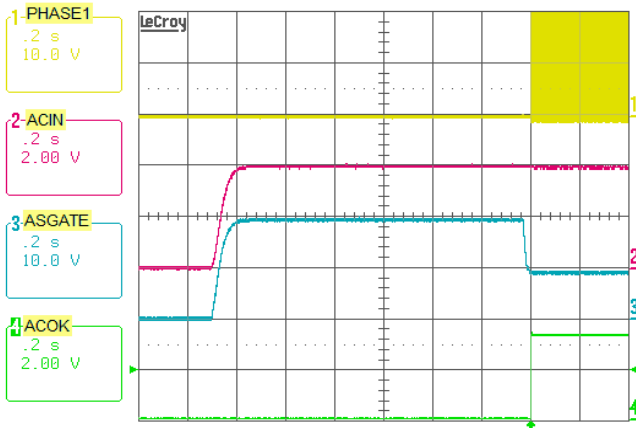

FIGURE 4. ADAPTER INSERTION, $V_{ADP} = 20V$, $V_{BAT} = 7.5V$, CHARGE CURRENT = 0A, ADAPTER INSERTION DEBOUNCE = 1.3s

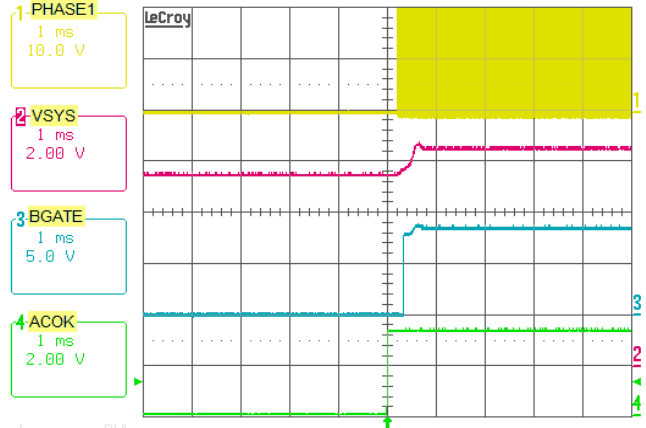

FIGURE 5. ADAPTER INSERTION, $V_{ADP} = 20V$, $V_{BAT} = 7.5V$, CHARGE CURRENT = 0A

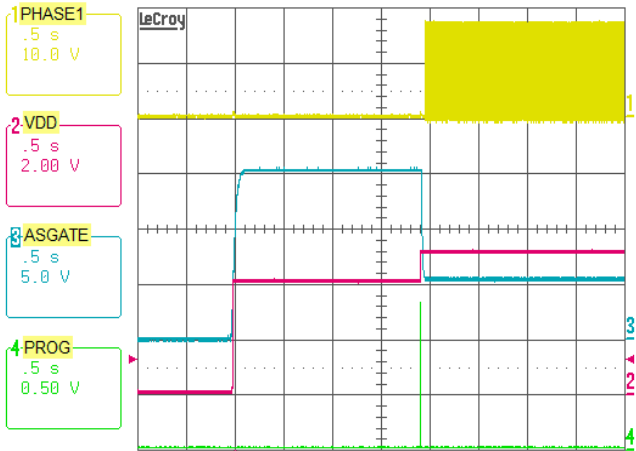

FIGURE 6. ADAPTER INSERTION, $V_{ADP} = 20V$, $V_{BAT} = 7.5V$, CHARGE CURRENT = 0A, ADAPTER INSERTION DEBOUNCE = 1.3s

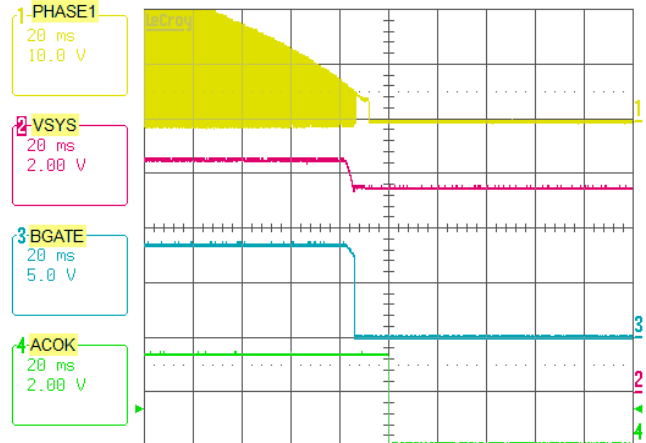

FIGURE 7. ADAPTER REMOVAL, $V_{ADP} = 20V$, $V_{BAT} = 7.5V$, CHARGE CURRENT = 0A

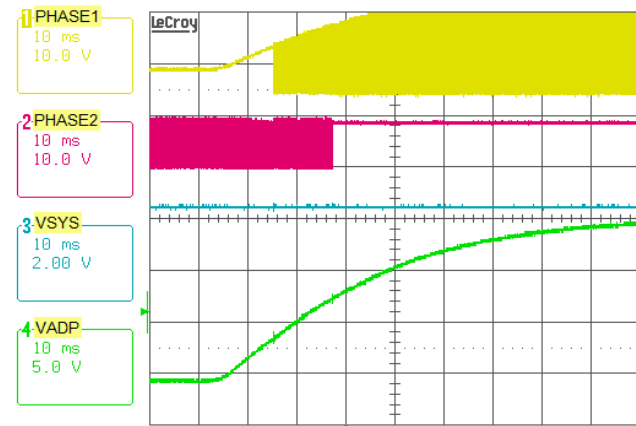

FIGURE 8. ADAPTER VOLTAGE RAMP UP, BOOST -> BUCK-BOOST -> BUCK OPERATION MODE TRANSITION

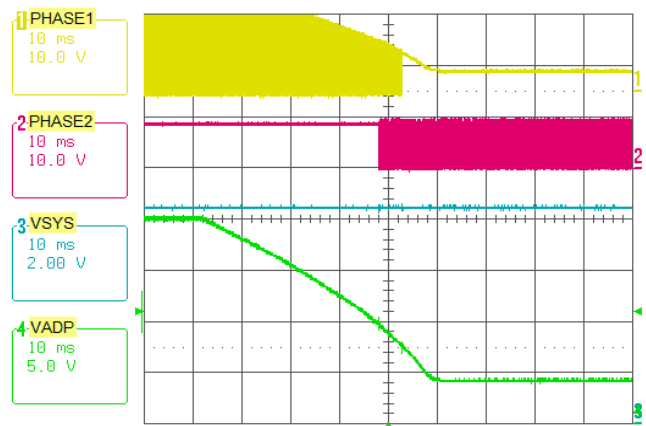

FIGURE 9. ADAPTER VOLTAGE RAMP DOWN, BUCK -> BUCK-BOOST -> BOOST OPERATION MODE TRANSITION

Typical Performance (Continued)

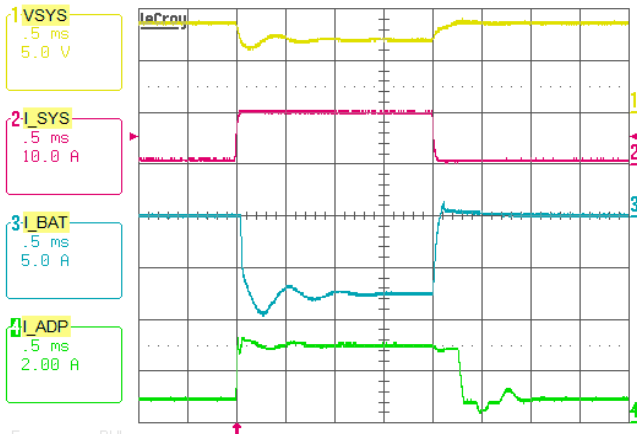

FIGURE 10. BOOST MODE, OUTPUT VOLTAGE LOOP TO ADAPTER CURRENT LOOP TRANSITION. $V_{ADP} = 5V$, $MAXSYSTEMVOLTAGE = 8.496V$, $V_{BAT} = 7V$, SYSTEM LOAD 0.5A TO 10A STEP, $ADAPTERCURRENTLIMIT = 3A$, $CHARGECURRENT = 0A$

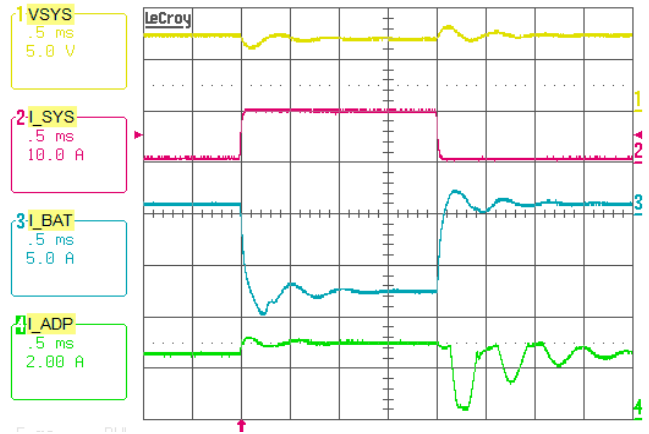

FIGURE 11. BOOST MODE, CHARGING CURRENT LOOP TO ADAPTER CURRENT LOOP TRANSITION. $V_{ADP} = 5V$, $MAXSYSTEMVOLTAGE = 8.496V$, $V_{BAT} = 7V$, SYSTEM LOAD 0.5A TO 10A STEP, $ADAPTERCURRENTLIMIT = 3A$, $CHARGECURRENT = 1A$

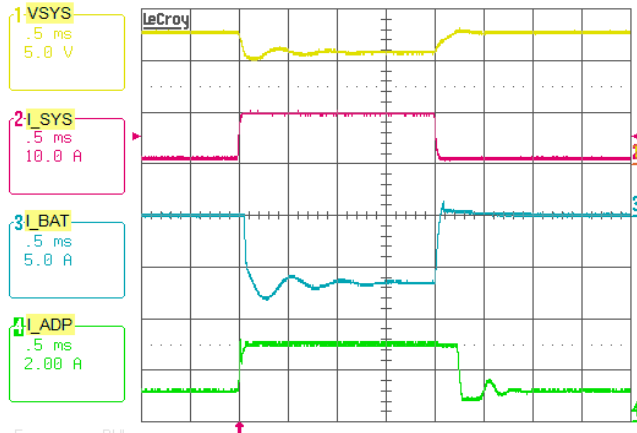

FIGURE 12. BUCK-BOOST MODE, OUTPUT VOLTAGE LOOP TO ADAPTER CURRENT LOOP TRANSITION. $V_{ADP} = 12V$, $MAXSYSTEMVOLTAGE = 12.6V$, $V_{BAT} = 11V$, SYSTEM LOAD 1A TO 10A STEP, $ADAPTERCURRENTLIMIT = 3A$, $CHARGECURRENT = 0A$

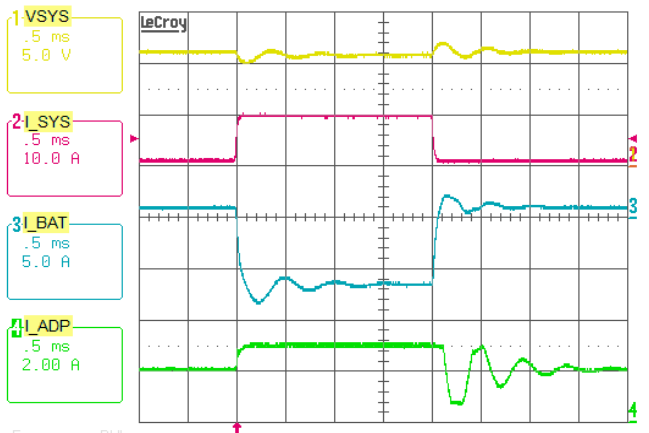

FIGURE 13. BUCK-BOOST MODE, CHARGING CURRENT LOOP TO ADAPTER CURRENT LOOP TRANSITION. $V_{ADP} = 12V$, $MAXSYSTEMVOLTAGE = 12.6V$, $V_{BAT} = 11V$, SYSTEM LOAD 1A TO 10A STEP, $ADAPTERCURRENTLIMIT = 3A$, $CHARGECURRENT = 1A$

Typical Performance (Continued)

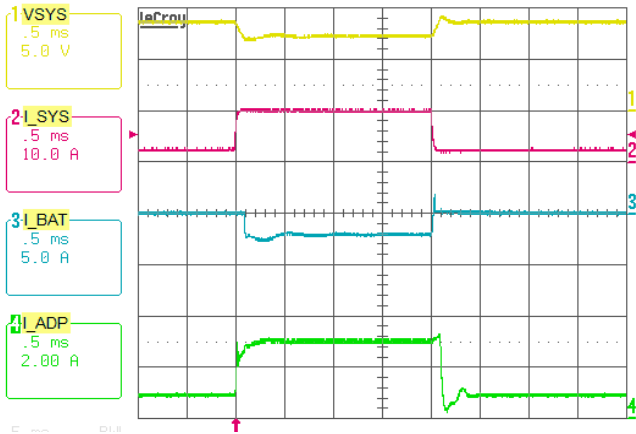

FIGURE 14. BUCK MODE, OUTPUT VOLTAGE LOOP TO ADAPTER CURRENT LOOP TRANSITION. $V_{ADP} = 20V$, $MAXSYSTEMVOLTAGE = 8.496V$, $V_{BAT} = 7V$, SYSTEM LOAD 2A TO 10A STEP, $ADAPTERCURRENTLIMIT = 3A$, $CHARGECURRENT = 0A$

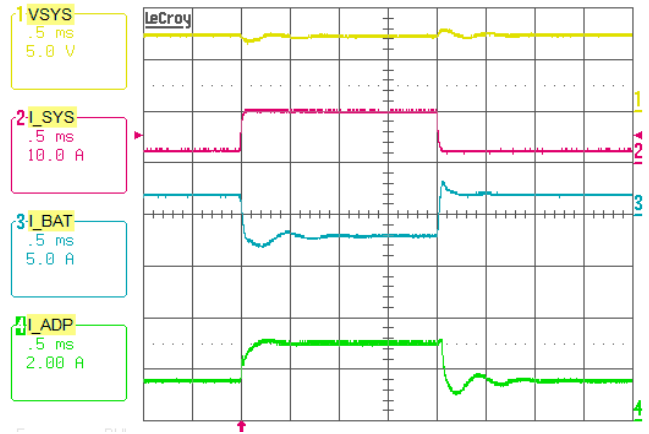

FIGURE 15. BUCK MODE, CHARGING CURRENT LOOP TO ADAPTER CURRENT LOOP TRANSITION. $V_{ADP} = 20V$, $MAXSYSTEMVOLTAGE = 8.496V$, $V_{BAT} = 7V$, SYSTEM LOAD 2A TO 10A STEP, $ADAPTERCURRENTLIMIT = 3A$, $CHARGECURRENT = 2A$

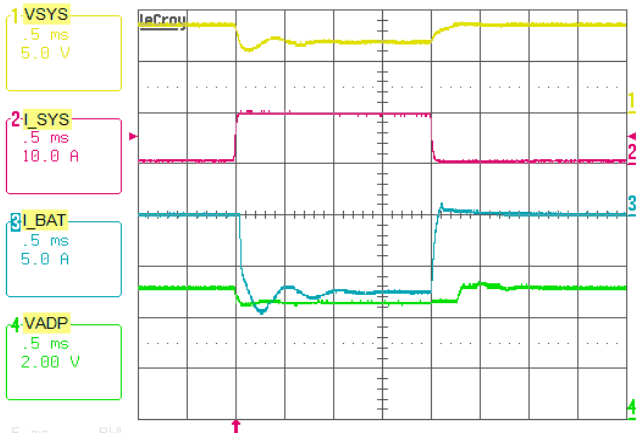

FIGURE 16. BOOST MODE, OUTPUT VOLTAGE LOOP TO INPUT VOLTAGE LOOP TRANSITION. $V_{ADP} = 5V$, $MAXSYSTEMVOLTAGE = 8.496V$, $V_{BAT} = 7V$, $V_{INDAC} = 4.5V$, SYSTEM LOAD 0.5A TO 10A STEP, $CHARGECURRENT = 0A$

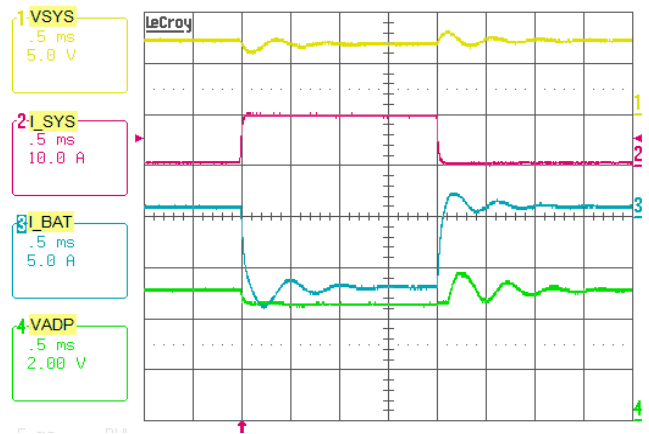

FIGURE 17. BOOST MODE, CHARGING CURRENT LOOP TO INPUT VOLTAGE LOOP TRANSITION. $V_{ADP} = 5V$, $MAXSYSTEMVOLTAGE = 8.496V$, $V_{BAT} = 7V$, $V_{INDAC} = 4.5V$, SYSTEM LOAD 0.5A TO 10A STEP, $CHARGECURRENT = 1A$

Typical Performance (Continued)

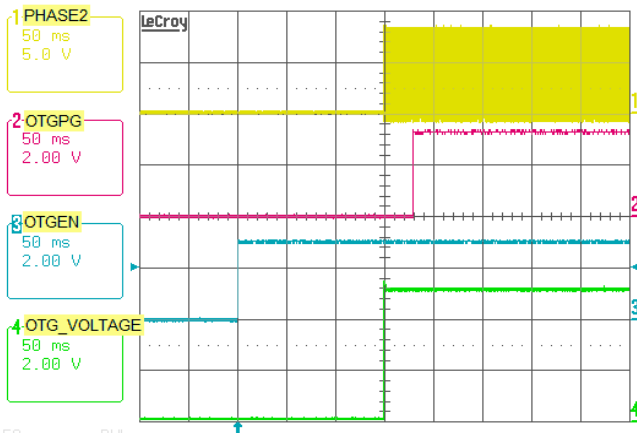

FIGURE 18. OTG MODE ENABLE, OTG ENABLE 150ms DEBOUNCE TIME

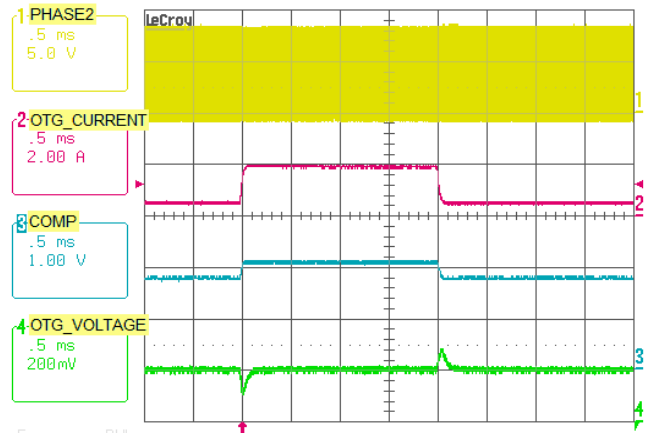

FIGURE 19. OTG MODE 0.5A TO 2A TRANSIENT LOAD, OTG VOLTAGE = 5.12V

General SMBus Architecture

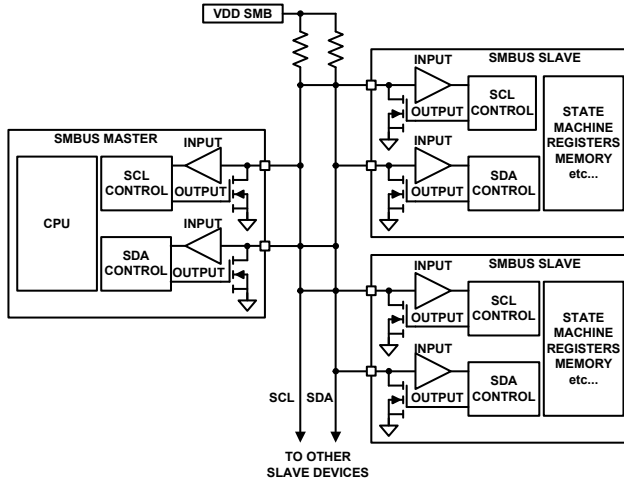

FIGURE 20. GENERAL SMBus ARCHITECTURE

Data Validity

The data on the SDA line must be stable during the HIGH period of the SCL, unless generating a START or STOP condition. The HIGH or LOW state of the data line can only change when the clock signal on the SCL line is LOW. Refer to Figure 21.

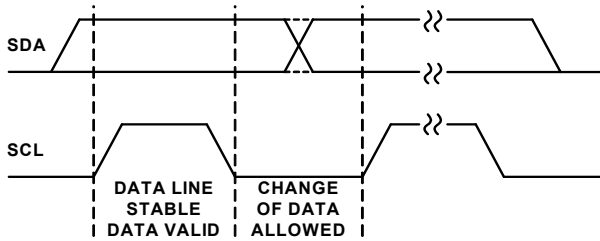

FIGURE 21. DATA VALIDITY

START and STOP Conditions

Figure 22 START condition is a HIGH to LOW transition of the SDA line while SCL is HIGH.

The STOP condition is a LOW to HIGH transition on the SDA line while SCL is HIGH. A STOP condition must be sent before each START condition.

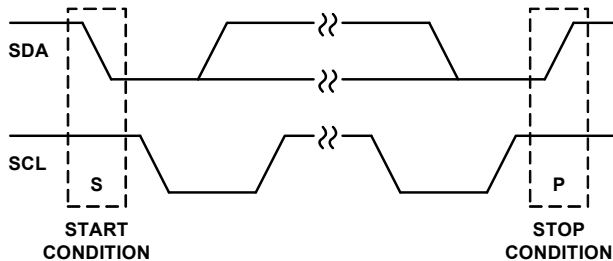

FIGURE 22. START AND STOP WAVEFORMS

Acknowledge

Each address and data transmission uses 9 clock pulses. The ninth pulse is the acknowledge bit (ACK). After the start condition, the master sends 7 slave address bits and a R/W bit during the next 8 clock pulses. During the 9 clock pulse, the device that recognizes its own address holds the data line low to acknowledge (Refer to Figure 23). The acknowledge bit is also used by both the master and the slave to acknowledge receipt of register addresses and data.

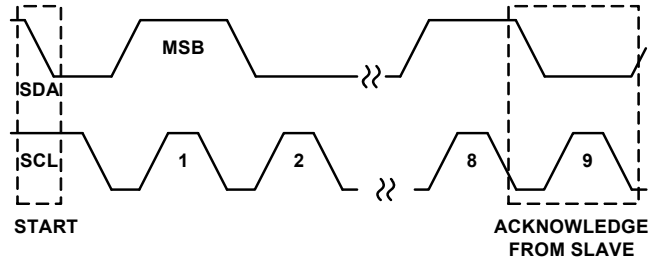

FIGURE 23. ACKNOWLEDGE ON THE SMBus

SMBus Transactions

All transactions start with a control byte sent from the SMBus master device. The control byte begins with a Start condition, followed by 7 bits of slave address (0001001 for the ISL9237) and the R/W bit. The R/W bit is 0 for a WRITE or 1 for a READ. If any slave device on the SMBus bus recognizes its address, it will acknowledge by pulling the serial data (SDA) line low for the last clock cycle in the control byte. If no slave exists at that address or it is not ready to communicate, the data line will be one, indicating a Not Acknowledge condition.

Once the control byte is sent and the ISL9237 acknowledges it, the second byte sent by the master must be a register address byte such as 0x14 for the ChargeCurrent register. The register address byte tells the ISL9237 which register the master will write or read. See Table 1 on page 17 for details of the registers. Once the ISL9237 receives a register address byte, it will respond with an acknowledge.

Byte Format

Every byte put on the SDA line must be 8 bits long and must be followed by an acknowledge bit. Data is transferred with the Most Significant Bit first (MSB) and the Least Significant Bit (LSB) last. The LO BYTE data is transferred before the HI BYTE data. For example, when writing 0x41A0, 0xA0 is written first and 0x41 is written second.

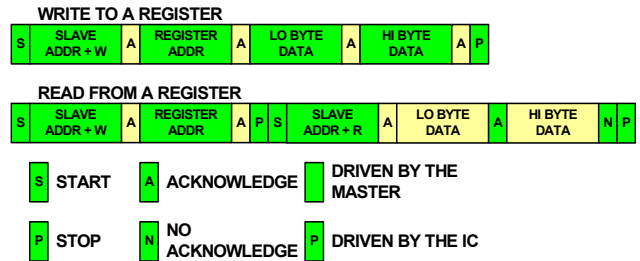

FIGURE 24. SMBus READ AND WRITE PROTOCOL

SMBus and I²C Compatibility

The ISL9237 SMBus minimum input logic high voltage is 2V, so it is compatible with an I²C with higher than 2V pull-up power supply.

The ISL9237 SMBus registers are 16 bits, so it is compatible with a 16-bit I²C or an 8-bit I²C with auto-increment capability.

ISL9237 SMBus Commands

The ISL9237 receives control inputs from the SMBus interface after Power-On Reset (POR). The serial interface complies with the System Management Bus Specification, which can be downloaded from www.smbus.org. The ISL9237 uses the SMBus Read-word and Write-word protocols (see [Figure 24 on page 16](#)) to communicate with the host system and a smart battery. The ISL9237 is an SMBus slave device and does not initiate communication on the bus. It responds to the 7-bit address 0b0001001₋:

Read address = 0b00010011 (0x13H) and

Write address = 0b00010010 (0x12H).

The data (SDA) and clock (SCL) pins have Schmitt-trigger inputs that can accommodate slow edges. Choose pull-up resistors for SDA and SCL to achieve rise times according to the SMBus specifications.

The illustration in this datasheet is based on current sensing resistors $R_{S1} = 20\text{m}\Omega$ and $R_{S2} = 10\text{m}\Omega$ unless otherwise specified.

TABLE 1. REGISTER SUMMARY

REGISTER NAMES	REGISTER ADDRESS	READ/WRITE	NUMBER OF BITS	DESCRIPTION	DEFAULT
ChargeCurrentLimit	0x14	R/W	11	[12:2] 11-bit, LSB size 4mA, maximum range 6080mA for 10m Ω R_{S2} .	0A
AdapterCurrentLimit1	0x3F	R/W	11	[12:2] 11-bit, LSB size 4mA, maximum range 6080mA for 20m Ω R_{S1} .	Set by PROG pin
AdapterCurrentLimit2	0x3B	R/W	11	[12:2] 11-bit, LSB size 4mA, maximum range 6080mA for 20m Ω R_{S1} .	1500mA
MaxSystemVoltage	0x15	R/W	11	[13:3] 11-bit, LSB size 8mV, maximum range 13.824V.	4.192V for 1-cell
					8.384V for 2-cell
					12.576V for 3-cell
MinSystemVoltage	0x3E	R/W	11	[13:3] 11-bit, LSB size 8mV, maximum range 13.824V.	2.688V for 1-cell
					5.376V for 2-cell
					8.064V for 3-cell
ACProchot#	0x47	R/W	6	[12:7] adapter current Prochot# threshold. LSB size 128mA, maximum 6.4A for 20m Ω R_{S1} .	3.072A
DCProchot#	0x48	R/W	6	[13:8] Battery discharging current Prochot# threshold. LSB size 256mA, maximum 12.8A for 10m Ω R_{S2} .	4.096A
T1 and T2	0x38	R/W	6	Configure two-level adapter current limit duration	0x000h
Control0	0x39	R/W	8	Configure various charger options	0x0000h
Control1	0x3C	R/W	16	Configure various charger options	0x0000h
Control2	0x3D	R/W	16	Configure various charger options	0x0000h
Information	0x3A	R	16	Indicate various charger status	0x0000h
OTGVoltage	0x49	R/W	6	[12:7] 6-bit, OTG mode output voltage reference. LSB size 128mV, maximum 5.376V and minimum 4.864V.	5.12V
OTGCurrent	0x4A	R/W	6	[12:7] 6-bit, OTG mode output current limit. LSB size 128mA, maximum 4.096A for 20m Ω R_{S1} .	512mA
ManufacturerID	0xFE	R	8	Manufacturers ID register - 0x49 - Read only	0x0049h
DeviceID	0xFF	R	8	Device ID register - 0x0A - Read only	0x000Ah

Setting Charging Current Limit

To set the charging current limit, write a 16-bit ChargeCurrentLimit command (0x14H or 0b00010100) using the Write-word protocol shown in [Figure 24 on page 16](#) and the data format shown in [Table 2](#) for a 10mΩ R_{S2} or [Table 3](#) for a 5mΩ R_{S2}.

The ISL9237 limits the charging current by limiting the CSOP-CSON voltage. By using the recommended current sense resistor values R_{S1} = 20mΩ and R_{S2} = 10mΩ, the register's LSB always translates to 1mA of charging current. The ChargeCurrentLimit register accepts any charging current command but only the valid register bits will be written to the register and the maximum value is clamped at 6080mA for R_{S2} = 10mΩ.

After POR, the ChargeCurrentLimit register is reset to 0x0000H. To set the battery charging current value, write a non-zero number to the ChargeCurrentLimit register. The ChargeCurrentLimit register can be read back to verify its content.

[Table 2](#) shows the conditions to enable fast charging according to the ChargeCurrentLimit register setting.

TABLE 2. ChargeCurrentLimit REGISTER 0x14H (11-BIT, 4mA STEP, 10mΩ SENSE RESISTOR, x36)

BIT	DESCRIPTION
<1:0>	Not used
<2>	0 = Add 0mA of charge current limit. 1 = Add 4mA of charge current limit.
<3>	0 = Add 0mA of charge current limit. 1 = Add 8mA of charge current limit.
<4>	0 = Add 0mA of charge current limit. 1 = Add 16mA of charge current limit.
<5>	0 = Add 0mA of charge current limit. 1 = Add 32mA of charge current limit.
<6>	0 = Add 0mA of charge current limit. 1 = Add 64mA of charge current limit.
<7>	0 = Add 0mA of charge current limit. 1 = Add 128mA of charge current limit.
<8>	0 = Add 0mA of charge current limit. 1 = Add 256mA of charge current limit.
<9>	0 = Add 0mA of charge current limit. 1 = Add 512mA of charge current limit.
<10>	0 = Add 0mA of charge current limit. 1 = Add 1024mA of charge current limit.
<11>	0 = Add 0mA of charge current limit. 1 = Add 2048mA of charge current limit.
<12>	0 = Add 0mA of charge current limit. 1 = Add 4096mA of charge current limit.
<13:15>	Not used
Maximum	<12:2> = 10111110000, 6080mA

TABLE 3. ChargeCurrentLimit REGISTER 0x14H (11-BIT, 8mA STEP, 5mΩ SENSE RESISTOR, x36)

BIT	DESCRIPTION
<1:0>	Not used
<2>	0 = Add 0mA of charge current limit. 1 = Add 8mA of charge current limit.
<3>	0 = Add 0mA of charge current limit. 1 = Add 16mA of charge current limit.
<4>	0 = Add 0mA of charge current limit. 1 = Add 32mA of charge current limit.
<5>	0 = Add 0mA of charge current limit. 1 = Add 64mA of charge current limit.
<6>	0 = Add 0mA of charge current limit. 1 = Add 128mA of charge current limit.
<7>	0 = Add 0mA of charge current limit. 1 = Add 256mA of charge current limit.
<8>	0 = Add 0mA of charge current limit. 1 = Add 512mA of charge current limit.
<9>	0 = Add 0mA of charge current limit. 1 = Add 1024mA of charge current limit.
<10>	0 = Add 0mA of charge current limit. 1 = Add 2048mA of charge current limit.
<11>	0 = Add 0mA of charge current limit. 1 = Add 4096mA of charge current limit.
<12>	0 = Add 0mA of charge current limit. 1 = Add 8192mA of charge current limit.
<13:15>	Not used
Maximum	<12:2> = 10111110000, 12160mA

Setting Adapter Current Limit

To set the adapter current limit, write a 16-bit AdapterCurrentLimit1 command (0x3FH or 0b00111111) and/or AdapterCurrentLimit2 command (0x3BH or 0b00111011) using the Write-word protocol shown in [Figure 24](#) and the data format shown in [Table 4](#) for a 20mΩ R_{S1} or [Table 5](#) for a 10mΩ R_{S1}.

The ISL9237 limits the adapter current by limiting the CSIP-CSIN voltage. By using the recommended current sense resistor values, the register's LSB always translates to 1mA of adapter current. Any adapter current limit command will be accepted but only the valid register bits will be written to the AdapterCurrentLimit1 and AdapterCurrentLimit2 registers, and the maximum value is clamped at 6080mA for R_{S1} = 20mΩ.

After adapter POR, the AdapterCurrentLimit1 register is reset to the value programmed through the PROG pin resistor. The AdapterCurrentLimit2 register is set to its default value of 1.5A or keep the value that is written to it previously if battery is present first. The AdapterCurrentLimit1 and AdapterCurrentLimit2 registers can be read back to verify their content.

To set a second level adapter current limit, write a 16-bit AdapterCurrentLimit2 (0x3BH or 0b00111011) command using the Write-word protocol shown in [Figure 24](#) and the data format as shown in [Table 4](#) for a 20mΩ R_{S1} or [Table 5](#) for a 10mΩ R_{S1}.

The AdapterCurrentLimit2 register has the same specification as the AdapterCurrentLimit1 register. Refer to [“Two-Level Adapter Current Limit” on page 30](#) for detailed operation.

TABLE 4. AdapterCurrentLimit1 REGISTER 0x3FH AND AdapterCurrentLimit2 REGISTER 0x3BH (11-BIT, 4mA STEP, 20mΩ SENSE RESISTOR, x16)

BIT	DESCRIPTION
<1:0>	Not used
<2>	0 = Add 0mA of adapter current limit. 1 = Add 4mA of adapter current limit.
<3>	0 = Add 0mA of adapter current limit. 1 = Add 8mA of adapter current limit.
<4>	0 = Add 0mA of adapter current limit. 1 = Add 16mA of adapter current limit.
<5>	0 = Add 0mA of adapter current limit. 1 = Add 32mA of adapter current limit.
<6>	0 = Add 0mA of adapter current limit. 1 = Add 64mA of adapter current limit.
<7>	0 = Add 0mA of adapter current limit. 1 = Add 128mA of adapter current limit.
<8>	0 = Add 0mA of adapter current limit. 1 = Add 256mA of adapter current limit.
<9>	0 = Add 0mA of adapter current limit. 1 = Add 512mA of adapter current limit.
<10>	0 = Add 0mA of adapter current limit. 1 = Add 1024mA of adapter current limit.
<11>	0 = Add 0mA of adapter current limit. 1 = Add 2048mA of adapter current limit.
<12>	0 = Add 0mA of adapter current limit. 1 = Add 4096mA of adapter current limit.
<13:15>	Not used
Maximum	<12:4> = 10111110000, 6080mA

TABLE 5. AdapterCurrentLimit1 REGISTER 0x3FH AND AdapterCurrentLimit2 REGISTER 0x3BH (11-BIT, 8mA STEP, 10mΩ SENSE RESISTOR, x16)

BIT	DESCRIPTION
<1:0>	Not used.
<2>	0 = Add 0mA of adapter current limit. 1 = Add 8mA of adapter current limit.
<3>	0 = Add 0mA of adapter current limit. 1 = Add 16mA of adapter current limit.
<4>	0 = Add 0mA of adapter current limit. 1 = Add 32mA of adapter current limit.
<5>	0 = Add 0mA of adapter current limit. 1 = Add 64mA of adapter current limit.
<6>	0 = Add 0mA of adapter current limit. 1 = Add 128mA of adapter current limit.
<7>	0 = Add 0mA of adapter current limit. 1 = Add 256mA of adapter current limit.

TABLE 5. AdapterCurrentLimit1 REGISTER 0x3FH AND AdapterCurrentLimit2 REGISTER 0x3BH (11-BIT, 8mA STEP, 10mΩ SENSE RESISTOR, x16) (Continued)

BIT	DESCRIPTION
<8>	0 = Add 0mA of adapter current limit. 1 = Add 512mA of adapter current limit.
<9>	0 = Add 0mA of adapter current limit. 1 = Add 1024mA of adapter current limit.
<10>	0 = Add 0mA of adapter current limit. 1 = Add 2048mA of adapter current limit.
<11>	0 = Add 0mA of adapter current limit. 1 = Add 4096mA of adapter current limit.
<12>	0 = Add 0mA of adapter current limit. 1 = Add 8192mA of adapter current limit.
<13:15>	Not used
Maximum	<12:4> = 10111110000, 12160mA

Setting Two-Level Adapter Current Limit Duration

For a two-level adapter current limit, write a 16-bit T1 and T2 command (0x38H or 0b00111000) using the Write-word protocol shown in [Figure 24](#) and the data format as shown in [Table 6](#) to set the AdapterCurrentLimit1 duration T1. Write a 16-bit T2 command (0x38H or 0b00111000) to set AdapterCurrentLimit2 duration T2. T1 and T2 register accepts any command, however, only the valid register bits will be written. Refer to [“Two-Level Adapter Current Limit” on page 30](#) for detailed operation.

TABLE 6. T1 AND T2 REGISTER 0x38H

BIT	DESCRIPTION
T1 <2:0>	000 = 10ms 001 = 20ms 010 = 15ms 011 = 5ms 100 = 1ms 101 = 0.5ms 110 = 0.1ms 111 = 0ms
T2 <10:8>	000 = 10μs (default) 001 = 100μs 010 = 500μs 011 = 1ms 100 = 300μs 101 = 750μs 110 = 2ms 111 = 10ms

Setting Maximum Charging Voltage or System Regulating Voltage

To set the maximum charging voltage or the system regulating voltage, write a 16-bit MaxSystemVoltage command (0x15H or 0b00010101) using the Write-word protocol shown in [Figure 24](#) and the data format as shown in [Table 7](#).

The MaxSystemVoltage register accepts any voltage command however, only the valid register bits will be written to the register and the maximum value is clamped at 13.824V.

The MaxSystemVoltage register sets the battery full charging voltage limit. The MaxSystemVoltage register setting also is the system bus voltage regulation point when battery is absent or battery is present, however, is not in charging mode. See ["System Voltage Regulation" on page 31](#) for details.

The VSYS pin is used to sense the battery voltage for maximum charging voltage regulation. VSYS pin is also the system bus voltage regulation sense point.

TABLE 7. MaxSystemVoltage REGISTER 0x15H (8mV STEP)

BIT	DESCRIPTION
<2:0>	Not used
<3>	0 = Add 0mV of charge voltage. 1 = Add 8mV of charge voltage.
<4>	0 = Add 0mV of charge voltage. 1 = Add 16mV of charge voltage.
<5>	0 = Add 0mV of charge voltage. 1 = Add 32mV of charge voltage.
<6>	0 = Add 0mV of charge voltage. 1 = Add 64mV of charge voltage.
<7>	0 = Add 0mV of charge voltage. 1 = Add 128mV of charge voltage.
<8>	0 = Add 0mV of charge voltage. 1 = Add 256mV of charge voltage.
<9>	0 = Add 0mV of charge voltage. 1 = Add 512mV of charge voltage.
<10>	0 = Add 0mV of charge voltage. 1 = Add 1024mV of charge voltage.
<11>	0 = Add 0mV of charge voltage. 1 = Add 2046mV of charge voltage.
<12>	0 = Add 0mV of charge voltage. 1 = Add 4096mV of charge voltage.
<13>	0 = Add 0mV of charge voltage. 1 = Add 8192mV of charge voltage.
<15:14>	Not used
Maximum	<13:3> = 11011000000, 13824mV

Setting Minimum System Voltage

To set the minimum system voltage, write a 16-bit MinSystemVoltage command (0x3EH or 0b00111110) using the Write-word protocol shown in [Figure 24](#) and the data format as shown in [Table 8](#).

The MinSystemVoltage register accepts any voltage command, however, only the valid register bits will be written to the register,

and the maximum value is clamped at 13.824V. The MinSystemVoltage register value should be set lower than the MaxSystemVoltage register value.

The MinSystemVoltage register sets the battery voltage threshold for entry and exit of the trickle charging mode and for entry and exit of the Learn mode. The VBAT pin is used to sense the battery voltage to compare with the MinSystemVoltage register setting. Refer to ["Trickle Charging" on page 31](#) and ["Battery Learn Mode" on page 29](#) for details.

The MinSystemVoltage register setting also is the system voltage regulation point when it is in trickle charging mode. The CSON pin is the system voltage regulation sense point in trickle charging mode. Refer to ["System Voltage Regulation" on page 31](#) for details.

TABLE 8. MinSystemVoltage REGISTER 0x3EH

BIT	DESCRIPTION
<2:0>	Not used
<3>	0 = Add 0mV of charge voltage. 1 = Add 8mV of charge voltage.
<4>	0 = Add 0mV of charge voltage. 1 = Add 16mV of charge voltage.
<5>	0 = Add 0mV of charge voltage. 1 = Add 32mV of charge voltage.
<6>	0 = Add 0mV of charge voltage. 1 = Add 64mV of charge voltage.
<7>	0 = Add 0mV of charge voltage. 1 = Add 128mV of charge voltage.
<8>	0 = Add 0mV of charge voltage. 1 = Add 256mV of charge voltage.
<9>	0 = Add 0mV of charge voltage. 1 = Add 512mV of charge voltage.
<10>	0 = Add 0mV of charge voltage. 1 = Add 1024mV of charge voltage.
<11>	0 = Add 0mV of charge voltage. 1 = Add 2046mV of charge voltage.
<12>	0 = Add 0mV of charge voltage. 1 = Add 4096mV of charge voltage.
<13>	0 = Add 0mV of charge voltage. 1 = Add 8192mV of charge voltage.
<15:14>	Not used
Maximum	<13:3> = 11011000000, 13824mV

Setting PROCHOT# Threshold for Adapter Overcurrent Condition

To set the PROCHOT# assertion threshold for adapter overcurrent condition, write a 16-bit ACProchot# command (0x47H or 0b01000111) using the Write-word protocol shown in [Figure 24](#) and the data format shown in [Table 9 on page 21](#). By using the recommended current sense resistor values, the register's LSB always translates to 1mA of adapter current. The ACProchot# register accepts any current command, however, only the valid register bits will be written to the register, and the maximum value is clamped at 6400mA for $R_{S1} = 20m\Omega$.

After POR, the ACProchot# register is reset to 0x0C00H. The ACProchot# register can be read back to verify its content.

If the adapter current exceeds the ACProchot# register setting, PROCHOT# signal will assert after the debounce time programmed by the Control2 register Bit<10:9> and latch on for a minimum time programmed by Control2 register Bit<8:6>.

TABLE 9. ACProchot# REGISTER 0x47H (20mΩ SENSING RESISTOR, 128mA STEP, x18 GAIN)

BIT	DESCRIPTION
<6:0>	Not used
<7>	0 = Add 0mA of ACProchot# threshold. 1 = Add 128mA of ACProchot# threshold.
<8>	0 = Add 0mA of ACProchot# threshold. 1 = Add 256mA of ACProchot# threshold.
<9>	0 = Add 0mA of ACProchot# threshold. 1 = Add 512mA of ACProchot# threshold.
<10>	0 = Add 0mA of ACProchot# threshold. 1 = Add 1024mA of ACProchot# threshold.
<11>	0 = Add 0mA of ACProchot# threshold. 1 = Add 2048mA of ACProchot# threshold.
<12>	0 = Add 0mA of ACProchot# threshold. 1 = Add 4096mA of ACProchot# threshold.
<15:13>	Not used
Maximum	<12:7> = 110010, 6400mA

Setting PROCHOT# Threshold for Battery Over Discharging Current Condition

To set the PROCHOT# signal assertion threshold for battery over discharging current condition, write a 16-bit DCProchot# command (0x48H or 0b01001000) using the Write-word protocol shown in [Figure 24](#) and the data format shown in [Table 10](#). By using the recommended current sense resistor values, the register's LSB always translates to 1mA of adapter current. The DCProchot# register accepts any current command, however, only the valid register bits will be written to the register and the maximum value is clamped at 12.8A for $R_{s2} = 10m\Omega$.

After POR, the DCProchot# register is reset to 0x1000H. The DCProchot# register can be read back to verify its content.

If the battery discharging current exceeds the DCProchot# register setting, the PROCHOT# signal will assert after the debounce time programmed by the Control2 register Bit<10:9> and latch on for a minimum time programmed by Control2 register Bit<8:6>.

In battery only and Low Power mode, the DCProchot# threshold is set by Control0 register Bit<4:3>.

In battery only mode, DCProchot# function works only when PSYS is enabled, since enabling PSYS will activate the internal comparator reference. The Information register Bit<15> indicates if the internal comparator reference is active or not. When adapter is present, the internal comparator reference is always active.

TABLE 10. DCPROCHOT# REGISTER 0x48H (10mΩ SENSING RESISTOR, 256mA STEP, x18 GAIN)

BIT	DESCRIPTION
<7:0>	Not used
<8>	0 = Add 0mA of DCProchot# threshold. 1 = Add 256mA of DCProchot# threshold.
<9>	0 = Add 0mA of DCProchot# threshold. 1 = Add 512mA of DCProchot# threshold.
<10>	0 = Add 0mA of DCProchot# threshold. 1 = Add 1024mA of DCProchot# threshold.
<11>	0 = Add 0mA of DCProchot# threshold. 1 = Add 2048mA of DCProchot# threshold.
<12>	0 = Add 0mA of DCProchot# threshold. 1 = Add 4096mA of DCProchot# threshold.
<13>	0 = Add 0mA of DCProchot# threshold. 1 = Add 8192mA of DCProchot# threshold.
<15:14>	Not used
Maximum	<13:8> = 110010, 12800mA

Setting PROCHOT# Debounce Time and Duration Time

Control2 register Bit<10:9> configures the PROCHOT# signal debounce time before its assertion for ACProchot# and DCProchot#. The low system voltage Prochot# has a fixed debounce time of 10μs.

Control2 register Bit<8:6> configures the minimum duration of Prochot# signal once asserted.

Control Registers

Control0, Control1 and Control2 registers configure the operation of the ISL9237. To change certain functions or options after POR, write an 8-bit control command to Control0 register (0x39H or 0b00111001) or a 16-bit control command to Control1 register (0x3CH or 0b00111100) or Control2 register (0x3DH or 0b00111101) using the Write-word protocol shown in [Figure 24](#) and the data format shown in [Tables 11](#), [12](#) and [13](#), respectively.

TABLE 11. CONTROL0 REGISTER 0x39H

BIT	BIT NAME	DESCRIPTION																				
<15:8>		Not used																				
<7>	SMBus Timeout	The ISL9237 includes a timer to insure the SMBus master is active and to prevent overcharging the battery. If the adapter is present and if the ISL9237 does not receive a write to the MaxChargeVoltage or ChargeCurrentLimit register within 175s, ISL9237 will terminate charging. If a timeout occurs, writing the MaxChargeVoltage or ChargeCurrentLimit register will re-enable charging. 0 = Enable the SMBus timeout function (default). 1 = Disable the SMBus timeout function.																				
<6:5>	High-Side FET Short Detection Threshold	Bit<6:5> configures the high-side FET short detection PHASE node voltage threshold during low-side FET turning on. 00 = 400mV (default) 01 = 500mV 10 = 600mV 11 = 800mV																				
<4:3>	DCProchot# Threshold in Battery Only Low Power Mode	Bit<4:3> only configures the battery discharging current DCProchot# threshold in battery only Low Power mode indicated by the Information register 0x3A Bit<15>. If PSYS is enabled, battery discharge current DCProchot# threshold is set by the DCProchot# register 0x48 setting.																				
		<table border="1"> <thead> <tr> <th>BIT<4:3></th> <th>R_{S2} = 10mΩ (A)</th> <th>R_{S2} = 20mΩ (A)</th> <th>R_{S2} = 5mΩ (A)</th> </tr> </thead> <tbody> <tr> <td>00</td> <td>12 (Default)</td> <td>6</td> <td>24</td> </tr> <tr> <td>01</td> <td>10</td> <td>5</td> <td>20</td> </tr> <tr> <td>10</td> <td>8</td> <td>4</td> <td>16</td> </tr> <tr> <td>11</td> <td>6</td> <td>3</td> <td>12</td> </tr> </tbody> </table>	BIT<4:3>	R _{S2} = 10mΩ (A)	R _{S2} = 20mΩ (A)	R _{S2} = 5mΩ (A)	00	12 (Default)	6	24	01	10	5	20	10	8	4	16	11	6	3	12
		BIT<4:3>	R _{S2} = 10mΩ (A)	R _{S2} = 20mΩ (A)	R _{S2} = 5mΩ (A)																	
		00	12 (Default)	6	24																	
		01	10	5	20																	
10	8	4	16																			
11	6	3	12																			
00	12 (Default)	6	24																			
01	10	5	20																			
10	8	4	16																			
11	6	3	12																			
<2>	Input Voltage Regulation Loop	Bit<2> disables or enables the input voltage regulation loop. 0 = Enable (default) 1 = Disable																				
<1:0>	Input Voltage Regulation Reference	Bit<1:0> configures the input voltage loop regulation reference. 00 = 3.9V (default) 01 = 4.2V 10 = 4.5V 11 = 4.8V																				

TABLE 12. CONTROL1 REGISTER 0x3CH

BIT	BIT NAME	DESCRIPTION
<15:14>	General Purpose Comparator Assertion Debounce Time	Bit<15:14> configures the general purpose comparator assertion debounce time. 00 = 2μs (default) 01 = 12μs 10 = 2ms 11 = 5s
13	Exit Learn Mode Option	Bit<12> provides the option to exit Learn mode when battery voltage is lower than MinSystemVoltage register setting. 0 = Stay in Learn mode even if V _{BAT} < MinSystemVoltage register setting (default) 1 = Exit Learn mode if V _{BAT} < MinSystemVoltage register setting
12	Learn Mode	Bit<13> enables or disables the Battery Learn mode. 0 = Disable (default) 1 = Enable To enter Learn mode, BATGONE pin needs to be low, i.e., battery must be present.
11	OTG Function	Bit<11> enables or disables OTG function. 0 = Disable (default) 1 = Enable
10	Audio Filter	Bit<10> enables or disables the audio filter function. 0 = Disable (default) 1 = Enable

TABLE 12. CONTROL1 REGISTER 0x3CH

BIT	BIT NAME	DESCRIPTION
<9:7>	Switching Frequency	Bit<9:7> configures the switching frequency and overrides the switching frequency set by PROG pin. 000 = Switching frequency set by PROG pin (default) 001 = 913kHz 010 = 839kHz 011 = 777kHz 100 = 723kHz 101 = 676kHz 110 = 635kHz 111 = 599kHz To keep the switching frequency set by PROG pin resistor, leave Bit<9:7> as it is or write code 000, which sets the same frequency as the PROG pin resistor.
6	Turbo	Bit<6> enables or disables Turbo mode. When the turbo function is enabled, BGATE FET turns on in Turbo mode. Refer to Table 19 on page 30 for BGATE ON/OFF truth table. 0 = Enable (default) 1 = Disable
5	AMON/BMON Function	Bit<5> enables or disables the current monitor function AMON and BMON. 0 = Enable AMON/BMON (default) 1 = Disable AMON/BMON Bit<5> is only valid in battery only mode. When adapter is present, AMON/BMON is automatically enabled and Bit<5> becomes invalid.
4	AMON or BMON	Bit<4> selects AMON or BMON as the output of AMON/BMON pin. 0 = AMON (default) 1 = BMON
3	PSYS	Bit<3> enables or disable system power monitor PSYS function. 0 = Disable (default) 1 = Enable
2	VSYS	Bit<2> enables or disables the buck-boost charger switching VSYS output. When disabled, ISL9237 stops switching and forces BGATE FET on. 0 = Enable (default) 1 = Disable
<1:0>	Low_VSYS_Prochot# Reference	Bit<1:0> configures the Low_VSYS_Prochot# assertion threshold. 00 = 6.0V (default) 01 = 6.3V 10 = 6.6V 11 = 6.9V For 1-cell configuration, the Low_VSYS_Prochot# assertion threshold is fixed 2.4V.

TABLE 13. CONTROL2 REGISTER 0x3DH

BIT	BIT NAME	DESCRIPTION
<15:14>	Trickle Charging Current	Bit<15:14> configures the charging current in trickle charging mode. 00 = 256mA (default) 01 = 128mA 10 = 64mA 11 = 512mA
13	OTG Function Enable Debounce Time	Bit<13> configures the OTG function debounce time from when ISL9237 receives the OTG enable command. 0 = 1.3s (default) 1 = 150ms
12	Two-Level Adapter Current Limit Function	Bit<12> enables or disables the two-level adapter current limit function. 0 = Disable (default) 1 = Enable

TABLE 13. CONTROL2 REGISTER 0x3DH (Continued)

BIT	BIT NAME	DESCRIPTION
11	Adapter Insertion to ASGATE Turning On Debounce	Bit<11> configures the debounce time from adapter insertion to ASGATE turning on. 0 = 1.3s (default) 1 = 150ms After VDD POR, for the first time adapter is plugged in, the ASGATE turn-on delay is always 150ms, regardless of the Bit<11> setting. This bit only sets the ASGATE turn-on delay after ASGATE turns off at least one time when VDD is above the POR value and Bit<11> default is 0 for 1.3s.
<10:9>	Prochot# Debounce	Bit<10:9> configures the Prochot# debounce time before its assertion for ACProchot# and DCProchot#. 00: 10µs (default) 01: 100µs 10: 500µs 11: 1ms The Low_VSYS_Prochot# has fixed 10µs debounce time.
<8:6>	Prochot# Duration	Bit<8:6> configures the minimum duration of Prochot# signal once asserted. 000 = 10ms (default) 001 = 20ms 010 = 15ms 011 = 5ms 100 = 1ms 101 = 500µs 110 = 100µs 111 = 0s
5	ASGATE in OTG Mode	Bit<5> turns on or off the ASGATE FET in OTG mode. 0 = Turn ON ASGATE in OTG mode (default) 1 = Turn OFF ASGATE in OTG mode
4	CMIN Reference	Bit<4> configures the general purpose comparator reference voltage. 0 = 1.2V (default) 1 = 2V
3	General Purpose Comparator	Bit<3> enables or disabled the general purpose comparator. 0 = Enable (default) 1 = Disable
2	CMOUT Polarity	Bit<2> configures the general purpose comparator output polarity once asserted. The comparator reference voltage is connected at the inverting input node. 0 = CMOUT is high when CMIN is higher than reference (default) 1 = CMOUT is low when CMIN is higher than reference
1	WOCP Function	Bit<1> enables or disables the WOC (Way Overcurrent) fault protection function. 0 = Enable WOCP (default) 1 = Disable WOCP
0	PSYS Gain	Bit<0> configures the system power monitor PSYS output gain. 0 = 1.44µA/W (default) 1 = 0.36µA/W

OTGVoltage Register

To set the OTG mode output regulation voltage, write a 16-bit OTGVoltage command (0x49H or 0b01001001) using the Write-word protocol shown in [Figure 24 on page 16](#) and the data format as shown in [Table 14](#).

The OTGVoltage register accepts any voltage command, however, only the valid register bits will be written to the register, and the maximum value is clamped at 5.376V and the minimum value is clamped at 4.864V.

TABLE 14. OTGVOLTAGE REGISTER 0x49H

BIT	DESCRIPTION
<6:0>	Not used
<7>	0 = Add 0mV of OTG voltage 1 = Add 128mV of OTG voltage
<8>	0 = Add 0mV of OTG voltage 1 = Add 256mV of OTG voltage
<9>	0 = Add 0mV of OTG voltage 1 = Add 512mV of OTG voltage
<10>	0 = Add 0mV of OTG voltage 1 = Add 1024mV of OTG voltage

TABLE 14. OTGVOLTAGE REGISTER 0x49H (Continued)

BIT	DESCRIPTION
<11>	0 = Add 0mV of OTG voltage 1 = Add 2048mV of OTG voltage
<12>	0 = Add 0mV of OTG voltage 1 = Add 4096mV of OTG voltage
<15:13>	Not used
Range	<12:7> = 101010, maximum 5.376V <12:7> = 100110, minimum 4.864V

OTGCurrent Register

To set the OTG mode output current limit threshold, write a 16-bit OTGVoltage command (0x4AH or 0b01001010) using the Write-word protocol shown in [Figure 24 on page 16](#) and the data format as shown in [Table 15](#).

The OTGCurrent register accepts any current command, however, only the valid register bits will be written to the register, and the maximum value is clamped at 4096mA for $R_{s1} = 20m\Omega$.

TABLE 15. OTGCURRENT 0x4AH

BIT	DESCRIPTION
<6:0>	Not used
<7>	0 = Add 0mA of OTG current 1 = Add 128mA of OTG current
<8>	0 = Add 0mA of OTG current 1 = Add 256mA of OTG current
<9>	0 = Add 0mV of OTG current 1 = Add 512mA of OTG current
<10>	0 = Add 0mV of OTG current 1 = Add 1024mA of OTG current
<11>	0 = Add 0mV of OTG current 1 = Add 2048mA of OTG current
<12>	0 = Add 0mV of OTG current 1 = Add 4096mA of OTG current
<15:13>	Not used
Maximum	<12:7> = 100000, 4096mA

Information Register

The Information Register contains SMBus readable information about manufacturing and operating modes. [Table 16](#) identifies the bit locations of the information available.

TABLE 16. INFORMATION REGISTER 0x3AH

BIT	DESCRIPTION
<3:0>	Bit<3:0> indicates the configuration set by PROG pin resistor. In battery only mode, Bit<3:0> shows the PROG pin programmed configuration only after PROG pin resistor is read by enabling PSYS. <3:0> = Cell number, Default f_{SW} , default AdapterCurrentLimit1 register setting. 0000 = 3-cell, 1MHz, 1.5A, 0001 = 3-cell, 1MHz, 0.476A, 0010 = 3-cell, 723kHz, 1.5A 0011 = 3-cell, 723kHz, 0.476A 0100 = 3-cell, 723kHz, 0.1A 0101 = 2-cell, 1MHz, 1.5A 0110 = 2-cell, 1MHz, 0.476A 0111 = 2-cell, 723kHz, 1.5A 1000 = 2-cell, 723kHz, 0.476A 1001 = 2-cell, 723kHz, 0.1A 1010 = 1-cell, 1MHz, 0.1A 1011 = 1-cell, 1MHz, 1.5A 1100 = 1-cell, 1MHz, 0.476A 1101 = 1-cell, 723kHz, 1.5A 1110 = 1-cell, 723kHz, 0.476A 1111 = 1-cell, 723kHz, 0.1A
<4>	Bit<4> indicates if the trickle charging mode is active or not. 0 = Trickle charging mode is not active 1 = Trickle charging mode is active
<6:5>	Bit<6:5> indicates the ISL9237 operation mode. 00 = Buck mode 01 = Boost mode 10 = Buck-boost mode 11 = OTG mode
<9:7>	Bit<9:7> indicates the ISL9237 state machine status 000 = OFF 001 = BATTERY 010 = ADAPTER 011 = ACOK 100 = VSYS 101 = CHARGE 110 = ENOTG 111 = OTG
<10>	Bit<10> indicates if the Low_VSYS_Prochot# is tripped or not. 0 = Low_VSYS Prochot# is not tripped 1 = Low_VSYS Prochot# is tripped
<11>	Bit<11> indicates if the battery discharging Prochot# signal DCProchot# is tripped or not. 0 = DCProchot# is not tripped 1 = DCProchot# is tripped

TABLE 16. INFORMATION REGISTER 0x3AH (Continued)

BIT	DESCRIPTION
<12>	Bit<12> indicates if the adapter current Prochot# signal ACProchot# is tripped or not. 0 = ACProchot# is not tripped 1 = ACProchot# is tripped
<14:13>	Bit<14:13> indicates the active control loop. 00 = MaxSystemVoltage control loop is active 01 = Charging current loop is active 10 = Adapter current limit loop is active 11 = Input voltage loop is active
<15>	Bit<15> indicates if the internal reference circuit is active or not. Bit<15> = 0 indicates that ISL9237 is in Low Power mode. 0 = Reference is not active 1 = Reference is active

Application Information

R3™ Modulator

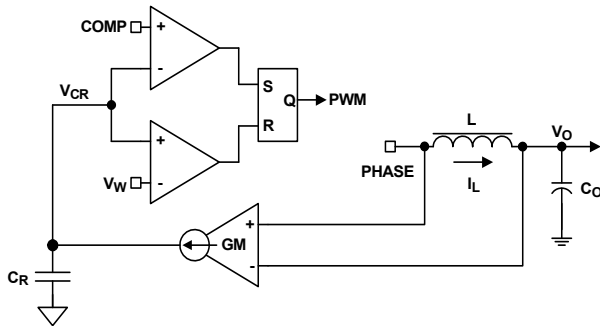

FIGURE 25. R3™ MODULATOR

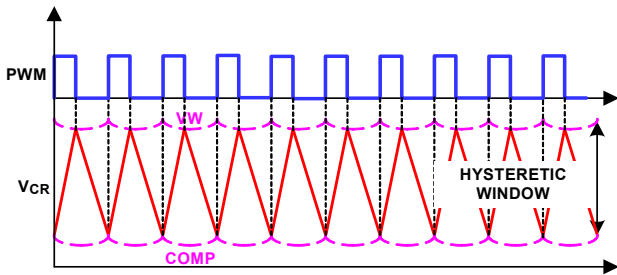

FIGURE 26. R3™ MODULATOR OPERATION PRINCIPLES IN STEADY STATE

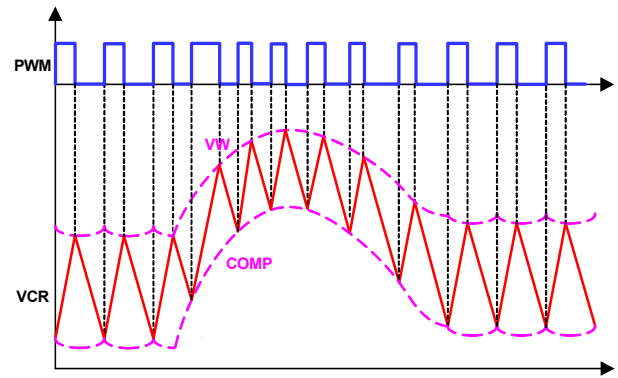

FIGURE 27. R3™ MODULATOR OPERATION PRINCIPLES IN DYNAMIC RESPONSE

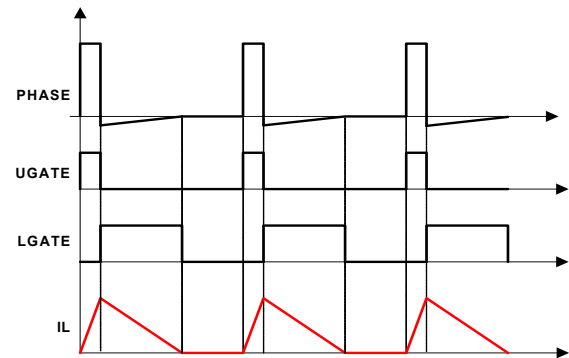

FIGURE 28. DIODE EMULATION

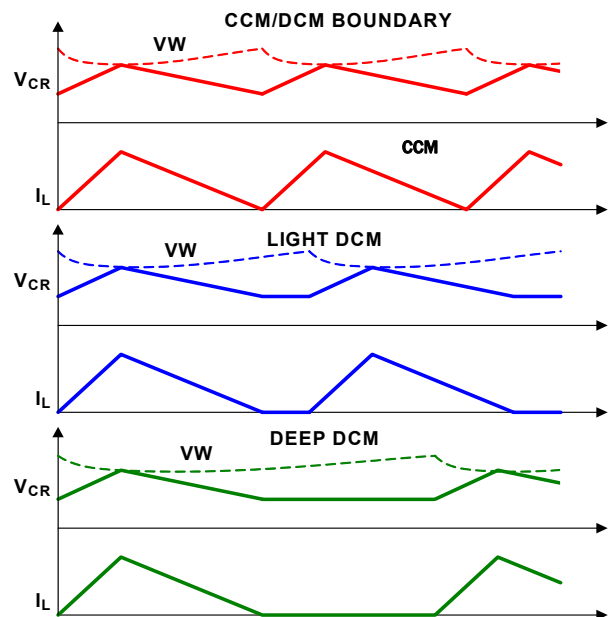

FIGURE 29. PERIOD STRETCHING

The ISL9237 uses the Intersil patented R3™ (Robust Ripple Regulator) modulation scheme. The R3™ modulator combines the best features of fixed frequency PWM and hysteretic PWM while eliminating many of their shortcomings. [Figure 25](#)

conceptually shows the R3™ modulator circuit and [Figure 26](#) shows the operation principles in steady state.

There is a fixed voltage window between VW and COMP. This voltage window is called the VW window in the following discussion. The modulator charges the ripple capacitor C_R with a current source equal to $g_m(V_{IN} - V_O)$ during PWM on-time and discharges the ripple capacitor C_R with a current source equal to $g_m V_O$, during PWM off-time, where g_m is a gain factor. The C_r voltage V_{CR} therefore emulates the inductor current waveform. The modulator turns off the PWM pulse when V_{CR} reaches VW and turns on the PWM pulse when it reaches COMP.

Since the modulator works with V_{CR} , which is a large amplitude and noise free synthesized signal, it achieves lower phase jitter than conventional hysteretic mode modulator.

[Figure 27](#) shows the operation principles during dynamic response. The COMP voltage rises during dynamic response, turning on PWM pulses earlier and more frequently temporarily, which allows for higher control loop bandwidth than conventional fixed frequency PWM modulator at the same steady state switching frequency.

The R3™ modulator can operate in Diode Emulation (DE) mode to increase light-load efficiency. In DE mode the low-side MOSFET conducts when the current is flowing from source-to-drain and does not allow reverse current, emulating a diode. As shown in [Figure 28](#), when LGATE is on, the low-side MOSFET carries current, creating negative voltage on the phase node due to the voltage drop across the ON-resistance. The IC monitors the current by monitoring the phase node voltage. It turns off LGATE when the phase node voltage reaches zero to prevent the inductor current from reversing the direction and creating unnecessary power loss.

If the load current is light enough, as [Figure 28](#) shows, the inductor current will reach and stay at zero before the next phase node pulse and the regulator is in Discontinuous Conduction Mode (DCM). If the load current is heavy enough, the inductor current will never reach 0A and the regulator is in CCM although the controller is in DE mode.

[Figure 29](#) shows the operation principle in diode emulation mode at light load. The load gets incrementally lighter in the three cases from top to bottom. The PWM on-time is determined by the VW window size, therefore is the same, making the inductor current triangle the same in the three cases. The R3™ modulator clamps the ripple capacitor voltage V_{CR} in DE mode to make it mimic the inductor current. It takes the COMP voltage longer to hit V_{CR} , naturally stretching the switching period. The inductor current triangles move further apart from each other, such that the inductor current average value is equal to the load current. The reduced switching frequency helps increase light-load efficiency.

ISL9237 Buck-Boost Charger with USB OTG

The ISL9237 buck-boost charger drives an external N-channel MOSFET bridge comprised of two transistor pairs as shown in [Figure 30](#). The first pair, Q1 and Q2, is a buck arrangement with the transistor center tap connected to an inductor “input” as is the case with a buck converter. The second transistor pair, Q3 and Q4, is a boost arrangement with the transistor center tap

connected to the same inductor’s “output” as is the case with a boost converter. This arrangement supports bucking from a voltage input higher than the battery and also boosting from a voltage input lower than the battery.

In Buck mode, Q1 and Q2 turn on and off alternatively, while Q3 remains off and Q4 remains on.

In Boost mode, Q3 and Q4 turn on and off alternatively, while Q1 remains on and Q2 remains off.

In Buck-boost mode, Q1 and Q3 is turned on and off at the same time and alternatively with Q2 and Q4, which turned off and on at the same time.

In OTG mode, Q3 and Q4 turn on and off alternatively as a buck regulator with V_{BAT} as the input, while Q1 remains on and Q2 remains off with the CSIP pin as the output sensing point.

TABLE 17. OPERATION MODE

MODE	Q1	Q2	Q3	Q4
Buck	Control FET	Sync. FET	OFF	ON
Boost	ON	OFF	Control FET	Sync. FET
Buck-Boost	Control FET	Sync. FET	Control FET	Sync. FET
OTG	ON	OFF	Sync. FET	Control FET

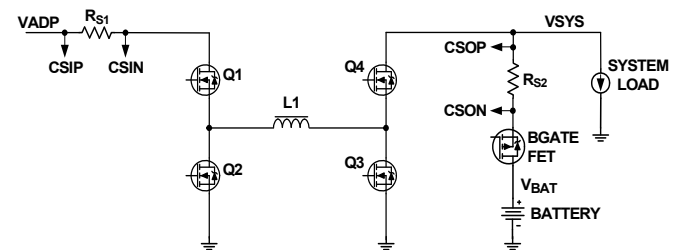

FIGURE 30. BUCK-BOOST CHARGER TOPOLOGY

The ISL9237 optimizes the operation mode transition algorithm by considering the input and output voltage ratio and the load condition. When adapter voltage V_{ADP} is rising and is higher than 94% of the system bus voltage V_{SYS} , ISL9237 will transit from Boost mode to Buck-boost mode; if V_{ADP} is higher than 120% of V_{SYS} , ISL9237 will forcibly transit from Buck-boost mode to Buck mode at any circumstance. At heavier load, the mode transition point changes accordingly to accommodate the duty cycle change due to the power loss on the charger circuit.

When the adapter voltage V_{ADP} is falling and is lower than 106% of the system bus voltage V_{SYS} , ISL9237 will transit from Buck mode to Buck-boost mode; if V_{ADP} is lower than 80% of V_{SYS} , ISL9237 will transit from Buck-boost mode to Boost mode.

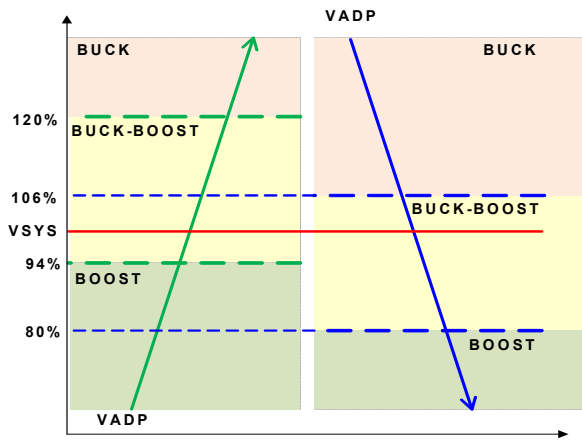

FIGURE 31. OPERATION MODE

When the OTG function is enabled with SMBus command and OTGEN pin, and if battery voltage V_{BAT} is higher than 5.8V, ISL9237 operates in the reverse Buck mode, Q4, Q3 and L1 consists of the reverse buck regulator, Q1 is turned on and Q2 is turned off. For reverse buck, there is one digital bit to control ASGATE. OTG mode is not available for 1-cell battery systems.

The ISL9237 connects the system voltage rail to either the output of the buck-boost switcher or the battery. In Turbo event, the ISL9237 will turn on the BGATE FET to discharge the battery so the battery works with the adapter together to supply the system power.

Soft-Start

The ISL9237 includes a low power LDO with nominal 4V output, which input is OR-ed from pins VBAT and ADP. The ISL9237 also includes a high power LDO with nominal 5V output, which input is from the DCIN pin connected to the adapter and the system bus through an external OR-ing diode circuit. Both LDO outputs are tied to the VDD pin to provide the bias power and gate drive power for ISL9237. VDDP pin is the ISL9237 gate drive power supply input. Use an R-C filter to generate the VDDP pin voltage from the VDD pin voltage.

When $VDD > 2.7V$, the ISL9237 digital block is activated and the SMBus register is ready to communicate with the master controller.

When $VADP > 3.2V$, after 1.3s or 150ms debounce time set by Control2 register Bit<11> (after VDD POR, for the first time adapter plugged in, the ASGATE turn on delay is always 150ms), ASGATE starts turning on with 10µA sink current. During the 1.3s or 150ms debounce time, ISL9237 uses ‘Intersil’s patent pending technique to check if the input bus is short or not; if CSIP < 2V or ACIN < 0.8V, ASGATE will not turn on. The soft-start scheme will carefully bias up the input capacitors and protect the back-to-back ASGATE FETs against potential damage caused by the inrush current.

Use a voltage divider from the adapter voltage to set the ACIN pin voltage. The ISL9237 monitors the ACIN pin voltage to determine the presence of the adapter. Once $VDD > 3.8V$, the ACIN pin voltage exceeds 0.8V and ASGATE is fully turned on, the ISL9237 will allow the external circuit to pull up the ACOK pin. Once ACOK is asserted, ISL9237 will start switching.

ACOK is an open-drain output pin indicating the presence of the adapter and readiness of the adapter to supply power to the system bus. The ISL9237 actively pulls ACOK low in the absence of the adapter.

Before ASGATE turns ON, the ISL9237 will source 10µA of current out of the PROG pin and read the pin voltage to determine the PROG resistor value. The PROG resistor programs the configurations of the ISL9237.

In battery only mode, ISL9237 enters Low Power mode if only battery is present. VDD is 4V from the low power LDO to minimize the power consumption. VDD becomes 5V once it exits the Low Power mode such as when PSYS is enabled.

Programming Charger Option

The resistor from the PROG pin to GND programs the configuration of the ISL9237 for the default number of battery cells in series, the default switching frequency and the default AdapterCurrentLimit1 register value. AdapterCurrentLimit2 register default value is 1.5A. Table 18 shows the programming options.

TABLE 18. PROG PIN PROGRAMMING OPTIONS

PROG-PIN RESISTOR (kΩ)			BATTERY CELL NUMBER	DEFAULT SWITCHING FREQUENCY	DEFAULT AdapterCurrentLimit1 Register (A)
MIN	VALUE 1%	MAX			
	0		1-cell	733kHz	0.1
16.6	16.9	17.2			0.476
31.1	31.6	32.1			1.5
43.5	44.2	44.9		1MHz	0.476
58.1	59	59.9			1.5
72.1	73.2	74.3	2-cell	733kHz	0.1
85.3	86.6	87.9			0.476
101	102	103			1.5
113.9	115	116.2		1MHz	0.476
128.7	130	131.3			1.5
141.6	143	144.4			0.1
156.4	158	159.6			0.476
172.3	174	175.7	733kHz	1.5	
185.1	187	188.9		1MHz	0.476
201	203 (Note 8)	205			1.5
218.8	221	223.2	3-cell	733kHz	0.476
				1MHz	1.5

NOTE:

- 8. 203kΩ is not standard resistor; use two resistors in series or in parallel to get the closest value.

ISL9237 will use the default number of cells in series as Table 18 shows and sets the default MaxSystemVoltage register value and default MinSystemVoltage register value accordingly.

The switching frequency can be changed through SMBus Control1 register Bit<9:7> after POR. Refer to the SMBus Control1 register programming table for detailed description.

Before ASGATE turns on, ISL9237 will source 10 μ A current out of the PROG pin and read the PROG pin voltage to determine the resistor value. However, application environmental noise may pollute the PROG pin voltage and cause incorrect reading. If noise is a concern, it is recommended to connect a capacitor from the PROG pin to GND to provide filtering. The resistor and the capacitor RC time constant should be less than 40 μ s so the PROG pin voltage can rise to steady state before the ISL9237 reads it.

If ISL9237 is powered up from battery, it will not read the PROG resistor unless PSYS is enabled through SMBus Control1 register Bit<3>. In battery only mode, whenever PSYS is enabled, ISL9237 will read the PROG pin resistor and reset the configuration to the default.

Whenever the adapter is plugged in, ISL9237 will reset the AdapterCurrentLimit1 register to the default by reading PROG pin resistor if it is not read before or by loading the previous reading result.

If PSYS is not enabled, ISL9237 will reset MaxSystemVoltage register and MinSystemVoltage register to their default values according to the PROG pin cell number setting. If PSYS is enabled, ISL9237 will keep the values in these two registers.

By default, the adapter current sensing resistor, R_{S1} , is 20m Ω and the battery current sensing resistor, R_{S2} , is 10m Ω . Using this $R_{S1} = 20\text{m}\Omega$ and $R_{S2} = 10\text{m}\Omega$ option would result in 1mA/LSB correlation in the SMBus current commands.

If R_{S1} and R_{S2} values are different from this $R_{S1} = 20\text{m}\Omega$ and $R_{S2} = 10\text{m}\Omega$ option, the SMBus command needs to be scaled accordingly to obtain the correct current. Smaller current sense resistor values reduce the power loss while larger current sense resistor values give better accuracy.

If different current sensing resistors are used, the $R_{S1}:R_{S2}$ ratio should be kept as 2:1, then PSYS output can be scaled accordingly to reflect the total system power correctly.

The illustration in this datasheet is based on current sensing resistors $R_{S1} = 20\text{m}\Omega$ and $R_{S2} = 10\text{m}\Omega$ unless specified otherwise.

DE Operation

In DE mode of operation, the ISL9237 employs a phase comparator to monitor the PHASE node voltage during the low-side switching FET on-time in order to detect the inductor current zero crossing. The phase comparator needs a minimum on-time of the low-side switching FET for it to recognize inductor current zero crossing. If the low-side switching FET on-time is too short for the phase comparator to successfully recognize the inductor zero crossing, the ISL9237 may lose diode emulation ability. To prevent such a scenario, the ISL9237 employs a minimum low-side switching FET on-time. When the intended low-side switching FET on-time is shorter than the minimum value, the ISL9237 stretches the switching period in order to keep the low-side switching FET on-time at the minimum value, which causes the CCM switching frequency to drop below the set point.

Power Source Selection

The ISL9237 automatically selects the adapter and/or the battery as the source for system power.

The BGATE pin drives a P-channel MOSFET gate that connects/disconnects the battery from the system and the switcher.

The ASGATE pin drives a pair of back-to-back common source PFETs to connect/disconnect the adapter from the system and the battery. Use of the ASGATE pin is optional.

When battery voltage V_{BAT} is higher than 2.4V and adapter voltage V_{ADP} is less than 3.2V, ISL9237 operates in battery only mode. During the battery only mode, ISL9237 turns on the BGATE FET to connect the battery to the system. In battery only mode, the ISL9237 consumes very low power, less than 20 μ A during this mode. The battery discharging current monitor BMON can be turned on during this mode to monitor the battery discharging current. If the battery voltage V_{BAT} is higher than 5.8V, the system power monitor PSYS function also can be turned on during this mode to monitor system power.

In battery only mode, the USB OTG function can be enabled, see ["USB OTG \(On-the-Go\)" on page 31](#) for details.

When adapter voltage, V_{ADP} , is more than 3.2V, ISL9237 turns on ASGATE. If V_{DD} is higher than 3.8V, ISL9237 enters in the forward buck, forward boost or forward Buck-boost mode depending upon the adapter and system voltage, V_{SYS} , duty cycle ratio. The system bus voltage is regulated at the voltage set on the MaxSystemVoltage register. If the charge current register is programmed (non-zero), ISL9237 charges the battery either in trickle charging mode or fast charging mode, as long as BATGONE is low.

Battery Learn Mode

The ISL9237 supports battery Learn mode. The ISL9237 enters Battery Learn mode when it receives SMBus Control command.

This mode of operation is used when it is desired to supply the system power from the battery even when the adapter is plugged in, such as calibration of the battery fuel gauge, hence the name "Battery Learn mode".

Upon entering Battery Learn mode the ISL9237 will turn on the BGATE FET when the system bus voltage decays to the battery voltage in order to avoid inrush current from the system bus to the battery.

In Battery Learn mode, the ISL9237 turns on BGATE, keeps ASGATE on, however, turns off the buck-boost switcher regardless of whether the adapter is present or not.

There are three ways of exiting Battery Learn mode:

1. Receive Battery Learn mode exit command through SMBus.
2. Battery voltage is less than MinSystemVoltage register setting (according to Control1 register Bit<12> setting).
3. BATGONE pin voltage goes from logic LOW to HIGH.

In all these cases, the ISL9237 resumes switching immediately to supply power to the system bus from the adapter in order to prevent system voltage collapse.

Turbo Mode Support

Turbo mode refers to the scenario when the system draws more power than the adapter's power rating.

If the adapter current reaches the AdapterCurrentLimit1 register set value (or AdapterCurrentLimit2 register set value, if two-level adapter current limit function is enabled), or the adapter input voltage drops to the input voltage regulation reference set by Control0 register 0x39H Bit<1:0>, the ISL9237 will limit the input power by regulating the adapter current at AdapterCurrentLimit1/2 register set value, or by regulating the adapter voltage at the input voltage regulation reference point.

In Turbo mode, the system bus voltage VSYS will drop automatically or the charging current will drop automatically to limit the adapter input power. If the VSYS pin voltage is 150mV lower than the VBAT pin voltage, BGATE FET will turn on, such that the battery supplies the rest of the power required by the system.

If the ISL9237 detects 150mA charging current or if the battery discharging current is less than 300mA for longer than 20ms, it will turn off BGATE to exit Turbo mode. Refer to [Table 19](#) for BGATE control logic.

TABLE 19. BGATE ON/OFF TRUTH TABLE

TURBO (CONTROL BIT)	CHARGE CURRENT REGISTER	BGATE ON/OFF	
0 = ENABLE 1 = DISABLE	0 = ZERO 1 = NONZERO	SYSTEM LOAD NOT IN TURBO MODE RANGE	SYSTEM LOAD IN TURBO MODE RANGE
0	0	OFF	ON
0	1	ON for fast charge; Trickle charge is enabled	ON
1	0	OFF	OFF
1	1	ON for fast charge; Trickle charge is enabled	ON

Two-Level Adapter Current Limit

In a real system, Turbo event usually does not last very long. It is often no longer than milliseconds, a time length during which the adapter can supply current higher than its DC rating. The ISL9237 employs two-level adapter current limit in order to fully take advantage of adapter's surge capability and minimize the power drawn from the battery.

[Figure 32](#) shows the two SMBus programmable adapter current limit levels, AdapterCurrentLimit1 and AdapterCurrentLimit2, as well as the durations t1 and t2. The two-level adapter current limit function is initiated when the adapter current is less than 100mA lower than the AdapterCurrentLimit1 register setting and it starts at AdapterCurrentLimit2 for t2 duration and then changes to AdapterCurrentLimit1 for t1 duration before repeating the pattern. These parameters can set adapter current limit with an envelope that allows the adapter to temporarily

output surge current without requiring the charger to enter Turbo mode. Such operation maximizes battery life.

AdapterCurrentLimit1 register value can be higher or lower than AdapterCurrentLimit2 value.

The two-level adapter current limit function can be enabled and disabled through SMBus Control2 register Bit<12>. When the two-level adapter current limit function is disabled, only AdapterCurrentLimit1 value is used as the adapter current limit and AdapterCurrentLimit2 value is ignored.

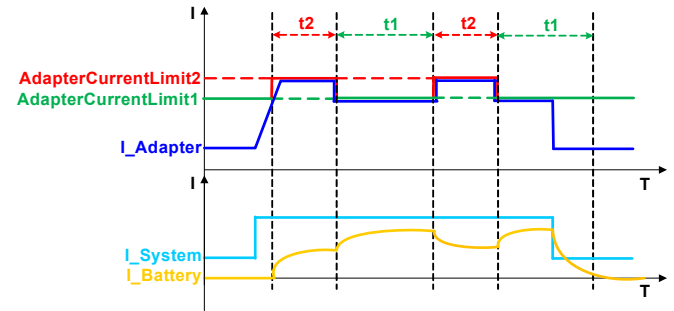

FIGURE 32. TWO LEVEL ADAPTER CURRENT LIMIT

Current Monitor

The ISL9237 provides an adapter current monitor or a battery discharging current monitor through the AMON/BMON pin. The AMON output voltage is 18x the (CSIP-CSIN) voltage and the BMON output voltage is 18x the (CSON-CSOP) voltage.

AMON and BMON function can be enabled or disabled through SMBus Control1 register Bit<5> and Bit<4> as [Table 12 on page 22](#) shows.

PSYS Monitor

The ISL9237 PSYS pin provides a measure of the instantaneous power consumption of the entire platform. The PSYS pin outputs a current source described by [Equation 1](#).

$$I_{PSYS} = K_{PSYS} \times (V_{ADP} \times I_{ADP} + V_{BAT} \times I_{BAT}) \quad (EQ. 1)$$

K_{PSYS} is based on current sensing resistor R_{S1} = 20mΩ and R_{S2} = 10mΩ. V_{ADP} is the adapter voltage in volts, I_{ADP} is the adapter current in amperes, V_{BAT} is the battery voltage and I_{BAT} is the battery discharging current. When the battery is discharging, I_{BAT} is a positive value; when the battery is being charged, I_{BAT} is a negative value. The battery voltage V_{BAT} is detected through the CSON pin to maximize the power monitor accuracy in NVDC configuration trickle charge mode.

The R_{S1} to R_{S2} ratio must be 2:1 for a valid power calculation to occur. If the resistance values are higher (or lower) than the suggested values above, K_{PSYS} will be proportionally higher (or lower). As an example, if R_{S1} = 10mΩ and R_{S2} = 5mΩ, then the output current will be half the value for the same power. If the PSYS information is not needed then any R_{S1}:R_{S2} ratio is acceptable.

The PSYS information includes the power loss of the charger circuit and the actual power delivered to the system. Resistor

R_{PSYS} connected between the PSYS pin and GND converts the PSYS information from current to voltage.

PSYS accuracy limits and a typical accuracy scan are shown in [Figure 33 on page 31](#).

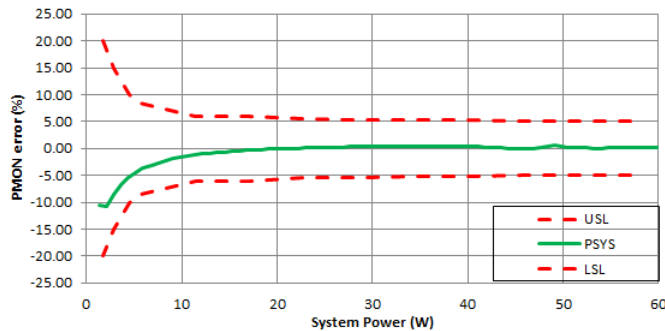

FIGURE 33. PSYS ACCURACY AND LIMITS

The PSYS function can be enabled or disabled through SMBus Control1 register Bit<3> as shown in [Table 12 on page 22](#).

In battery only mode, the PSYS function cannot work if the battery voltage is less than 5.8V.

Trickle Charging

The ISL9237 supports trickle charging to an overly discharged battery. It can activate the trickle charging function when the battery voltage is lower than MinSystemVoltage setting. V_{BAT} pin is the battery voltage sense point for trickle charge mode.

To enable trickle charging, set ChargeCurrent register to a non-zero value. To disable trickle charging, set ChargeCurrent register to 0. Refer to [Table 19](#) for trickle charging control logic.

The trickle charging current can be programmed to be 256mA, 128mA or 64mA through SMBus Control2 register Bit<15:14> in [Table 13 on page 23](#).

In trickle charging mode, the ISL9237 regulates the trickle charging current through the buck-boost switcher. Another independent control loop controls the BGATE FET such that the system voltage is maintained at the voltage set in the MinSystemVoltage register. The VSYS pin is the system voltage sensing point in trickle charging mode.

Once the battery voltage is charged the MinSystemVoltage register value, the ISL9237 enters fast charging mode by limiting the charging current at the ChargeCurrentLimit register setting.

System Voltage Regulation

If the battery is absent, or if a battery is present, however, BGATE is turned off, the ISL9237 will regulate the system bus voltage at the MaxSystemVoltage register setting. The VSYS pin is used to sense the system bus voltage.

Charger Timeout

The ISL9237 includes a timer to insure the SMBus master is active and to prevent overcharging the battery. The ISL9237 will terminate charging by turning off BGATE FET if the charger has not received a write command to the MaxSystemVoltage or ChargeCurrent register within 175s. When the charging is terminated by the timeout, the ChargeCurrent register will retain

its value instead of resetting to zero. If a timeout occurs, MaxSystemVoltage or ChargeCurrent register must be written to re-enable charging.

The ISL9237 allows users to disable the charger timeout function through SMBus Control0 register Bit<7> as [Table 11 on page 22](#) shows.

USB OTG (On-the-Go)

When the OTG function is enabled with SMBus command and OTGEN pin, and if battery voltage V_{BAT} is higher than 5.8V, ISL9237 operates in the reverse Buck mode, Q4, Q3 and L1 consists of the reverse buck regulator and Q1 remains on and Q2 remains off.

Once ISL9237 receives the command to enable the OTG function, it will start switching after the 1.3s or 150ms debounce time set by Control2 register Bit<13>. Once the OTG output voltage is between 4.2V and 6V, OTG power-good OTGPG will assert to High. Moreover, Control2 register Bit<5> can be used to turn ASGATE FET off to cut off the OTG output.

Before OTG mode starts switching, the CSIP pin voltage needs to drop below the OTG output overvoltage protection threshold of 6V first.

The default OTG output voltage is 5.12V. The OTGVoltage register 0x49H can be used to configure the OTG output voltage.

The default OTG output current is limited at 512mA through R_{S1}. The OTGCurrent register 0x4AH can be used to adjust the OTG output current limit.

ISL9237 includes the OTG output undervoltage and overvoltage protection functions. The UVP threshold is 4.2V and the OVP threshold is 6V.

Once UV is detected, ISL9237 will stop switching and turn off ASGATE and deassert OTGPG. Once OTG output increases above 4.5V, after 1.3s or 150ms debounce time set by Control2 register Bit<13>, it will resume switching.

Once OV is detected, ISL9237 will stop switching and deassert OTGPG. It will resume switching after 100μs once OTG voltage drops below 5.7V.

BATGONE needs to be low to enable OTG mode. OTG mode is not available for 1-cell battery systems.

Stand-Alone Comparator

The ISL9237 includes a general purpose stand-alone comparator. OTGEN/CMIN pin is the comparator input. The internal comparator reference is connected to the inverting input of the comparator and can be configured as 1.2V or 2V through SMBus Control2 register Bit<4>. The comparator output is the OTGPG/CMOUT pin and the output polarity when the comparator is tripped can be configured through SMBus register bit.

When Control2 register Bit<2> = 0 for normal comparator output polarity, if CMIN > Reference then CMOUT = High; if CMIN < Reference then CMOUT = Low.

When Control2 register Bit<2> = 1 for inversed comparator output polarity, if CMIN > Reference then CMOUT = Low; if CMIN < Reference then CMOUT = High.

In battery only mode, the stand-alone comparator is disabled unless PSYS is enabled through SMBus Control1 register Bit<3> to enable the internal reference, which is indicated through Information register Bit<15>.

[Table 20](#) shows the OTG mode and the stand-alone comparator truth table.

TABLE 20. OTG AND COMPARATOR TRUTH TABLE

CONTROL1 REGISTER 0x3C	CONTROL2 REGISTER 0x3D	PIN-20	PIN-26	DESCRIPTION
BIT<11> OTG FUNCTION ENABLE/DISABLE	BIT<3> COMPARATOR ENABLE/DISABLE	OTGEN/CMIN	OTGPG/CMOUT	
0	0	Comparator input pin CMIN	Comparator output pin CMOUT	OTG function is disabled. Comparator is enabled.
0	1	X	X	Both OTG function and comparator are disabled.
1	0	Comparator input pin CMIN	Comparator output pin CMOUT	Both OTG function and comparator are enabled. OTG function is enabled when $V_{BAT} > 5.8V$ and Control1 register Bit<11> = 1 without OTG power-good pin indication. While the Information register 0x3A Bit<6:5> = 11 indicates it is in OTG mode.
1	1	OTG enable input pin OTGEN	OTG power-good indication pin OTGPG	Comparator is disabled. OTG function is enabled when $V_{BAT} > 5.8V$ and ENOTG pin = High and Control1 register Bit<11> = 1

Adapter Overvoltage Protection

If the ADP pin voltage exceeds 23.4V for more than 10 μ s, the ISL9237 will consider an adapter overvoltage condition has occurred. It will turn off the ASGATE MOSFETs to isolate the adapter from the system, deassert the ACOK signal by pulling it low and stop switching. BGATE will turn on for the battery to support the system load. Once ADP voltage drops below 23.04V from more than 100 μ s, it will start to turn on ASGATE and start switching.

System Overvoltage Protection

The ISL9237 provides system rail overvoltage protection. If the system voltage V_{SY} is 600mV higher than MaxSystemVoltage register set value, it will declare the system overvoltage and stop switching. It will resume switching without the 1.3s or 150ms debounce once V_{SY} drops 300mV below the system overvoltage threshold.

Way Overcurrent Protection (WOCP)

In the case that the system bus is shorted, either a MOSFET short or an inductor short, the input current could be high. ISL9237 includes input overcurrent protection to turn off the ASGATE and stop switching.

The ISL9237 provides adapter current and battery discharging current WOCP (Way Overcurrent Protection) function against the MOSFET short, system bus short and inductor short scenarios. ISL9237 monitors the CSIP-CSIN voltage and CSON-CSOP voltage, compares them with the WOCP threshold 12A for adapter current and 16A for battery discharge current.

When the WOC comparator is tripped, ISL9237 counts one time within each 20 μ s. Whenever ISL9237 counts WOC to 7 times in 656ms, it turns off ASGATE, deasserts ACOK and stops switching immediately. After the 1.3s or 150ms debounce time set by Control2 register Bit<11>, it goes through the start-up sequence to retry.

The WOCP function can be disabled through Control2 register Bit<1>.

Over-Temperature Protection

The ISL9237 turns off the internal LDO for self protection when the junction temperature exceeds +140°C. The internal LDO stays off until the junction temperature falls below +120°C.

The ISL9237 stops switching after declaring over-temperature protection.

Once the temperature falls below +120°C, and after a 100 μ s delay, the ISL9237 will enable the internal LDO and the ISL9237 will resume operation.

Switching Power MOSFET Gate Capacitance

The ISL9237 includes an internal 5V LDO output at V_{DD} pin, which can be used to provide the switching MOSFET gate driver power through V_{DDP} pin with an R-C filter. The 5V LDO output overcurrent protection threshold is 70mA nominal. When selecting the switching power MOSFET, the MOSFET gate capacitance should be considered carefully to avoid overloading the 5V LDO, specially in Buck-boost mode when four MOSFETs switching at the same time. For one MOSFET, the gate drive current can be estimated by [Equation 2](#):

$$I_{\text{driver}} = Q_g \cdot f_{\text{SW}} \quad (\text{Eq. 2})$$

Where:

- Q_g is the total gate charge, which can be found in the MOSFET datasheet
- f_{SW} is switching frequency

Adapter Input Filter

The adapter cable parasitic inductance and capacitance could cause some voltage ringing or an overshoot spike at the adapter connector node when the adapter is hot plugged in. This voltage spike could damage the ASGATE MOSFET or the ISL9237 pins connecting to the adapter connector node. One low cost solution is to add an RC snubber circuit at the adapter connector node to clamp the voltage spike as shown in [Figure 34](#). A practical value of the RC snubber is 2.2 Ω to 2.2 μ F while the appropriate values and power rating should be carefully characterized based on the actual design. Meanwhile, it is not recommended to add a pure capacitor at the adapter connector node, which can cause an even bigger voltage spike due to the adapter cable or the adapter current path parasitic inductance.

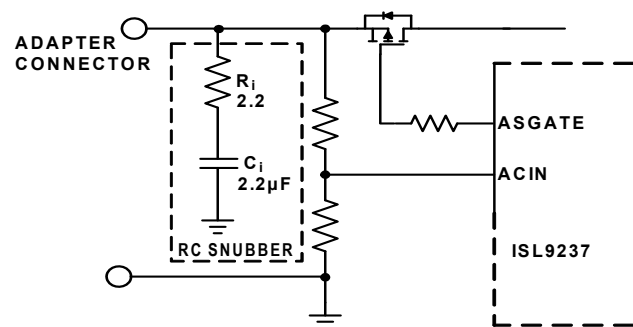

FIGURE 34. ADAPTER INPUT RC SNUBBER CIRCUIT

General Application Information

This design guide is intended to provide a high-level explanation of the steps necessary to design a single-phase power converter. It is assumed that the reader is familiar with many of the basic skills and techniques referenced in the following section. In addition to this guide, Intersil provides complete reference designs that include schematics, bill of materials and example board layouts.

Select the LC Output Filter

The duty cycle of an ideal buck converter in CCM is a function of the input and the output voltage. This relationship is written by [Equation 3](#):

$$D = \frac{V_{OUT}}{V_{IN}} \quad (\text{EQ. 3})$$

The output inductor peak-to-peak ripple current is written by [Equation 4](#):

$$I_{P-P} = \frac{V_{OUT} \cdot (1-D)}{f_{SW} \cdot L} \quad (\text{EQ. 4})$$

A typical step-down DC/DC converter will have an I_{P-P} of 20% to 40% of the maximum DC output load current for a practical design. The value of I_{P-P} is selected based upon several criteria such as MOSFET switching loss, inductor core loss and the resistive loss of the inductor winding.

The DC copper loss of the inductor can be estimated by [Equation 5](#):

$$P_{COPPER} = I_{LOAD}^2 \cdot DCR \quad (\text{EQ. 5})$$

Where I_{LOAD} is the converter output DC current.

The copper loss can be significant so attention has to be given to the DCR selection. Another factor to consider when choosing the inductor is its saturation characteristics at elevated temperatures. A saturated inductor could cause destruction of circuit components.

A DC/DC buck regulator must have output capacitance C_O into which ripple current I_{P-P} can flow. Current I_{P-P} develops a corresponding ripple voltage V_{P-P} across C_O , which is the sum of the voltage drop across the capacitor ESR and of the voltage change stemming from charge moved in and out of the capacitor. These two voltages are written by [Equations 6](#) and [7](#):

$$\Delta V_{ESR} = I_{P-P} \cdot ESR \quad (\text{EQ. 6})$$

$$\Delta V_C = \frac{I_{P-P}}{8 \cdot C_O \cdot f_{SW}} \quad (\text{EQ. 7})$$

If the output of the converter has to support a load with high pulsating current, several capacitors will need to be paralleled to reduce the total ESR until the required V_{P-P} is achieved. The inductance of the capacitor can cause a brief voltage dip if the load transient has an extremely high slew rate. Low inductance capacitors should be considered in this scenario. A capacitor dissipates heat as a function of RMS current and frequency. Be sure that I_{P-P} is shared by a sufficient quantity of paralleled capacitors so that they operate below the maximum rated RMS current at f_{SW} . Take into account that the rated value of a

capacitor can fade as much as 50% as the DC voltage across it increases.

Select the Input Capacitor

The important parameters for the input capacitance are the voltage rating and the RMS current rating. For reliable operation, select capacitors with voltage and current ratings above the maximum input voltage and capable of supplying the RMS current required by the switching circuit. Their voltage rating should be at least 1.25x greater than the maximum input voltage, while a voltage rating of 1.5x is a preferred rating.

[Figure 35](#) is a graph of the input capacitor RMS ripple current, normalized relative to output load current, as a function of duty cycle and is adjusted for converter efficiency. The normalized RMS ripple current calculation is written as [Equation 8](#):

$$I_{C_{IN}(RMS,NORMALIZED)} = \frac{I_{MAX} \cdot \sqrt{D \cdot (1-D) + \frac{D \cdot k^2}{12}}}{I_{MAX}} \quad (\text{EQ. 8})$$

Where:

- I_{MAX} is the maximum continuous I_{LOAD} of the converter
- k is a multiplier (0 to 1) corresponding to the inductor peak-to-peak ripple amplitude expressed as a ratio of I_{MAX} (0 to 1)
- D is the duty cycle that is adjusted to take into account the efficiency of the converter, which is written as [Equation 9](#):

$$D = \frac{V_{OUT}}{V_{IN} \cdot EFF} \quad (\text{EQ. 9})$$

In addition to the capacitance, some low ESL ceramic capacitance is recommended to decouple between the drain of the high-side MOSFET and the source of the low-side MOSFET.

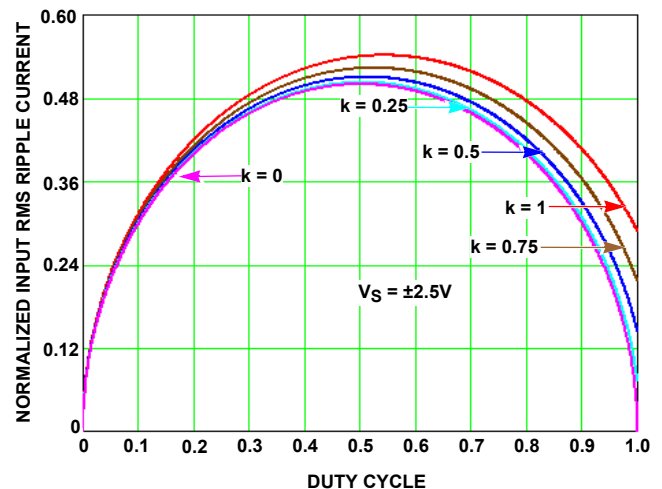

FIGURE 35. NORMALIZED RMS INPUT CURRENT AT EFF = 1

Select the Switching Power MOSFET

Typically, a MOSFET cannot tolerate even brief excursions beyond their maximum drain-to-source voltage rating. The MOSFETs used in the power stage of the converter should have a maximum VDS rating that exceeds the sum of the upper voltage tolerance of the input power source and the voltage spike that occurs when the MOSFET switches off.

There are several power MOSFETs readily available that are optimized for DC/DC converter applications. The preferred high-side MOSFET emphasizes low gate charge so that the device spends the least amount of time dissipating power in the linear region. Unlike the low-side MOSFET which has the drain-to-source voltage clamped by its body diode during turn off, the high-side MOSFET turns off with a VDS of approximately $V_{IN} - V_{OUT}$, plus the spike across it. The preferred low-side MOSFET emphasizes low $r_{DS(ON)}$ when fully saturated to minimize conduction loss. It should be noted that this is an optimal configuration of MOSFET selection for low duty cycle applications ($D < 50\%$). For higher output, low input voltage solutions, a more balanced MOSFET selection for high- and low-side devices may be warranted.

For the low-side (LS) MOSFET, the power loss can be assumed to be conductive only and is written as [Equation 10](#):

$$P_{CON_LS} \approx I_{LOAD}^2 \cdot r_{DS(ON)_LS} \cdot (1 - D) \quad (\text{EQ. 10})$$

For the high-side (HS) MOSFET, conduction loss is written by [Equation 11](#):

$$P_{CON_HS} = I_{LOAD}^2 \cdot r_{DS(ON)_HS} \cdot D \quad (\text{EQ. 11})$$

For the high-side MOSFET, the switching loss is written as [Equation 12](#):

$$P_{SW_HS} = \frac{V_{IN} \cdot I_{VALLEY} \cdot t_{SWON} \cdot f_{SW}}{2} + \frac{V_{IN} \cdot I_{PEAK} \cdot t_{SWOFF} \cdot f_{SW}}{2} \quad (\text{EQ. 12})$$

Where:

- I_{VALLEY} is the difference of the DC component of the inductor current minus 1/2 of the inductor ripple current.
- I_{PEAK} is the sum of the DC component of the inductor current plus 1/2 of the inductor ripple current.
- $t_{SW(ON)}$ is the time required to drive the device into saturation.
- $t_{SW(OFF)}$ is the time required to drive the device into cut-off.

Select the Bootstrap Capacitor

The selection of the bootstrap capacitor is written by [Equation 13](#):

$$C_{BOOT} = \frac{Q_g}{\Delta V_{BOOT}} \quad (\text{EQ. 13})$$

Where:

- Q_g is the total gate charge required to turn on the high-side MOSFET.
- ΔV_{BOOT} is the maximum allowed voltage decay across the boot capacitor each time the high-side MOSFET is switched on.

As an example, suppose the high-side MOSFET has a total gate charge Q_g of 25nC at $V_{GS} = 5V$ and a ΔV_{BOOT} of 200mV. The calculated bootstrap capacitance is 0.125 μ F; for a comfortable margin, select a capacitor that is double the calculated capacitance. In this example, 0.22 μ F will suffice. Use an X7R or X5R ceramic capacitor.

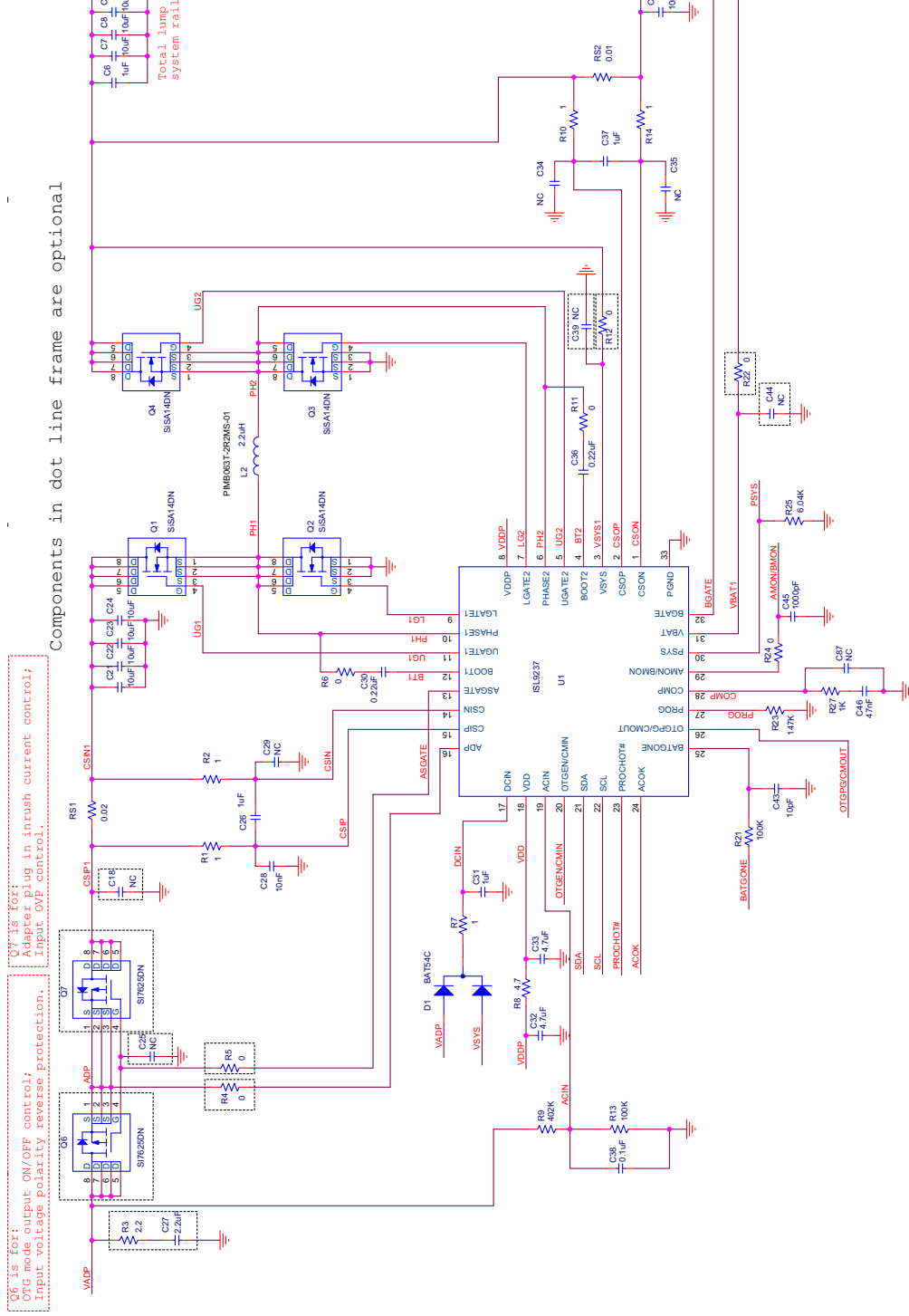

Components in dot line frame are optional

Q7 is for: output OV/OPP control; Input polarity reverse protection. Inrush current control. Input OVP control.

Q8 is for: output OV/OPP control; Input polarity reverse protection. Inrush current control. Input OVP control.

FIGURE 38. ISL9237 REFERENCE DESIGN

Layout Guidelines

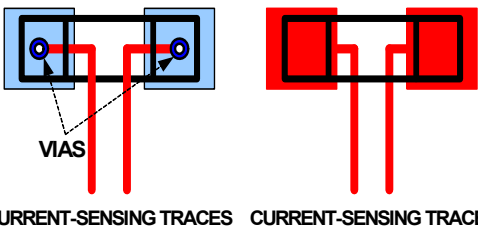
PIN NUMBER	PIN NAME	LAYOUT GUIDELINES
BOTTOM PAD 33	GND	Connect this ground pad to the ground plane through low impedance path. Recommend use of at least 5 vias to connect to ground planes in PCB to ensure there is sufficient thermal dissipation directly under the IC.
1	CSON	<p>Run two dedicated traces with decent width in parallel (close to each other to minimize the loop area) from the two terminals of the battery current sensing resistor to the IC. Place the differential mode and common-mode RC filter components in general proximity of the controller.</p> <p>Route the current sensing traces through vias to connect the center of the pads; or route the traces into the pads from the inside of the current sensing resistor. The following drawings show the two preferred ways of routing current sensing traces.</p>  <p style="text-align: center;">CURRENT-SENSING TRACES CURRENT-SENSING TRACES</p>
2	CSOP	
3	VSYS	Signal pin. Provides feedback for the system bus voltage. Place the optional RC filter in general proximity of the controller. Run a dedicated trace from system bus to the pin and do not route near the switching traces. Do not share the same trace with the signal routing to the DCIN pin OR diodes.
4	BOOT2	Switching pin. Place the bootstrap capacitor in general proximity of the controller. Use decent wide trace. Avoid any sensitive analog signal trace from crossing over or getting close.
5	UGATE2	Run these two traces in parallel fashion with decent width. Avoid any sensitive analog signal trace from crossing over or getting close. Recommend routing PHASE2 trace to high-side MOSFET source pin instead of general copper.
6	PHASE2	<p>The IC should be placed close to the switching MOSFET's gate terminals and keep the gate drive signal traces short for a clean MOSFET drive. The IC can be placed on the opposite side of the switching MOSFETs.</p> <p>Place the output capacitors as close as possible to the switching high-side MOSFET drain and the low-side MOSFET source; and use shortest PCB trace connection. Place these capacitors on the same PCB layer with the MOSFETs instead of on different layers and using vias to make the connection.</p> <p>Place the inductor terminal to the switching high-side MOSFET drain and low-side MOSFET source terminal as close as possible. Minimize this phase node area to lower the electrical and magnetic field radiation, however, make this phase node area big enough to carry the current. Place the inductor and the switching MOSFETs on the same layer of the PCB.</p>
7	LGATE2	Switching pin. Run LGATE2 trace in parallel with UGATE2 and PHASE2 traces on the same PCB layer. Use decent width. Avoid any sensitive analog signal trace from crossing over or getting close.
8	VDDP	Place the decoupling capacitor in general proximity of the controller. Run the trace connecting to VDD pin with decent width.
9	LGATE1	Switching pin. Run LGATE1 trace in parallel with UGATE1 and PHASE1 traces on the same PCB layer. Use decent width. Avoid any sensitive analog signal trace from crossing over or getting close.
10	PHASE1	Run these two traces in parallel fashion with decent width. Avoid any sensitive analog signal trace from crossing over or getting close. Recommend routing PHASE1 trace to high-side MOSFET source pin instead of general copper.
11	UGATE1	<p>The IC should be placed close to the switching MOSFET's gate terminals and keep the gate drive signal traces short for a clean MOSFET drive. The IC can be placed on the opposite side of the switching MOSFETs.</p> <p>Place the input capacitors as close as possible to the switching high-side MOSFET drain and the low-side MOSFET source; and use shortest PCB trace connection. Place these capacitors on the same PCB layer with the MOSFETs instead of on different layers and using vias to make the connection.</p> <p>Place the inductor terminal to the switching high-side MOSFET drain and low-side MOSFET source terminal as close as possible. Minimize this phase node area to lower the electrical and magnetic field radiation, however, make this phase node area big enough to carry the current. Place the inductor and the switching MOSFETs on the same layer of the PCB.</p>

Layout Guidelines (Continued)

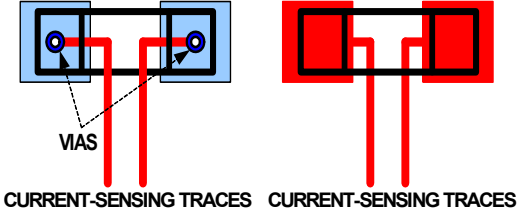
PIN NUMBER	PIN NAME	LAYOUT GUIDELINES
12	BOOT1	Switching pin. Place the bootstrap capacitor in general proximity of the controller. Use decent wide trace. Avoid any sensitive analog signal trace from crossing over or getting close.
13	ASGATE	Run this trace with decent width in parallel fashion with the ADP pin trace.
14	CSIN	Run two dedicated traces with decent width in parallel (close to each other to minimize the loop area) from the two terminals of the adapter current sensing resistor to the IC. Place the differential mode and common-mode RC filter components in general proximity of the controller.
15	CSIP	<p>Route the current sensing traces through vias to connect the center of the pads; or route the traces into the pads from the inside of the current sensing resistor. The following drawings show the two preferred ways of routing current sensing traces.</p>  <p style="text-align: center;">CURRENT-SENSING TRACES CURRENT-SENSING TRACES</p>
16	ADP	Run this trace with decent width in parallel fashion with the ASGATE pin trace.
17	DCIN	Place the OR diodes and the RC filter in general proximity of the controller. Run the VADP trace and VSYS trace to the OR diodes with decent width.
18	VDD	Place the RC filter connecting with VDDP pin in general proximity of the controller. Run the trace connecting to VDDP pin with decent width.
19	ACIN	Place the voltage divider resistors and the optional decoupling capacitor in general proximity of the controller.
20	OTGEN/CMIN	No special consideration.
21	SDA	Digital pins. No special consideration. Run SDA and SCL traces in parallel.
22	SCL	
23	PROCHOT#	Digital pin, open-drain output. No special consideration.
24	ACOK	
25	BATGONE	Digital pin. Place the 100kΩ resistor series in the BATGONE signal trace and the optional decoupling capacitor in general proximity of the controller.
26	OTGPG/CMOUT	Digital pin, open-drain output. No special consideration.
27	PROG	Signal pin. Place the PROG programming resistor in general proximity of the controller.
28	COMP	Place the compensation components in general proximity of the controller. Avoid any switching signal from crossing over or getting close.
29	AMON/BMON	No special consideration. Place the optional RC filter in general proximity of the controller.
30	PSYS	Signal pin, current source output. No special consideration.
31	VBAT	Place the optional RC filter in general proximity of the controller. Run a dedicated trace from the battery positive connection point to the IC.
32	BGATE	Use decent width trace from the IC to the BGATE MOSFET gate. Place the capacitor from BGATE to ground close to the MOSFET.

Revision History

The revision history provided is for informational purposes only and is believed to be accurate, however, not warranted. Please go to the web to make sure that you have the latest revision.

DATE	REVISION	CHANGE
Nov 29, 2017	FN7823.5	Added Way Overcurrent Protection (WOCP) function to datasheet.
October 4, 2017	FN7823.4	Applied new header/footer and formatting. Updated Related Literature Removed Way Overcurrent Protection (WOCP) feature from datasheet. Made Bit 1 on page 24 "Not used".
July 7, 2016	FN8723.3	Removed confidential information to make the datasheet publicly available on the web.
June 7, 2016	FN8723.2	Added Related Literature section. Updated the Ordering Information table by adding the Evaluation board part number. Fixed typo on Figure 2 on page 5. Updated "Power Source Selection" on page 29. Updated "Stand-Alone Comparator" on page 31.
May 12, 2016	FN8723.1	Updated Note 1 by adding "-T7A" option. Removed Evaluation Board from ordering information table. -Table 13 on page 23 updated Bit 11 from "Bit<11> configures the debounce time from ACOK assertion to switching" to "Bit<11> configures the debounce time from adapter insertion to ASGATE turning on" and changed the Bit name from "Adapter Insertion to Switching Debounce" to "Adapter Insertion to ASGATE Turning ON Debounce". -Table 18 on page 28 added Min and Max column to the table and updated Typ 1% values. Changed the note from "207kΩ is not standard resistor" to "203kΩ is not standard resistor".
February 10, 2016	FN8723.0	Initial Release

About Intersil

Intersil Corporation is a leading provider of innovative power management and precision analog solutions. The company's products address some of the largest markets within the industrial and infrastructure, mobile computing and high-end consumer markets.

For the most updated datasheet, application notes, related documentation and related parts, please see the respective product information page found at www.intersil.com.

You may report errors or suggestions for improving this datasheet by visiting www.intersil.com/ask.

For a listing of definitions and abbreviations of common terms used in our documents, visit: www.intersil.com/glossary.

Reliability reports are also available from our website at www.intersil.com/support.

© Copyright Intersil Americas LLC 2016-2017. All Rights Reserved.

All trademarks and registered trademarks are the property of their respective owners.

For additional products, see www.intersil.com/en/products.html

Intersil products are manufactured, assembled and tested utilizing ISO9001 quality systems as noted in the quality certifications found at www.intersil.com/en/support/qualandreliability.html

Intersil products are sold by description only. Intersil may modify the circuit design and/or specifications of products at any time without notice, provided that such modification does not, in Intersil's sole judgment, affect the form, fit or function of the product. Accordingly, the reader is cautioned to verify that datasheets are current before placing orders. Information furnished by Intersil is believed to be accurate and reliable. However, no responsibility is assumed by Intersil or its subsidiaries for its use; nor for any infringements of patents or other rights of third parties which may result from its use. No license is granted by implication or otherwise under any patent or patent rights of Intersil or its subsidiaries.

For information regarding Intersil Corporation and its products, see www.intersil.com

Package Outline Drawing

For the most recent package outline drawing, see [L32.4x4A](#).

L32.4x4A

32 LEAD QUAD FLAT NO-LEAD PLASTIC PACKAGE

Rev 5, 2/16

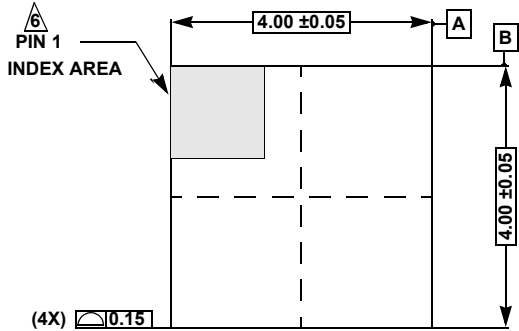

TOP VIEW

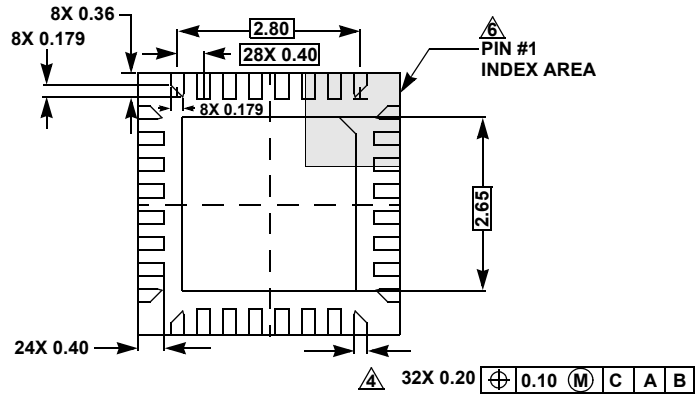

BOTTOM VIEW

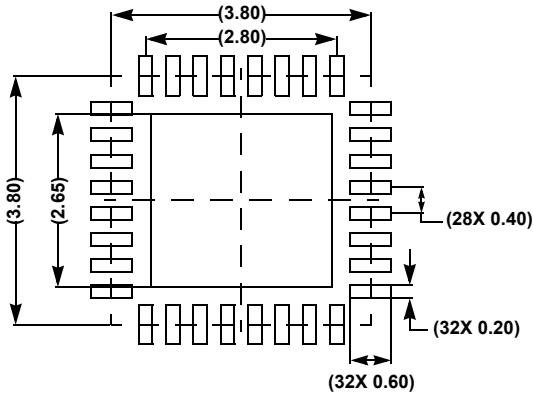

TYPICAL RECOMMENDED LAND PATTERN

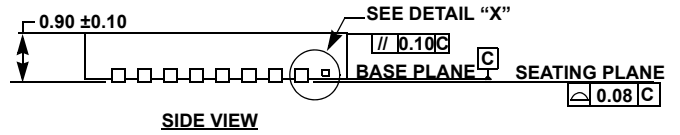

SIDE VIEW

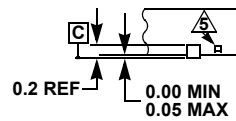

DETAIL "X"

NOTES:

1. Dimensions are in millimeters.
Dimensions in () for Reference Only.
2. Dimensioning and tolerancing conform to ASME Y14.5m-1994.
3. Unless otherwise specified, tolerance: Decimal ±0.05
4. Dimension applies to the metallized terminal and is measured between 0.15mm and 0.25mm from the terminal tip.
5. Tiebar shown (if present) is a non-functional feature.
6. The configuration of the pin #1 identifier is optional, but must be located within the zone indicated. The pin #1 identifier may be either a mold or mark feature.

Looking for pricing, stock, or lifecycle information?

Click below to explore more details on WIN SOURCE:

-  [View ISL9237IRZR5700 on WIN SOURCE](#)
-  [Renesas Electronics America](#) Information

Optimize Your Supply Chain with WIN SOURCE Solutions

-  Global Sourcing Solution
-  Obsolete Management
-  Cost Control Management
-  Shortage Management
-  Alternative Solution
-  Excess Inventory Management