



**THE DATASHEET OF
ISL32478EIBZ-T7A**



ISL32470E, ISL32472E, ISL32475E, ISL32478E

Fault Protected, Extended Common-Mode Range, RS-485/RS-422 Transceivers with $\pm 16.5\text{kV}$ ESD

FN7784
Rev 2.00
Feb 14, 2019

The [ISL32470E](#), [ISL32472E](#), [ISL32475E](#), and [ISL32478E](#) are fault-protected, extended common-mode range differential transceivers that exceed the RS-485 and RS-422 standards for balanced communication. The RS-485 bus pins (driver outputs and receiver inputs) are fault protected against overvoltages up to $\pm 60\text{V}$ and are protected against $\pm 16.5\text{kV}$ ESD strikes without latch-up. Additionally, these transceivers operate in environments with common-mode voltages up to $\pm 15\text{V}$ (exceeds the RS-485 requirement), making this fault-protected RS-485 family one of the most robust on the market.

The transmitters (Tx) deliver an exceptional 2.5V (typical) differential output voltage into the RS-485 specified 54Ω load. This yields better noise immunity than standard RS-485 ICs or allows up to six 120Ω terminations in star topologies.

The receiver (Rx) inputs feature a full fail-safe design that ensures a logic high Rx output if the Rx inputs are floating, shorted, or on a terminated but undriven (idle) bus. The Rx outputs feature high drive levels; typically, 15mA at $V_{OL} = 1\text{V}$ (to ease the design of opto-coupled isolated interfaces).

Half duplex (Rx inputs and Tx outputs multiplexed together) and full duplex pinouts are available. See [Table 1 on page 2](#) for key features and configurations by device number.

For a fault-protected RS-485 transceiver with a $\pm 25\text{V}$ extended common-mode range, see the [ISL32490E](#) and [ISL32483E](#) datasheets.

Related Literature

For a full list of related documents, visit our website:

- [ISL32470E](#), [ISL32472E](#), [ISL32475E](#), and [ISL32478E](#) device pages

Features

- Fault protected RS-485 bus pins Up to $\pm 60\text{V}$
- Extended common-mode range $\pm 15\text{V}$ larger than required for RS-485
- 1/4 unit load for up to 128 devices on the bus
- $\pm 16.5\text{kV}$ HBM ESD protection on RS-485 bus pins
- High transient over-voltage tolerance $\pm 80\text{V}$
- Full fail-safe (open, short, terminated) RS-485 receivers
- High Rx I_{OL} for opto-couplers in isolated designs
- Hot plug circuitry: Tx and Rx outputs remain three-state during power-up/power-down
- RS-485 data rates 250kbps to 15Mbps
- Low quiescent supply current 2.3mA
- Ultra low shutdown supply current 10 μA

Applications

- Utility meters and automated meter reading systems
- High node count RS-485 systems
- PROFIBUS and RS-485 based field bus networks, factory automation
- Security camera networks
- Building lighting and environmental control systems
- Industrial/process control networks

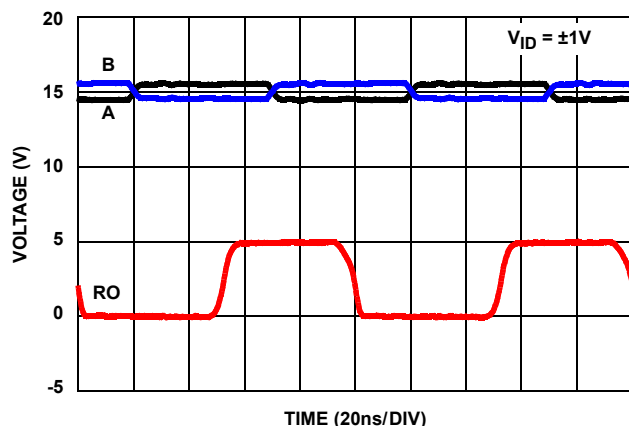

FIGURE 1. EXCEPTIONAL Rx OPERATES AT $>15\text{Mbps}$ EVEN WITH $\pm 15\text{V}$ COMMON-MODE VOLTAGE

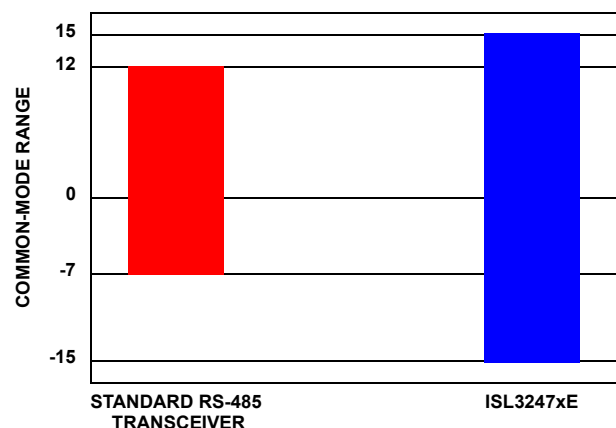

FIGURE 2. TRANSCEIVERS DELIVER SUPERIOR COMMON-MODE RANGE vs STANDARD RS-485 DEVICES

TABLE 1. SUMMARY OF FEATURES

PART NUMBER	HALF/FULL DUPLEX	DATA RATE (Mbps)	SLEW-RATE LIMITED?	EN PINS?	HOT PLUG?	QUIESCENT I _{CC} (mA)	LOW POWER SHUTDOWN?	PIN COUNT
ISL32470E	Full	0.25	Yes	Yes	Yes	2.3	Yes	14
ISL32472E	Half	0.25	Yes	Yes	Yes	2.3	Yes	8
ISL32475E	Half	1	Yes	Yes	Yes	2.3	Yes	8
ISL32478E	Half	15	No	Yes	Yes	2.3	Yes	8

Typical Operating Circuits

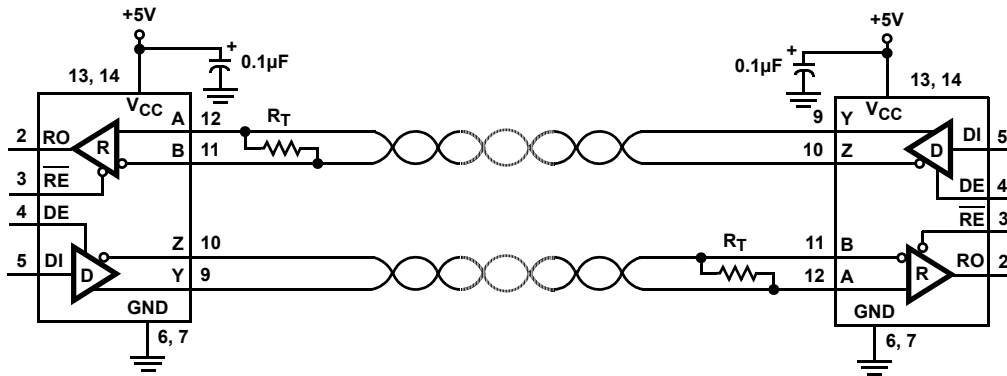

FIGURE 3. ISL32470E FULL DUPLEX EXAMPLE

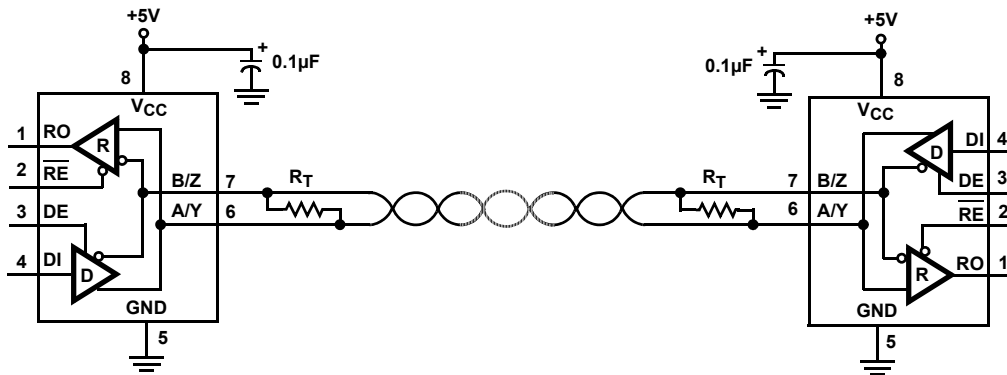

FIGURE 4. ISL32472E, ISL32475E, ISL32478E HALF DUPLEX EXAMPLE

Ordering Information

PART NUMBER (Notes 2, 3)	PART MARKING	TEMP. RANGE (°C)	TAPE AND REEL (Units) (Note 1)	PACKAGE (RoHS Compliant)	PKG. DWG. #
ISL32470EIBZ	ISL32470 EIBZ	-40 to +85	-	14 Ld SOIC	M14.15
ISL32470EIBZ-T	ISL32470 EIBZ	-40 to +85	2.5k	14 Ld SOIC	M14.15
ISL32470EIBZ-T7A	ISL32470 EIBZ	-40 to +85	250	14 Ld SOIC	M14.15
ISL32472EIBZ	32472 EIBZ	-40 to +85	-	8 Ld SOIC	M8.15
ISL32472EIBZ-T	32472 EIBZ	-40 to +85	2.5k	8 Ld SOIC	M8.15
ISL32472EIBZ-T7A	32472 EIBZ	-40 to +85	250	8 Ld SOIC	M8.15
ISL32475EIBZ	32475 EIBZ	-40 to +85	-	8 Ld SOIC	M8.15
ISL32475EIBZ-T	32475 EIBZ	-40 to +85	2.5k	8 Ld SOIC	M8.15
ISL32475EIBZ-T7A	32475 EIBZ	-40 to +85	250	8 Ld SOIC	M8.15
ISL32478EIBZ	32478 EIBZ	-40 to +85	-	8 Ld SOIC	M8.15
ISL32478EIBZ-T	32478 EIBZ	-40 to +85	2.5k	8 Ld SOIC	M8.15
ISL32478EIBZ-T7A	32478 EIBZ	-40 to +85	250	8 Ld SOIC	M8.15

NOTES:

1. See [TB347](#) for details about reel specifications.
2. These Pb-free plastic packaged products employ special Pb-free material sets, molding compounds/die attach materials, and 100% matte tin plate plus anneal (e3 termination finish, which is RoHS compliant and compatible with both SnPb and Pb-free soldering operations).Pb-free products are MSL classified at Pb-free peak reflow temperatures that meet or exceed the Pb-free requirements of IPC/JEDEC J STD-Q20.
3. For Moisture Sensitivity Level (MSL), see the [ISL32470E](#), [ISL32472E](#), [ISL32475E](#), [ISL32478E](#) device pages. For more information about MSL, see [TB363](#).

Pin Configurations

ISL32472E, ISL32475E, ISL32478E
(8 LD SOIC)
TOP VIEW

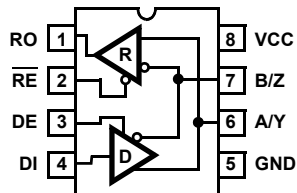

ISL32470E
(14 LD SOIC)
TOP VIEW

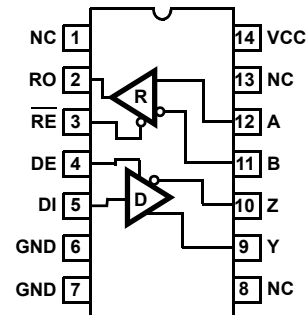

Pin Descriptions

PIN NAME	8 LD PIN #	14 LD PIN #	FUNCTION
RO	1	2	Receiver output. If $A-B \geq 10\text{mV}$, RO is high; if $A-B \leq 200\text{mV}$, RO is low; RO = high if A and B are unconnected (floating), shorted together, or connected to an undriven, terminated bus.
$\overline{\text{RE}}$	2	3	Receiver output enable. RO is enabled when $\overline{\text{RE}}$ is low; RO is high impedance when $\overline{\text{RE}}$ is high. Internally pulled low.
DE	3	4	Driver output enable. The driver outputs, Y and Z, are enabled by bringing DE high. They are high impedance when DE is low. Internally pulled high.
DI	4	5	Driver input. A low on DI forces output Y low and output Z high. A high on DI forces output Y high and output Z low.
GND	5	6, 7	Ground connection.
A/Y	6	-	$\pm 60\text{V}$ fault and $\pm 16.5\text{kV}$ HBM ESD protected, RS-485/RS-422 level, non-inverting receiver input and non-inverting driver output. Pin is an input if DE = 0; pin is an output if DE = 1.
B/Z	7	-	$\pm 60\text{V}$ fault and $\pm 16.5\text{kV}$ HBM ESD protected, RS-485/RS-422 level, inverting receiver input and inverting driver output. Pin is an input if DE = 0; pin is an output if DE = 1.
A	-	12	$\pm 60\text{V}$ fault and $\pm 15\text{kV}$ HBM ESD protected, RS-485/RS-422 level, non-inverting receiver input.
B	-	11	$\pm 60\text{V}$ fault and $\pm 15\text{kV}$ HBM ESD protected, RS-485/RS-422 level, inverting receiver input.
Y	-	9	$\pm 60\text{V}$ fault and $\pm 15\text{kV}$ HBM ESD protected, RS-485/RS-422 level, non-inverting driver output.
Z	-	10	$\pm 60\text{V}$ fault and $\pm 15\text{kV}$ HBM ESD protected, RS-485/RS-422 level, inverting driver output.
VCC	8	14	System power supply input (4.5V to 5.5V).
NC	-	1, 8, 13	No internal connection.

Truth Tables

TRANSMITTING				
INPUTS			OUTPUTS	
RE	DE	DI	Z	Y
X	1	1	0	1
X	1	0	1	0
0	0	X	High-Z	High-Z
1	0	X	High-Z (Note 4)	High-Z (Note 4)

NOTE:

4. Low Power Shutdown Mode (see [Note 13 on page 9](#)).

RECEIVING				
INPUTS				OUTPUT
RE	DE Half Duplex	DE Full Duplex	A-B	RO
0	0	X	$\geq -0.01\text{V}$	1
0	0	X	$\leq -0.2\text{V}$	0
0	0	X	Inputs Open/Shorted	1
1	0	0	X	High-Z (see Note 5)
1	1	1	X	High-Z

NOTE:

5. Low Power Shutdown Mode (see [Note 13 on page 9](#)).

Absolute Maximum Ratings

V _{CC} to Ground	7V
Input Voltages	
DI, DE, \overline{RE}	-0.3V to (V _{CC} + 0.3V)
Input/Output Voltages	
A/Y, B/Z, A, B, Y, Z	±60V
A/Y, B/Z, A, B, Y, Z (Transient Pulse Through 100Ω, Note 17)	±80V
RO	-0.3V to (V _{CC} + 0.3V)
Short-Circuit Duration	
Y, Z	Indefinite
ESD Rating	see "ESD PERFORMANCE" on page 6
Latch-Up (per JEDEC78, Level 2, Class A)	+125°C

Thermal Information

Thermal Resistance (Typical)	θ_{JA} (°C/W)	θ_{JC} (°C/W)
8 Ld SOIC Package (Notes 6, 7)	108	47
14 Ld SOIC Package (Notes 6, 7)	88	39
Maximum Junction Temperature (Plastic Package)	+150°C	
Maximum Storage Temperature Range	-65°C to +150°C	
Pb-Free Reflow Profile	see TB493	

Recommended Operating Conditions

Supply Voltage (V _{CC})	5V
Temperature Range	-40°C to +85°C
Bus Pin Common-Mode Voltage Range	-15V to +15V

CAUTION: Do not operate at or near the maximum ratings listed for extended periods of time. Exposure to such conditions can adversely impact product reliability and result in failures not covered by warranty.

NOTES:

- θ_{JA} is measured with the component mounted on a high-effective thermal conductivity test board in free air. See [TB379](#) for details.
- For θ_{JC} , the "case temp" location is taken at the package top center.

Electrical Specifications Test Conditions: V_{CC} = 4.5V to 5.5V; unless otherwise specified. Typical values are V_{CC} = 5V, T_A = +25°C ([Note 8](#)). **Boldface limits apply over the operating temperature range, -40°C to +85°C.**

PARAMETER	SYMBOL	TEST CONDITIONS	TEMP (°C)	MIN (Note 16)	TYP	MAX (Note 16)	UNIT
DC CHARACTERISTICS							
Driver Differential V _{OUT} (No load)	V _{OD1}		Full	-	-	V _{CC}	V
Driver Differential V _{OUT} (Loaded, Figure 5A)	V _{OD2}	R _L = 100Ω (RS-422)	Full	2.4	3.2	-	V
		R _L = 54Ω (RS-485)	Full	1.5	2.5	V _{CC}	V
		R _L = 54Ω (PROFIBUS, V _{CC} ≥ 5V)	Full	2.0	2.5	-	V
		R _L = 21Ω (six 120Ω terminations for star configurations, V _{CC} ≥ 4.75V)	Full	0.8	1.3	-	V
Change in Magnitude of Driver Differential V _{OUT} for Complementary Output States	ΔV _{OD}	R _L = 54Ω or 100Ω (Figure 5A)	Full	-	-	0.2	V
Driver Differential V _{OUT} with Common-Mode Load (Figure 5B)	V _{OD3}	R _L = 60Ω, -7V ≤ V _{CM} ≤ 12V	Full	1.5	2.1	V _{CC}	V
		R _L = 60Ω, -15V ≤ V _{CM} ≤ 15V (V _{CC} ≥ 4.75V)	Full	1.7	2.3	-	V
Driver Common-Mode V _{OUT} (Figure 5A)	V _{OC}	R _L = 54Ω or 100Ω	Full	-1	-	3	V
Change in Magnitude of Driver Common-Mode V _{OUT} for Complementary Output States	ΔV _{OC}	R _L = 54Ω or 100Ω (Figure 5A)	Full	-	-	0.2	V
Driver Short-Circuit Current	I _{OSD}	DE = V _{CC} , -15V ≤ V _O ≤ 15V (Note 10)	Full	-250	-	250	mA
	I _{OSD1}	At first foldback, 22V ≤ V _O ≤ -22V	Full	-83	-	83	mA
	I _{OSD2}	At second foldback, 35V ≤ V _O ≤ -35V	Full	-13	-	13	mA
Logic Input High Voltage	V _{IH}	DE, DI, \overline{RE}	Full	2.5	-	-	V
Logic Input Low Voltage	V _{IL}	DE, DI, \overline{RE}	Full	-	-	0.8	V
Logic Input Current	I _{IN1}	DI	Full	-1	-	1	μA
		DE, \overline{RE}	Full	-15	6	15	μA

Electrical Specifications Test Conditions: $V_{CC} = 4.5V$ to $5.5V$; unless otherwise specified. Typical values are $V_{CC} = 5V$, $T_A = +25^\circ C$ (Note 8). Boldface limits apply over the operating temperature range, $-40^\circ C$ to $+85^\circ C$. (Continued)

PARAMETER	SYMBOL	TEST CONDITIONS	TEMP ($^\circ C$)	MIN (Note 16)	TYP	MAX (Note 16)	UNIT	
Input/Output Current (A/Y, B/Z)	I_{IN2}	DE = 0V, $V_{CC} = 0V$ or 5.5V	$V_{IN} = 12V$	Full	-	110	250	μA
			$V_{IN} = -7V$	Full	-200	-75	-	μA
			$V_{IN} = \pm 15V$	Full	-800	± 240	800	μA
			$V_{IN} = \pm 60V$ (Note 18)	Full	-6	± 0.5	6	mA
Input Current (A, B) (Full Duplex Versions Only)	I_{IN3}	$V_{CC} = 0V$ or 5.5V	$V_{IN} = 12V$	Full	-	90	125	μA
			$V_{IN} = -7V$	Full	-100	-70	-	μA
			$V_{IN} = \pm 15V$	Full	-500	± 200	500	μA
			$V_{IN} = \pm 60V$ (Note 18)	Full	-3	± 0.4	3	mA
Output Leakage Current (Y, Z) (Full Duplex Versions Only)	I_{OZD}	$\overline{RE} = 0V$, DE = 0V, $V_{CC} = 0V$ or 5.5V	$V_{IN} = 12V$	Full	-	20	200	μA
			$V_{IN} = -7V$	Full	-100	-5	-	μA
			$V_{IN} = \pm 15V$	Full	-500	± 40	500	μA
			$V_{IN} = \pm 60V$ (Note 18)	Full	-3	± 0.1	3	mA
Receiver Differential Threshold Voltage	V_{TH}	$-15V \leq V_{CM} \leq 15V$	Full	-200	-100	-10	mV	
Receiver Input Hysteresis	ΔV_{TH}	$-15V \leq V_{CM} \leq 15V$	25	-	25	-	mV	
Receiver Output High Voltage	V_{OH}	$I_O = -2mA$, $V_{ID} = -10mV$	Full	$V_{CC} - 0.5$	4.75	-	V	
		$I_O = -8mA$, $V_{ID} = -10mV$	Full	2.8	4.2	-	V	
Receiver Output Low Voltage	V_{OL}	$I_O = 6mA$, $V_{ID} = -200mV$	Full	-	0.27	0.4	V	
Receiver Output Low Current	I_{OL}	$V_O = 1V$, $V_{ID} = -200mV$	Full	15	22	-	mA	
Three-State (High Impedance) Receiver Output Current	I_{OZR}	$0V \leq V_O \leq V_{CC}$	Full	-1	0.01	1	μA	
Receiver Short-Circuit Current	I_{OSR}	$0V \leq V_O \leq V_{CC}$	Full	± 12	-	± 110	mA	
SUPPLY CURRENT								
No-Load Supply Current (Note 9)	I_{CC}	DE = V_{CC} , $\overline{RE} = 0V$ or V_{CC} , DI = 0V or V_{CC}	Full	-	2.3	4.5	mA	
Shutdown Supply Current	I_{SHDN}	DE = 0V, $\overline{RE} = V_{CC}$, DI = 0V or V_{CC}	Full	-	10	50	μA	
ESD PERFORMANCE								
RS-485 Pins (A, Y, B, Z, A/Y, B/Z)		Human Body Model, from Bus Pins to GND	1/2 Duplex	25	-	± 16.5	-	kV
			Full Duplex	25	-	± 15	-	kV
All Pins		Human Body Model, per JEDEC	25	-	± 8	-	kV	
		Machine Model	25	-	± 700	-	V	
DRIVER SWITCHING CHARACTERISTICS (250kbps Versions; ISL32470E and ISL32472E)								
Driver Differential Output Delay	t_{PLH} , t_{PHL}	$R_D = 54\Omega$, $C_D = 50pF$ (Figure 6)	Full	-	320	450	ns	
Driver Differential Output Skew	t_{SKEW}	$R_D = 54\Omega$, $C_D = 50pF$ (Figure 6)	Full	-	6	30	ns	
Driver Differential Rise or Fall Time	t_R , t_F	$R_D = 54\Omega$, $C_D = 50pF$ (Figure 6)	Full	400	650	1200	ns	

Electrical Specifications Test Conditions: $V_{CC} = 4.5V$ to $5.5V$; unless otherwise specified. Typical values are $V_{CC} = 5V$, $T_A = +25^\circ C$ (Note 8). Boldface limits apply over the operating temperature range, $-40^\circ C$ to $+85^\circ C$. (Continued)

PARAMETER	SYMBOL	TEST CONDITIONS	TEMP ($^\circ C$)	MIN (Note 16)	TYP	MAX (Note 16)	UNIT
Maximum Data Rate	f_{MAX}	$C_D = 820pF$ (Figure 8)	Full	0.25	1.5	-	Mbps
Driver Enable to Output High	t_{ZH}	SW = GND (Figure 7), (Note 11)	Full	-	-	1200	ns
Driver Enable to Output Low	t_{ZL}	SW = V_{CC} (Figure 7), (Note 11)	Full	-	-	1200	ns
Driver Disable from Output Low	t_{LZ}	SW = V_{CC} (Figure 7)	Full	-	-	120	ns
Driver Disable from Output High	t_{HZ}	SW = GND (Figure 7)	Full	-	-	120	ns
Time to Shutdown	t_{SHDN}	(Note 13)	Full	60	160	600	ns
Driver Enable from Shutdown to Output High	$t_{ZH(SHDN)}$	SW = GND (Figure 7), (Notes 13, 14)	Full	-	-	2500	ns
Driver Enable from Shutdown to Output Low	$t_{ZL(SHDN)}$	SW = V_{CC} (Figure 7), (Notes 13, 14)	Full	-	-	2500	ns

DRIVER SWITCHING CHARACTERISTICS (1Mbps Versions; ISL32475E)

Driver Differential Output Delay	t_{PLH}, t_{PHL}	$R_D = 54\Omega, C_D = 50pF$ (Figure 6)	Full	-	70	125	ns
Driver Differential Output Skew	t_{SKEW}	$R_D = 54\Omega, C_D = 50pF$ (Figure 6)	Full	-	4.5	15	ns
Driver Differential Rise or Fall Time	t_R, t_F	$R_D = 54\Omega, C_D = 50pF$ (Figure 6)	Full	70	170	300	ns
Maximum Data Rate	f_{MAX}	$C_D = 820pF$ (Figure 8)	Full	1	4	-	Mbps
Driver Enable to Output High	t_{ZH}	SW = GND (Figure 7), (Note 11)	Full	-	-	350	ns
Driver Enable to Output Low	t_{ZL}	SW = V_{CC} (Figure 7), (Note 11)	Full	-	-	300	ns
Driver Disable from Output Low	t_{LZ}	SW = V_{CC} (Figure 7)	Full	-	-	120	ns
Driver Disable from Output High	t_{HZ}	SW = GND (Figure 7)	Full	-	-	120	ns
Time to Shutdown	t_{SHDN}	(Note 13)	Full	60	160	600	ns
Driver Enable from Shutdown to Output High	$t_{ZH(SHDN)}$	SW = GND (Figure 7), (Notes 13, 14)	Full	-	-	2000	ns
Driver Enable from Shutdown to Output Low	$t_{ZL(SHDN)}$	SW = V_{CC} (Figure 7), (Notes 13, 14)	Full	-	-	2000	ns

DRIVER SWITCHING CHARACTERISTICS (15Mbps Versions; ISL32478E)

Driver Differential Output Delay	t_{PLH}, t_{PHL}	$R_D = 54\Omega, C_D = 50pF$ (Figure 6)	Full	-	21	45	ns
Driver Differential Output Skew	t_{SKEW}	$R_D = 54\Omega, C_D = 50pF$ (Figure 6)	Full	-	3	6	ns
Driver Differential Rise or Fall Time	t_R, t_F	$R_D = 54\Omega, C_D = 50pF$ (Figure 6)	Full	5	17	30	ns
Maximum Data Rate	f_{MAX}	$C_D = 470pF$ (Figure 8)	Full	15	25	-	Mbps
Driver Enable to Output High	t_{ZH}	SW = GND (Figure 7), (Note 11)	Full	-	-	100	ns
Driver Enable to Output Low	t_{ZL}	SW = V_{CC} (Figure 7), (Note 11)	Full	-	-	100	ns
Driver Disable from Output Low	t_{LZ}	SW = V_{CC} (Figure 7)	Full	-	-	120	ns
Driver Disable from Output High	t_{HZ}	SW = GND (Figure 7)	Full	-	-	120	ns
Time to Shutdown	t_{SHDN}	(Note 13)	Full	60	160	600	ns
Driver Enable from Shutdown to Output High	$t_{ZH(SHDN)}$	SW = GND (Figure 7), (Notes 13, 14)	Full	-	-	2000	ns
Driver Enable from Shutdown to Output Low	$t_{ZL(SHDN)}$	SW = V_{CC} (Figure 7), (Notes 13, 14)	Full	-	-	2000	ns

Electrical Specifications Test Conditions: $V_{CC} = 4.5V$ to $5.5V$; unless otherwise specified. Typical values are $V_{CC} = 5V$, $T_A = +25^\circ C$ (Note 8). Boldface limits apply over the operating temperature range, $-40^\circ C$ to $+85^\circ C$. (Continued)

PARAMETER	SYMBOL	TEST CONDITIONS	TEMP ($^\circ C$)	MIN (Note 16)	TYP	MAX (Note 16)	UNIT
RECEIVER SWITCHING CHARACTERISTICS (250kbps Versions; ISL32470E and ISL32472E)							
Maximum Data Rate	f_{MAX}	(Figure 9)	Full	0.25	5	-	Mbps
Receiver Input to Output Delay	t_{PLH} , t_{PHL}	(Figure 9)	Full	-	200	280	ns
Receiver Skew $t_{PLH} - t_{PHL}$	t_{SKD}	(Figure 9)	Full	-	4	10	ns
Receiver Enable to Output Low	t_{ZL}	$R_L = 1k\Omega$, $C_L = 15pF$, $SW = V_{CC}$ (Figure 10), (Note 12)	Full	-	-	50	ns
Receiver Enable to Output High	t_{ZH}	$R_L = 1k\Omega$, $C_L = 15pF$, $SW = GND$ (Figure 10), (Note 12)	Full	-	-	50	ns
Receiver Disable from Output Low	t_{LZ}	$R_L = 1k\Omega$, $C_L = 15pF$, $SW = V_{CC}$ (Figure 10)	Full	-	-	50	ns
Receiver Disable from Output High	t_{HZ}	$R_L = 1k\Omega$, $C_L = 15pF$, $SW = GND$ (Figure 10)	Full	-	-	50	ns
Time to Shutdown	t_{SHDN}	(Note 13)	Full	60	160	600	ns
Receiver Enable from Shutdown to Output High	$t_{ZH(SHDN)}$	$R_L = 1k\Omega$, $C_L = 15pF$, $SW = GND$ (Figure 10), (Notes 13, 15)	Full	-	-	2000	ns
Receiver Enable from Shutdown to Output Low	$t_{ZL(SHDN)}$	$R_L = 1k\Omega$, $C_L = 15pF$, $SW = V_{CC}$ (Figure 10), (Notes 13, 15)	Full	-	-	2000	ns
RECEIVER SWITCHING CHARACTERISTICS (1Mbps Versions; ISL32475E)							
Maximum Data Rate	f_{MAX}	(Figure 9)	Full	1	15	-	Mbps
Receiver Input to Output Delay	t_{PLH} , t_{PHL}	(Figure 9)	Full	-	90	150	ns
Receiver Skew $t_{PLH} - t_{PHL}$	t_{SKD}	(Figure 9)	Full	-	4	10	ns
Receiver Enable to Output Low	t_{ZL}	$R_L = 1k\Omega$, $C_L = 15pF$, $SW = V_{CC}$ (Figure 10), (Note 12)	Full	-	-	50	ns
Receiver Enable to Output High	t_{ZH}	$R_L = 1k\Omega$, $C_L = 15pF$, $SW = GND$ (Figure 10), (Note 12)	Full	-	-	50	ns
Receiver Disable from Output Low	t_{LZ}	$R_L = 1k\Omega$, $C_L = 15pF$, $SW = V_{CC}$ (Figure 10)	Full	-	-	50	ns
Receiver Disable from Output High	t_{HZ}	$R_L = 1k\Omega$, $C_L = 15pF$, $SW = GND$ (Figure 10)	Full	-	-	50	ns
Time to Shutdown	t_{SHDN}	(Note 13)	Full	60	160	600	ns
Receiver Enable from Shutdown to Output High	$t_{ZH(SHDN)}$	$R_L = 1k\Omega$, $C_L = 15pF$, $SW = GND$ (Figure 10), (Notes 13, 15)	Full	-	-	2000	ns
Receiver Enable from Shutdown to Output Low	$t_{ZL(SHDN)}$	$R_L = 1k\Omega$, $C_L = 15pF$, $SW = V_{CC}$ (Figure 10), (Notes 13, 15)	Full	-	-	2000	ns
RECEIVER SWITCHING CHARACTERISTICS (15Mbps Versions; ISL32478E)							
Maximum Data Rate	f_{MAX}	(Figure 9)	Full	15	25	-	Mbps
Receiver Input to Output Delay	t_{PLH} , t_{PHL}	(Figure 9)	Full	-	35	70	ns
Receiver Skew $t_{PLH} - t_{PHL}$	t_{SKD}	(Figure 9)	Full	-	4	10	ns
Receiver Enable to Output Low	t_{ZL}	$R_L = 1k\Omega$, $C_L = 15pF$, $SW = V_{CC}$ (Figure 10), (Note 12)	Full	-	-	50	ns
Receiver Enable to Output High	t_{ZH}	$R_L = 1k\Omega$, $C_L = 15pF$, $SW = GND$ (Figure 10), (Note 12)	Full	-	-	50	ns
Receiver Disable from Output Low	t_{LZ}	$R_L = 1k\Omega$, $C_L = 15pF$, $SW = V_{CC}$ (Figure 10)	Full	-	-	50	ns
Receiver Disable from Output High	t_{HZ}	$R_L = 1k\Omega$, $C_L = 15pF$, $SW = GND$ (Figure 10)	Full	-	-	50	ns

Electrical Specifications Test Conditions: $V_{CC} = 4.5V$ to $5.5V$; unless otherwise specified. Typical values are $V_{CC} = 5V$, $T_A = +25^\circ C$ (Note 8). Boldface limits apply over the operating temperature range, $-40^\circ C$ to $+85^\circ C$. (Continued)

PARAMETER	SYMBOL	TEST CONDITIONS	TEMP (°C)	MIN (Note 16)	TYP	MAX (Note 16)	UNIT
Time to Shutdown	t_{SHDN}	(Note 13)	Full	60	160	600	ns
Receiver Enable from Shutdown to Output High	$t_{ZH(SHDN)}$	$R_L = 1k\Omega$, $C_L = 15pF$, $SW = GND$ (Figure 10), (Notes 13, 15)	Full	-	-	2000	ns
Receiver Enable from Shutdown to Output Low	$t_{ZL(SHDN)}$	$R_L = 1k\Omega$, $C_L = 15pF$, $SW = V_{CC}$ (Figure 10), (Notes 13, 15)	Full	-	-	2000	ns

NOTES:

8. All currents into device pins are positive; all currents out of device pins are negative. All voltages are referenced to device ground unless otherwise specified.
9. Supply current specification is valid for loaded drivers when $DE = 0V$.
10. Applies to peak current. See "Typical Performance Curves" beginning on page 5 for more information.
11. Keep $\overline{RE} = 0$ to prevent the device from entering shutdown.
12. The \overline{RE} signal high time must be short enough (typically $<100ns$) to prevent the device from entering shutdown.
13. Transceivers are put into shutdown by bringing \overline{RE} high and DE low. If the inputs are in this state for less than $60ns$, the parts are ensured not to enter shutdown. If the inputs are in this state for at least $600ns$, the parts are ensured to enter shutdown. See "Low Power Shutdown Mode" on page 17.
14. Keep $\overline{RE} = V_{CC}$ and set the DE signal low time $>600ns$ to ensure that the device enters shutdown.
15. Set the \overline{RE} signal high time $>600ns$ to ensure that the device enters shutdown.
16. Compliance to datasheet limits is assured by one or more methods: production test, characterization, and/or design.
17. Tested according to TIA/EIA-485-A, Section 4.2.6 ($\pm 80V$ for $15\mu s$ at a 1% duty cycle).
18. See the Caution statement in "Absolute Maximum Ratings" on page 5.

Test Circuits and Waveforms

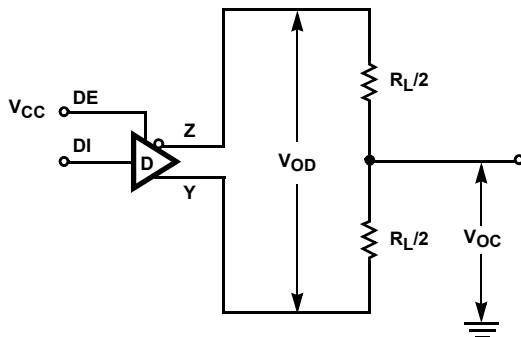

FIGURE 5A. V_{OD} AND V_{OC}

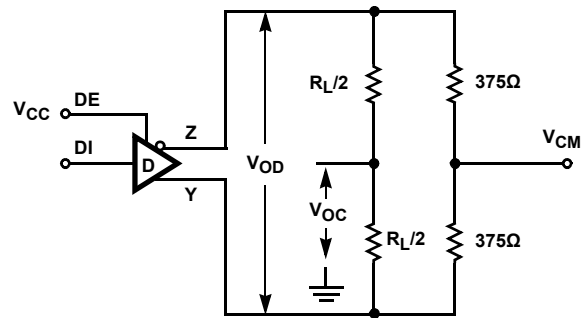

FIGURE 5B. V_{OD} AND V_{OC} WITH COMMON-MODE LOAD

FIGURE 5. DC DRIVER TEST CIRCUITS

Test Circuits and Waveforms (Continued)

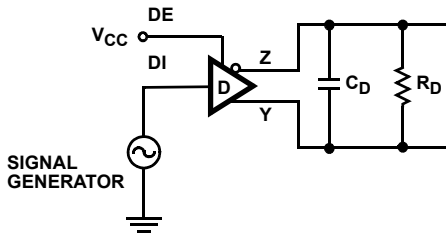

FIGURE 6A. TEST CIRCUIT

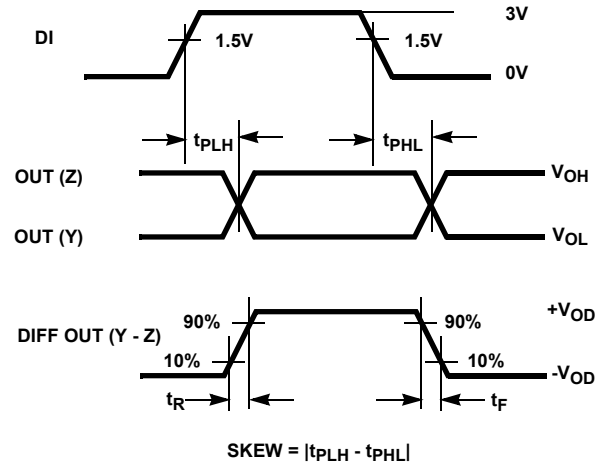

FIGURE 6B. MEASUREMENT POINTS

FIGURE 6. DRIVER PROPAGATION DELAY AND DIFFERENTIAL TRANSITION TIMES

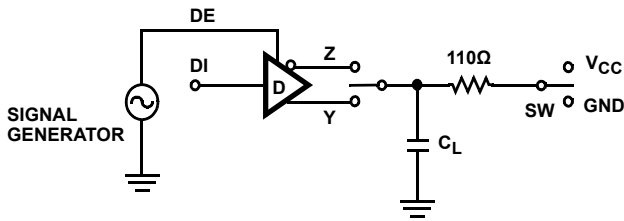

FIGURE 7A. TEST CIRCUIT

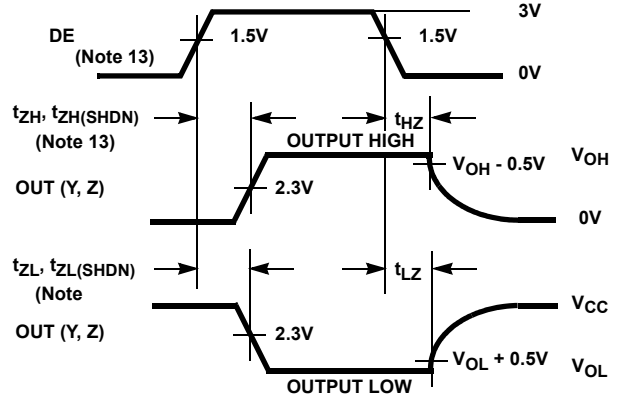

FIGURE 7B. MEASUREMENT POINTS

FIGURE 7. DRIVER ENABLE AND DISABLE TIMES

PARAMETER	OUTPUT	RE	DI	SW	CL (pF)
t _{HZ}	Y/Z	X	1/0	GND	50
t _{LZ}	Y/Z	X	0/1	V _{CC}	50
t _{ZH}	Y/Z	0 (Note 11)	1/0	GND	100
t _{ZL}	Y/Z	0 (Note 11)	0/1	V _{CC}	100
t _{ZH(SHDN)}	Y/Z	1 (Note 14)	1/0	GND	100
t _{ZL(SHDN)}	Y/Z	1 (Note 14)	0/1	V _{CC}	100

FIGURE 8A. TEST CIRCUIT

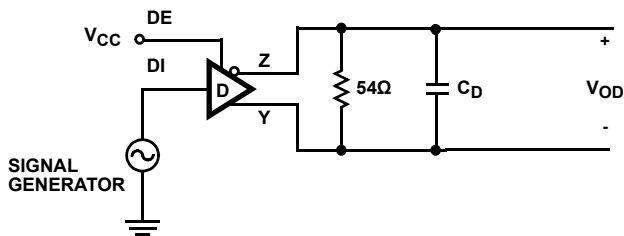

FIGURE 8A. TEST CIRCUIT

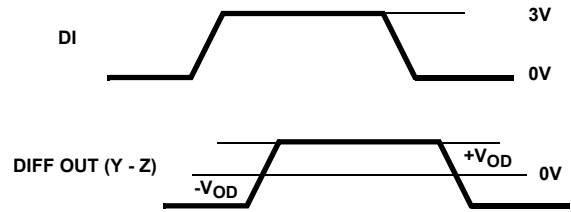

FIGURE 8B. MEASUREMENT POINTS

FIGURE 8. DRIVER DATA RATE

Test Circuits and Waveforms (Continued)

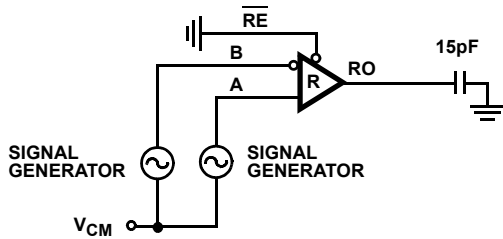

FIGURE 9A. TEST CIRCUIT

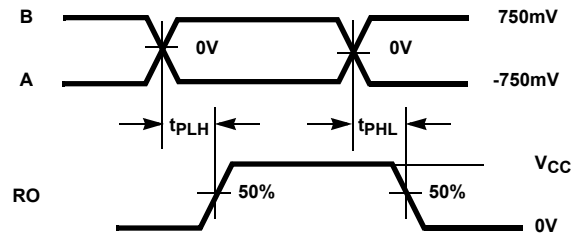
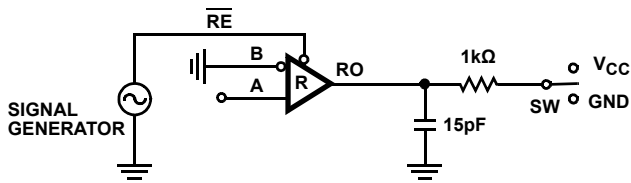

FIGURE 9B. MEASUREMENT POINTS

FIGURE 9. RECEIVER PROPAGATION DELAY AND DATA RATE



PARAMETER	DE	A	SW
t_{HZ}	0	+1.5V	GND
t_{LZ}	0	-1.5V	V_{CC}
t_{ZH} (Note 12)	0	+1.5V	GND
t_{ZL} (Note 12)	0	-1.5V	V_{CC}
$t_{ZH(SHDN)}$ (Note 15)	0	+1.5V	GND
$t_{ZL(SHDN)}$ (Note 15)	0	-1.5V	V_{CC}

FIGURE 10A. TEST CIRCUIT

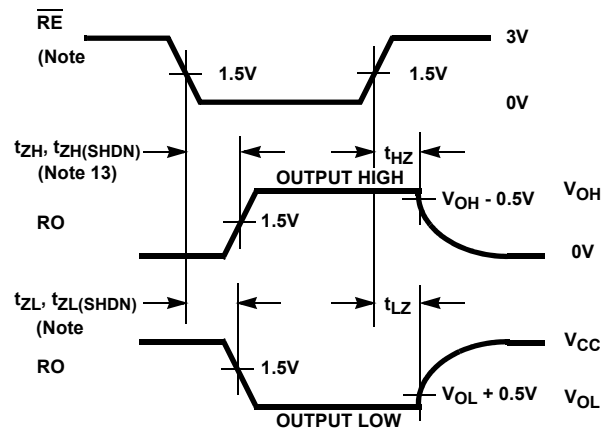

FIGURE 10B. MEASUREMENT POINTS

FIGURE 10. RECEIVER ENABLE AND DISABLE TIMES

Typical Performance Curves $V_{CC} = 5V, T_A = +25^\circ C$; unless otherwise specified.

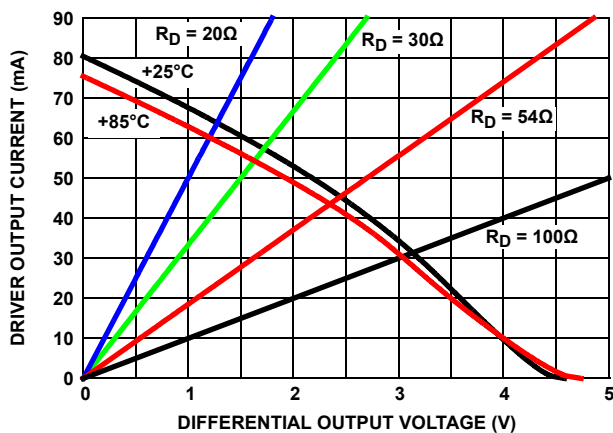

FIGURE 11. DRIVER OUTPUT CURRENT vs DIFFERENTIAL OUTPUT VOLTAGE

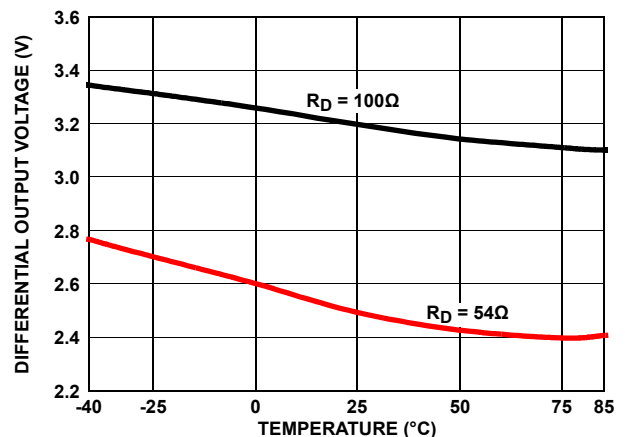

FIGURE 12. DRIVER DIFFERENTIAL OUTPUT VOLTAGE vs TEMPERATURE

Typical Performance Curves $V_{CC} = 5V$, $T_A = +25^\circ C$; unless otherwise specified. (Continued)

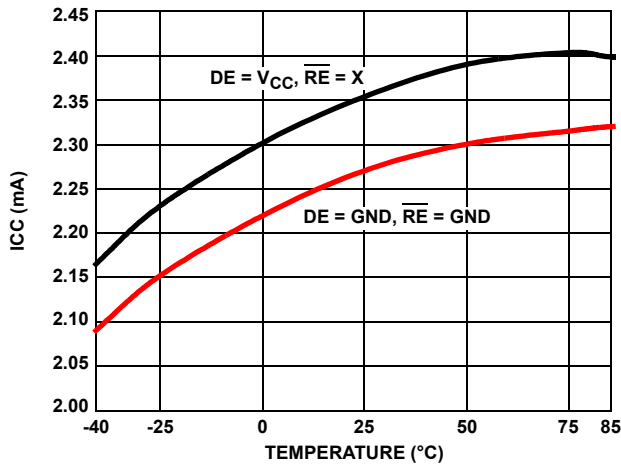

FIGURE 13. SUPPLY CURRENT vs TEMPERATURE

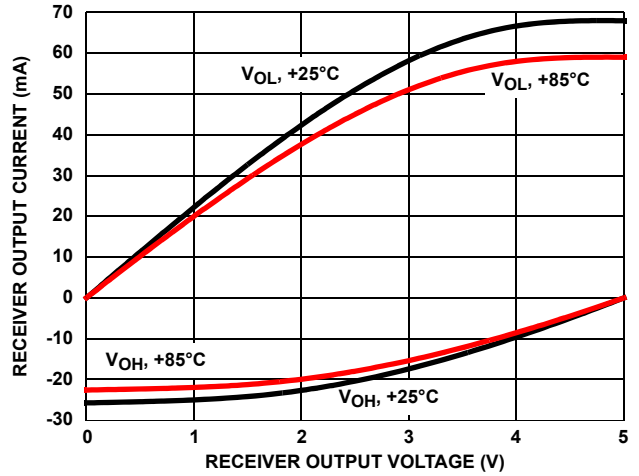

FIGURE 14. RECEIVER OUTPUT CURRENT vs RECEIVER OUTPUT VOLTAGE

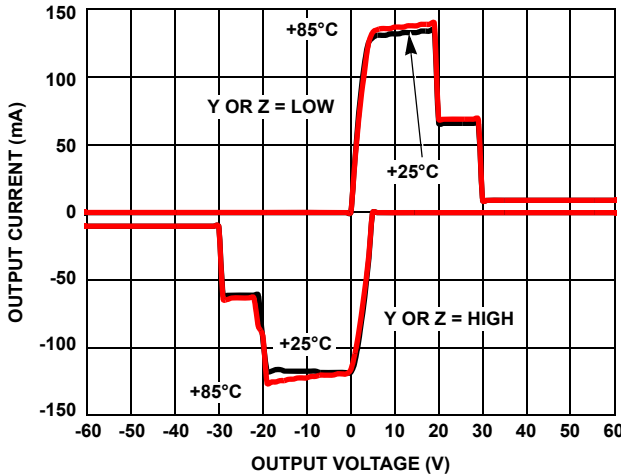

FIGURE 15. DRIVER OUTPUT CURRENT vs SHORT-CIRCUIT VOLTAGE

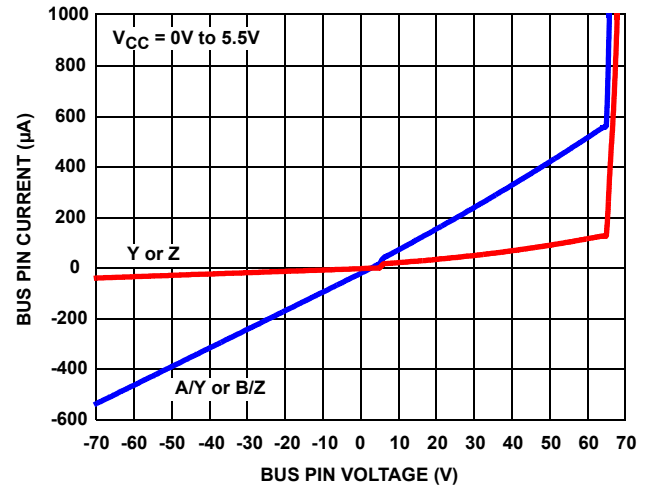

FIGURE 16. BUS PIN CURRENT vs BUS PIN VOLTAGE

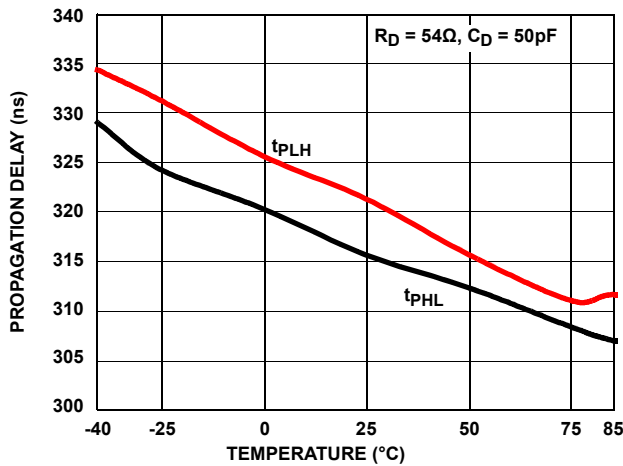

FIGURE 17. DRIVER DIFFERENTIAL PROPAGATION DELAY vs TEMPERATURE (ISL32470E, ISL32472E)

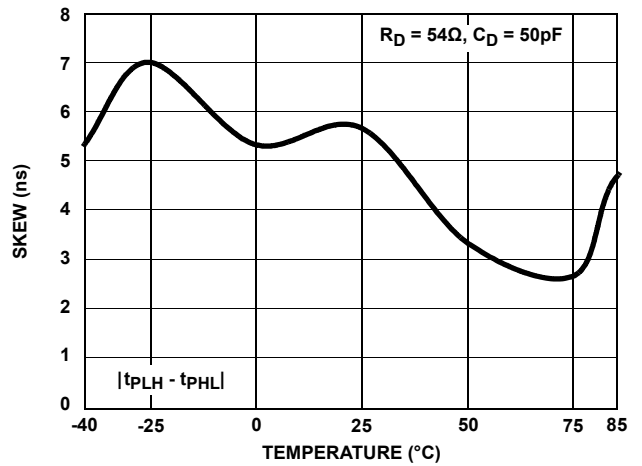

FIGURE 18. DRIVER DIFFERENTIAL SKEW vs TEMPERATURE (ISL32470E, ISL32472E)

Typical Performance Curves $V_{CC} = 5V, T_A = +25^\circ C$; unless otherwise specified. (Continued)

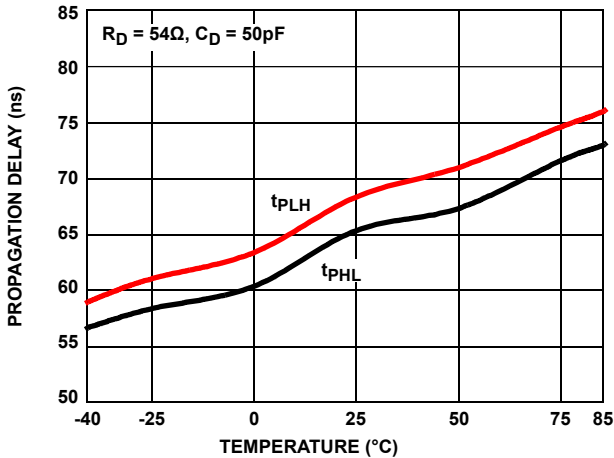

FIGURE 19. DRIVER DIFFERENTIAL PROPAGATION DELAY vs TEMPERATURE (ISL32475E)

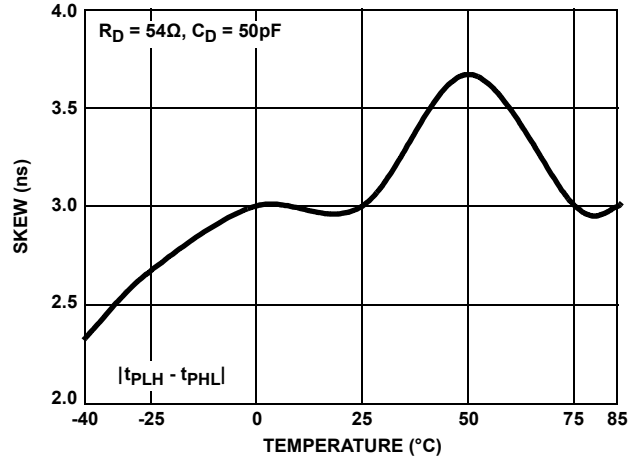

FIGURE 20. DRIVER DIFFERENTIAL SKEW vs TEMPERATURE (ISL32475E)

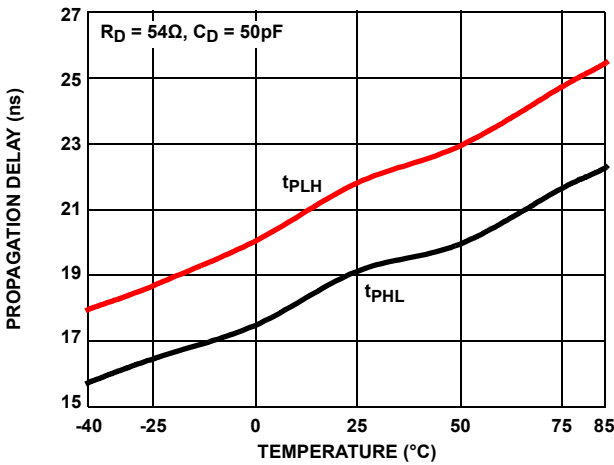

FIGURE 21. DRIVER DIFFERENTIAL PROPAGATION DELAY vs TEMPERATURE (ISL32478E)

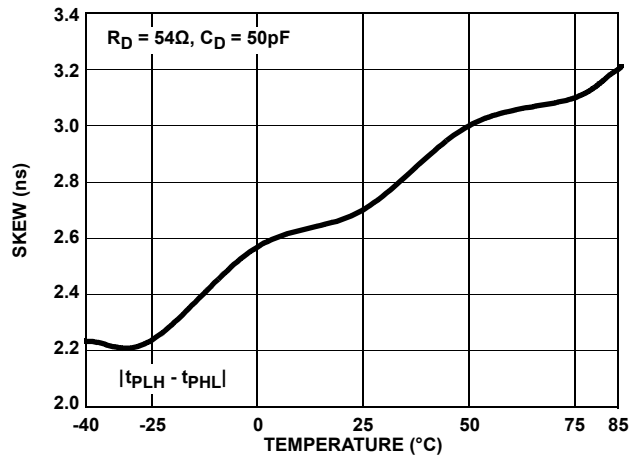

FIGURE 22. DRIVER DIFFERENTIAL SKEW vs TEMPERATURE (ISL32478E)

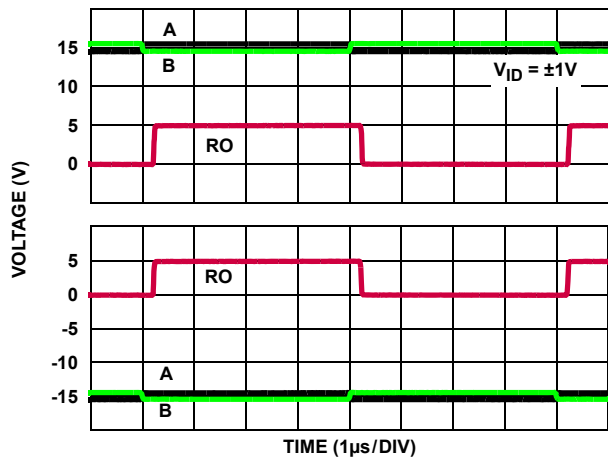

FIGURE 23. RECEIVER PERFORMANCE WITH $\pm 15V$ CMV (ISL32470E, ISL32472E)

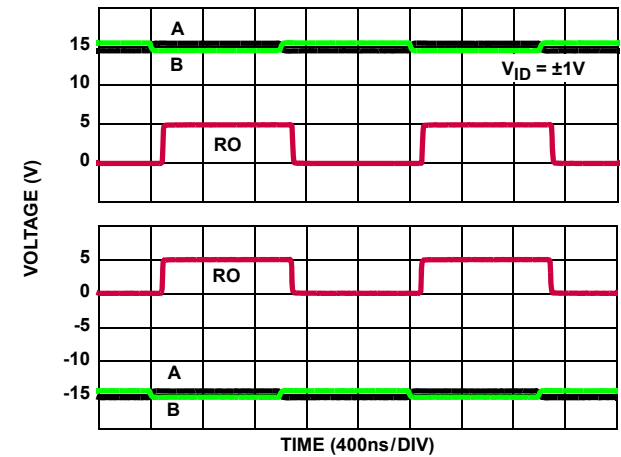

FIGURE 24. RECEIVER PERFORMANCE WITH $\pm 15V$ CMV (ISL32475E)

Typical Performance Curves $V_{CC} = 5V, T_A = +25^\circ C$; unless otherwise specified. (Continued)

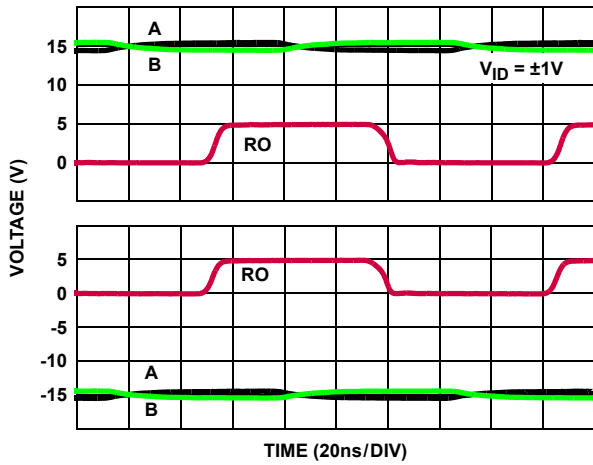

FIGURE 25. RECEIVER PERFORMANCE WITH $\pm 15V$ CMV (ISL32478E)

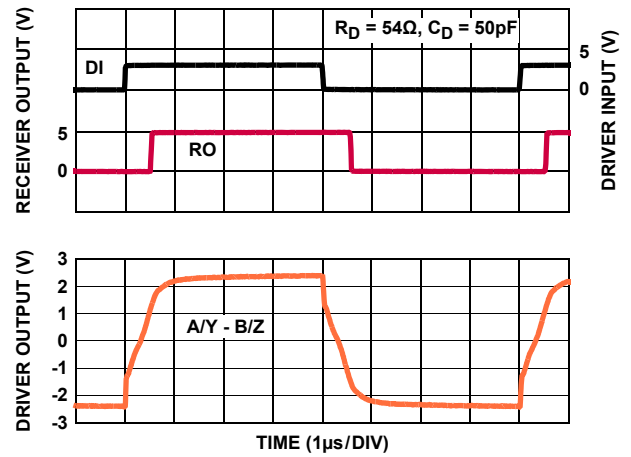

FIGURE 26. DRIVER AND RECEIVER WAVEFORMS (ISL32470E, ISL32472E)

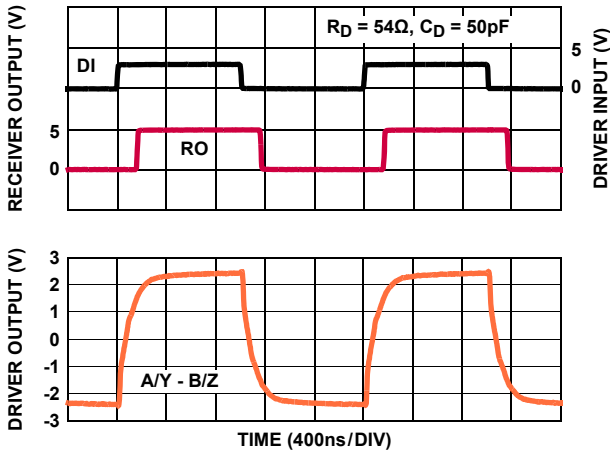

FIGURE 27. DRIVER AND RECEIVER WAVEFORMS (ISL32475E)

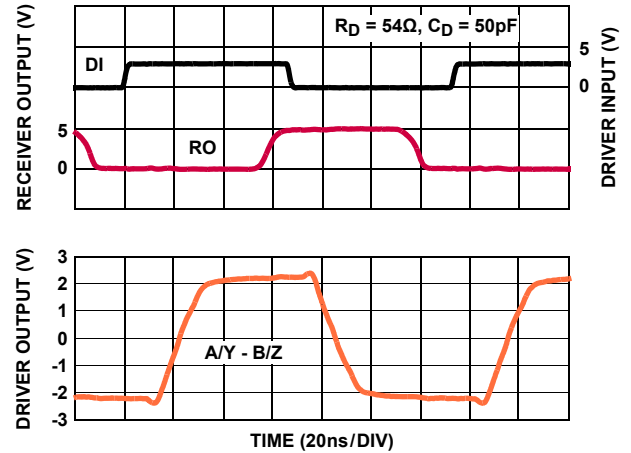

FIGURE 28. DRIVER AND RECEIVER WAVEFORMS (ISL32478E)

Application Information

RS-485 and RS-422 are differential (balanced) data transmission standards used for long haul or noisy environments. RS-422 is a subset of RS-485, so RS-485 transceivers are also RS-422 compliant. RS-422 is a point-to-multipoint (multidrop) standard that allows only one driver and up to 10 (assuming one-unit load devices) receivers on each bus. RS-485 is a true multipoint standard that allows up to 32 one-unit load devices (any combination of drivers and receivers) on each bus. To allow for multipoint operation, the RS-485 specification requires that drivers must handle bus contention without sustaining any damage.

An important advantage of RS-485 is the extended Common-Mode Range (CMR), which specifies that the driver outputs and receiver inputs withstand signals that range from +12V to -7V. RS-422 and RS-485 are intended for runs as long as 4000ft; thus, the wide CMR is necessary to handle ground potential differences and voltages induced in the cable by external fields.

The ISL3247xE devices are a family of ruggedized RS-485 transceivers that improves on the RS-485 basic requirements and increases system reliability. The CMR increases to $\pm 15\text{V}$ and the RS-485 bus pins (receiver inputs and driver outputs) include fault protection against voltages and transients up to $\pm 60\text{V}$. Additionally, larger-than-required differential output voltages (V_{OD}) increase noise immunity, and the $\pm 16.5\text{kV}$ built-in ESD protection complements the fault protection.

Receiver (Rx) Features

These devices use a differential input receiver for maximum noise immunity and common-mode rejection. Input sensitivity is better than $\pm 200\text{mV}$, as required by the RS-422 and RS-485 specifications.

The receiver input (load) current surpasses the RS-422 specification of 3mA and is four times lower than the RS-485 Unit Load (UL) requirement of 1mA maximum. Therefore, these products are known as one-quarter UL transceivers, and there can be up to 128 of these devices on a network while still complying with the RS-485 loading specification.

The receivers function with common-mode voltages as great as $\pm 15\text{V}$, making them ideal for industrial or long networks where induced voltages are a realistic concern.

All the receivers include a full fail-safe function that ensures a high-level receiver output if the receiver inputs are unconnected (floating), shorted together, or connected to a terminated bus with all the transmitters disabled (an idle bus).

The receiver outputs feature high drive levels (typically 22mA at $V_{OL} = 1\text{V}$) to ease the design of optically coupled isolated interfaces.

The receivers easily meet the data rates supported by the corresponding driver, and all receiver outputs are three-statable using the active low $\overline{\text{RE}}$ input.

The receivers in the 250kbps versions (ISL32470E and ISL32472E) and 1Mbps versions (ISL32475E) include noise filtering circuitry to reject high-frequency signals. The ISL32475E

version typically rejects pulses narrower than 50ns (equivalent to 20Mbps). The ISL32470E and ISL32472E reject pulses below 150ns (6.7Mbps).

Driver (Tx) Features

The RS-485/RS-422 driver is a differential output device that delivers at least 1.5V across a 54 Ω load (RS-485) and at least 2.4V across a 100 Ω load (RS-422). The drivers feature low propagation delay skew to maximize bit width and to minimize EMI, and all drivers are three-statable using the active high DE input.

The 250kbps and 1Mbps driver outputs are slew rate limited to minimize EMI and reflections in unterminated or improperly terminated networks. The ISL32478E driver outputs are not limited, so faster output transition times allow data rates of at least 15Mbps.

High Overvoltage (Fault) Protection Increases Ruggedness

The $\pm 60\text{V}$ fault protection (referenced to the IC GND) on the RS-485 pins makes these transceivers some of the most rugged on the market. This level of protection makes the ISL3247xE perfect for applications where power (for example 24V and 48V supplies) must be routed in the conduit with the data lines, or for outdoor applications where large transients are likely to occur. When power is routed with the data lines, even a momentary short between the supply and data lines destroys an unprotected device. The $\pm 60\text{V}$ fault levels of this family are at least five times higher than the levels specified for standard RS-485 ICs. The ISL3247xE protection is active whether the Tx is enabled or disabled, and even if the IC is powered down or if VCC and Ground are floating.

If transients or voltages (including overshoots and ringing) greater than $\pm 60\text{V}$ are possible, additional external protection is required.

Wide Common-Mode Voltage (CMV) Tolerance Improves Operating Range

RS-485 networks operating in industrial complexes or over long distances are susceptible to large CMV variations. Either of these operating environments can suffer from large node-to-node ground potential differences or CMV pickup from external electromagnetic sources, and devices with only the minimum required +12V to -7V CMR can malfunction. The ISL3247xE's extended $\pm 15\text{V}$ CMR allows for operation in environments that would overwhelm lesser transceivers. Additionally, the Rx does not phase invert (erroneously change state), even with CMVs of $\pm 40\text{V}$ or differential voltages as large as 40V.

High V_{OD} Improves Noise Immunity and Flexibility

The ISL3247xE driver design delivers larger differential output voltages (V_{OD}) than the RS-485 standard requires or than most RS-485 transmitters can deliver. The typical $\pm 2.5\text{V}$ V_{OD} provides more noise immunity than networks built using many other transceivers.

Another advantage of the large V_{OD} is the ability to drive more than two bus terminations, which allows use of the ISL3247xE in star topologies and other multi-terminated, nonstandard network topologies. [Figure 11 on page 11](#) details the transmitter's V_{OD} vs I_{OUT} characteristic and includes load lines for four (30 Ω) and six (20 Ω) 120 Ω terminations. [Figure 11](#) shows that the driver typically delivers $\pm 1.3V$ into six terminations, and the [“Electrical Specifications”](#) ensure a V_{OD} of $\pm 0.8V$ at 21 Ω across the full temperature range. The RS-485 standard requires a minimum 1.5V V_{OD} into two terminations, but the ISL3247xE delivers RS-485 voltage levels with two to three times the number of terminations.

Hot Plug Function

When a piece of equipment powers up, there is a period of time when the processor or ASIC driving the RS-485 control lines (DE, RE) is unable to ensure that the RS-485 Tx and Rx outputs are kept disabled. If the equipment is connected to the bus, a driver activating prematurely during power-up can crash the bus. To avoid crashes, the ISL3247xE devices incorporate a hot plug function. Circuitry monitoring V_{CC} ensures that, the Tx and Rx outputs remain disabled during power-up and power-down if V_{CC} is less than $\approx 3.5V$, regardless of the state of DE and RE. The disabled Tx and Rx outputs allow the processor/ASIC to stabilize and drive the RS-485 control lines to the proper states. [Figure 29](#) illustrates the power-up and power-down performance of the ISL3247xE compared to an RS-485 IC without the hot plug feature.

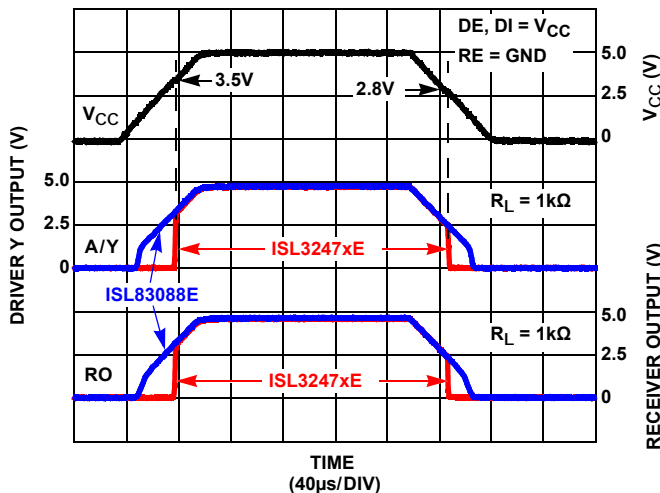

FIGURE 29. HOT PLUG PERFORMANCE (ISL3247xE) vs ISL83088E WITHOUT HOT PLUG CIRCUITRY

ESD Protection

All pins on these devices include Class 3 (>8kV) Human Body Model (HBM) ESD protection structures that can survive ESD events commonly seen during manufacturing. Even so, the RS-485 pins (driver outputs and receiver inputs) incorporate more advanced structures that allow them to survive ESD events in excess of $\pm 16.5kV$ HBM ($\pm 15kV$ for the full-duplex versions). The RS-485 pins are particularly vulnerable to ESD strikes because they typically connect to an exposed port on the exterior of the finished product. Touching the port pins or

connecting a cable can cause an ESD event that destroys unprotected ICs. The new ESD structures protect the device whether or not it is powered up, and without interfering with the exceptional $\pm 15V$ CMR. The built-in ESD protection minimizes the need for board-level protection structures (such as transient suppression diodes) and the associated undesirable capacitive load they present.

Data Rate, Cables, and Terminations

RS-485/RS-422 are intended for network lengths up to 4000ft, but the maximum system data rate decreases as the transmission length increases. The ISL32478E operating at 15Mbps can be used at lengths up to 150ft (46m), but the distance can be increased to 328ft (100m) by operating at 10Mbps. The ISL32475E can operate at full data rates (1Mbps) with lengths up to 800ft (244m). Jitter is the limiting parameter at these faster data rates, so using encoded data streams (for example, Manchester coded or Return-to-Zero) can allow increased transmission distances. The ISL32470E and ISL32472E can operate at 115kbps or less at the full 4000ft (1220m) distance, or at the full data rate of 250kbps for lengths up to 3000ft (915m). DC cable attenuation is the limiting parameter, so using better-quality cables such as 22 AWG can allow increased transmission distance.

Use twisted pair cables for RS-485/RS-422 networks. Twisted-pair cables tend to pick up noise and other electromagnetically induced voltages as common-mode signals that are effectively rejected by the differential receivers in these ICs.

Note: Proper termination is imperative to minimize reflections when using the ISL32478E. Short networks using the ISL32470E and ISL32472E do not need to be terminated; however, terminations are recommended unless power dissipation is an overriding concern.

In point-to-point or point-to-multipoint networks (single driver on the bus like RS-422), terminate the main cable in its characteristic impedance (typically 120 Ω) at the end farthest from the driver. In multi-receiver applications, keep stubs connecting receivers to the main cable as short as possible. Multipoint (multi-driver) systems require the main cable to terminate in its characteristic impedance at both ends. Stubs connecting a transceiver to the main cable should be as short as possible.

Built-In Driver Overload Protection

The RS-485 specification requires that drivers survive worst-case bus contentions undamaged. These transceivers meet this requirement through driver output short-circuit current limits and on-chip thermal shutdown circuitry.

The driver output stages incorporate a double foldback short-circuit current limiting scheme that ensures that the output current never exceeds the RS-485 specification, even at the common-mode and fault condition voltage range extremes. The first foldback current level ($\approx 70mA$) is set to ensure that the driver never folds back when driving loads with common-mode voltages up to $\pm 15V$. The very low second foldback current setting ($\approx 9mA$) minimizes power dissipation if the Tx is enabled when a fault occurs.

In the event of a major short-circuit condition, the ISL3247xE thermal shutdown feature disables the drivers whenever the die temperature becomes excessive. Thermal shutdown eliminates the power dissipation, allowing the die to cool. The drivers automatically re-enable after the die temperature drops by about 15°C. If the contention persists, the thermal shutdown/re-enable cycle repeats until the fault is cleared. The receivers stay operational during thermal shutdown.

Low Power Shutdown Mode

These BiCMOS transceivers all use a fraction of the power required by competitive devices, but they also include a

shutdown feature that reduces the already low quiescent I_{CC} to a 10µA trickle. These devices enter shutdown whenever the receiver and driver are simultaneously disabled ($\overline{RE} = V_{CC}$ and $DE = GND$) for a period of at least 600ns. Disabling both the driver and the receiver for less than 60ns ensures that the transceiver does not enter shutdown.

Note: The receiver and driver enable times increase when the transceiver enables from shutdown. See [Notes 11](#) through [15](#) for more information.

Die Characteristics

SUBSTRATE POTENTIAL (POWERED UP):

GND

PROCESS:

Si Gate BiCMOS

Revision History The revision history provided is for informational purposes only and is believed to be accurate, but not warranted. Visit our website to make sure you have the latest revision.

DATE	REVISION	CHANGE
Feb 14, 2019	FN7784.2	Added Related Literature section to page 1. Added tape and reel information and updated notes in ordering information table on page 3. Updated "High Overvoltage (Fault) Protection Increases Ruggedness" section on page 15. Removed Products section. Updated disclaimer.
Mar 9, 2012	FN7784.1	Page 5 - Thermal Information, Thermal Resistance: 8 Ld SOIC Package Theta JA changed from 116 to 108 Page 14 - Updated Figure 15 to show Pos breakdown between 60V and 70V. Page 19 - Updated Package Outline Drawing M8.15 to newest revision.
Jan 21, 2011	FN7784.0	Initial Release

Package Outline Drawings

For the most recent package outline drawing, see [M14.15](#).

M14.15

14 LEAD NARROW BODY SMALL OUTLINE PLASTIC PACKAGE

Rev 1, 10/09

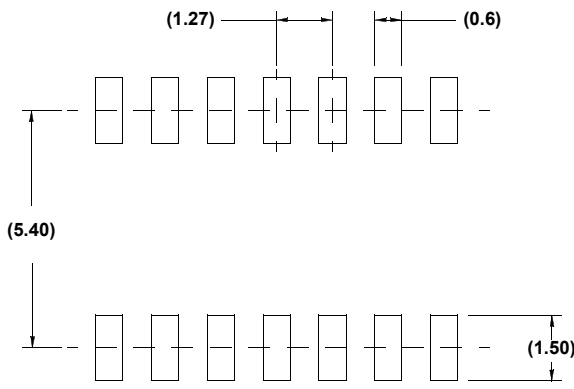
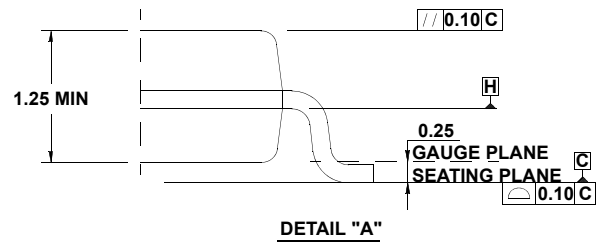
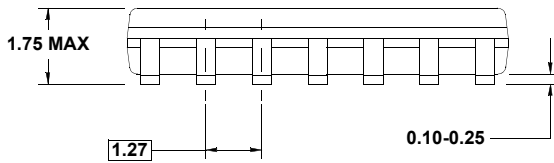
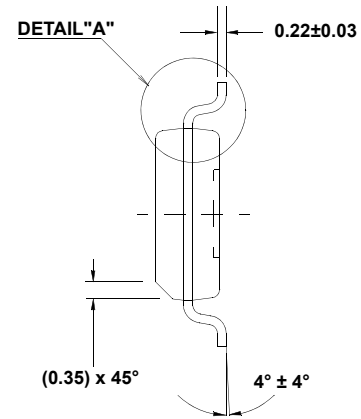
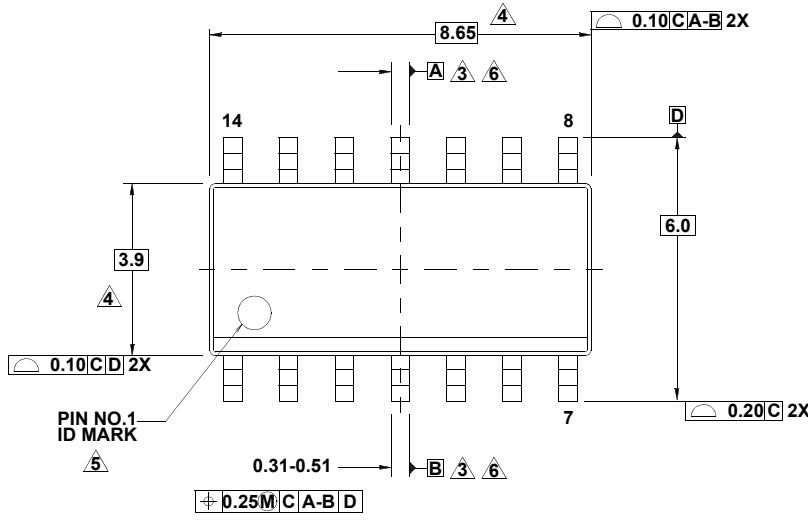

NOTES:

1. Dimensions are in millimeters.
Dimensions in () for Reference Only.
2. Dimensioning and tolerancing conform to AMSEY14.5m-1994.
3. Datums A and B to be determined at Datum H.
4. Dimension does not include interlead flash or protrusions.
Interlead flash or protrusions shall not exceed 0.25mm per side.
5. The pin #1 identifier may be either a mold or mark feature.
6. Does not include dambar protrusion. Allowable dambar protrusion shall be 0.10mm total in excess of lead width at maximum condition.
7. Reference to JEDEC MS-012-AB.

M8.15

8 LEAD NARROW BODY SMALL OUTLINE PLASTIC PACKAGE

Rev 4, 1/12

For the most recent package outline drawing, see [M8.15](#).

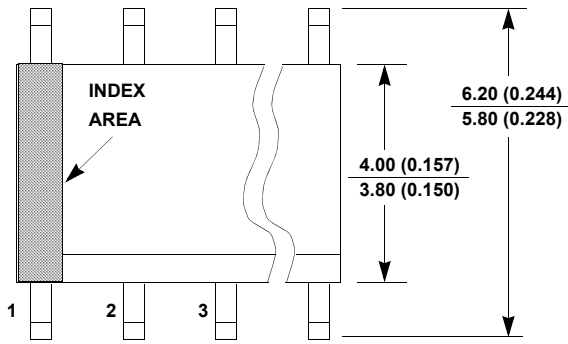

TOP VIEW

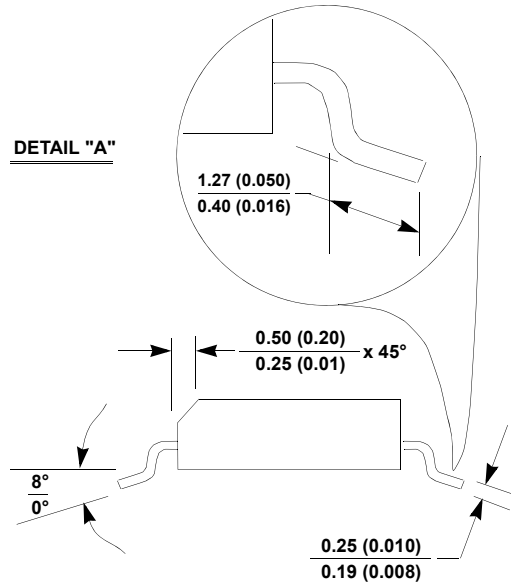

SIDE VIEW "B"

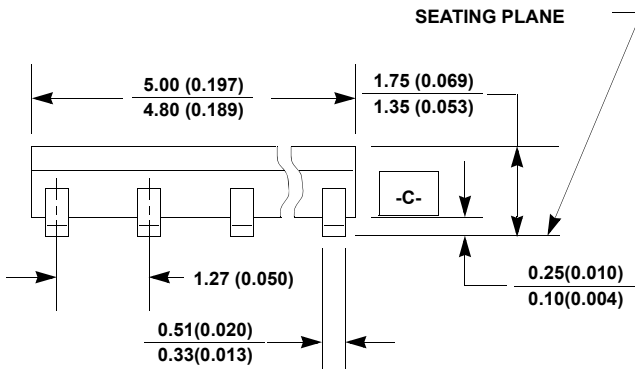

SIDE VIEW "A"

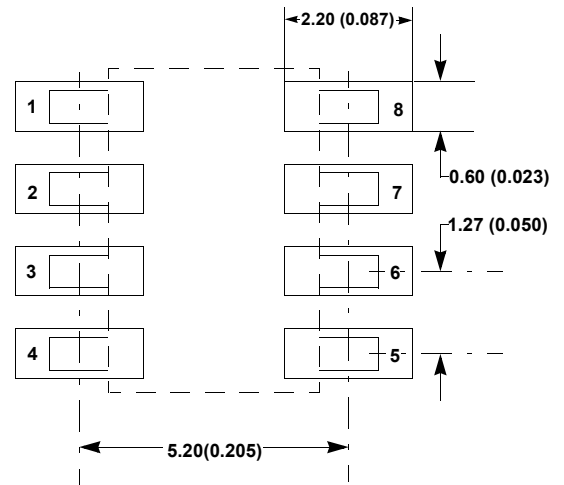

TYPICAL RECOMMENDED LAND PATTERN

NOTES:

1. Dimensioning and tolerancing per ANSI Y14.5M-1994.
2. Package length does not include mold flash, protrusions or gate burrs. Mold flash, protrusion and gate burrs shall not exceed 0.15mm (0.006 inch) per side.
3. Package width does not include interlead flash or protrusions. Interlead flash and protrusions shall not exceed 0.25mm (0.010 inch) per side.
4. The chamfer on the body is optional. If it is not present, a visual index feature must be located within the crosshatched area.
5. Terminal numbers are shown for reference only.
6. The lead width as measured 0.36mm (0.014 inch) or greater above the seating plane, shall not exceed a maximum value of 0.61mm (0.024 inch).
7. Controlling dimension: MILLIMETER. Converted inch dimensions are not necessarily exact.
8. This outline conforms to JEDEC publication MS-012-AA ISSUE C.

Notice

1. Descriptions of circuits, software and other related information in this document are provided only to illustrate the operation of semiconductor products and application examples. You are fully responsible for the incorporation or any other use of the circuits, software, and information in the design of your product or system. Renesas Electronics disclaims any and all liability for any losses and damages incurred by you or third parties arising from the use of these circuits, software, or information.
2. Renesas Electronics hereby expressly disclaims any warranties against and liability for infringement or any other claims involving patents, copyrights, or other intellectual property rights of third parties, by or arising from the use of Renesas Electronics products or technical information described in this document, including but not limited to, the product data, drawings, charts, programs, algorithms, and application examples.
3. No license, express, implied or otherwise, is granted hereby under any patents, copyrights or other intellectual property rights of Renesas Electronics or others.
4. You shall not alter, modify, copy, or reverse engineer any Renesas Electronics product, whether in whole or in part. Renesas Electronics disclaims any and all liability for any losses or damages incurred by you or third parties arising from such alteration, modification, copying or reverse engineering.
5. Renesas Electronics products are classified according to the following two quality grades: "Standard" and "High Quality". The intended applications for each Renesas Electronics product depends on the product's quality grade, as indicated below.
 - "Standard": Computers; office equipment; communications equipment; test and measurement equipment; audio and visual equipment; home electronic appliances; machine tools; personal electronic equipment; industrial robots; etc.
 - "High Quality": Transportation equipment (automobiles, trains, ships, etc.); traffic control (traffic lights); large-scale communication equipment; key financial terminal systems; safety control equipment; etc.Unless expressly designated as a high reliability product or a product for harsh environments in a Renesas Electronics data sheet or other Renesas Electronics document, Renesas Electronics products are not intended or authorized for use in products or systems that may pose a direct threat to human life or bodily injury (artificial life support devices or systems; surgical implantations; etc.), or may cause serious property damage (space system; undersea repeaters; nuclear power control systems; aircraft control systems; key plant systems; military equipment; etc.). Renesas Electronics disclaims any and all liability for any damages or losses incurred by you or any third parties arising from the use of any Renesas Electronics product that is inconsistent with any Renesas Electronics data sheet, user's manual or other Renesas Electronics document.
6. When using Renesas Electronics products, refer to the latest product information (data sheets, user's manuals, application notes, "General Notes for Handling and Using Semiconductor Devices" in the reliability handbook, etc.), and ensure that usage conditions are within the ranges specified by Renesas Electronics with respect to maximum ratings, operating power supply voltage range, heat dissipation characteristics, installation, etc. Renesas Electronics disclaims any and all liability for any malfunctions, failure or accident arising out of the use of Renesas Electronics products outside of such specified ranges.
7. Although Renesas Electronics endeavors to improve the quality and reliability of Renesas Electronics products, semiconductor products have specific characteristics, such as the occurrence of failure at a certain rate and malfunctions under certain use conditions. Unless designated as a high reliability product or a product for harsh environments in a Renesas Electronics data sheet or other Renesas Electronics document, Renesas Electronics products are not subject to radiation resistance design. You are responsible for implementing safety measures to guard against the possibility of bodily injury, injury or damage caused by fire, and/or danger to the public in the event of a failure or malfunction of Renesas Electronics products, such as safety design for hardware and software, including but not limited to redundancy, fire control and malfunction prevention, appropriate treatment for aging degradation or any other appropriate measures. Because the evaluation of microcomputer software alone is very difficult and impractical, you are responsible for evaluating the safety of the final products or systems manufactured by you.
8. Please contact a Renesas Electronics sales office for details as to environmental matters such as the environmental compatibility of each Renesas Electronics product. You are responsible for carefully and sufficiently investigating applicable laws and regulations that regulate the inclusion or use of controlled substances, including without limitation, the EU RoHS Directive, and using Renesas Electronics products in compliance with all these applicable laws and regulations. Renesas Electronics disclaims any and all liability for damages or losses occurring as a result of your noncompliance with applicable laws and regulations.
9. Renesas Electronics products and technologies shall not be used for or incorporated into any products or systems whose manufacture, use, or sale is prohibited under any applicable domestic or foreign laws or regulations. You shall comply with any applicable export control laws and regulations promulgated and administered by the governments of any countries asserting jurisdiction over the parties or transactions.
10. It is the responsibility of the buyer or distributor of Renesas Electronics products, or any other party who distributes, disposes of, or otherwise sells or transfers the product to a third party, to notify such third party in advance of the contents and conditions set forth in this document.
11. This document shall not be reprinted, reproduced or duplicated in any form, in whole or in part, without prior written consent of Renesas Electronics.
12. Please contact a Renesas Electronics sales office if you have any questions regarding the information contained in this document or Renesas Electronics products.

(Note1) "Renesas Electronics" as used in this document means Renesas Electronics Corporation and also includes its directly or indirectly controlled subsidiaries.

(Note2) "Renesas Electronics product(s)" means any product developed or manufactured by or for Renesas Electronics.

(Rev.4.0-1 November 2017)

Corporate Headquarters

TOYOSU FORESIA, 3-2-24 Toyosu,
Koto-ku, Tokyo 135-0061, Japan
www.renesas.com

Contact Information

For further information on a product,
technology, the most up-to-date version of a
document, or your nearest sales office,
please visit:

www.renesas.com/contact/

Trademarks



Renesas and the Renesas logo are
trademarks of Renesas Electronics
Corporation. All trademarks and registered
trademarks are the property of their
respective owners.

Looking for pricing, stock, or lifecycle information?

Click below to explore more details on WIN SOURCE:

-  [View ISL32478EIBZ-T7A on WIN SOURCE](#)
-  [Renesas Electronics America](#) Information

Optimize Your Supply Chain with WIN SOURCE Solutions

-  Global Sourcing Solution
-  Obsolete Management
-  Cost Control Management
-  Shortage Management
-  Alternative Solution
-  Excess Inventory Management