



**THE DATASHEET OF  
ISL28258FBZ**



ISL28158, ISL28258

Micro-power Single and Dual Precision Rail-to-Rail Input-Output (RRIO) Low Input Bias Current Op Amps

FN6377  
Rev 5.00  
October 12, 2015

The ISL28158 and ISL28258 are micro-power precision operational amplifiers optimized for single supply operation at 5.5V and can operate down to 2.4V.

These devices feature an Input Range Enhancement Circuit (IREC), which enables them to maintain CMRR performance for input voltages greater than the positive supply. The input signal is capable of swinging 0.25V above the positive supply and to 100mV below the negative supply with only a slight degradation of the CMRR performance. The output operation is rail-to-rail.

The ISL28158 and ISL28258 draw minimal supply current while meeting excellent DC-accuracy noise and output drive specifications. Competing devices seriously degrade these parameters to achieve micro-power supply current. Offset current, voltage and current noise, slew rate, and gain bandwidth product are all two to ten times better than on previous micro-power op amps.

The 1/f corner of the voltage noise spectrum is at 100Hz. This results in low frequency noise performance, which can only be found on devices with an order of magnitude higher supply current.

ISL28158 and ISL28258 can be operated from one lithium cell or two Ni-Cd batteries. The input range includes both positive and negative rail. The output swings to both rails.

**Features**

- 34µA typical supply current (ISL28158)
- 68µA typical supply current (ISL28258)
- 300µV maximum offset voltage (8 Ld SOIC)
- 1pA typical input bias current
- 200kHz gain bandwidth product
- 2.4V to 5.5V single supply voltage range
- Rail-to-rail input and output
- Enable pin (ISL28158 only)
- Pb-free (RoHS compliant)

**Applications**

- Battery- or solar-powered systems
- 4mA to 20mA current loops
- Handheld consumer products
- Medical devices
- Sensor amplifiers
- ADC buffers
- DAC output amplifiers

**Pinouts**

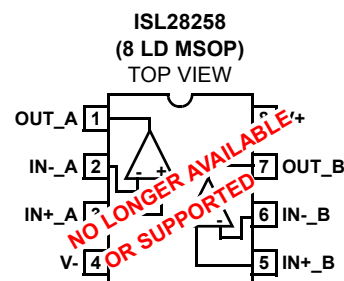
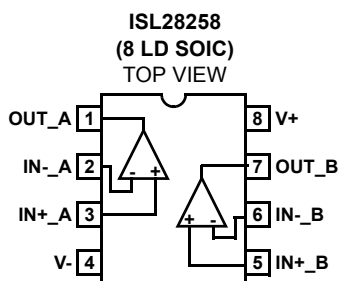
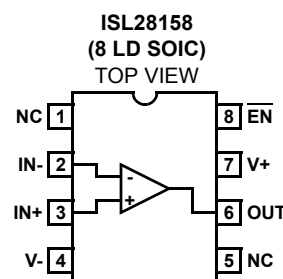
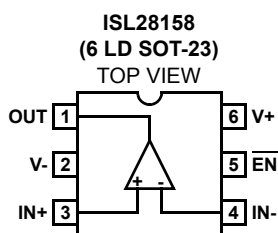

## Ordering Information

| PART NUMBER<br>(Note 2)  | PART<br>MARKING  | PACKAGE<br>(Pb-free) | PKG.<br>DWG. # |
|--|------------------|----------------------|----------------|
| ISL28158FHZ-T7 (Note 1)  | GABW (Note 3)    | 6 Ld SOT-23          | P6.064A        |
| ISL28158FHZ-T7A (Note 1)   | GABW (Note 3)    | 6 Ld SOT-23          | P6.064A        |
| ISL28158FBZ  | 28158 FBZ        | 8 Ld SOIC            | M8.15E         |
| ISL28158FBZ-T7 (Note 1)  | 28158 FBZ        | 8 Ld SOIC            | M8.15E         |
| ISL28258FBZ (No longer available,<br>recommended replacement: ISL28158FBZ-T7)                | 28258 FBZ        | 8 Ld SOIC            | M8.15E         |
| ISL28258FBZ-T7 (Note 1)<br>(No longer available, recommended<br>replacement: ISL28158FBZ-T7) | 28258 FBZ        | 8 Ld SOIC            | M8.15E         |
| ISL28258FUZ (No longer available,<br>recommended replacement: ISL28158FBZ-T7)                | 8258Z            | 8 Ld MSOP            | M8.118A        |
| ISL28258FUZ-T7 (Note 1)<br>(No longer available, recommended<br>replacement: ISL28158FBZ-T7) | 8258Z            | 8 Ld MSOP            | M8.118A        |
| ISL28158EVAL1Z   | Evaluation Board |                      |                |

### NOTES:

1. Please refer to [TB347](#) for details on reel specifications.
2. These Intersil Pb-free plastic packaged products employ special Pb-free material sets, molding compounds/die attach materials, and 100% matte tin plate plus anneal (e3 termination finish, which is RoHS compliant and compatible with both SnPb and Pb-free soldering operations). Intersil Pb-free products are MSL classified at Pb-free peak reflow temperatures that meet or exceed the Pb-free requirements of IPC/JEDEC J STD-020.
3. The part marking is located on the bottom of the part.

**Absolute Maximum Ratings** ( $T_A = +25^\circ\text{C}$ )

|                                  |                      |
|----------------------------------|----------------------|
| Supply Voltage                   | 5.75V                |
| Supply Turn On Voltage Slew Rate | 1V/ $\mu\text{s}$    |
| Differential Input Current       | 5mA                  |
| Differential Input Voltage       | 0.5V                 |
| Input Voltage                    | V- -0.5V to V+ +0.5V |
| ESD Rating                       |                      |
| Human Body Model                 | 3kV                  |
| Machine Model                    | 300V                 |
| Charge Device Model              | 1500V                |

**Thermal Information**

|   |   |
|---|---|
| Thermal Resistance (Typical, Note 4)  | $\theta_{JA}$ ( $^\circ\text{C}/\text{W}$ )   |
| 6 Ld SOT-23 Package   | 230   |
| 8 Ld SOIC Package   | 120   |
| 8 Ld MSOP Package   | 160   |
| Output Short-Circuit Duration   | Indefinite                                    |
| Ambient Operating Temperature Range   | -40 $^\circ\text{C}$ to +125 $^\circ\text{C}$ |
| Storage Temperature Range   | -65 $^\circ\text{C}$ to +150 $^\circ\text{C}$ |
| Operating Junction Temperature  | +125 $^\circ\text{C}$                         |
| <b>Pb-Free Reflow Profile</b> see link below  |   |
| <a href="http://www.intersil.com/pbfree/Pb-FreeReflow.asp">http://www.intersil.com/pbfree/Pb-FreeReflow.asp</a> |   |

**CAUTION:** Do not operate at or near the maximum ratings listed for extended periods of time. Exposure to such conditions may adversely impact product reliability and result in failures not covered by warranty.

**NOTE:**

4.  $q_{JA}$  is measured with the component mounted on a high effective thermal conductivity test board in free air. See Tech Brief [TB379](#) for details.

**IMPORTANT NOTE:** All parameters having Min/Max specifications are guaranteed. Typical values are for information purposes only. Unless otherwise noted, all tests are at the specified temperature and are pulsed tests, therefore:  $T_J = T_C = T_A$

**Electrical Specifications**  $V_+ = 5\text{V}$ ,  $V_- = 0\text{V}$ ,  $V_{CM} = 2.5\text{V}$ ,  $R_L = \text{Open}$ ,  $T_A = +25^\circ\text{C}$  unless otherwise specified.

**Boldface limits apply over the operating temperature range, -40 $^\circ\text{C}$  to +125 $^\circ\text{C}$ .** Temperature data established by characterization.

| PARAMETER                        | DESCRIPTION                         | CONDITIONS   | MIN<br>(Note 5) | TYP     | MAX<br>(Note 5) | UNIT                         |
|----------------------------------|-------------------------------------|--|-----------------|---------|-----------------|------------------------------|
| <b>DC SPECIFICATIONS</b>         |                                     |  |                 |         |                 |                              |
| $V_{OS}$                         | Input Offset Voltage                | 8 Ld SOIC  | -300            | 3.1     | 300             | $\mu\text{V}$                |
|                                  |                                     |  | <b>-650</b>     |         | <b>650</b>      |                              |
|                                  |                                     | 6 Ld SOT-23  | -550            | 5       | 550             | $\mu\text{V}$                |
|                                  |                                     |  | <b>-750</b>     |         | <b>750</b>      |                              |
|                                  |                                     | 8 Ld MSOP  | -350            | 3       | 350             | $\mu\text{V}$                |
|                                  |                                     |  | <b>-700</b>     |         | <b>700</b>      |                              |
| $\frac{\Delta V_{OS}}{\Delta T}$ | Input Offset Voltage vs Temperature |  |                 | 0.3     |                 | $\mu\text{V}/^\circ\text{C}$ |
| $I_{OS}$                         | Input Offset Current                | $T_A = -40^\circ\text{C}$ to +85 $^\circ\text{C}$                  | -35             | $\pm 5$ | 35              | pA                           |
|                                  |                                     |  | <b>-80</b>      |         | <b>80</b>       |                              |
| $I_B$                            | Input Bias Current                  | $T_A = -40^\circ\text{C}$ to +85 $^\circ\text{C}$                  | -30             | $\pm 1$ | 30              | pA                           |
|                                  |                                     |  | <b>-80</b>      |         | <b>80</b>       |                              |
| $V_{CM}$                         | Common-Mode Voltage Range           | Guaranteed by CMRR   | 0               |         | 5               | V                            |
| CMRR                             | Common-Mode Rejection Ratio         | $V_{CM} = 0\text{V}$ to 5V   | 75              | 98      |                 | dB                           |
|                                  |                                     |  | <b>70</b>       |         |                 |                              |
| PSRR                             | Power Supply Rejection Ratio        | $V_+ = 2.4\text{V}$ to 5.5V  | 80              | 98      |                 | dB                           |
|                                  |                                     |  | <b>75</b>       |         |                 |                              |
| $A_{VOL}$                        | Large Signal Voltage Gain           | $V_O = 0.5\text{V}$ to 4.5V, $R_L = 100\text{k}\Omega$ to $V_{CM}$ | 100             | 220     |                 | V/mV                         |
|                                  |                                     |  | <b>75</b>       |         |                 |                              |
|                                  |                                     | $V_O = 0.5\text{V}$ to 4.5V, $R_L = 1\text{k}\Omega$ to $V_{CM}$   |                 | 45      |                 | V/mV                         |

**Electrical Specifications**  $V_+ = 5V$ ,  $V_- = 0V$ ,  $V_{CM} = 2.5V$ ,  $R_L = \text{Open}$ ,  $T_A = +25^\circ\text{C}$  unless otherwise specified.  
**Boldface limits apply over the operating temperature range,  $-40^\circ\text{C}$  to  $+125^\circ\text{C}$ .** Temperature data established by characterization. (Continued)

| PARAMETER                                   | DESCRIPTION  | CONDITIONS   | MIN<br>(Note 5) | TYP        | MAX<br>(Note 5) | UNIT                  |
|---|--|--|-----------------|------------|-----------------|-----------------------|
| $V_{OUT}$                                   | Maximum Output Voltage Swing                         | Output low, $R_L = 100k\Omega$ to $V_{CM}$   |                 | 5.3        | 6               | mV                    |
|   |  |  |                 |            | <b>20</b>       |                       |
|   |  | Output low, $R_L = 1k\Omega$ to $V_{CM}$   |                 | 135        | 150             | mV                    |
|   |  |  |                 |            | <b>250</b>      |                       |
| Output high, $R_L = 100k\Omega$ to $V_{CM}$ |  | 4.992  | 4.996           |            | V               |                       |
|   |  | <b>4.990</b>   |                 |            |                 |                       |
| Output high, $R_L = 1k\Omega$ to $V_{CM}$   |  | 4.84   | 4.874           |            | V               |                       |
|   |  | <b>4.77</b>  |                 |            |                 |                       |
| $I_{S,ON}$                                  | Quiescent Supply Current                             | $V_+ = 5V$ , Enable<br>(ISL28158)  |                 | 34         | 43              | $\mu\text{A}$         |
|   |  |  |                 | <b>55</b>  |                 |                       |
| $I_{S,OFF}$                                 | Quiescent Supply Current, Disabled<br>(ISL28158)     | $V_+ = 5V$<br>(ISL28258)   |                 | 68         | 86              | $\mu\text{A}$         |
|   |  |  |                 | <b>110</b> |                 |                       |
| $I_{S,OFF}$                                 | Quiescent Supply Current, Disabled<br>(ISL28158)     |  |                 | 10         | 14              | $\mu\text{A}$         |
|   |  |  |                 |            | <b>19</b>       |                       |
| $I_{O+}$                                    | Short-Circuit Output Source Current                  | $R_L = 10\Omega$ to $V_{CM}$   |                 | 27         | 30              | mA                    |
|   |  |  |                 | <b>20</b>  |                 |                       |
| $I_{O-}$                                    | Short-Circuit Output Sink Current                    | $R_L = 10\Omega$ to $V_{CM}$   |                 | -25        | -22             | mA                    |
|   |  |  |                 |            | <b>-15</b>      |                       |
| $V_{SUPPLY}$                                | Supply Operating Range                               | $V_+$ to $V_-$   | 2.4             |            | 5.5             | V                     |
| $V_{ENH}$                                   | $\overline{EN}$ Pin High Level (ISL28158)            |  | <b>2</b>        |            |                 | V                     |
| $V_{ENL}$                                   | $\overline{EN}$ Pin Low Level (ISL28158)             |  |                 |            | <b>0.8</b>      | V                     |
| $I_{ENH}$                                   | $\overline{EN}$ Pin Input High Current<br>(ISL28158) | $V_{\overline{EN}} = V_+$  |                 | 1          | 1.5             | $\mu\text{A}$         |
|   |  |  |                 |            | <b>1.6</b>      |                       |
| $I_{ENL}$                                   | $\overline{EN}$ Pin Input Low Current<br>(ISL28158)  | $V_{\overline{EN}} = V_-$  |                 | 12         | 25              | nA                    |
|   |  |  |                 |            | <b>30</b>       |                       |
| <b>AC SPECIFICATONS</b>                     |  |  |                 |            |                 |                       |
| GBW   | Gain Bandwidth Product                               | $A_V = 100$ , $R_F = 100k\Omega$ , $R_G = 1k\Omega$ ,<br>$R_L = 10k\Omega$ to $V_{CM}$               |                 | 200        |                 | kHz                   |
| Unity Gain Bandwidth                        | -3dB Bandwidth                                       | $A_V = 1$ , $R_F = 0\Omega$ , $V_{OUT} = 10mV_{P-P}$   |                 | 420        |                 | kHz                   |
| $e_N$                                       | Input Noise Voltage Peak-to-Peak                     | $f = 0.1\text{Hz}$ to $10\text{Hz}$  |                 | 1.4        |                 | $\mu V_{P-P}$         |
|   | Input Noise Voltage Density                          | $f_O = 1\text{kHz}$  |                 | 64         |                 | $nV/\sqrt{\text{Hz}}$ |
| $i_N$                                       | Input Noise Current Density                          | $f_O = 10\text{kHz}$   |                 | 0.19       |                 | $pA/\sqrt{\text{Hz}}$ |
| CMRR @ 60Hz                                 | Input Common Mode Rejection Ratio                    | $V_{CM} = 1V_{P-P}$ , $R_L = 10k\Omega$ to $V_{CM}$  |                 | -70        |                 | dB                    |
| PSRR+ @ 120Hz                               | Power Supply Rejection Ratio ( $V_+$ )               | $V_+$ , $V_- = \pm 1.2V$ and $\pm 2.5V$ ,<br>$V_{SOURCE} = 1V_{P-P}$ , $R_L = 10k\Omega$ to $V_{CM}$ |                 | -64        |                 | dB                    |
| PSRR- @ 120Hz                               | Power Supply Rejection Ratio ( $V_-$ )               | $V_+$ , $V_- = \pm 1.2V$ and $\pm 2.5V$ ,<br>$V_{SOURCE} = 1V_{P-P}$ , $R_L = 10k\Omega$ to $V_{CM}$ |                 | -85        |                 | dB                    |
| <b>TRANSIENT RESPONSE</b>                   |  |  |                 |            |                 |                       |
| SR  | Slew Rate  |  |                 | 0.1        |                 | $V/\mu\text{s}$       |

**Electrical Specifications**  $V_+ = 5V$ ,  $V_- = 0V$ ,  $V_{CM} = 2.5V$ ,  $R_L = \text{Open}$ ,  $T_A = +25^\circ\text{C}$  unless otherwise specified.  
**Boldface limits apply over the operating temperature range,  $-40^\circ\text{C}$  to  $+125^\circ\text{C}$ .** Temperature data established by characterization. (Continued)

| PARAMETER                    | DESCRIPTION  | CONDITIONS   | MIN<br>(Note 5) | TYP | MAX<br>(Note 5) | UNIT          |
|------------------------------|--|--|-----------------|-----|-----------------|---------------|
| $t_r$ , $t_f$ , Large Signal | Rise Time, 10% to 90% $V_{OUT}$  | $A_V = +2$ , $V_{OUT} = 1V_{P-P}$ , $R_g = R_f = 10k\Omega$<br>$R_L = 10k\Omega$ to $V_{CM}$ |                 | 10  |                 | $\mu\text{s}$ |
|                              | Fall Time, 90% to 10% $V_{OUT}$  | $A_V = +2$ , $V_{OUT} = 1V_{P-P}$ , $R_g = R_f = 10k\Omega$<br>$R_L = 10k\Omega$ to $V_{CM}$ |                 | 9   |                 | $\mu\text{s}$ |
| $t_r$ , $t_f$ , Small Signal | Rise Time, 10% to 90% $V_{OUT}$  | $A_V = +2$ , $V_{OUT} = 10mV_{P-P}$ ,<br>$R_g = R_f = R_L = 10k\Omega$ to $V_{CM}$           |                 | 650 |                 | ns            |
|                              | Fall Time, 90% to 10% $V_{OUT}$  | $A_V = +2$ , $V_{OUT} = 10mV_{P-P}$ ,<br>$R_g = R_f = R_L = 10k\Omega$ to $V_{CM}$           |                 | 640 |                 | ns            |
| $t_{\overline{EN}}$          | Enable to Output Turn-on Delay Time, 10% $\overline{EN}$ to 10% $V_{OUT}$  | $V_{\overline{EN}} = 5V$ to $0V$ , $A_V = +2$ ,<br>$R_g = R_f = R_L = 1k$ to $V_{CM}$        |                 | 15  |                 | $\mu\text{s}$ |
|                              | Enable to Output Turn-off Delay Time, 10% $\overline{EN}$ to 10% $V_{OUT}$ | $V_{\overline{EN}} = 0V$ to $5V$ , $A_V = +2$ ,<br>$R_g = R_f = R_L = 1k$ to $V_{CM}$        |                 | 0.5 |                 | $\mu\text{s}$ |

## NOTE:

- Parameters with MIN and/or MAX limits are 100% tested at  $+25^\circ\text{C}$ , unless otherwise specified. Temperature limits established by characterization and are not production tested.

**Typical Performance Curves**  $V_+ = 5V, V_- = 0V, V_{CM} = 2.5V, R_L = \text{Open}$ .

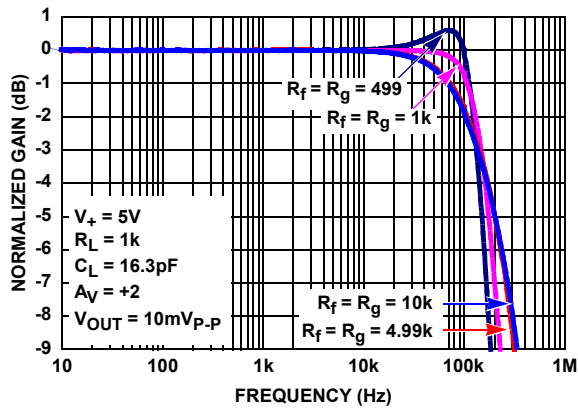

FIGURE 1. GAIN vs FREQUENCY vs FEEDBACK RESISTOR VALUES  $R_f/R_g$

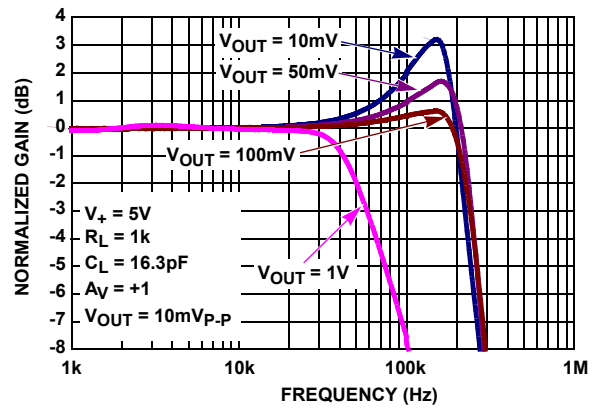

FIGURE 2. GAIN vs FREQUENCY vs  $V_{OUT}$ ,  $R_L = 1k$

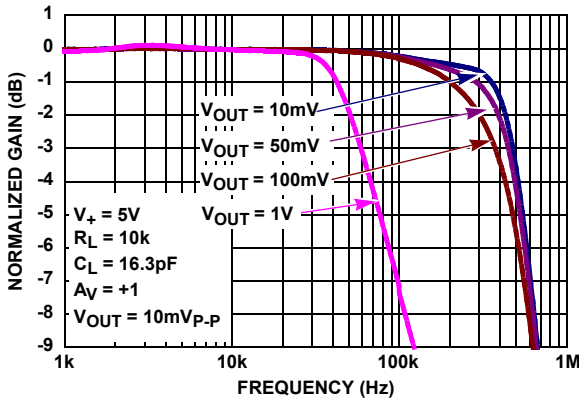

FIGURE 3. GAIN vs FREQUENCY vs  $V_{OUT}$ ,  $R_L = 10k$

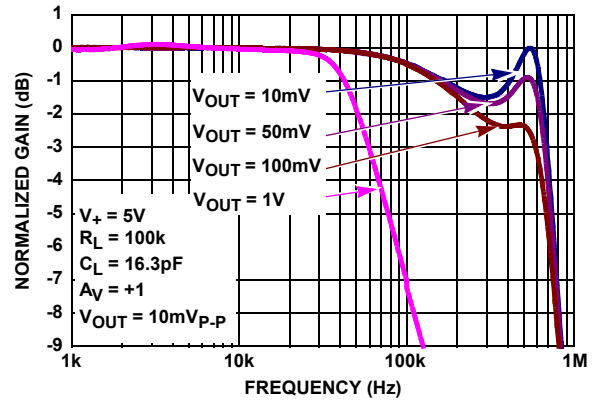

FIGURE 4. GAIN vs FREQUENCY vs  $V_{OUT}$ ,  $R_L = 100k$

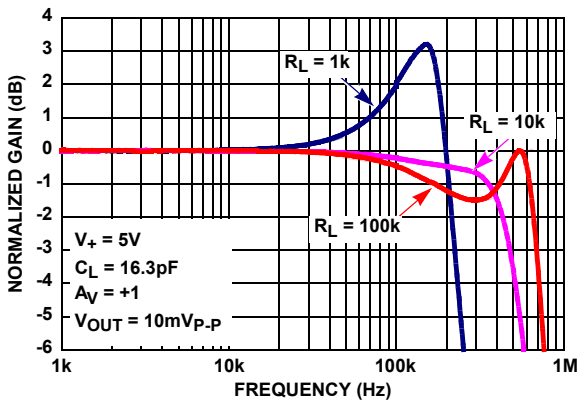

FIGURE 5. GAIN vs FREQUENCY vs  $R_L$

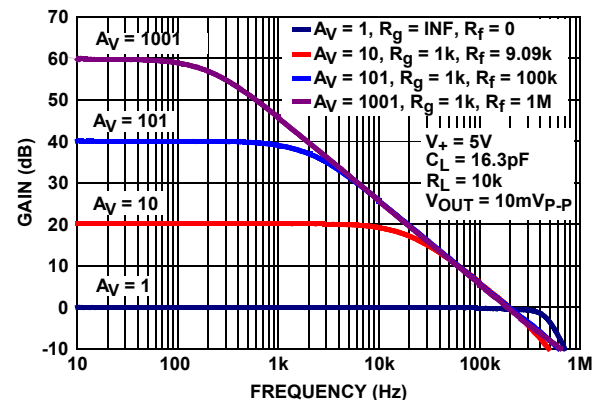

FIGURE 6. FREQUENCY RESPONSE vs CLOSED LOOP GAIN

**Typical Performance Curves**  $V_+ = 5V$ ,  $V_- = 0V$ ,  $V_{CM} = 2.5V$ ,  $R_L = \text{Open}$ . (Continued)

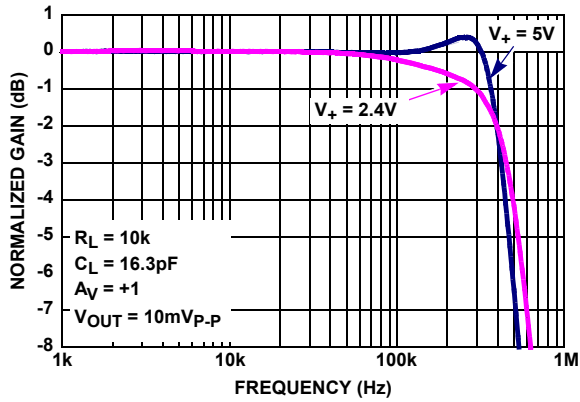

FIGURE 7. GAIN vs FREQUENCY vs SUPPLY VOLTAGE

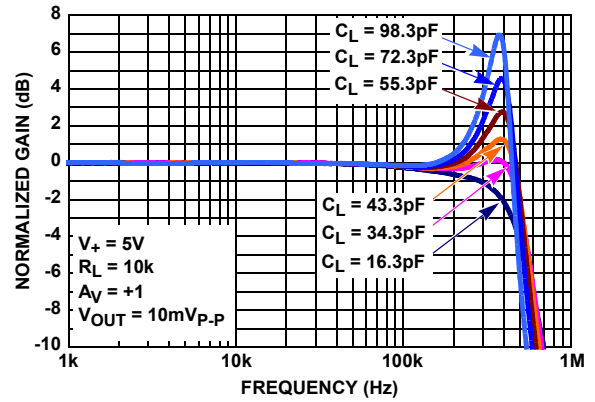

FIGURE 8. GAIN vs FREQUENCY vs  $C_L$

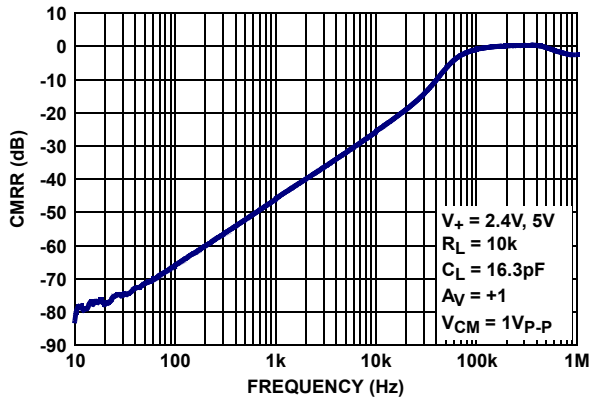

FIGURE 9. CMRR vs FREQUENCY,  $V_+ = 2.4V$  AND  $5V$

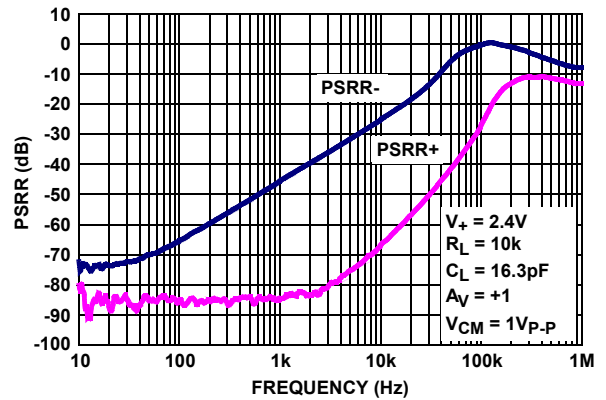

FIGURE 10. PSRR vs FREQUENCY,  $V_+, V_- = \pm 1.2V$

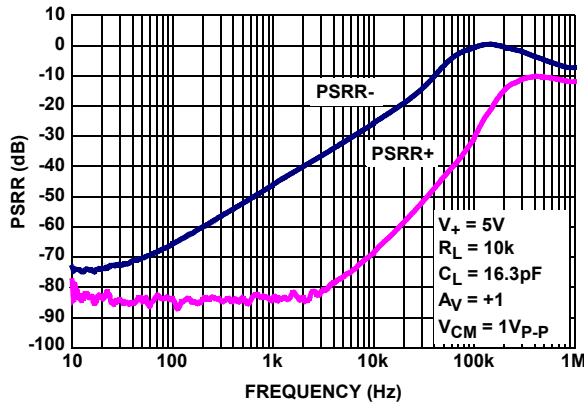

FIGURE 11. PSRR vs FREQUENCY,  $V_+, V_- = \pm 2.5V$

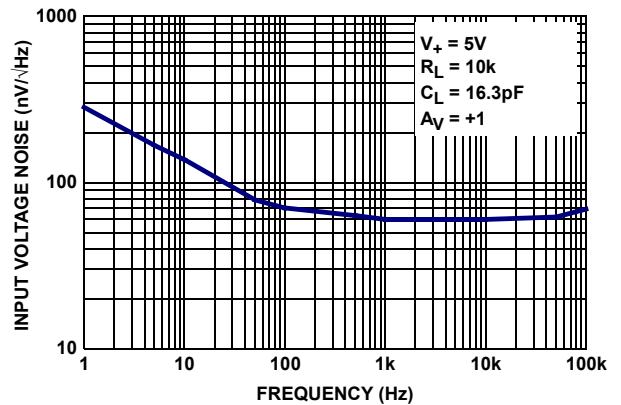

FIGURE 12. INPUT VOLTAGE NOISE DENSITY vs FREQUENCY

**Typical Performance Curves**  $V_+ = 5V, V_- = 0V, V_{CM} = 2.5V, R_L = \text{Open}$ . (Continued)

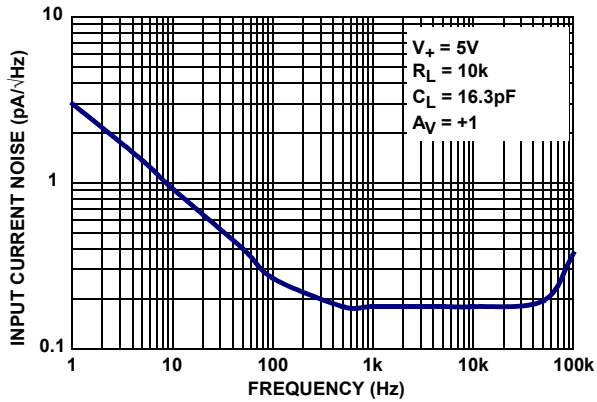

FIGURE 13. INPUT CURRENT NOISE DENSITY vs FREQUENCY

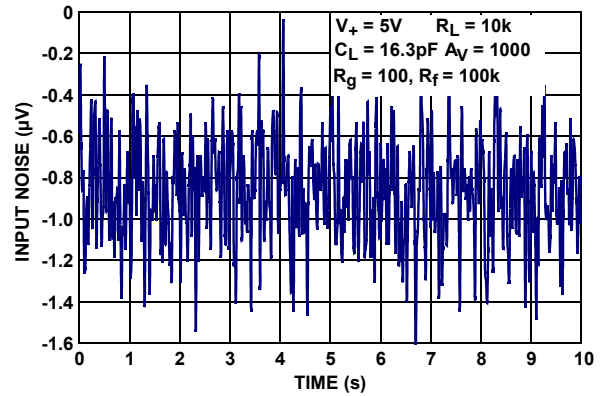

FIGURE 14. INPUT VOLTAGE NOISE 0.1Hz TO 10Hz

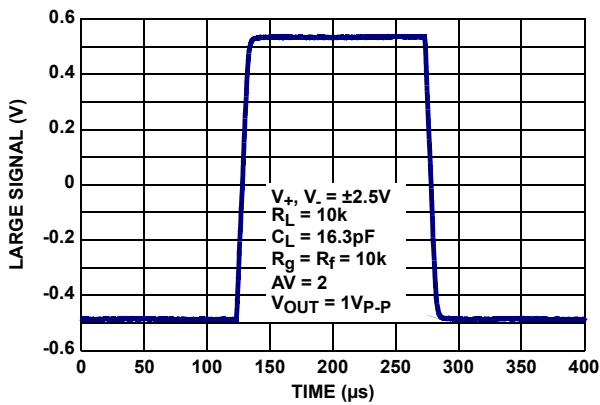

FIGURE 15. LARGE SIGNAL STEP RESPONSE

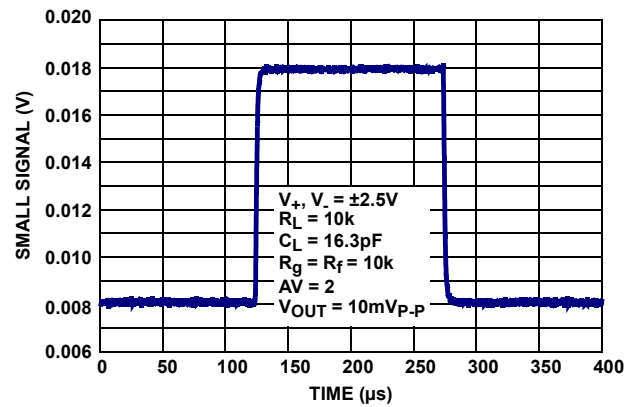

FIGURE 16. SMALL SIGNAL STEP RESPONSE

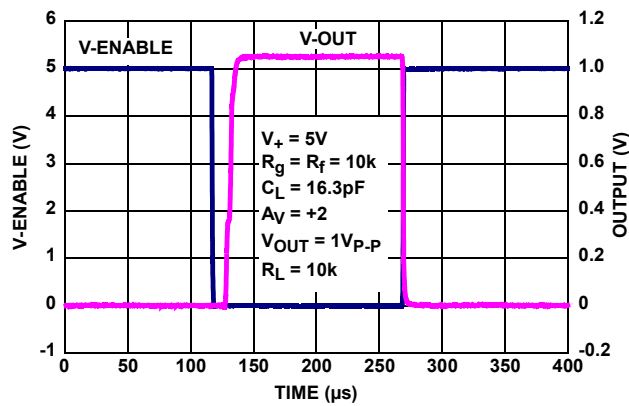

FIGURE 17. ENABLE TO OUTPUT RESPONSE

**Typical Performance Curves**  $V_+ = 5V, V_- = 0V, V_{CM} = 2.5V, R_L = \text{Open}$ . (Continued)

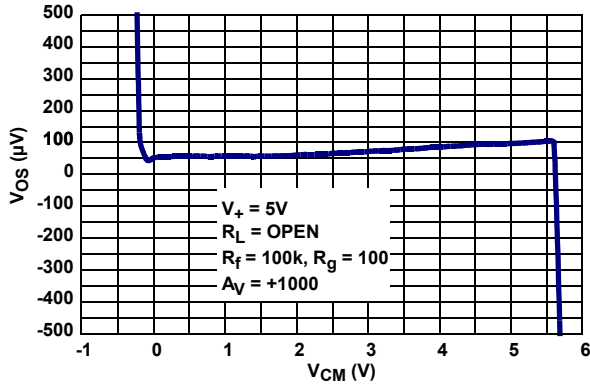

FIGURE 18. INPUT OFFSET VOLTAGE vs COMMON MODE INPUT VOLTAGE

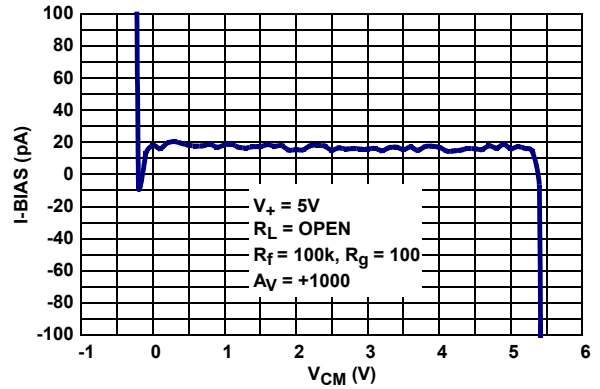

FIGURE 19. INPUT BIAS CURRENT vs COMMON MODE INPUT VOLTAGE

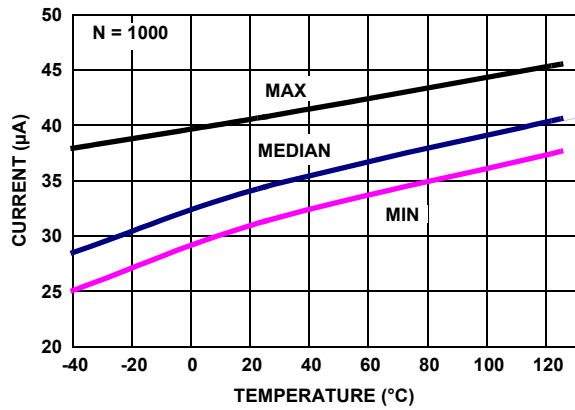

FIGURE 20. SUPPLY CURRENT ENABLED (SINGLE) vs TEMPERATURE,  $V_+, V_- = \pm 2.5V$

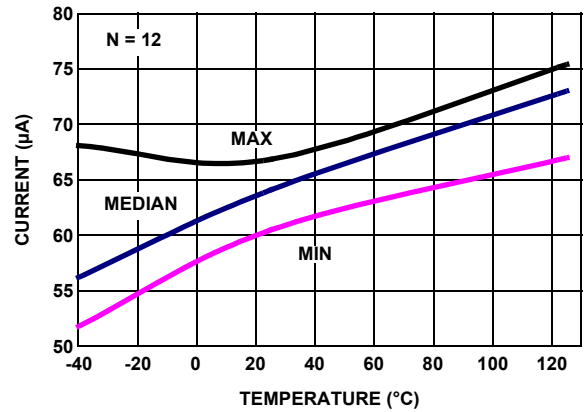

FIGURE 21. SUPPLY CURRENT (DUAL) vs TEMPERATURE,  $V_+, V_- = \pm 2.5V$

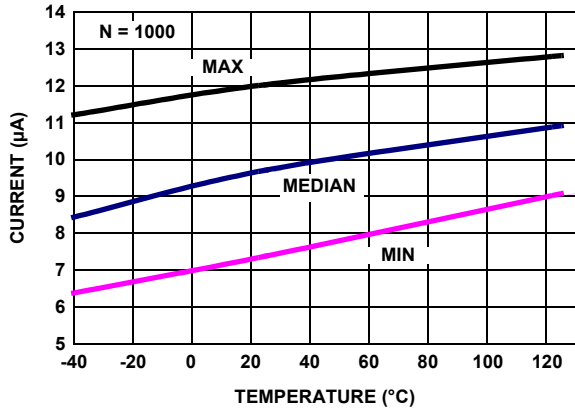

FIGURE 22. SUPPLY CURRENT DISABLED (SINGLE) vs TEMPERATURE,  $V_+, V_- = \pm 2.5V$

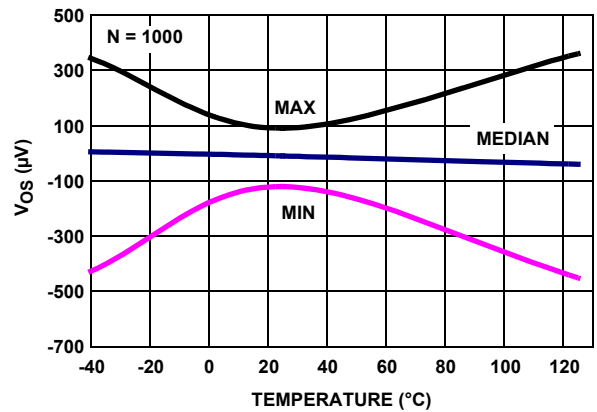

FIGURE 23.  $V_{OS}$  (SOIC PKG) vs TEMPERATURE,  $V_{IN} = 0V, V_+, V_- = \pm 2.75V$

**Typical Performance Curves**  $V_+ = 5V, V_- = 0V, V_{CM} = 2.5V, R_L = \text{Open}$ . (Continued)

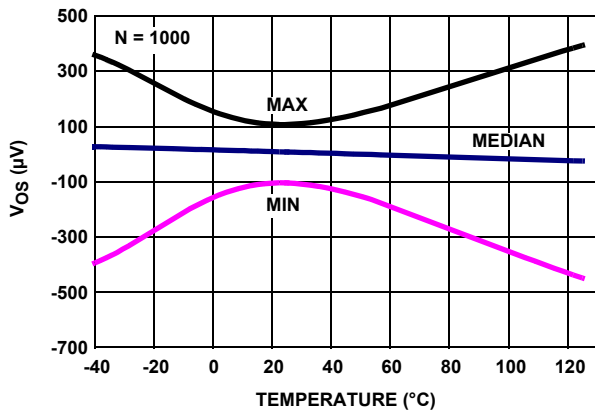

FIGURE 24.  $V_{OS}$  (SOIC PKG) vs TEMPERATURE,  $V_{IN} = 0V, V_+, V_- = \pm 2.5V$

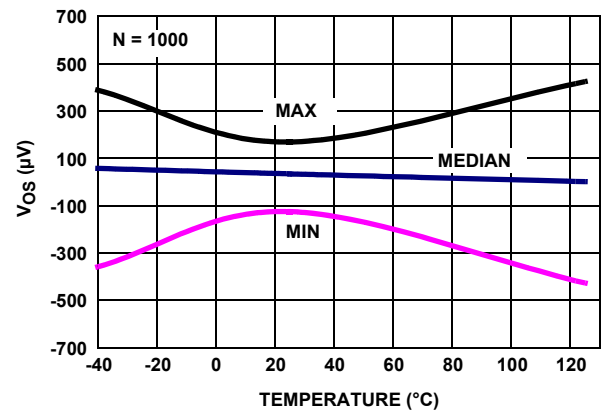

FIGURE 25.  $V_{OS}$  (SOIC PKG) vs TEMPERATURE,  $V_{IN} = 0V, V_+, V_- = \pm 1.2V$

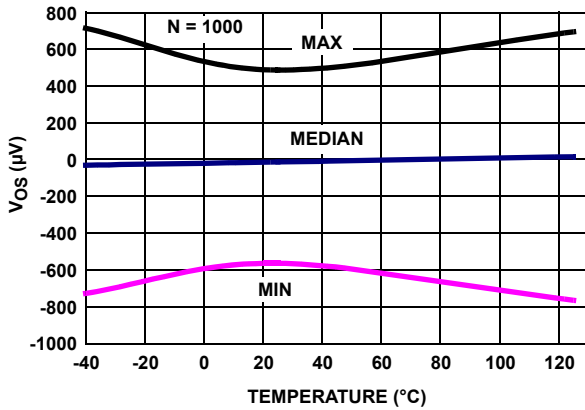

FIGURE 26.  $V_{OS}$  (SOT PKG) vs TEMPERATURE,  $V_{IN} = 0V, V_+, V_- = \pm 2.75V$

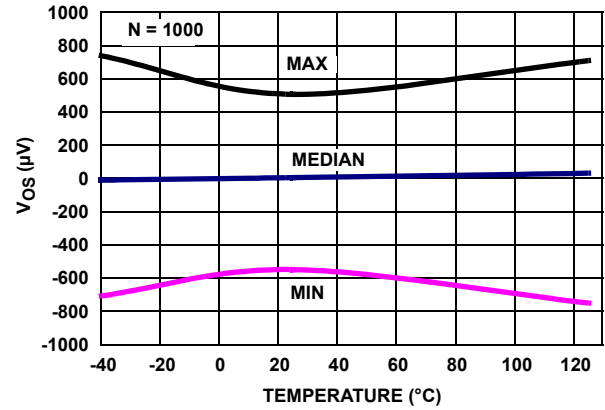

FIGURE 27.  $V_{OS}$  (SOT PKG) vs TEMPERATURE,  $V_{IN} = 0V, V_+, V_- = \pm 2.5V$

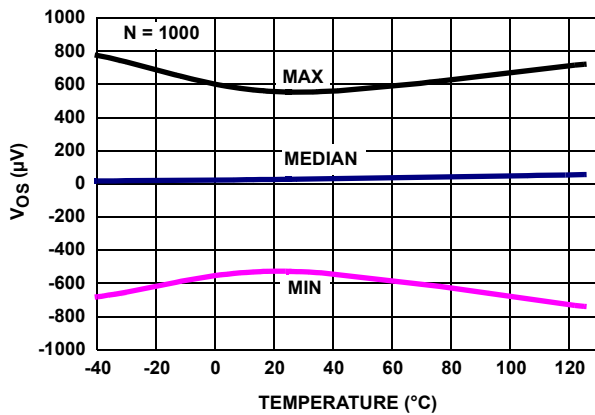

FIGURE 28.  $V_{OS}$  (SOT PKG) vs TEMPERATURE,  $V_{IN} = 0V, V_+, V_- = \pm 1.2V$

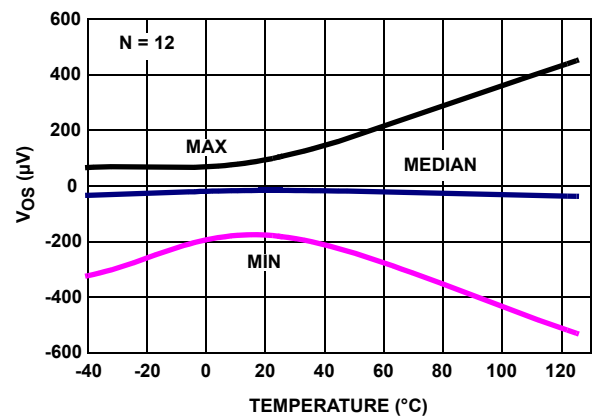

FIGURE 29.  $V_{OS}$  (MSOP PKG) vs TEMPERATURE,  $V_{IN} = 0V, V_+, V_- = \pm 2.5V$

**Typical Performance Curves**  $V_+ = 5V$ ,  $V_- = 0V$ ,  $V_{CM} = 2.5V$ ,  $R_L = \text{Open}$ . (Continued)

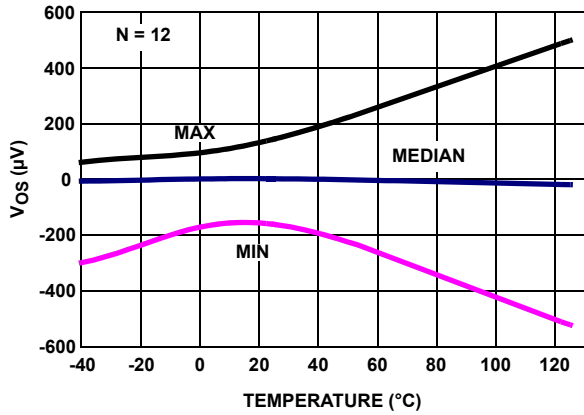

FIGURE 30.  $V_{OS}$  (MSOP PKG) vs TEMPERATURE,  $V_{IN} = 0V$ ,  $V_+$ ,  $V_- = \pm 1.2V$

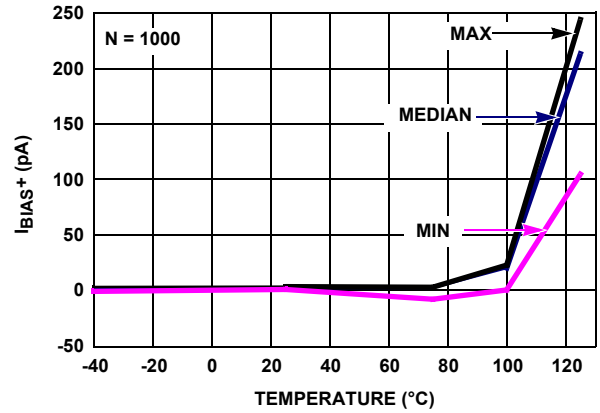

FIGURE 31.  $I_{BIAS+}$  vs TEMPERATURE,  $V_+$ ,  $V_- = \pm 2.5V$

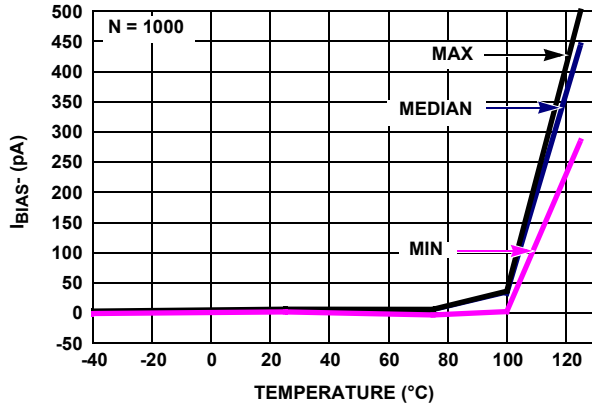

FIGURE 32.  $I_{BIAS-}$  vs TEMPERATURE,  $V_+$ ,  $V_- = \pm 2.5V$

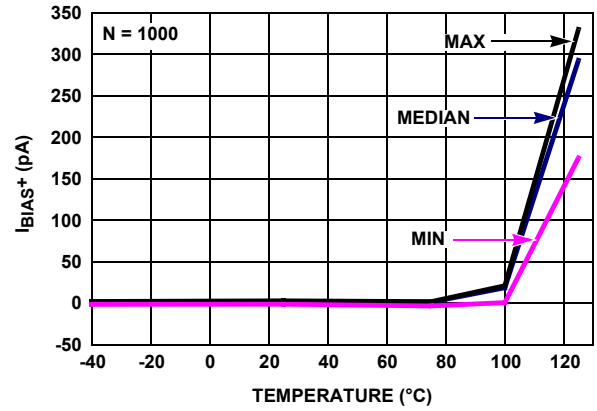

FIGURE 33.  $I_{BIAS+}$  vs TEMPERATURE,  $V_+$ ,  $V_- = \pm 1.2V$

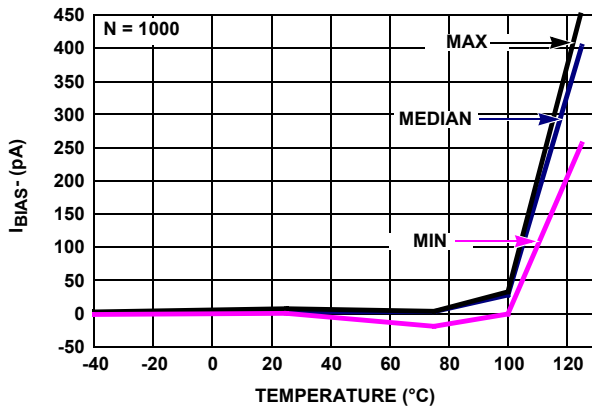

FIGURE 34.  $I_{BIAS-}$  vs TEMPERATURE,  $V_+$ ,  $V_- = \pm 1.2V$

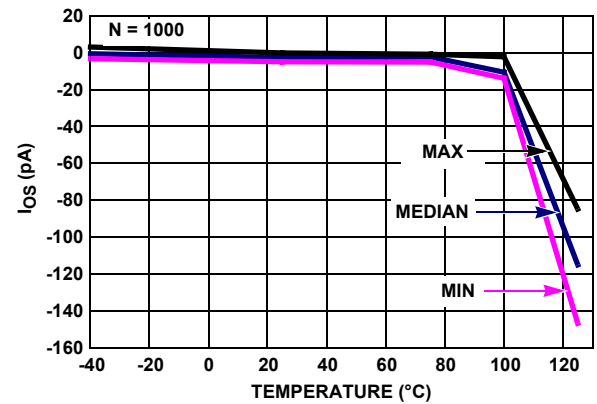

FIGURE 35.  $I_{OS}$  vs TEMPERATURE,  $V_+$ ,  $V_- = \pm 2.5V$

**Typical Performance Curves**  $V_+ = 5V, V_- = 0V, V_{CM} = 2.5V, R_L = \text{Open}$ . (Continued)

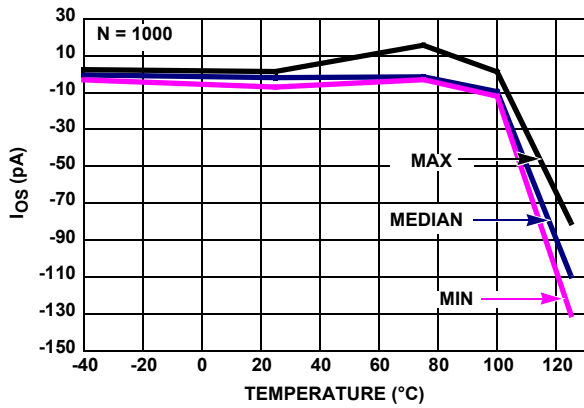

FIGURE 36.  $I_{OS}$  vs TEMPERATURE,  $V_+, V_- = \pm 1.2V$

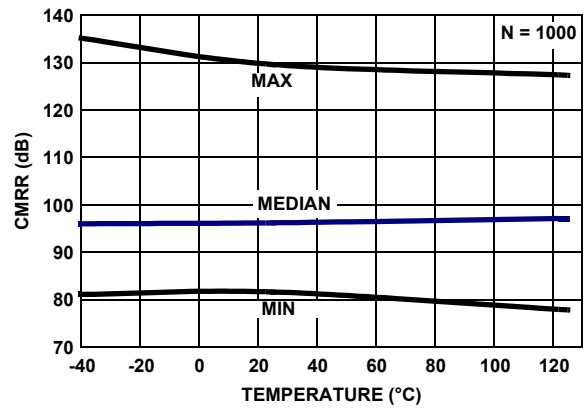

FIGURE 37. CMRR vs TEMPERATURE,  $V_{CM} = -2.5V \text{ TO } +2.5V, V_+, V_- = \pm 2.5V$

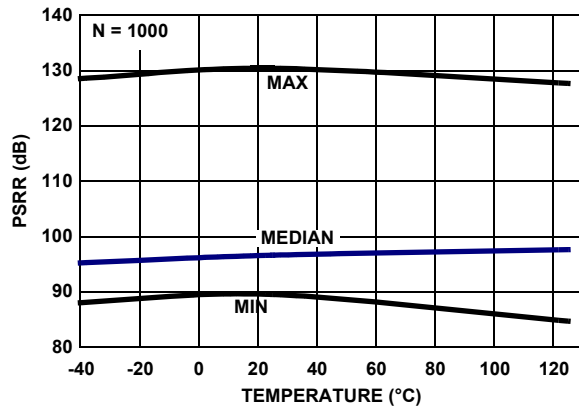

FIGURE 38. PSRR vs TEMPERATURE,  $V_+, V_- = \pm 1.2V \text{ TO } \pm 2.75V$

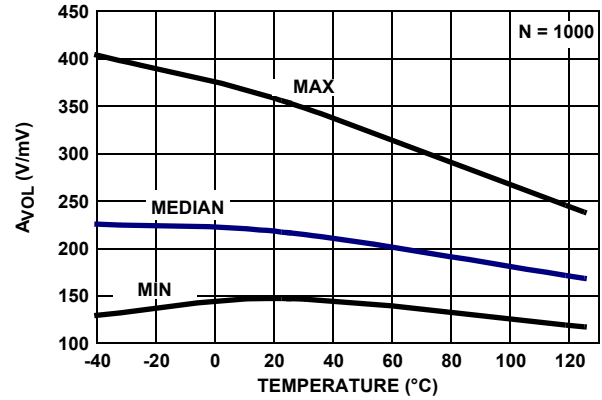

FIGURE 39.  $A_{VOL}$  vs TEMPERATURE,  $V_+, V_- = \pm 2.5V, V_O = -2V \text{ TO } +2V, R_L = 100k$

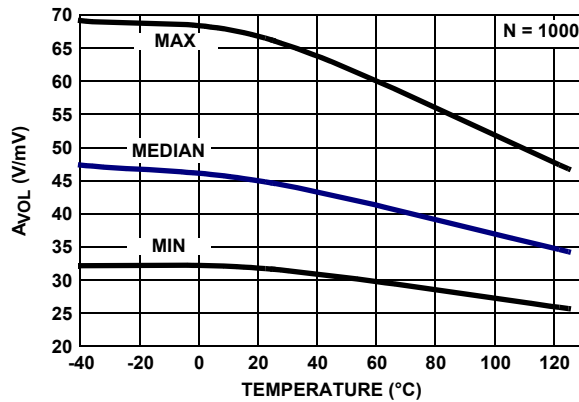

FIGURE 40.  $A_{VOL}$  vs TEMPERATURE,  $V_+, V_- = \pm 2.5V, V_O = -2V \text{ TO } +2V, R_L = 1k$

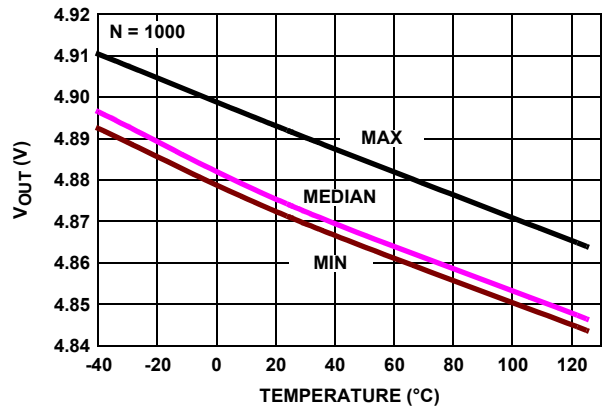

FIGURE 41.  $V_{OUT \text{ HIGH}}$  vs TEMPERATURE,  $V_+, V_- = \pm 2.5V, R_L = 1k$

**Typical Performance Curves**  $V_+ = 5V, V_- = 0V, V_{CM} = 2.5V, R_L = \text{Open}$ . (Continued)

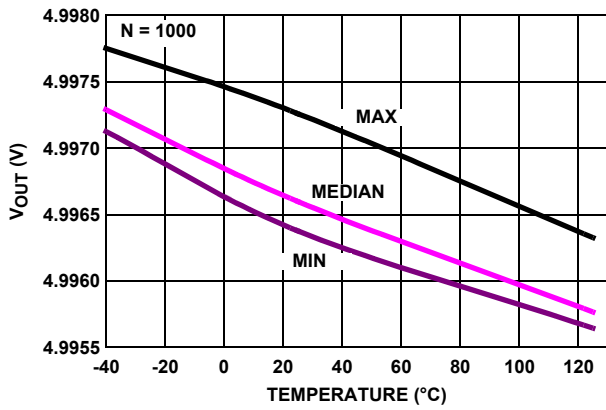

FIGURE 42.  $V_{OUT\ HIGH}$  vs TEMPERATURE,  $V_+, V_- = \pm 2.5V, R_L = 100k$

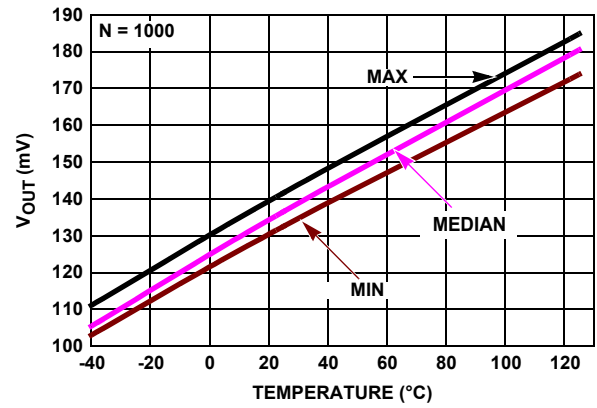

FIGURE 43.  $V_{OUT\ LOW}$  vs TEMPERATURE,  $V_+, V_- = \pm 2.5V, R_L = 1k$

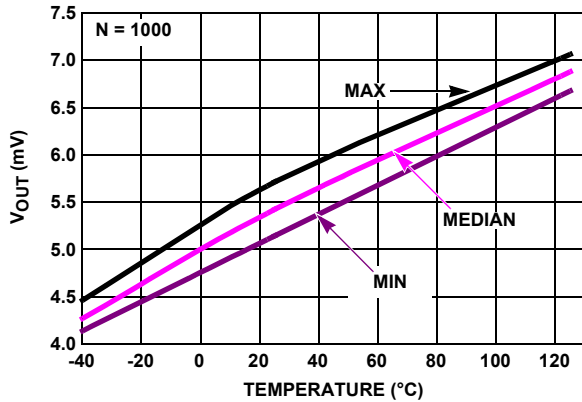

FIGURE 44.  $V_{OUT\ LOW}$  vs TEMPERATURE,  $V_+, V_- = \pm 2.5V, R_L = 100k$

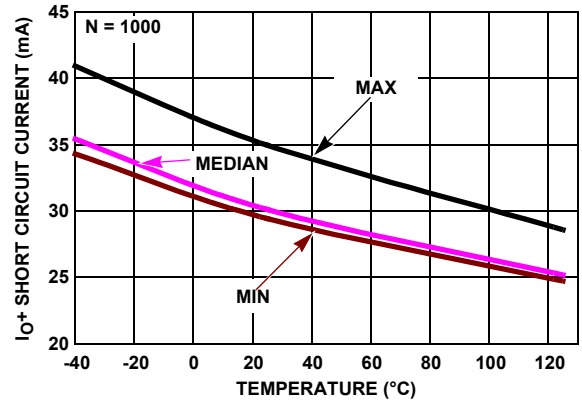

FIGURE 45.  $I_{O+}$  SHORT CIRCUIT OUTPUT CURRENT vs TEMPERATURE  $V_{IN} = -2.55V, R_L = 10k, V_+, V_- = \pm 2.5V$

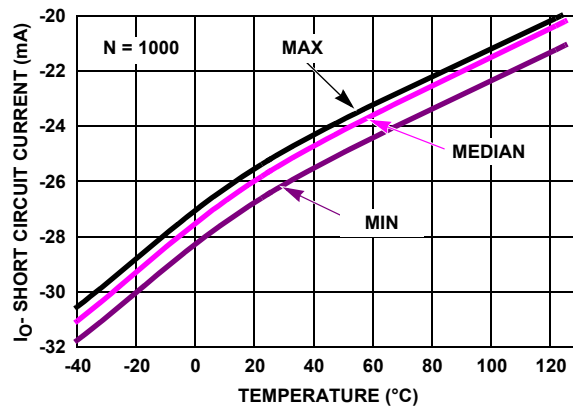

FIGURE 46.  $I_{O-}$  SHORT CIRCUIT OUTPUT CURRENT vs TEMPERATURE  $V_{IN} = +2.55V, R_L = 10k, V_+, V_- = \pm 2.5V$

**Pin Descriptions**

| ISL28158<br>(6 Ld SOT-23) | ISL28158<br>(8 Ld SOIC) | ISL28258<br>(8 Ld SOIC)<br>(8 Ld MSOP) | PIN NAME                  | FUNCTION            | EQUIVALENT CIRCUIT |
|---------------------------|-------------------------|--|---------------------------|---------------------|--------------------|
|                           | 1, 5                    |  | NC                        | Not connected       |                    |
| 4                         | 2                       | 2 (A)<br>6 (B)                         | IN-<br>IN- (A)<br>IN- (B) | inverting input     | <p>Circuit 1</p>   |
| 3                         | 3                       | 3 (A)<br>5 (B)                         | IN+<br>IN+ (A)<br>IN+ (B) | Non-inverting input | See Circuit 1      |
| 2                         | 4                       | 4                                      | V-                        | Negative supply     | <p>Circuit 2</p>   |
| 1                         | 6                       | 1 (A)<br>7 (B)                         | OUT<br>OUT (A)<br>OUT (B) | Output              | <p>Circuit 3</p>   |
| 6                         | 7                       | 8                                      | V+                        | Positive supply     | See Circuit 2      |
| 5                         | 8                       |  | $\overline{\text{EN}}$    | Chip enable         | <p>Circuit 3</p>   |

© Copyright Intersil Americas LLC 2007-2015. All Rights Reserved.  
 All trademarks and registered trademarks are the property of their respective owners.

For additional products, see [www.intersil.com/en/products.html](http://www.intersil.com/en/products.html)

Intersil products are manufactured, assembled and tested utilizing ISO9001 quality systems as noted in the quality certifications found at [www.intersil.com/en/support/qualandreliability.html](http://www.intersil.com/en/support/qualandreliability.html)

*Intersil products are sold by description only. Intersil may modify the circuit design and/or specifications of products at any time without notice, provided that such modification does not, in Intersil's sole judgment, affect the form, fit or function of the product. Accordingly, the reader is cautioned to verify that datasheets are current before placing orders. Information furnished by Intersil is believed to be accurate and reliable. However, no responsibility is assumed by Intersil or its subsidiaries for its use; nor for any infringements of patents or other rights of third parties which may result from its use. No license is granted by implication or otherwise under any patent or patent rights of Intersil or its subsidiaries.*

For information regarding Intersil Corporation and its products, see [www.intersil.com](http://www.intersil.com)

## Applications Information

### Introduction

The ISL28158 is a single CMOS rail-to-rail input, output (RRIO) operational amplifier with an enable feature. The ISL28258 is a dual version without the enable feature. Both devices are designed to operate from single supply (2.4V to 5.5V) or dual supplies ( $\pm 1.2V$  to  $\pm 2.75V$ ).

### Rail-to-Rail Input/Output

These devices feature PMOS inputs with an input common mode range that extends up to 0.3V beyond the V+ rail, and to 0.1V below the V- rail. The CMOS output features excellent drive capability, typically swinging to within 6mV of either rail with a 100k $\Omega$  load.

### Results of Over-Driving the Output

Caution should be used when over-driving the output for long periods of time. Over-driving the output can occur in two ways 1) The input voltage times the gain of the amplifier exceeds the supply voltage by a large value or, 2) the output current required is higher than the output stage can deliver. These conditions can result in a shift in the Input Offset Voltage ( $V_{OS}$ ) as much as 1 $\mu V/hr.$  of exposure under these conditions.

### IN+ and IN- Input Protection

All input terminals have internal ESD protection diodes to both positive and negative supply rails, limiting the input voltage to within one diode beyond the supply rails. They also contain back-to-back diodes across the input terminals (see "Pin Descriptions" on page 14 - Circuit 1). For applications where the input differential voltage is expected to exceed 0.5V, an external series resistor must be used to ensure the input currents never exceed 5mA (Figure 47).

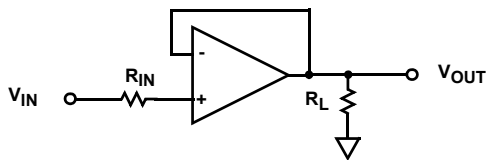

FIGURE 47. INPUT CURRENT LIMITING

### Enable/Disable Feature

The ISL28158 offers an  $\overline{EN}$  pin that disables the device when pulled up to at least 2.0V. In the disabled state (output in a high impedance state), the part consumes typically 10 $\mu A$  at room temperature. By disabling the part, multiple ISL28158 parts can be connected together as a MUX. In this configuration, the outputs are tied together in parallel and a channel can be selected by the  $\overline{EN}$  pin. The loading effects of the feedback resistors of the disabled amplifier must be considered when multiple amplifier outputs are connected together. Note that feed through from the IN+ to IN- pins occurs on any Mux Amp disabled channel where the input differential voltage exceeds 0.5V (e.g., active channel  $V_{OUT} = 1V$ , while disabled channel  $V_{IN} = GND$ ), so the mux

implementation is best suited for small signal applications. If large signals are required, use series IN+ resistors, or large value  $R_F$ , to keep the feed through current low enough to minimize the impact on the active channel. See "Limitations of the Differential Input Protection" on page 15 for more details. The  $\overline{EN}$  pin also has an internal pull-down. If left open, the  $\overline{EN}$  pin will pull to the negative rail and the device will be enabled by default. When not used, the  $\overline{EN}$  pin should either be left floating or connected directly to the -V pin.

### Limitations of the Differential Input Protection

If the input differential voltage is expected to exceed 0.5V, an external current limiting resistor must be used to ensure the input current never exceeds 5mA. For non-inverting unity gain applications, the current limiting can be via a series IN+ resistor, or via a feedback resistor of appropriate value. For other gain configurations, the series IN+ resistor is the best choice, unless the feedback ( $R_F$ ) and gain setting ( $R_G$ ) resistors are both sufficiently large to limit the input current to 5mA.

Large differential input voltages can arise from several sources:

- 1) During open loop (comparator) operation. Used this way, the IN+ and IN- voltages don't track, so differentials arise.
- 2) When the amplifier is disabled but an input signal is still present. An  $R_L$  or  $R_G$  to GND keeps the IN- at GND, while the varying IN+ signal creates a differential voltage. Mux Amp applications are similar, except that the active channel  $V_{OUT}$  determines the voltage on the IN- terminal.
- 3) When the slew rate of the input pulse is considerably faster than the op amp's slew rate. If the  $V_{OUT}$  can't keep up with the IN+ signal, a differential voltage results, and visible distortion occurs on the input and output signals. To avoid this issue, keep the input slew rate below 0.1V/ $\mu s$ , or use appropriate current limiting resistors.

Large (>2V) differential input voltages can also cause an increase in disabled  $I_{CC}$ .

**Using Only One Channel**

The ISL28258 is a dual op amp. If the application only requires one channel, the user must configure the unused channel to prevent it from oscillating. The unused channel will oscillate if the input and output pins are floating. This will result in higher than expected supply currents and possible noise injection into the channel being used. The proper way to prevent this oscillation is to short the output to the negative input and ground the positive input (as shown in Figure 48).

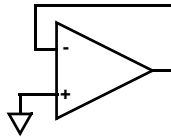

**FIGURE 48. PREVENTING OSCILLATIONS IN UNUSED CHANNELS**

**Current Limiting**

These devices have no internal current-limiting circuitry. If the output is shorted, it is possible to exceed the Absolute Maximum Rating for output current or power dissipation, potentially resulting in the destruction of the device.

**Power Dissipation**

It is possible to exceed the +125°C maximum junction temperatures under certain load and power-supply conditions. It is therefore important to calculate the maximum junction

temperature ( $T_{JMAX}$ ) for all applications to determine if power supply voltages, load conditions, or package type need to be modified to remain in the safe operating area. These parameters are related in Equation 1:

$$T_{JMAX} = T_{MAX} + (\theta_{JA} \times PD_{MAXTOTAL}) \tag{EQ. 1}$$

where:

- $PD_{MAXTOTAL}$  is the sum of the maximum power dissipation of each amplifier in the package ( $PD_{MAX}$ )
- $PD_{MAX}$  for each amplifier can be calculated using Equation 2:

$$PD_{MAX} = 2 \times V_S \times I_{SMAX} + (V_S - V_{OUTMAX}) \times \frac{V_{OUTMAX}}{R_L} \tag{EQ. 2}$$

where:

- $T_{MAX}$  = Maximum ambient temperature
- $\theta_{JA}$  = Thermal resistance of the package
- $PD_{MAX}$  = Maximum power dissipation of 1 amplifier
- $V_S$  = Supply voltage (Magnitude of  $V_+$  and  $V_-$ )
- $I_{MAX}$  = Maximum supply current of 1 amplifier
- $V_{OUTMAX}$  = Maximum output voltage swing of the application
- $R_L$  = Load resistance

**Revision History**

The revision history provided is for informational purposes only and is believed to be accurate, but not warranted. Please go to the web to make sure that you have the latest revision.

| DATE             | REVISION | CHANGE   |
|------------------|----------|--|
| October 12, 2015 | FN6377.5 | Updated Ordering Information Table on page 2.<br>Added Revision History and About Intersil sections. |

**About Intersil**

Intersil Corporation is a leading provider of innovative power management and precision analog solutions. The company's products address some of the largest markets within the industrial and infrastructure, mobile computing and high-end consumer markets.

For the most updated datasheet, application notes, related documentation and related parts, please see the respective product information page found at [www.intersil.com](http://www.intersil.com).

You may report errors or suggestions for improving this datasheet by visiting [www.intersil.com/ask](http://www.intersil.com/ask).

Reliability reports are also available from our website at [www.intersil.com/support](http://www.intersil.com/support)

# Package Outline Drawing

## P6.064A

6 LEAD SMALL OUTLINE TRANSISTOR PLASTIC PACKAGE

Rev 0, 2/10

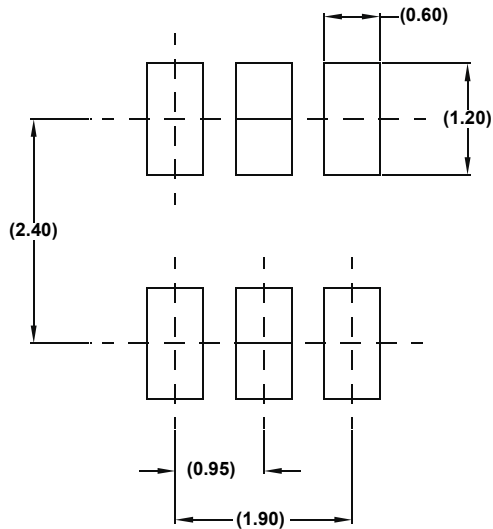
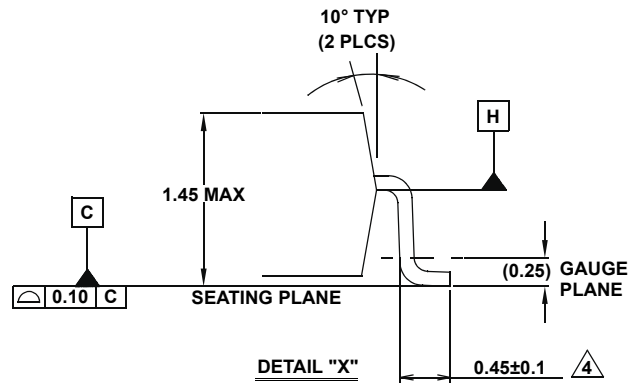
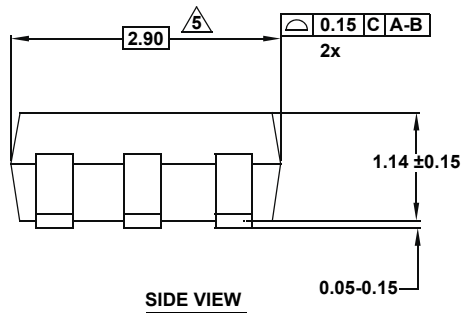
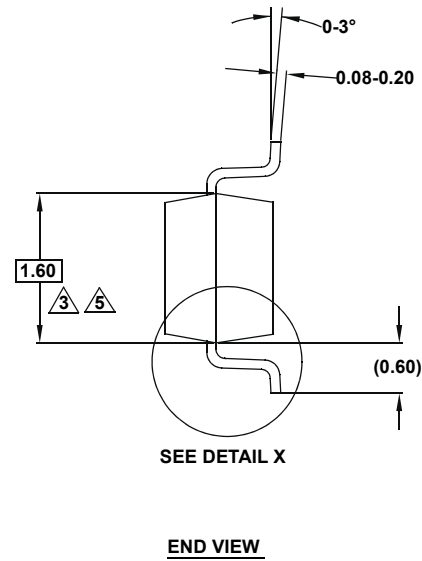
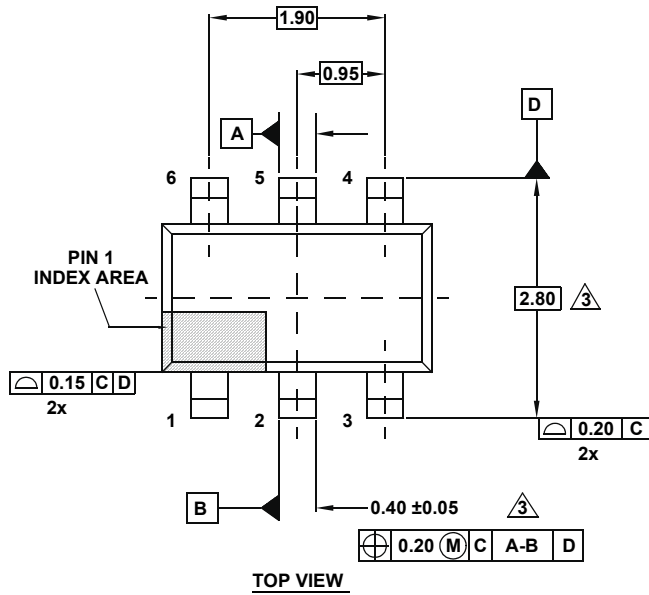

**NOTES:**

1. Dimensions are in millimeters.  
Dimensions in ( ) for Reference Only.
2. Dimensioning and tolerancing conform to ASME Y14.5M-1994.
3. Dimension is exclusive of mold flash, protrusions or gate burrs.
4. Foot length is measured at reference to gauge plane.
5. This dimension is measured at Datum "H".
6. Package conforms to JEDEC MO-178AA.

# Package Outline Drawing

## M8.15E

### 8 LEAD NARROW BODY SMALL OUTLINE PLASTIC PACKAGE

Rev 0, 08/09

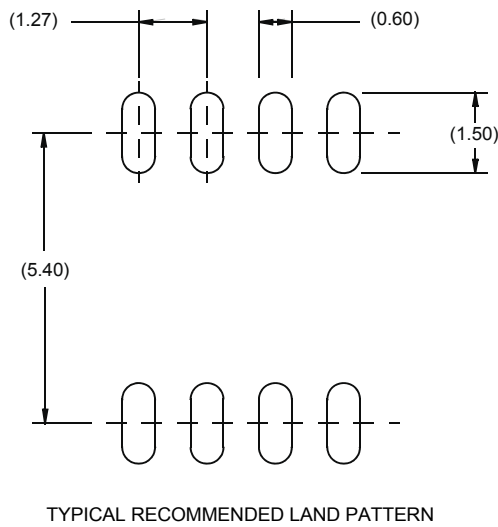
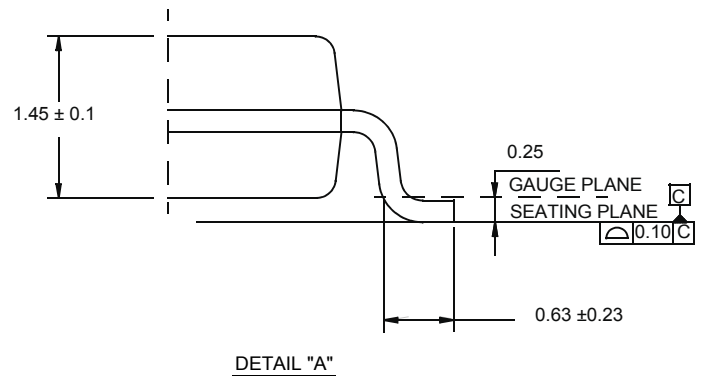
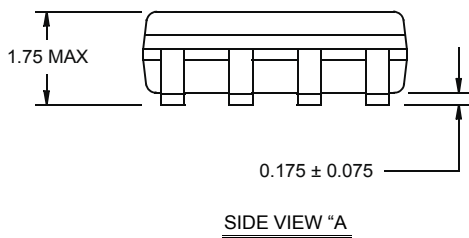
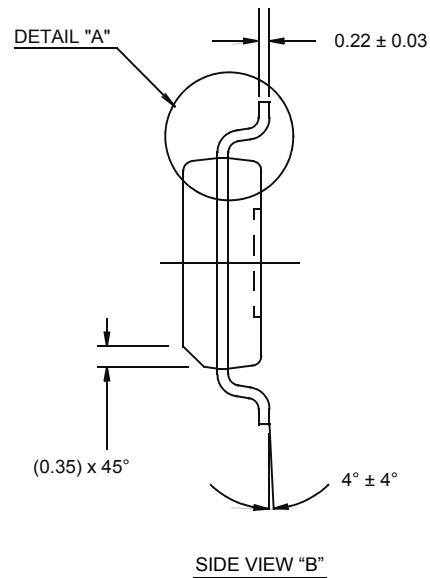
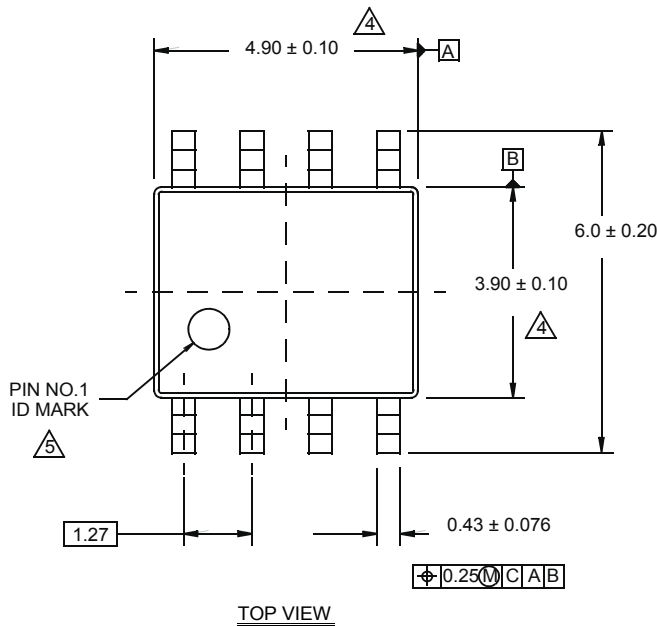

**NOTES:**

1. Dimensions are in millimeters.  
Dimensions in ( ) for Reference Only.
2. Dimensioning and tolerancing conform to AMSE Y14.5m-1994.
3. Unless otherwise specified, tolerance : Decimal ± 0.05
4. Dimension does not include interlead flash or protrusions.  
Interlead flash or protrusions shall not exceed 0.25mm per side.
5. The pin #1 identifier may be either a mold or mark feature.
6. Reference to JEDEC MS-012.

# Package Outline Drawing

## M8.118A

8 LEAD MINI SMALL OUTLINE PLASTIC PACKAGE (MSOP)

Rev 0, 9/09

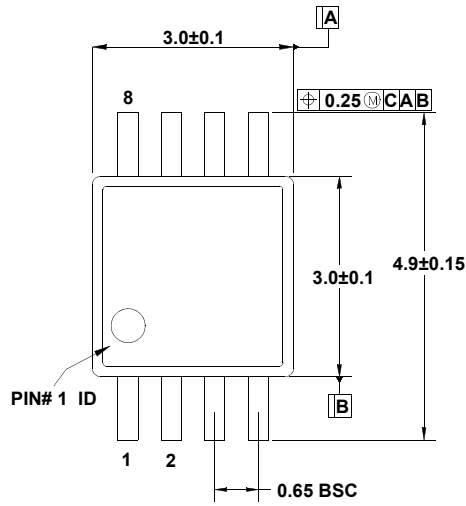

TOP VIEW

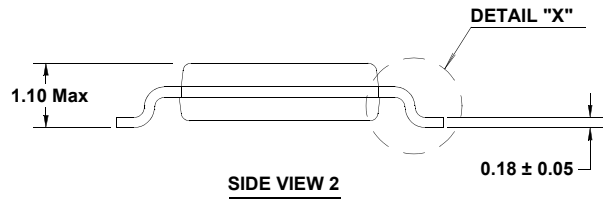

SIDE VIEW 2

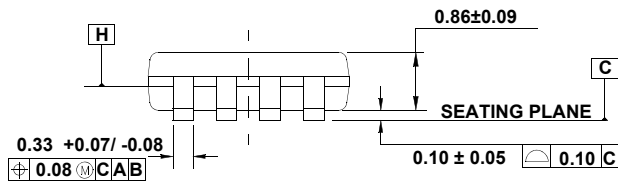

SIDE VIEW 1

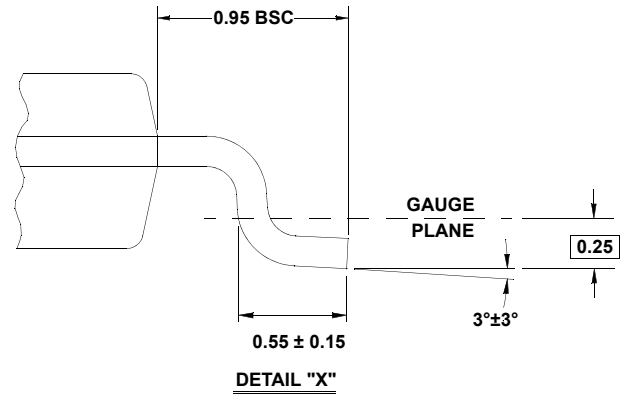

DETAIL "X"

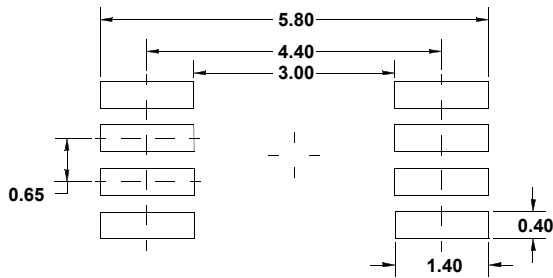



TYPICAL RECOMMENDED LAND PATTERN

### NOTES:

1. Dimensions are in millimeters.
2. Dimensioning and tolerancing conform to JEDEC MO-187-AA and AMSE Y14.5m-1994.
3. Plastic or metal protrusions of 0.15mm max per side are not included.
4. Plastic interlead protrusions of 0.25mm max per side are not included.
5. Dimensions "D" and "E1" are measured at Datum Plane "H".
6. This replaces existing drawing # MDP0043 MSOP 8L.

## Looking for pricing, stock, or lifecycle information?

Click below to explore more details on WIN SOURCE:

-  [View ISL28258FBZ on WIN SOURCE](#)
-  [Renesas Electronics America](#) Information

## Optimize Your Supply Chain with WIN SOURCE Solutions

-  Global Sourcing Solution
-  Obsolete Management
-  Cost Control Management
-  Shortage Management
-  Alternative Solution
-  Excess Inventory Management