



**THE DATASHEET OF  
ISL28217FBBZ**



ISL28117, ISL28217, ISL28417, ISL28417SEH

40V Precision Low Power Operational Amplifiers

FN6632  
Rev.13.00  
Sep 13, 2019

The [ISL28117](#), [ISL28217](#), [ISL28417](#), and [ISL28417SEH](#) are a family of very high precision amplifiers featuring low noise vs power consumption, low offset voltage, low bias current, and low temperature drift making them the ideal choice for applications requiring both high DC accuracy and AC performance. The combination of precision, low noise, and small footprint provides you with outstanding value and flexibility relative to similar competitive parts.

Applications for these amplifiers include precision active filters, medical and analytical instrumentation, precision power supply controls, and industrial controls.

The ISL28117 single and ISL28217 dual are offered in 8 Ld SOIC, MSOP and TDFN packages. The ISL28417 is offered in 14 Ld SOIC, 14 Ld TSSOP packages. All devices are offered in standard pin configurations and operate across the extended temperature range from -40°C to +125°C.

The ISL28417SEH is offered in a 14 Ld Hermetic Ceramic Flatpack package. The device is offered in an industry standard pin configuration and operates across the extended temperature range from -55°C to +125°C.

**Related Literature**

For a full list of related documents, visit our website

- [ISL28117](#), [ISL28217](#), [ISL28417](#), and [ISL28417SEH](#) device pages

**Features**

- Low input offset voltage .....  $\pm 50\mu\text{V}$ , maximum  
ISL28417SEH  $\pm 110\mu\text{V}$ , maximum
- Superb offset voltage TC .....  $0.6\mu\text{V}/^\circ\text{C}$ , maximum  
ISL28417SEH  $1\mu\text{V}/^\circ\text{C}$ , maximum
- Input bias current .....  $\pm 1\text{nA}$ , maximum  
ISL28417SEH  $\pm 5\text{nA}$ , maximum
- Input bias current TC .....  $\pm 5\text{pA}/^\circ\text{C}$ , maximum
- Low current consumption .....  $440\mu\text{A}$
- Voltage noise .....  $8\text{nV}/\text{Hz}$
- Wide supply range .....  $4.5\text{V}$  to  $40\text{V}$
- Operating temperature range .....  $-40^\circ\text{C}$  to  $+125^\circ\text{C}$   
ISL28417SEH  $-55^\circ\text{C}$  to  $+125^\circ\text{C}$
- Small package offerings in single, dual and quad
- Pb-free (RoHS compliant)
- No phase reversal

**Applications**

- Precision instruments
- Medical instrumentation
- Power supply control
- Active filter blocks
- Thermocouples and RTD reference buffers
- Data acquisition

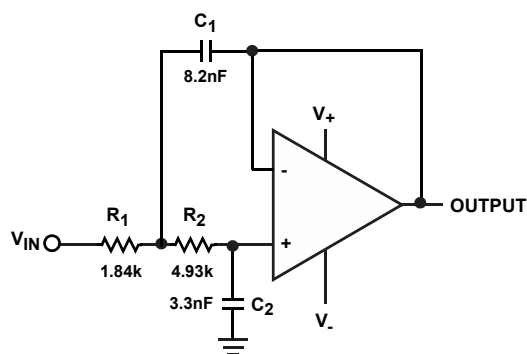

SALLEN-KEY LOW PASS FILTER (10kHz)

FIGURE 1. TYPICAL APPLICATION

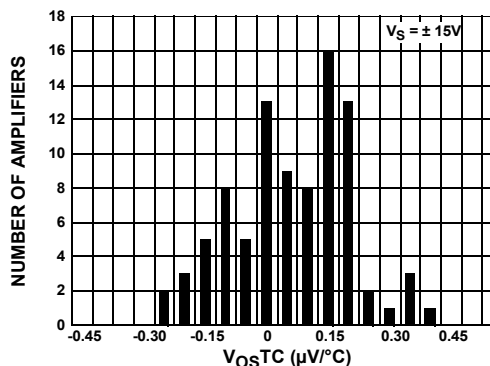

FIGURE 2. V<sub>OS</sub> TEMPERATURE COEFFICIENT (V<sub>OSTC</sub>)

## Table of Contents

|  |           |
|--|-----------|
| <b>Ordering Information</b> .....  | <b>3</b>  |
| <b>Pin Configurations</b> .....  | <b>5</b>  |
| <b>Pin Descriptions</b> .....  | <b>6</b>  |
| <b>Absolute Maximum Ratings</b> .....  | <b>7</b>  |
| <b>Thermal Information</b> .....   | <b>7</b>  |
| <b>Recommended Operating Conditions</b> .....  | <b>7</b>  |
| <b>Electrical Specifications ISL28117, ISL28217, ISL28417 (<math>V_S \pm 15V</math>)</b> ..... | <b>8</b>  |
| <b>Electrical Specifications ISL28117, ISL28217, ISL28417 (<math>V_S \pm 5V</math>)</b> .....  | <b>10</b> |
| <b>Electrical Specifications ISL28417SEH (<math>V_S \pm 15V</math>)</b> .....                  | <b>12</b> |
| <b>Electrical Specifications ISL28417SEH (<math>V_S \pm 5V</math>)</b> .....                   | <b>13</b> |
| <b>Typical Performance Curves</b> .....  | <b>15</b> |
| <b>Applications Information</b> .....  | <b>24</b> |
| Functional Description .....   | 24        |
| Operating Voltage Range .....  | 24        |
| Input Performance .....  | 24        |
| Input ESD Diode Protection .....   | 24        |
| Output Current Limiting .....  | 24        |
| Output Phase Reversal .....  | 24        |
| Unused Channels .....  | 24        |
| Power Dissipation .....  | 25        |
| ISL28117, ISL28217, ISL28417, ISL28417SEH SPICE Model .....                                    | 25        |
| License Statement .....  | 25        |
| <b>Characterization vs Simulation Results</b> .....  | <b>28</b> |
| <b>Metallization Mask Layout</b> .....   | <b>30</b> |
| <b>Revision History</b> .....  | <b>31</b> |
| <b>Package Outline Drawings</b> .....  | <b>36</b> |

## Ordering Information

| PART NUMBER<br>(Notes 2, 5) | PART<br>MARKING | V <sub>OS</sub> (MAX)<br>( $\mu$ V) | TAPE AND REEL<br>(UNITS) (Note 1) | PACKAGE<br>(RoHS Compliant) | PKG.<br>DWG. # |
|-----------------------------|-----------------|-------------------------------------|-----------------------------------|-----------------------------|----------------|
| ISL28117FBBZ                | 28117 FBZ       | 50 (B Grade)                        | -                                 | 8 Ld SOIC                   | M8.15E         |
| ISL28117FBBZ-T13            | 28117 FBZ       | 50 (B Grade)                        | 2.5k                              | 8 Ld SOIC                   | M8.15E         |
| ISL28117FBBZ-T7             | 28117 FBZ       | 50 (B Grade)                        | 1k                                | 8 Ld SOIC                   | M8.15E         |
| ISL28117FBBZ-T7A            | 28117 FBZ       | 50 (B Grade)                        | 250                               | 8 Ld SOIC                   | M8.15E         |
| ISL28117FBZ                 | 28117 FBZ -C    | 100 (C Grade)                       | -                                 | 8 Ld SOIC                   | M8.15E         |
| ISL28117FBZ-T13             | 28117 FBZ -C    | 100 (C Grade)                       | 2.5k                              | 8 Ld SOIC                   | M8.15E         |
| ISL28117FBZ-T7              | 28117 FBZ -C    | 100 (C Grade)                       | 1k                                | 8 Ld SOIC                   | M8.15E         |
| ISL28117FBZ-T7A             | 28117 FBZ -C    | 100 (C Grade)                       | 250                               | 8 Ld SOIC                   | M8.15E         |
| ISL28117FUBZ                | 8117Z           | 70 (B Grade)                        | -                                 | 8 Ld MSOP                   | M8.118B        |
| ISL28117FUBZ-T13            | 8117Z           | 70 (B Grade)                        | 2.5k                              | 8 Ld MSOP                   | M8.118B        |
| ISL28117FUBZ-T7             | 8117Z           | 70 (B Grade)                        | 1.5k                              | 8 Ld MSOP                   | M8.118B        |
| ISL28117FUBZ-T7A            | 8117Z           | 70 (B Grade)                        | 250                               | 8 Ld MSOP                   | M8.118B        |
| ISL28117FUZ                 | 8117Z -C        | 150 (C Grade)                       | -                                 | 8 Ld MSOP                   | M8.118B        |
| ISL28117FUZ-T13             | 8117Z -C        | 150 (C Grade)                       | 2.5k                              | 8 Ld MSOP                   | M8.118B        |
| ISL28117FUZ-T7              | 8117Z -C        | 150 (C Grade)                       | 1.5k                              | 8 Ld MSOP                   | M8.118B        |
| ISL28117FUZ-T7A             | 8117Z -C        | 150 (C Grade)                       | 250                               | 8 Ld MSOP                   | M8.118B        |
| ISL28117FRTBZ               | 8117            | 75 (B Grade)                        | -                                 | 8 Ld TDFN                   | L8.3x3K        |
| ISL28117FRTBZ-T13           | 8117            | 75 (B Grade)                        | 6k                                | 8 Ld TDFN                   | L8.3x3K        |
| ISL28117FRTBZ-T7            | 8117            | 75 (B Grade)                        | 1k                                | 8 Ld TDFN                   | L8.3x3K        |
| ISL28117FRTBZ-T7A           | 8117            | 75 (B Grade)                        | 250                               | 8 Ld TDFN                   | L8.3x3K        |
| ISL28117FRTZ                | -C 8117         | 150 (C Grade)                       | -                                 | 8 Ld TDFN                   | L8.3x3K        |
| ISL28117FRTZ-T13            | -C 8117         | 150 (C Grade)                       | 2.5k                              | 8 Ld TDFN                   | L8.3x3K        |
| ISL28117FRTZ-T7             | -C 8117         | 150 (C Grade)                       | 1k                                | 8 Ld TDFN                   | L8.3x3K        |
| ISL28117FRTZ-T7A            | -C 8117         | 150 (C Grade)                       | 250                               | 8 Ld TDFN                   | L8.3x3K        |
| ISL28217FBBZ                | 28217 FBZ       | 50 (B Grade)                        | -                                 | 8 Ld SOIC                   | M8.15E         |
| ISL28217FBBZ-T13            | 28217 FBZ       | 50 (B Grade)                        | 2.5k                              | 8 Ld SOIC                   | M8.15E         |
| ISL28217FBBZ-T7             | 28217 FBZ       | 50 (B Grade)                        | 1k                                | 8 Ld SOIC                   | M8.15E         |
| ISL28217FBBZ-T7A            | 28217 FBZ       | 50 (B Grade)                        | 250                               | 8 Ld SOIC                   | M8.15E         |
| ISL28217FBZ                 | 28217 FBZ -C    | 100 (C Grade)                       | -                                 | 8 Ld SOIC                   | M8.15E         |
| ISL28217FBZ-T13             | 28217 FBZ -C    | 100 (C Grade)                       | 2.5k                              | 8 Ld SOIC                   | M8.15E         |
| ISL28217FBZ-T7              | 28217 FBZ -C    | 100 (C Grade)                       | 1k                                | 8 Ld SOIC                   | M8.15E         |
| ISL28217FBZ-T7A             | 28217 FBZ -C    | 100 (C Grade)                       | 250                               | 8 Ld SOIC                   | M8.15E         |
| ISL28217FUZ                 | 8217Z -C        | 150 (C Grade)                       | -                                 | 8 Ld MSOP                   | M8.118B        |
| ISL28217FUZ-T13             | 8217Z -C        | 150 (C Grade)                       | 2.5k                              | 8 Ld MSOP                   | M8.118B        |
| ISL28217FUZ-T7              | 8217Z -C        | 150 (C Grade)                       | 1k                                | 8 Ld MSOP                   | M8.118B        |
| ISL28217FUZ -T7A            | 8217Z -C        | 150 (C Grade)                       | 250                               | 8 Ld MSOP                   | M8.118B        |
| ISL28217FRTBZ               | 8217            | 70 (B Grade)                        | -                                 | 8 Ld TDFN                   | L8.3x3K        |
| ISL28217FRTBZ-T13           | 8217            | 70 (B Grade)                        | 2.5k                              | 8 Ld TDFN                   | L8.3x3K        |
| ISL28217FRTBZ-T7            | 8217            | 70 (B Grade)                        | 1k                                | 8 Ld TDFN                   | L8.3x3K        |
| ISL28217FRTZ                | -C 8217         | 150 (C Grade)                       | -                                 | 8 Ld TDFN                   | L8.3x3K        |

## Ordering Information

| PART NUMBER<br>(Notes 2, 5)     | PART MARKING       | V <sub>OS</sub> (MAX)<br>( $\mu$ V) | TAPE AND REEL<br>(UNITS) (Note 1) | PACKAGE<br>(RoHS Compliant) | PKG.<br>DWG. # |
|---------------------------------|--------------------|-------------------------------------|-----------------------------------|-----------------------------|----------------|
| ISL28217FRTZ-T13                | -C 8217            | 150 (C Grade)                       | 2.5k                              | 8 Ld TDFN                   | L8.3x3K        |
| ISL28217FRTZ-T7                 | -C 8217            | 150 (C Grade)                       | 1k                                | 8 Ld TDFN                   | L8.3x3K        |
| ISL28417FBBZ                    | 28417 FBZ          | 120 (B Grade)                       | -                                 | 14 Ld SOIC                  | MDP0027        |
| ISL28417FBBZ-T13                | 28417 FBZ          | 120 (B Grade)                       | 2.5k                              | 14 Ld SOIC                  | MDP0027        |
| ISL28417FBBZ-T7                 | 28417 FBZ          | 120 (B Grade)                       | 1k                                | 14 Ld SOIC                  | MDP0027        |
| ISL28417FBBZ-T7A                | 28417 FBZ          | 120 (B Grade)                       | 250                               | 14 Ld SOIC                  | MDP0027        |
| ISL28417FBZ                     | 28417 FBZ -C       | 200 (C Grade)                       | -                                 | 14 Ld SOIC                  | MDP0027        |
| ISL28417FBZ-T13                 | 28417 FBZ -C       | 200 (C Grade)                       | 2.5k                              | 14 Ld SOIC                  | MDP0027        |
| ISL28417FBZ-T7                  | 28417 FBZ -C       | 200 (C Grade)                       | 1k                                | 14 Ld SOIC                  | MDP0027        |
| ISL28417FBZ-T7A                 | 28417 FBZ -C       | 200 (C Grade)                       | 250                               | 14 Ld SOIC                  | MDP0027        |
| ISL28417FVBZ                    | 28417 FVZ          | 120 (B Grade)                       | -                                 | 14 Ld TSSOP                 | M14.173        |
| ISL28417FVBZ-T13                | 28417 FVZ          | 120 (B Grade)                       | 2.5k                              | 14 Ld TSSOP                 | M14.173        |
| ISL28417FVBZ-T7                 | 28417 FVZ          | 120 (B Grade)                       | 1k                                | 14 Ld TSSOP                 | M14.173        |
| ISL28417FVBZ-T7A                | 28417 FVZ          | 120 (B Grade)                       | 250                               | 14 Ld TSSOP                 | M14.173        |
| ISL28417FVZ                     | 28417 FVZ-C        | 200 (C Grade)                       | -                                 | 14 Ld TSSOP                 | M14.173        |
| ISL28417FVZ-T13                 | 28417 FVZ-C        | 200 (C Grade)                       | 2.5k                              | 14 Ld TSSOP                 | M14.173        |
| ISL28417FVZ-T7                  | 28417 FVZ-C        | 200 (C Grade)                       | 1k                                | 14 Ld TSSOP                 | M14.173        |
| ISL28417FVZ-T7A                 | 28417 FVZ-C        | 200 (C Grade)                       | 250                               | 14 Ld TSSOP                 | M14.173        |
| ISL28417SEHMF (Note 3)          | ISL28417SEHMF      | 110 (B Grade)                       | -                                 | 14 Ld Flatpack              | K14.A          |
| ISL28417SEHF/PROTO (Notes 3, 4) | ISL28417SEHF/PROTO | 110 (B Grade)                       | -                                 | 14 Ld Flatpack              | K14.A          |
| ISL28417SEHMX                   |                    | 110 (B Grade)                       | -                                 | DIE                         |                |
| ISL28417SEHX/SAMPLE (Note 4)    |                    | 110 (B Grade)                       | -                                 | DIE                         |                |
| ISL28117SOICEVAL1Z              | Evaluation Board   |                                     |                                   |                             |                |
| ISL28217SOICEVAL2Z              | Evaluation Board   |                                     |                                   |                             |                |

### NOTES:

- See [TB347](#) for details about reel specifications.
- These Pb-free plastic packaged products employ special Pb-free material sets, molding compounds/die attach materials, and 100% matte tin plate plus anneal (e3 termination finish, which is RoHS compliant and compatible with both SnPb and Pb-free soldering operations). Pb-free products are MSL classified at Pb-free peak reflow temperatures that meet or exceed the Pb-free requirements of IPC/JEDEC J-STD-020.
- These Pb-free Hermetic packaged products employ 100% Au plate - e4 termination finish, which is RoHS compliant and compatible with both SnPb and Pb-free soldering operations.
- The /PROTO and /SAMPLE are not rated or certified for Total Ionizing Dose (TID) or Single Event Effect (SEE) immunity. These parts are intended for engineering evaluation purposes only. The /PROTO parts meet the electrical limits and conditions across temperature specified in this datasheet. The /SAMPLE parts are capable of meeting the electrical limits and conditions at +25°C only. The /SAMPLE parts do not receive 100% screening across temperature to the electrical limits. These part types do not come with a Certificate of Conformance.
- For Moisture Sensitivity Level (MSL), see the [ISL28117](#), [ISL28217](#), and [ISL28417](#) device pages. For more information about MSL, see [TB363](#).

TABLE 1. KEY DIFFERENCES BETWEEN FAMILY OF PARTS

| PART NUMBER | NUMBER OF DEVICES | PACKAGE        | OPERATING TEMPERATURE RANGE |
|-------------|-------------------|----------------|-----------------------------|
| ISL28117    | 1                 | 8 Ld SOIC      | -40°C to +125°C             |
| ISL28217    | 2                 | 8 Ld SOIC      | -40°C to +125°C             |
| ISL28417    | 4                 | 14 Ld SOIC     | -40°C to +125°C             |
| ISL28417SEH | 4                 | 14 Ld Flatpack | -55°C to +125°C             |

## Pin Configurations

ISL28117  
(8 LD SOIC, MSOP)  
TOP VIEW

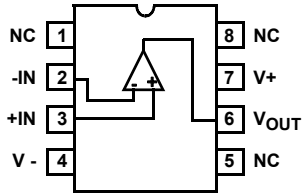

ISL28117  
(8 LD TDFN)  
TOP VIEW

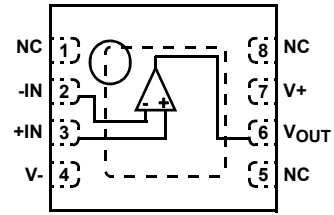

ISL28217  
(8 LD SOIC, MSOP)  
TOP VIEW

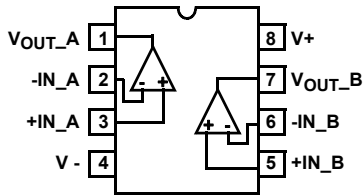

ISL28217  
(8 LD TDFN)  
TOP VIEW

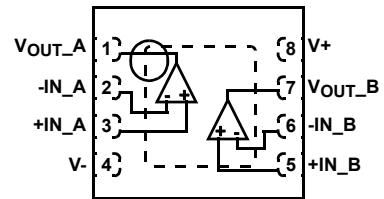

ISL28417  
(14 LD SOIC, TSSOP)  
TOP VIEW

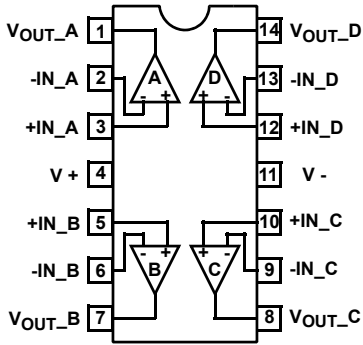

ISL28417SEH  
(14 LD FLATPACK)  
TOP VIEW

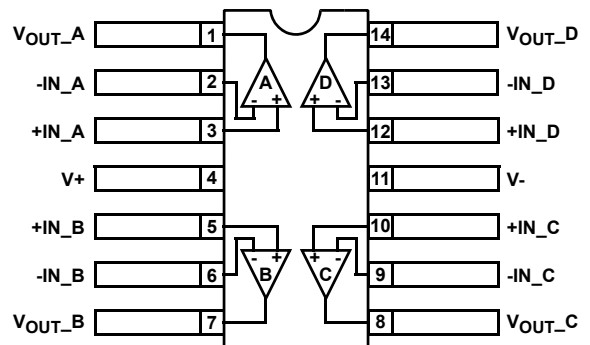

## Pin Descriptions

| ISL28117<br>(8 Ld SOIC,<br>MSOP, TDFN) | ISL28217<br>(8 Ld SOIC,<br>MSOP, TDFN) | ISL28417/SEH<br>(14 Ld SOIC, TSSOP)<br>(14 Ld FLATPACK) | PIN NAME           | EQUIVALENT CIRCUIT | DESCRIPTION   |
|--|--|---|--------------------|--------------------|---|
| 3                                      | -                                      | -   | +IN                | Circuit 1          | Amplifier noninverting input  |
| -                                      | 3                                      | 3   | +IN_A              |                    |   |
| -                                      | 5                                      | 5   | +IN_B              |                    |   |
| -                                      | -                                      | 10  | +IN_C              |                    |   |
| -                                      | -                                      | 12  | +IN_D              |                    |   |
| 4                                      | 4                                      | 11  | V-                 | Circuit 3          | Negative power supply   |
| 2                                      | -                                      | -   | -IN                | Circuit 1          | Amplifier inverting input   |
| -                                      | 2                                      | 2   | -IN_A              |                    |   |
| -                                      | 6                                      | 6   | -IN_B              |                    |   |
| -                                      | -                                      | 9   | -IN_C              |                    |   |
| -                                      | -                                      | 13  | -IN_D              |                    |   |
| 7                                      | 8                                      | 4   | V+                 | Circuit 3          | Positive power supply   |
| 6                                      | -                                      | -   | V <sub>OUT</sub>   | Circuit 2          | Amplifier output  |
| -                                      | 1                                      | 1   | V <sub>OUT_A</sub> |                    |   |
| -                                      | 7                                      | 7   | V <sub>OUT_B</sub> |                    |   |
| -                                      | -                                      | 8   | V <sub>OUT_C</sub> |                    |   |
| -                                      | -                                      | 14  | V <sub>OUT_D</sub> |                    |   |
| 1, 5, 8                                | -                                      | -   | NC                 | -                  | No internal connection  |
| PD                                     | PD                                     | -   | PD                 | -                  | Thermal Pad - TDFN package only.<br>Connect thermal pad to ground or most negative potential. |

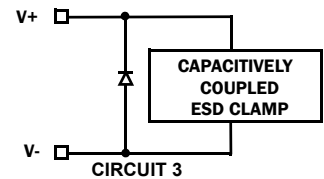
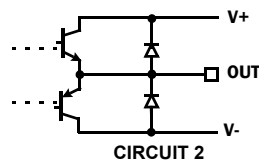
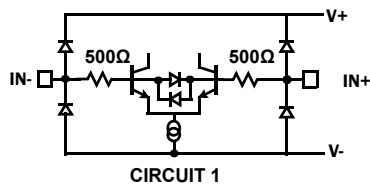

## Absolute Maximum Ratings

|  |                        |
|--|------------------------|
| Maximum Supply Voltage                             | 42V                    |
| Maximum Supply Voltage ISL28417SEH (Note 12)       | 40V                    |
| Maximum Differential Input Current                 | 20mA                   |
| Maximum Differential Input Voltage                 | 42V                    |
| Maximum Differential Input Voltage (ISL28417SEH)   | 20V                    |
| Min/Max Input Voltage                              | V- - 0.5V to V+ + 0.5V |
| Max/Min Input Current for Input Voltage >V+ or <V- | ±20mA                  |
| Output Short-Circuit Duration (1 output at a time) | Indefinite             |
| ESD Rating   |                        |
| Human Body Model                                   |                        |
| ISL28117, ISL28417                                 | 6kV                    |
| ISL28217   | 4.5kV                  |
| ISL28217 MSOP                                      | 5.5kV                  |
| ISL28417SEH  | 2kV                    |
| Charged Device Model                               |                        |
| ISL28117, ISL28217                                 | 1.5kV                  |
| ISL28217 (MSOP), ISL28417                          | 2kV                    |
| ISL28417SEH  | 1kV                    |
| Machine Model                                      |                        |
| ISL28117, ISL28217 (MSOP)                          | 300V                   |
| ISL28217   | 500V                   |
| ISL28417, ISL28417SEH                              | 450V                   |

CAUTION: Do not operate at or near the maximum ratings listed for extended periods of time. Exposure to such conditions can adversely impact product reliability and result in failures not covered by warranty.

### NOTES:

6.  $\theta_{JA}$  is measured with the component mounted on a high effective thermal conductivity test board in free air. See [TB379](#) for details.
7.  $\theta_{JA}$  is measured in free air with the component mounted on a high effective thermal conductivity test board with "direct attach" features. See [TB379](#).
8. For  $\theta_{JC}$ , the "case temp" location is the center of the exposed metal pad on the package underside.
9. For  $\theta_{JC}$ , the "case temp" location is taken at the package top center.
10.  $\theta_{JA}$  is measured with the component mounted on a low effective thermal conductivity test board in free air. See [TB379](#) for details.
11. For  $\theta_{JC}$ , the "case temp" location is the center of the ceramic on the package underside.
12. No destructive single-event effects at effective LET of 73.9MeV • cm<sup>2</sup>/mg up to a supply of ±20V. Reference manufacturers SEE report.

## Thermal Information

| Thermal Resistance (Typical)                        | $\theta_{JA}$ (°C/W)      | $\theta_{JC}$ (°C/W) |
|---|---------------------------|----------------------|
| 8 Ld SOIC ISL28117 (Notes 6, 9)                     | 120                       | 60                   |
| 8 Ld SOIC ISL28217 (Notes 6, 9)                     | 105                       | 50                   |
| 8 Ld MSOP ISL28117 (Notes 6, 9)                     | 155                       | 50                   |
| 8 Ld MSOP ISL28217 (Notes 6, 9)                     | 160                       | 55                   |
| 8 Ld TDFN ISL28117 (Notes 7, 8)                     | 48                        | 7                    |
| 8 Ld TDFN ISL28217 (Notes 7, 8)                     | 43                        | 2                    |
| 14 Ld SOIC (Notes 7, 9)                             | 73                        | 45                   |
| 14 Ld TSSOP (Notes 6, 9)                            | 90                        | 32                   |
| 14 Ld Flatpack (Notes 10, 11)                       | 105                       | 15                   |
| Maximum Storage Temperature Range                   | -65°C to +150°C           |                      |
| Maximum Junction Temperature (T <sub>JMAX</sub> )   | +150°C                    |                      |
| Pb-Free Reflow Profile (Non-Hermetic Packages Only) | see <a href="#">TB493</a> |                      |

## Recommended Operating Conditions

| Ambient Temperature Range (T <sub>A</sub> ) | ISL28117, ISL28217, ISL28417 | ISL28417SEH |
|---|------------------------------|-------------|
| ISL28117, ISL28217, ISL28417                | -40°C to +125°C              |             |
| ISL28417SEH                                 | -55°C to +125°C              |             |

**Electrical Specifications ISL28117, ISL28217, ISL28417 ( $V_S \pm 15V$ )**  $V_{CM} = 0, V_O = 0V, T_A = +25^\circ C$ , unless otherwise noted. **Boldface limits apply across the operating temperature range,  $-40^\circ C$  to  $+125^\circ C$ .**

| PARAMETER                          | DESCRIPTION   | TEST CONDITIONS                    | MIN<br>(Note 13) | TYP        | MAX<br>(Note 13) | UNIT             |
|------------------------------------|---|------------------------------------|------------------|------------|------------------|------------------|
| $V_{OS}$                           | Input Offset Voltage, SOIC, TSSOP Package   | ISL28x17 B Grade                   | -50              | 8          | 50               | $\mu V$          |
|                                    |   |                                    | <b>-110</b>      |            | <b>110</b>       | $\mu V$          |
|                                    |   | ISL28x17 C Grade                   | -100             | 4          | 100              | $\mu V$          |
|                                    |   |                                    | <b>-190</b>      |            | <b>190</b>       | $\mu V$          |
|                                    |   | ISL28417 B Grade                   | -70              | 10         | 70               | $\mu V$          |
|                                    |   |                                    | <b>-120</b>      |            | <b>120</b>       | $\mu V$          |
|                                    | ISL28417 C Grade<br>$T_A = -40^\circ C$ to $+85^\circ C$<br>$T_A = -40^\circ C$ to $+125^\circ C$ | -110                               | 10               | 110        | $\mu V$          |                  |
|                                    |   | -160                               |                  | 160        | $\mu V$          |                  |
|                                    |   | <b>-200</b>                        |                  | <b>200</b> | $\mu V$          |                  |
|                                    | Input Offset Voltage, MSOP Package  | ISL28117 B Grade                   | -70              | -10        | 70               | $\mu V$          |
|                                    |   |                                    | <b>-150</b>      |            | <b>150</b>       | $\mu V$          |
|                                    |   | ISL28117 C Grade                   | -150             | 4          | 150              | $\mu V$          |
|                                    |   |                                    | <b>-250</b>      |            | <b>250</b>       | $\mu V$          |
|                                    | ISL28217 C Grade  | -150                               | 10               | 150        | $\mu V$          |                  |
|                                    |   | <b>-250</b>                        |                  | <b>250</b> | $\mu V$          |                  |
| Input Offset Voltage, TDFN Package | ISL28117 B Grade  | -75                                | -10              | 75         | $\mu V$          |                  |
|                                    |   | <b>-160</b>                        |                  | <b>160</b> | $\mu V$          |                  |
|                                    | ISL28217 B Grade  | -70                                | 10               | 70         | $\mu V$          |                  |
|                                    |   | <b>-140</b>                        |                  | <b>140</b> | $\mu V$          |                  |
| ISL28x17 C Grade                   | -150  | 10                                 | 150              | $\mu V$    |                  |                  |
|                                    | <b>-250</b>   |                                    | <b>250</b>       | $\mu V$    |                  |                  |
| $TCV_{OS}$                         | Input Offset Voltage Temperature Coefficient; SOIC, TSSOP Package                                 | ISL28x17 B Grade                   | <b>-0.6</b>      | 0.14       | <b>0.6</b>       | $\mu V/^\circ C$ |
|                                    |   | ISL28x17 C Grade                   | <b>-0.9</b>      | 0.14       | <b>0.9</b>       | $\mu V/^\circ C$ |
|                                    |   | ISL28417 B Grade                   | <b>-0.75</b>     | 0.20       | <b>0.75</b>      | $\mu V/^\circ C$ |
|                                    |   | ISL28417 C Grade                   | <b>-0.9</b>      | 0.3        | <b>0.9</b>       | $\mu V/^\circ C$ |
|                                    | Input Offset Voltage Temperature Coefficient; MSOP Package  | ISL28117 B Grade                   | <b>-0.8</b>      | 0.1        | <b>0.8</b>       | $\mu V/^\circ C$ |
|                                    |   | ISL28117 C Grade                   | <b>-1</b>        | 0.14       | <b>1</b>         | $\mu V/^\circ C$ |
|                                    |   | ISL28217 C Grade                   | <b>-1</b>        | 0.14       | <b>1</b>         | $\mu V/^\circ C$ |
|                                    | Input Offset Voltage Temperature Coefficient; TDFN Package  | ISL28117 B Grade                   | <b>-0.9</b>      | 0.1        | <b>0.9</b>       | $\mu V/^\circ C$ |
|                                    |   | ISL28217 B Grade                   | <b>-0.7</b>      | 0.1        | <b>0.7</b>       | $\mu V/^\circ C$ |
| ISL28x17 C Grade                   |   | <b>-1</b>                          | 0.1              | <b>1</b>   | $\mu V/^\circ C$ |                  |
| $I_B$                              | Input Bias Current  |                                    | -1               | 0.08       | 1                | nA               |
|                                    |   |                                    | <b>-1.5</b>      |            | <b>1.5</b>       | nA               |
| $TCI_B$                            | Input Bias Current Temperature Coefficient  |                                    | -5               | 1          | 5                | $\mu A/^\circ C$ |
| $I_{OS}$                           | Input Offset Current  |                                    | -1.50            | 0.08       | 1.50             | nA               |
|                                    |   |                                    | <b>-1.85</b>     |            | <b>1.85</b>      | nA               |
| $TCI_{OS}$                         | Input Offset Current Temperature Coefficient  |                                    | <b>-3</b>        | 0.42       | <b>3</b>         | $\mu A/^\circ C$ |
|                                    |   | ISL28417 SOIC, TSSOP B and C Grade | <b>-4.00</b>     | 0.45       | <b>4.00</b>      | $\mu A/^\circ C$ |
| $V_{CM}$                           | Input Voltage Range   | Guaranteed by CMRR test            | <b>-13</b>       |            | <b>13</b>        | V                |
| CMRR                               | Common-Mode Rejection Ratio   | $V_{CM} = -13V$ to $+13V$          | 120              | 145        |                  | dB               |
|                                    |   |                                    | <b>120</b>       |            |                  | dB               |
| PSRR                               | Power Supply Rejection Ratio  | $V_S = \pm 2.25V$ to $\pm 20V$     | 120              | 145        |                  | dB               |
|                                    |   |                                    | <b>120</b>       |            |                  | dB               |

**Electrical Specifications ISL28117, ISL28217, ISL28417 ( $V_S \pm 15V$ )**  $V_{CM} = 0, V_O = 0V, T_A = +25^\circ C$ , unless otherwise noted. **Boldface limits apply across the operating temperature range,  $-40^\circ C$  to  $+125^\circ C$ .** (Continued)

| PARAMETER                  | DESCRIPTION  | TEST CONDITIONS   | MIN<br>(Note 13)             | TYP          | MAX<br>(Note 13)           | UNIT           |
|----------------------------|--|---|------------------------------|--------------|----------------------------|----------------|
| $A_{VOL}$                  | Open-Loop Gain                                       | $V_O = -13V$ to $+13V, R_L = 10k\Omega$ to ground             | 130                          | 143          |                            | dB             |
| $V_{OH}$                   | Output Voltage High                                  | $R_L = 10k\Omega$ to ground                                   | 13.5                         | 13.7         |                            | V              |
|                            |  |   | <b>13.2</b>                  |              |                            | V              |
|                            |  | $R_L = 2k\Omega$ to ground                                    | 13.30                        | 13.55        |                            | V              |
|                            |  |   | <b>13.1</b>                  |              |                            | V              |
| $V_{OL}$                   | Output Voltage Low                                   | $R_L = 10k\Omega$ to ground                                   |                              | -13.7        | -13.5                      | V              |
|                            |  |   |                              |              | <b>-13.2</b>               | V              |
|                            |  | $R_L = 2k\Omega$ to ground                                    |                              | -13.55       | -13.30                     | V              |
|                            |  |   |                              | <b>-13.1</b> | V                          |                |
| $I_S$                      | Supply Current/Amplifier                             |   |                              | 0.44         | 0.53                       | mA             |
|                            |  |   |                              |              | 0.68                       | mA             |
| $I_{SC}$                   | Short-Circuit  |   |                              | 43           |                            | mA             |
| $V_{SUPPLY}$               | Supply Voltage Range                                 | Guaranteed by PSRR  | <b><math>\pm 2.25</math></b> |              | <b><math>\pm 20</math></b> | V              |
| <b>AC SPECIFICATIONS</b>   |  |   |                              |              |                            |                |
| GBWP                       | Gain Bandwidth Product                               | $A_V = 1k, R_L = 2k\Omega$                                    |                              | 1.5          |                            | MHz            |
| $e_{nV_{p-p}}$             | Voltage Noise $V_{p-p}$                              | 0.1Hz to 10Hz   |                              | 0.25         |                            | $\mu V_{p-p}$  |
| $e_n$                      | Voltage Noise Density                                | $f = 10Hz$  |                              | 10           |                            | $nV/\sqrt{Hz}$ |
|                            |  | $f = 100Hz$   |                              | 8.2          |                            | $nV/\sqrt{Hz}$ |
|                            |  | $f = 1kHz$  |                              | 8            |                            | $nV/\sqrt{Hz}$ |
|                            |  | $f = 10kHz$   |                              | 8            |                            | $nV/\sqrt{Hz}$ |
| $i_n$                      | Current Noise Density                                | $f = 1kHz$  |                              | 0.1          |                            | $pA/\sqrt{Hz}$ |
| THD + N                    | Total Harmonic Distortion                            | 1kHz, $G = 1, V_O = 3.5V_{RMS}, R_L = 2k\Omega$               |                              | 0.0009       |                            | %              |
|                            |  | 1kHz, $G = 1, V_O = 3.5V_{RMS}, R_L = 10k\Omega$              |                              | 0.0005       |                            | %              |
| <b>TRANSIENT RESPONSE</b>  |  |   |                              |              |                            |                |
| SR                         | Slew Rate, $V_{OUT}$ 20% to 80%                      | $A_V = 11, R_L = 2k\Omega, V_O = 4V_{p-p}$                    |                              | 0.5          |                            | $V/\mu s$      |
| $t_r, t_f$<br>Small Signal | Rise Time<br>10% to 90% of $V_{OUT}$                 | $A_V = 1, V_{OUT} = 50mV_{p-p}, R_L = 10k\Omega$ to $V_{CM}$  |                              | 130          |                            | ns             |
|                            | Fall Time<br>90% to 10% of $V_{OUT}$                 | $A_V = 1, V_{OUT} = 50mV_{p-p}, R_L = 10k\Omega$ to $V_{CM}$  |                              | 130          |                            | ns             |
| $t_s$                      | Settling Time to 0.1%<br>10V Step; 10% to $V_{OUT}$  | $A_V = -1, V_{OUT} = 10V_{p-p}, R_L = 5k\Omega$ to $V_{CM}$   |                              | 21           |                            | $\mu s$        |
|                            | Settling Time to 0.01%<br>10V Step; 10% to $V_{OUT}$ | $A_V = -1, V_{OUT} = 10V_{p-p}, R_L = 5k\Omega$ to $V_{CM}$   |                              | 24           |                            | $\mu s$        |
|                            | Settling Time to 0.1%<br>4V Step; 10% to $V_{OUT}$   | $A_V = -1, V_{OUT} = 4V_{p-p}, R_L = 5k\Omega$ to $V_{CM}$    |                              | 13           |                            | $\mu s$        |
|                            | Settling Time to 0.01%<br>4V Step; 10% to $V_{OUT}$  | $A_V = -1, V_{OUT} = 4V_{p-p}, R_L = 5k\Omega$ to $V_{CM}$    |                              | 18           |                            | $\mu s$        |
| $t_{OL}$                   | Output Positive Overload Recovery Time               | $A_V = -100, V_{IN} = 0.2V_{p-p}, R_L = 2k\Omega$ to $V_{CM}$ |                              | 5.6          |                            | $\mu s$        |
|                            | Output Negative Overload Recovery Time               | $A_V = -100, V_{IN} = 0.2V_{p-p}, R_L = 2k\Omega$ to $V_{CM}$ |                              | 10.6         |                            | $\mu s$        |

**Electrical Specifications ISL28117, ISL28217, ISL28417 ( $V_S \pm 5V$ )**

$V_{CM} = 0$ ,  $V_O = 0V$ ,  $T_A = +25^\circ C$ , unless otherwise noted. **Boldface limits apply across the operating temperature range,  $-40^\circ C$  to  $+125^\circ C$ .**

| PARAMETER  | DESCRIPTION                                  | TEST CONDITIONS   | MIN<br>(Note 13) | TYP          | MAX<br>(Note 13) | UNIT          |                  |
|--|--|---|------------------|--------------|------------------|---------------|------------------|
| $V_{OS}$   | Input Offset Voltage, SOIC, TSSOP Package    | ISL28x17 B Grade  | -50              | 8            | 50               | $\mu V$       |                  |
|  |  |   | <b>-110</b>      |              | <b>110</b>       | $\mu V$       |                  |
|  |  | ISL28x17 C Grade  | -100             | 4            | 100              | $\mu V$       |                  |
|  |  |   | <b>-190</b>      |              | <b>190</b>       | $\mu V$       |                  |
|  |  | ISL28417 B Grade  | -70              | 10           | 70               | $\mu V$       |                  |
|  |  |   | <b>-120</b>      |              | <b>120</b>       | $\mu V$       |                  |
|  |  | ISL28417 C Grade<br>$T_A = -40^\circ C$ to $+85^\circ C$<br>$T_A = -40^\circ C$ to $+125^\circ C$ | -110             | 10           | 110              | $\mu V$       |                  |
|  |  |   | -160             |              | 160              | $\mu V$       |                  |
|  | Input Offset Voltage, MSOP Package           | ISL28117 B Grade  | -70              | -10          | 70               | $\mu V$       |                  |
|  |  |   | <b>-150</b>      |              | <b>150</b>       | $\mu V$       |                  |
|  |  | ISL28117 C Grade  | -150             | 4            | 150              | $\mu V$       |                  |
|  |  |   | <b>-250</b>      |              | <b>250</b>       | $\mu V$       |                  |
|  | Input Offset Voltage, TDFN Package           | ISL28117 B Grade  | -75              | -10          | 75               | $\mu V$       |                  |
|  |  |   | <b>-160</b>      |              | <b>160</b>       | $\mu V$       |                  |
|  |  | ISL28217 B Grade  | -70              | 10           | 70               | $\mu V$       |                  |
|  |  |   | <b>-140</b>      |              | <b>140</b>       | $\mu V$       |                  |
| ISL28x17 C Grade   | -150   | 10  | 150              | $\mu V$      |                  |               |                  |
|  | <b>-250</b>                                  |   | <b>250</b>       | $\mu V$      |                  |               |                  |
|  | $TCV_{OS}$                                   | Input Offset Voltage Temperature Coefficient; SOIC, TSSOP Package                                 | ISL28x17 B Grade | <b>-0.60</b> | 0.14             | <b>0.60</b>   | $\mu V/^\circ C$ |
|  |  |   | ISL28x17 C Grade | <b>-0.90</b> | 0.14             | <b>0.90</b>   | $\mu V/^\circ C$ |
| ISL28417 B Grade   | <b>-0.75</b>                                 |   | 0.20             | <b>0.75</b>  | $\mu V/^\circ C$ |               |                  |
| ISL28417 C Grade   | <b>-0.9</b>                                  |   | 0.3              | <b>0.9</b>   | $\mu V/^\circ C$ |               |                  |
| Input Offset Voltage Temperature Coefficient; MSOP Package | ISL28117 B Grade                             | <b>-0.8</b>   | 0.1              | <b>0.8</b>   | $\mu V/^\circ C$ |               |                  |
|  | ISL28117 C Grade                             | <b>-1</b>   | 0.14             | <b>1</b>     | $\mu V/^\circ C$ |               |                  |
|  | ISL28217 C Grade                             | <b>-1</b>   | 0.14             | <b>1</b>     | $\mu V/^\circ C$ |               |                  |
| Input Offset Voltage Temperature Coefficient; TDFN Package | ISL28117 B Grade                             | <b>-0.9</b>   | 0.1              | <b>0.9</b>   | $\mu V/^\circ C$ |               |                  |
|  | ISL28217 B Grade                             | <b>-0.7</b>   | 0.1              | <b>0.7</b>   | $\mu V/^\circ C$ |               |                  |
|  | ISL28x17 C Grade                             | <b>-1</b>   | 0.1              | <b>1</b>     | $\mu V/^\circ C$ |               |                  |
| $I_B$  | Input Bias Current                           | -1  | 0.18             | 1            | nA               |               |                  |
|  |  | <b>-1.5</b>   |                  | <b>1.5</b>   | nA               |               |                  |
| $TCI_B$  | Input Bias Current Temperature Coefficient   |   | <b>-5</b>        | 1            | <b>5</b>         | $pA/^\circ C$ |                  |
| $I_{OS}$   | Input Offset Current                         | -1.5  | 0.3              | 1.5          | nA               |               |                  |
|  |  | <b>-1.85</b>  |                  | <b>1.85</b>  | nA               |               |                  |
| $TCI_{OS}$   | Input Offset Current Temperature Coefficient | -3  | 0.42             | 3            | $pA/^\circ C$    |               |                  |
|  |  | ISL28417 SOIC, TSSOP B and C Grade  | <b>-4.00</b>     | 0.45         | <b>4.00</b>      | $pA/^\circ C$ |                  |
| $V_{CM}$   | Input Voltage Range                          |   | <b>-3</b>        |              | <b>3</b>         | V             |                  |
| CMRR   | Common-Mode Rejection Ratio                  | $V_{CM} = -3V$ to $+3V$   | 120              | 145          |                  | dB            |                  |
|  |  |   | <b>120</b>       |              |                  | dB            |                  |

**Electrical Specifications ISL28117, ISL28217, ISL28417 ( $V_S \pm 5V$ )** $V_{CM} = 0$ ,  $V_O = 0V$ ,  $T_A = +25^\circ C$ , unless otherwise noted. **Boldface limits apply across the operating temperature range,  $-40^\circ C$  to  $+125^\circ C$ .** (Continued)

| PARAMETER                    | DESCRIPTION   | TEST CONDITIONS  | MIN<br>(Note 13) | TYP   | MAX<br>(Note 13) | UNIT           |
|------------------------------|---|--|------------------|-------|------------------|----------------|
| PSRR                         | Power Supply Rejection Ratio                        | $V_S = \pm 2.25V$ to $\pm 5V$  | 120              | 145   |                  | dB             |
|                              |   |  | <b>120</b>       |       |                  | dB             |
| $A_{VOL}$                    | Open-Loop Gain                                      | $V_O = -3.0V$ to $+3.0V$ , $R_L = 10k\Omega$ to ground                 | 130              | 143   |                  | dB             |
| $V_{OH}$                     | Output Voltage High                                 | $R_L = 10k\Omega$ to ground  | 3.5              | 3.7   |                  | V              |
|                              |   |  | <b>3.2</b>       |       |                  | V              |
|                              |   | $R_L = 2k\Omega$ to ground   | 3.30             | 3.55  |                  | V              |
|                              |   |  | <b>3.1</b>       |       |                  | V              |
| $V_{OL}$                     | Output Voltage Low                                  | $R_L = 10k\Omega$ to ground  |                  | -3.7  | -3.5             | V              |
|                              |   |  |                  |       | <b>-3.2</b>      | V              |
|                              |   | $R_L = 2k\Omega$ to ground   |                  | -3.55 | -3.30            | V              |
|                              |   |  |                  |       | <b>-3.1</b>      | V              |
| $I_S$                        | Supply Current/Amplifier                            |  |                  | 0.44  | 0.53             | mA             |
|                              |   |  |                  |       | <b>0.68</b>      | mA             |
| $I_{SC}$                     | Short-Circuit                                       |  |                  | 43    |                  | mA             |
| <b>AC SPECIFICATIONS</b>     |   |  |                  |       |                  |                |
| GBWP                         | Gain Bandwidth Product                              | $A_V = 1k$ , $R_L = 2k\Omega$  |                  | 1.5   |                  | MHz            |
| $e_{np-p}$                   | Voltage Noise                                       | 0.1Hz to 10Hz  |                  | 0.25  |                  | $\mu V_{p-p}$  |
| $e_n$                        | Voltage Noise Density                               | $f = 10Hz$   |                  | 12    |                  | $nV/\sqrt{Hz}$ |
|                              |   | $f = 100Hz$  |                  | 8.6   |                  | $nV/\sqrt{Hz}$ |
|                              |   | $f = 1kHz$   |                  | 8     |                  | $nV/\sqrt{Hz}$ |
|                              |   | $f = 10kHz$  |                  | 8     |                  | $nV/\sqrt{Hz}$ |
| $i_n$                        | Current Noise Density                               | $f = 1kHz$   |                  | 0.1   |                  | $pA/\sqrt{Hz}$ |
| <b>TRANSIENT RESPONSE</b>    |   |  |                  |       |                  |                |
| SR                           | Slew Rate, $V_{OUT}$ 20% to 80%                     | $A_V = 11$ , $R_L = 2k\Omega$ $V_O = 4V_{p-p}$                         |                  | 0.5   |                  | $V/\mu s$      |
| $t_r$ , $t_f$ , Small Signal | Rise Time<br>10% to 90% of $V_{OUT}$                | $A_V = 1$ , $V_{OUT} = 50mV_{p-p}$ ,<br>$R_L = 10k\Omega$ to $V_{CM}$  |                  | 130   |                  | ns             |
|                              | Fall Time<br>90% to 10% of $V_{OUT}$                | $A_V = 1$ , $V_{OUT} = 50mV_{p-p}$ ,<br>$R_L = 10k\Omega$ to $V_{CM}$  |                  | 130   |                  | ns             |
| $t_s$                        | Settling Time to 0.1%<br>4V Step; 10% to $V_{OUT}$  | $A_V = -1$ , $V_{OUT} = 4V_{p-p}$ ,<br>$R_L = 5k\Omega$ to $V_{CM}$    |                  | 12    |                  | $\mu s$        |
|                              | Settling Time to 0.01%<br>4V Step; 10% to $V_{OUT}$ | $A_V = -1$ , $V_{OUT} = 4V_{p-p}$ ,<br>$R_L = 5k\Omega$ to $V_{CM}$    |                  | 19    |                  | $\mu s$        |
| $t_{OL}$                     | Output Positive Overload Recovery Time              | $A_V = -100$ , $V_{IN} = 0.2V_{p-p}$ ,<br>$R_L = 2k\Omega$ to $V_{CM}$ |                  | 7     |                  | $\mu s$        |
|                              | Output Negative Overload Recovery Time              | $A_V = -100$ , $V_{IN} = 0.2V_{p-p}$ ,<br>$R_L = 2k\Omega$ to $V_{CM}$ |                  | 5.8   |                  | $\mu s$        |

**Electrical Specifications ISL28417SEH ( $V_S \pm 15V$ )**  $V_{CM} = 0, V_O = 0V, T_A = +25^\circ C$ , unless otherwise noted. **Boldface limits apply across the  $-55^\circ C$  to  $+125^\circ C$  operating temperature range. The limits also define room temperature post-irradiation performance following  $^{60}Co$  irradiation at  $0.01rad(Si)/s$  to a total dose of  $50krad(Si)$  wafer-by-wafer acceptance.**

| PARAMETER                | DESCRIPTION                                  | CONDITIONS  | MIN<br>(Note 13)             | TYP         | MAX<br>(Note 13)           | UNIT             |
|--------------------------|--|---|------------------------------|-------------|----------------------------|------------------|
| $V_{OS}$                 | Input Offset Voltage                         |   |                              | 10          | 85                         | $\mu V$          |
|                          |  |   |                              |             | <b>110</b>                 | $\mu V$          |
| $TCV_{OS}$               | Offset Voltage Drift                         |   |                              | 0.1         | <b>1</b>                   | $\mu V/^\circ C$ |
| $I_{IB}$                 | Input Bias Current                           |   | -2.5                         | 0.08        | 2.5                        | nA               |
|                          |  | $T_A = -55^\circ C, +125^\circ C$                 | -5                           |             | 5                          | nA               |
|                          |  | $T_A = +25^\circ C$ , post radiation              | -15                          |             | 15                         | nA               |
| $TCI_{IB}$               | Input Bias Current Temperature Coefficient   |   | <b>-5</b>                    | <b>1</b>    | <b>5</b>                   | $pA/^\circ C$    |
| $I_{OS}$                 | Input Offset Current                         |   | -2.50                        | 0.08        | 2.50                       | nA               |
|                          |  | $T_A = -55^\circ C, +125^\circ C$                 | -3                           |             | 3                          | nA               |
|                          |  | $T_A = +25^\circ C$ , post radiation              | -6                           |             | 6                          | nA               |
| $TCI_{OS}$               | Input Offset Current Temperature Coefficient |   | <b>-3</b>                    | <b>0.42</b> | <b>3</b>                   | $pA/^\circ C$    |
| $V_{CM}$                 | Input Voltage Range                          | Guaranteed by CMRR test                           | <b>-13</b>                   |             | <b>13</b>                  | V                |
| CMRR                     | Common-Mode Rejection Ratio                  | $V_{CM} = -13V$ to $+13V$                         | 120                          | 145         |                            | dB               |
|                          |  |   | <b>120</b>                   |             |                            | dB               |
| PSRR                     | Power Supply Rejection Ratio                 | $V_S = \pm 2.25V$ to $\pm 20V$                    | 120                          | 145         |                            | dB               |
|                          |  |   | <b>120</b>                   |             |                            | dB               |
| $A_{VOL}$                | Open-Loop Gain                               | $V_O = -13V$ to $+13V, R_L = 10k\Omega$ to ground | 3,000                        | 14,000      |                            | V/mV             |
| $V_{OH}$                 | Output Voltage High                          | $R_L = 10k\Omega$ to ground                       | 13.5                         | 13.7        |                            | V                |
|                          |  |   | <b>13.2</b>                  |             |                            | V                |
|                          |  | $R_L = 2k\Omega$ to ground                        | 13.30                        | 13.55       |                            | V                |
|                          |  |   | <b>13.0</b>                  |             |                            | V                |
| $V_{OL}$                 | Output Voltage Low                           | $R_L = 10k\Omega$ to ground                       |                              | -13.7       | -13.5                      | V                |
|                          |  |   |                              |             | <b>-13.2</b>               | V                |
|                          |  | $R_L = 2k\Omega$ to ground                        |                              | -13.55      | -13.30                     | V                |
|                          |  |   |                              |             | <b>-13.0</b>               | V                |
| $I_S$                    | Supply Current/Amplifier                     |   |                              | 0.44        | 0.53                       | mA               |
|                          |  |   |                              |             | <b>0.68</b>                | mA               |
| $I_{SC}$                 | Short-Circuit Current                        |   |                              | 43          |                            | mA               |
| $V_{SUPPLY}$             | Supply Voltage Range                         | Guaranteed by PSRR                                | <b><math>\pm 2.25</math></b> |             | <b><math>\pm 20</math></b> | V                |
| <b>AC SPECIFICATIONS</b> |  |   |                              |             |                            |                  |
| GBWP                     | Gain Bandwidth Product                       | $A_V = 1k, R_L = 2k\Omega$                        |                              | 1.5         |                            | MHz              |
| $e_{nV_{p-p}}$           | Voltage Noise $V_{p-p}$                      | 0.1Hz to 10Hz                                     |                              | 0.25        |                            | $\mu V_{p-p}$    |
| $e_n$                    | Voltage Noise Density                        | $f = 10Hz$  |                              | 10          |                            | $nV/\sqrt{Hz}$   |
|                          |  | $f = 100Hz$                                       |                              | 8.2         |                            | $nV/\sqrt{Hz}$   |
|                          |  | $f = 1kHz$  |                              | 8           |                            | $nV/\sqrt{Hz}$   |
|                          |  | $f = 10kHz$                                       |                              | 8           |                            | $nV/\sqrt{Hz}$   |

**Electrical Specifications ISL28417SEH ( $V_S \pm 15V$ )**  $V_{CM} = 0$ ,  $V_O = 0V$ ,  $T_A = +25^\circ C$ , unless otherwise noted. **Boldface limits** apply across the  $-55^\circ C$  to  $+125^\circ C$  operating temperature range. The limits also define room temperature post-irradiation performance following  $^{60}Co$  irradiation at  $0.01rad(Si)/s$  to a total dose of  $50krad(Si)$  wafer-by-wafer acceptance. (Continued)

| PARAMETER                  | DESCRIPTION  | CONDITIONS  | MIN<br>(Note 13) | TYP    | MAX<br>(Note 13) | UNIT           |
|----------------------------|--|---|------------------|--------|------------------|----------------|
| in                         | Current Noise Density                                | $f = 1kHz$  |                  | 0.1    |                  | $pA/\sqrt{Hz}$ |
| THD + N                    | Total Harmonic Distortion                            | $1kHz, G = 1, V_O = 3.5VRMS, R_L = 2k\Omega$                              |                  | 0.0009 |                  | %              |
|                            |  | $1kHz, G = 1, V_O = 3.5VRMS, R_L = 10k\Omega$                             |                  | 0.0005 |                  | %              |
| <b>TRANSIENT RESPONSE</b>  |  |   |                  |        |                  |                |
| SR                         | Slew Rate, $V_{OUT}$ 20% to 80%                      | $A_V = 11, R_L = 2k\Omega, V_O = 4V_{P-P}$                                | 0.3              | 0.5    |                  | $V/\mu s$      |
|                            |  |   | <b>0.2</b>       |        |                  | $V/\mu s$      |
| $t_r, t_f$<br>Small Signal | Rise Time<br>10% to 90% of $V_{OUT}$                 | $A_V = 1, V_{OUT} = 50mV_{P-P}, R_L = 10k\Omega$ to $V_{CM}$              |                  | 130    | 450              | ns             |
|                            | Fall Time<br>90% to 10% of $V_{OUT}$                 | $A_V = 1, V_{OUT} = 50mV_{P-P}, R_L = 10k\Omega$ to $V_{CM}$              |                  | 130    | 600              | ns             |
| $t_s$                      | Settling Time to 0.1%<br>10V Step; 10% to $V_{OUT}$  | $A_V = -1, V_{OUT} = 10V_{P-P}, R_L = 5k\Omega$ to $V_{CM}$               |                  | 21     |                  | $\mu s$        |
|                            | Settling Time to 0.01%<br>10V Step; 10% to $V_{OUT}$ | $A_V = -1, V_{OUT} = 10V_{P-P}, R_L = 5k\Omega$ to $V_{CM}$               |                  | 24     |                  | $\mu s$        |
|                            | Settling Time to 0.1%<br>4V Step; 10% to $V_{OUT}$   | $A_V = -1, V_{OUT} = 4V_{P-P}, R_L = 5k\Omega$ to $V_{CM}$                |                  | 13     |                  | $\mu s$        |
|                            | Settling Time to 0.01%<br>4V Step; 10% to $V_{OUT}$  | $A_V = -1, V_{OUT} = 4V_{P-P}, R_L = 5k\Omega$ to $V_{CM}$                |                  | 18     |                  | $\mu s$        |
| $t_{OL}$                   | Output Positive Overload Recovery Time               | $A_V = -100, V_{IN} = 0.2V_{P-P}, R_L = 2k\Omega$ to $V_{CM}$             |                  | 5.6    |                  | $\mu s$        |
|                            | Output Negative Overload Recovery Time               | $A_V = -100, V_{IN} = 0.2V_{P-P}, R_L = 2k\Omega$ to $V_{CM}$             |                  | 10.6   |                  | $\mu s$        |
| OS+                        | Positive Overshoot                                   | $A_V = 1, V_{OUT} = 10V_{P-P}, R_f = 0\Omega, R_L = 2k\Omega$ to $V_{CM}$ |                  | 15     |                  | %              |
|                            |  |   |                  |        | <b>33</b>        | %              |
| OS-                        | Negative Overshoot                                   | $A_V = 1, V_{OUT} = 10V_{P-P}, R_f = 0\Omega, R_L = 2k\Omega$ to $V_{CM}$ |                  | 15     |                  | %              |
|                            |  |   |                  |        | <b>33</b>        | %              |

**Electrical Specifications ISL28417SEH ( $V_S \pm 15V$ )**  $V_{CM} = 0$ ,  $V_O = 0V$ ,  $T_A = +25^\circ C$ , unless otherwise noted. **Boldface limits** apply across the  $-55^\circ C$  to  $+125^\circ C$  operating temperature range. The limits also define room temperature post-irradiation performance following  $^{60}Co$  irradiation at  $0.01rad(Si)/s$  to a total dose of  $50krad(Si)$  wafer-by-wafer acceptance.

| PARAMETER  | DESCRIPTION                                | TEST CONDITIONS                      | MIN<br>(Note 13) | TYP         | MAX<br>(Note 13) | UNIT             |
|------------|--|--------------------------------------|------------------|-------------|------------------|------------------|
| $V_{OS}$   | Input Offset Voltage                       |                                      |                  | 10          | 150              | $\mu V$          |
|            |  |                                      |                  |             | <b>250</b>       | $\mu V$          |
| $TCV_{OS}$ | Offset Voltage Drift                       |                                      |                  | 0.1         | <b>1</b>         | $\mu V/^\circ C$ |
| $I_{IB}$   | Input Bias Current                         |                                      | -2.50            | 0.18        | 2.50             | nA               |
|            |  | $T_A = -55^\circ C, +125^\circ C$    | -5               |             | 5                | nA               |
|            |  | $T_A = +25^\circ C$ , post radiation | -15              |             | 15               | nA               |
| $TCI_{IB}$ | Input Bias Current Temperature Coefficient |                                      | <b>-5</b>        | <b>1</b>    | <b>5</b>         | $pA/^\circ C$    |
| $I_{OS}$   | Input Offset Current                       |                                      | -2.5             | 0.3         | 2.5              | nA               |
|            |  | $T_A = -55^\circ C, +125^\circ C$    | -3               |             | 3                | nA               |
|            |  | $T_A = +25^\circ C$ , post radiation | <b>6</b>         | <b>0.42</b> | <b>6</b>         | nA               |

**Electrical Specifications ISL28417SEH ( $V_S \pm 5V$ )**  $V_{CM} = 0$ ,  $V_O = 0V$ ,  $T_A = +25^\circ C$ , unless otherwise noted. **Boldface limits** apply across the  $-55^\circ C$  to  $+125^\circ C$  operating temperature range. The limits also define room temperature post-irradiation performance following  $^{60}Co$  irradiation at  $0.01rad(Si)/s$  to a total dose of  $50krad(Si)$  wafer-by-wafer acceptance. (Continued)

| PARAMETER                     | DESCRIPTION   | TEST CONDITIONS   | MIN<br>(Note 13) | TYP         | MAX<br>(Note 13) | UNIT            |
|-------------------------------|---|---|------------------|-------------|------------------|-----------------|
| $T_{CIOS}$                    | Input Offset Current Temperature Coefficient        |   | <b>-3</b>        | <b>0.42</b> | <b>3</b>         | pA/ $^\circ C$  |
| $V_{CM}$                      | Input Voltage Range                                 |   | <b>-3</b>        |             | <b>3</b>         | V               |
| $CMRR$                        | Common-Mode Rejection Ratio                         | $V_{CM} = -3V$ to $+3V$   | 120              | 145         |                  | dB              |
|                               |   |   | <b>120</b>       |             |                  | dB              |
| $PSRR$                        | Power Supply Rejection Ratio                        | $V_S = \pm 2.25V$ to $\pm 5V$                                       | 120              | 145         |                  | dB              |
|                               |   |   | <b>120</b>       |             |                  | dB              |
| $A_{VOL}$                     | Open-Loop Gain                                      | $V_O = -3.0V$ to $+3.0V$<br>$R_L = 10k\Omega$ to ground             | 3,000            | 14,000      |                  | V/mV            |
| $V_{OH}$                      | Output Voltage High                                 | $R_L = 10k\Omega$ to ground   | 3.5              | 3.7         |                  | V               |
|                               |   |   | <b>3.2</b>       |             |                  | V               |
|                               |   | $R_L = 2k\Omega$ to ground  | 3.300            | 3.550       |                  | V               |
|                               |   |   | <b>3.0</b>       |             |                  | V               |
| $V_{OL}$                      | Output Voltage Low                                  | $R_L = 10k\Omega$ to ground   |                  | -3.7        | -3.5             | V               |
|                               |   |   |                  |             | <b>-3.2</b>      | V               |
|                               |   | $R_L = 2k\Omega$ to ground  |                  | -3.55       | -3.30            | V               |
|                               |   |   |                  |             | <b>-3.0</b>      | V               |
| $I_S$                         | Supply Current/Amplifier                            |   |                  | 0.44        | 0.53             | mA              |
|                               |   |   |                  |             | <b>0.68</b>      | mA              |
| $I_{SC}$                      | Short-Circuit Current                               |   |                  | 43          |                  | mA              |
| <b>AC SPECIFICATIONS</b>      |   |   |                  |             |                  |                 |
| GBWP                          | Gain Bandwidth Product                              | $A_V = 1k$ , $R_L = 2k\Omega$                                       |                  | 1.5         |                  | MHz             |
| $e_{np-p}$                    | Voltage Noise                                       | 0.1Hz to 10Hz   |                  | 0.25        |                  | $\mu V_{p-p}$   |
| $e_n$                         | Voltage Noise Density                               |   | $f = 10Hz$       |             | 12               | nV/ $\sqrt{Hz}$ |
|                               |   |   | $f = 100Hz$      |             | 8.6              | nV/ $\sqrt{Hz}$ |
|                               |   |   | $f = 1kHz$       |             | 8                | nV/ $\sqrt{Hz}$ |
|                               |   |   | $f = 10kHz$      |             | 8                | nV/ $\sqrt{Hz}$ |
| $i_n$                         | Current Noise Density                               | $f = 1kHz$  |                  | 0.1         |                  | pA/ $\sqrt{Hz}$ |
| <b>TRANSIENT RESPONSE</b>     |   |   |                  |             |                  |                 |
| SR                            | Slew Rate, $V_{OUT}$ 20% to 80%                     | $A_V = 11$ , $R_L = 2k\Omega$ , $V_O = 4V_{p-p}$                    |                  | 0.5         |                  | V/ $\mu s$      |
| $t_r$ , $t_f$<br>Small Signal | Rise Time<br>10% to 90% of $V_{OUT}$                | $A_V = 1$ , $V_{OUT} = 50mV_{p-p}$<br>$R_L = 10k\Omega$ to $V_{CM}$ |                  | 130         |                  | ns              |
|                               | Fall Time<br>90% to 10% of $V_{OUT}$                | $A_V = 1$ , $V_{OUT} = 50mV_{p-p}$<br>$R_L = 10k\Omega$ to $V_{CM}$ |                  | 130         |                  | ns              |
| $t_s$                         | Settling Time to 0.1%<br>4V Step; 10% to $V_{OUT}$  | $A_V = -1$ , $V_{OUT} = 4V_{p-p}$<br>$R_L = 5k\Omega$ to $V_{CM}$   |                  | 12          |                  | $\mu s$         |
|                               | Settling Time to 0.01%<br>4V Step; 10% to $V_{OUT}$ | $A_V = -1$ , $V_{OUT} = 4V_{p-p}$<br>$R_L = 5k\Omega$ to $V_{CM}$   |                  | 19          |                  | $\mu s$         |

**Electrical Specifications ISL28417SEH ( $V_S \pm 5V$ )**  $V_{CM} = 0, V_O = 0V, T_A = +25^\circ C$ , unless otherwise noted. **Boldface limits apply across the  $-55^\circ C$  to  $+125^\circ C$  operating temperature range. The limits also define room temperature post-irradiation performance following  $^{60}Co$  irradiation at  $0.01rad(Si)/s$  to a total dose of  $50krad(Si)$  wafer-by-wafer acceptance. (Continued)**

| PARAMETER | DESCRIPTION                            | TEST CONDITIONS   | MIN<br>(Note 13) | TYP | MAX<br>(Note 13) | UNIT    |
|-----------|--|---|------------------|-----|------------------|---------|
| $t_{OL}$  | Output Positive Overload Recovery Time | $A_V = -100, V_{IN} = 0.2V_{P-P}$<br>$R_L = 2k\Omega$ to $V_{CM}$             |                  | 7   |                  | $\mu s$ |
|           | Output Negative Overload Recovery Time | $A_V = -100, V_{IN} = 0.2V_{P-P}$<br>$R_L = 2k\Omega$ to $V_{CM}$             |                  | 5.8 |                  | $\mu s$ |
| OS+       | Positive Overshoot                     | $A_V = 1, V_{OUT} = 10V_{P-P}, R_f = 0\Omega$<br>$R_L = 2k\Omega$ to $V_{CM}$ |                  | 15  |                  | %       |
| OS-       | Negative Overshoot                     | $A_V = 1, V_{OUT} = 10V_{P-P}, R_f = 0\Omega$<br>$R_L = 2k\Omega$ to $V_{CM}$ |                  | 15  |                  | %       |

NOTE:

13. Compliance to datasheet limits is assured by one or more methods: production test, characterization and/or design.

**Typical Performance Curves**  $V_S = \pm 15V, V_{CM} = 0V, R_L = \text{Open}$ , unless otherwise specified.

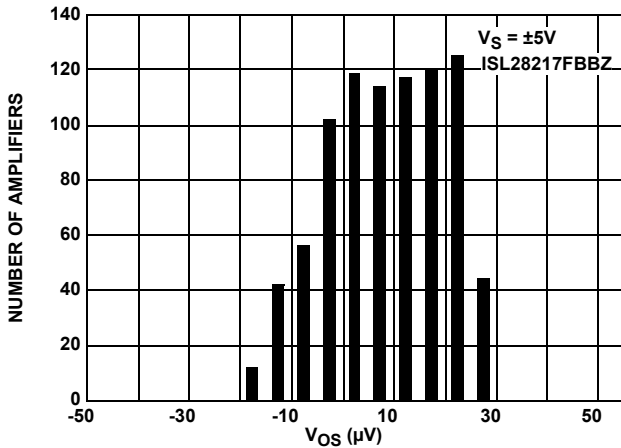

FIGURE 3.  $V_{OS}$  DISTRIBUTION FOR GRADE B

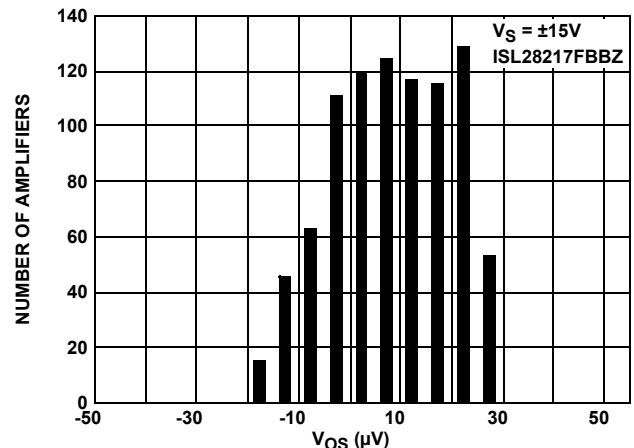

FIGURE 4.  $V_{OS}$  DISTRIBUTION FOR GRADE B

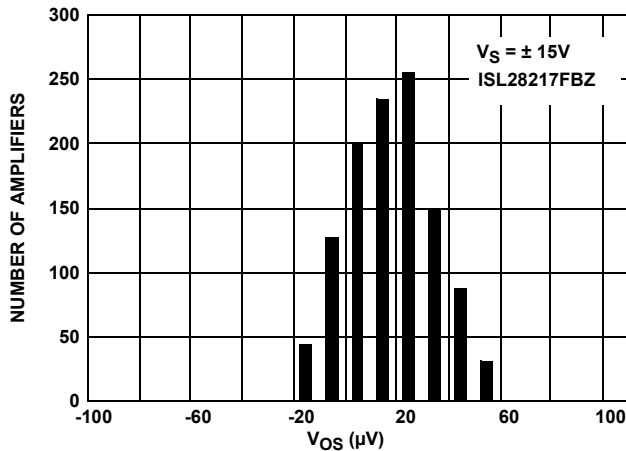

FIGURE 5.  $V_{OS}$  DISTRIBUTION FOR GRADE C

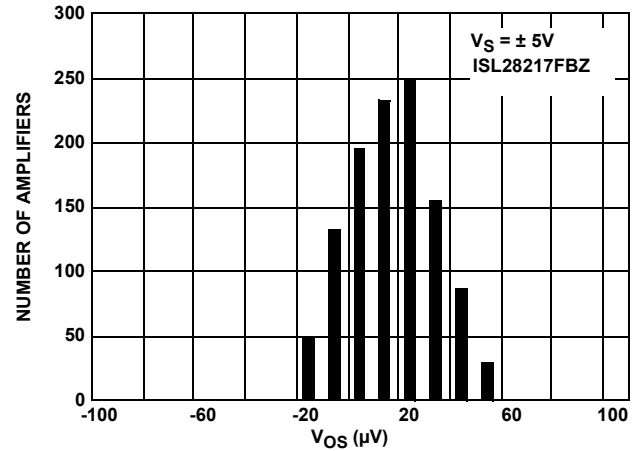

FIGURE 6.  $V_{OS}$  DISTRIBUTION FOR GRADE C

# Typical Performance Curves

$V_S = \pm 15V$ ,  $V_{CM} = 0V$ ,  $R_L = \text{Open}$ , unless otherwise specified. (Continued)

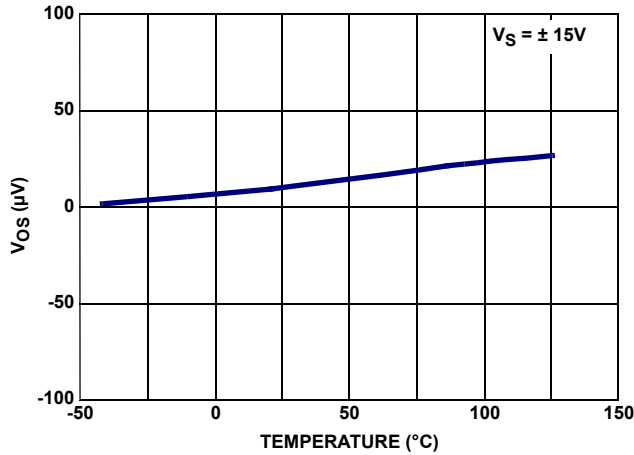

FIGURE 7.  $V_{OS}$  RANGE vs TEMPERATURE

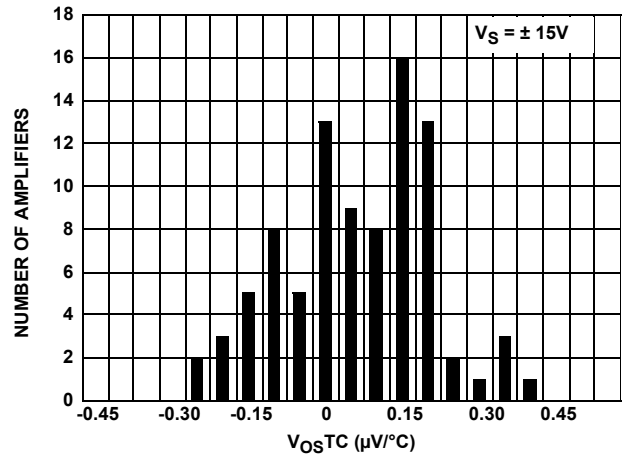

FIGURE 8.  $TCV_{OS}$  vs NUMBER OF AMPLIFIERS

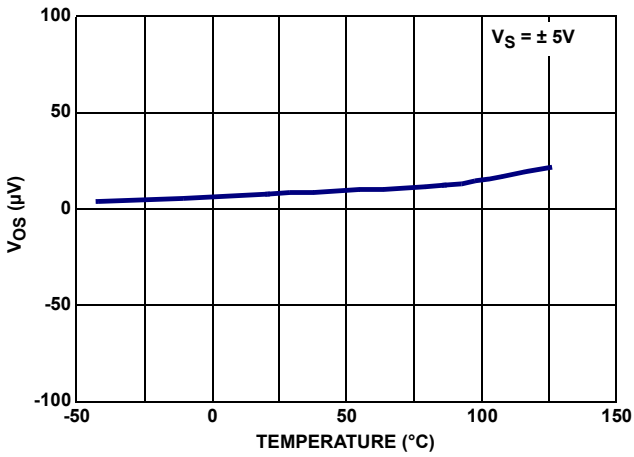

FIGURE 9.  $V_{OS}$  RANGE vs TEMPERATURE

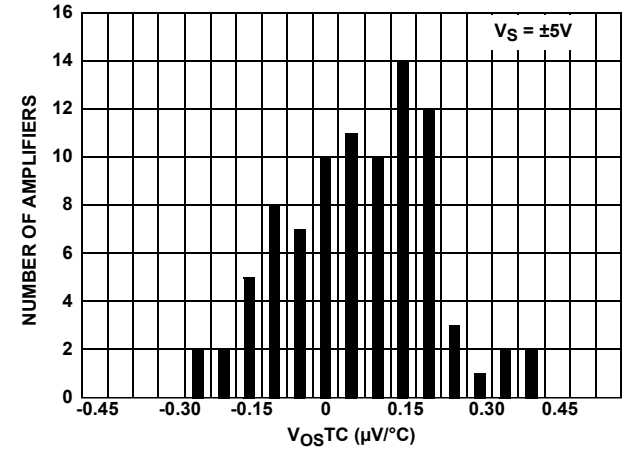

FIGURE 10.  $TCV_{OS}$  vs NUMBER OF AMPLIFIERS

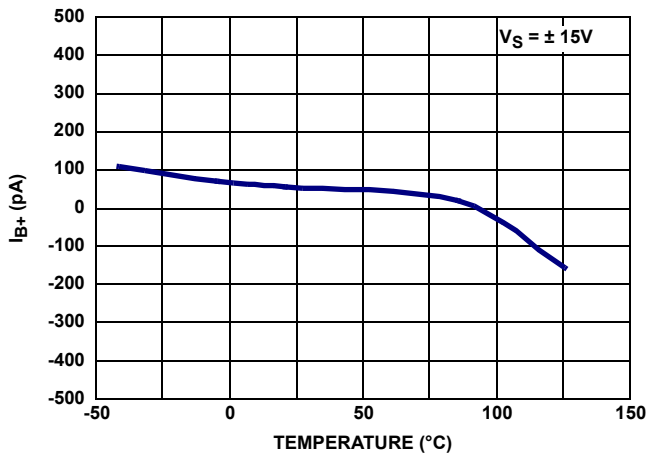

FIGURE 11.  $I_{B+}$  RANGE vs TEMPERATURE

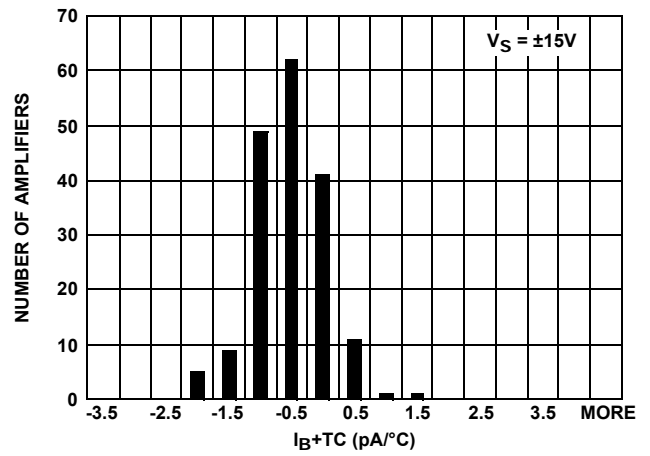

FIGURE 12.  $TCI_{B+}$  vs NUMBER OF AMPLIFIERS

# Typical Performance Curves

$V_S = \pm 15V, V_{CM} = 0V, R_L = \text{Open}$ , unless otherwise specified. (Continued)

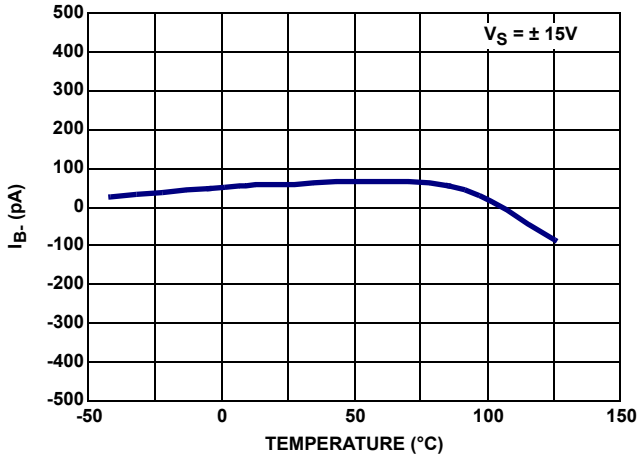

FIGURE 13.  $I_{B-}$  RANGE vs TEMPERATURE

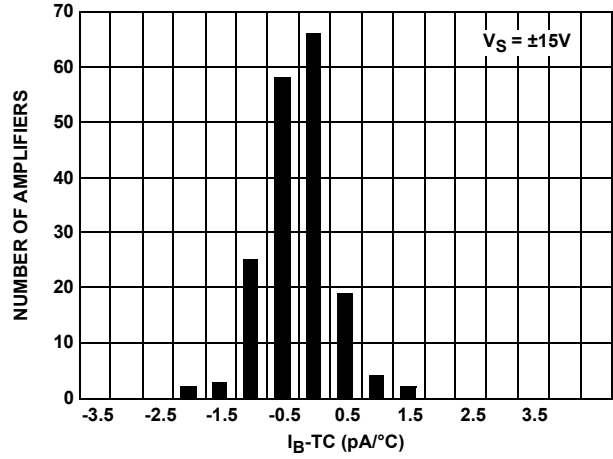

FIGURE 14.  $TCI_{B-}$  vs NUMBER OF AMPLIFIERS

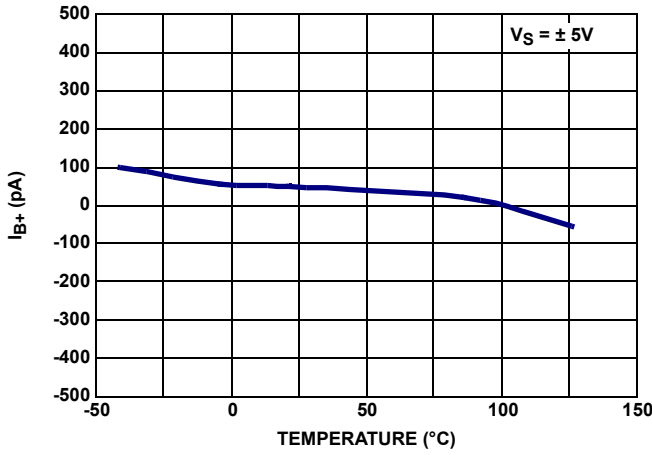

FIGURE 15.  $I_{B+}$  RANGE vs TEMPERATURE

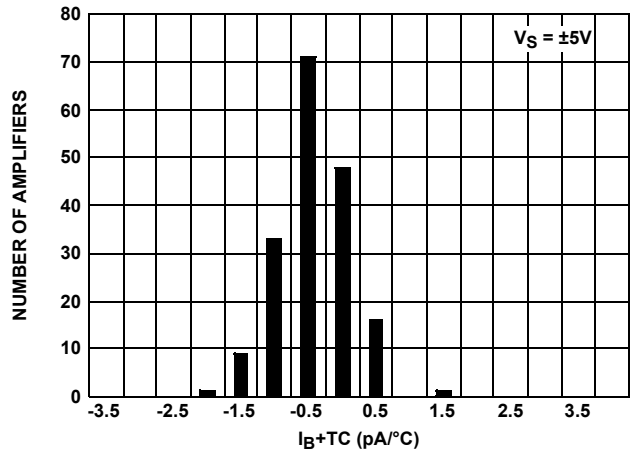

FIGURE 16.  $TCI_{B+}$  vs NUMBER OF AMPLIFIERS

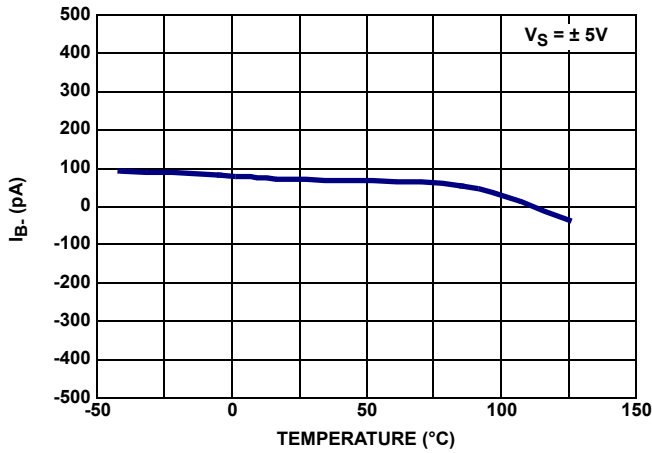

FIGURE 17.  $I_{B-}$  RANGE vs TEMPERATURE

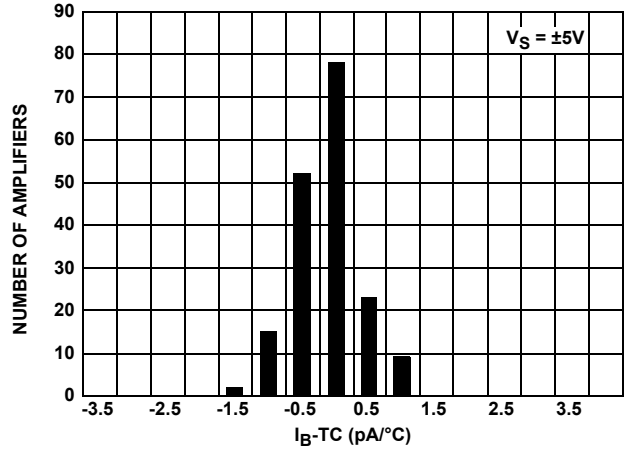

FIGURE 18.  $TCI_{B-}$  vs NUMBER OF AMPLIFIERS

# Typical Performance Curves

$V_S = \pm 15V, V_{CM} = 0V, R_L = \text{Open}$ , unless otherwise specified. (Continued)

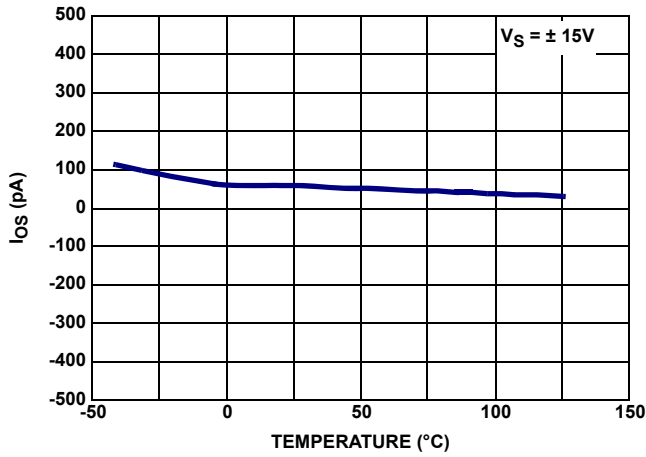

FIGURE 19.  $I_{OS}$  RANGE vs TEMPERATURE

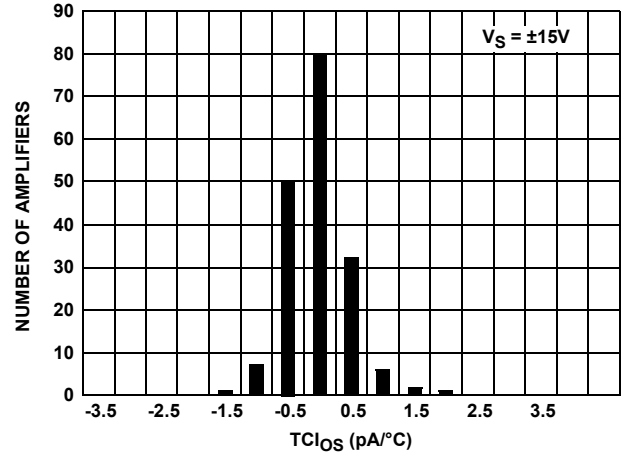

FIGURE 20.  $I_{OS}TC$  vs NUMBER OF AMPLIFIERS

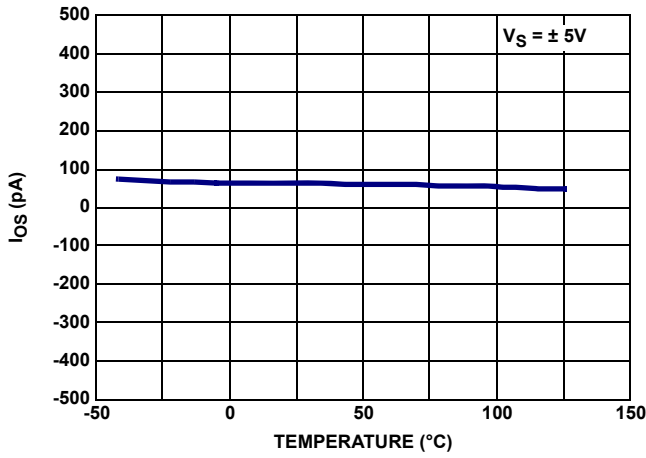

FIGURE 21.  $I_{OS}$  RANGE vs TEMPERATURE

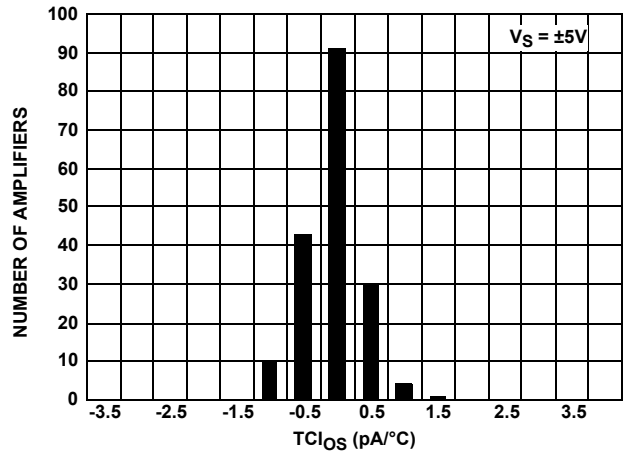

FIGURE 22.  $I_{OS}TC$  vs NUMBER OF AMPLIFIERS

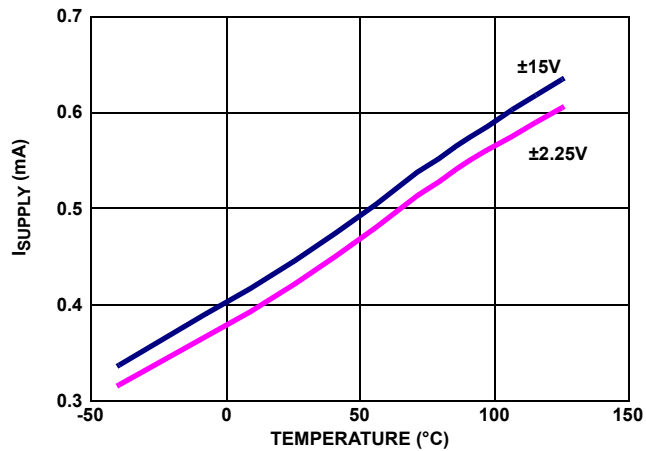

FIGURE 23. SUPPLY CURRENT PER AMPLIFIERS vs TEMPERATURE

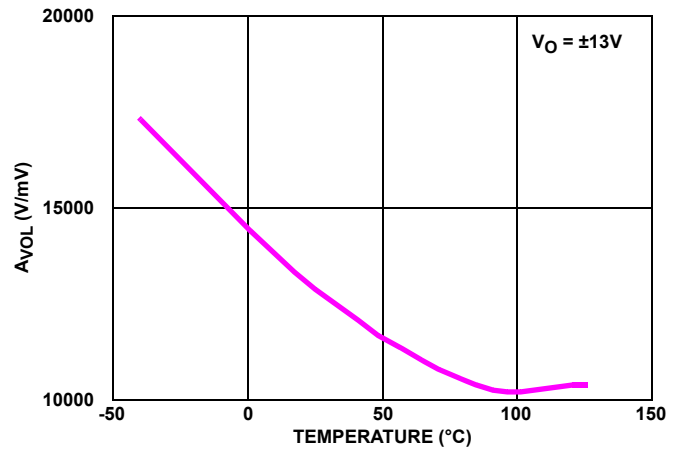

FIGURE 24.  $A_{VOL}$  vs TEMPERATURE

# Typical Performance Curves

$V_S = \pm 15V$ ,  $V_{CM} = 0V$ ,  $R_L = \text{Open}$ , unless otherwise specified. (Continued)

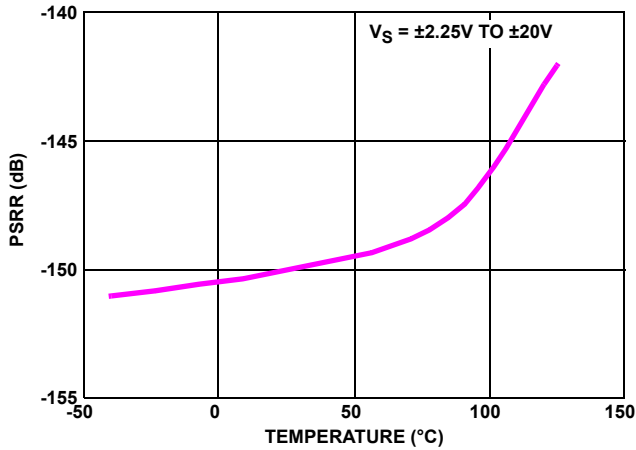

FIGURE 25. PSRR vs TEMPERATURE

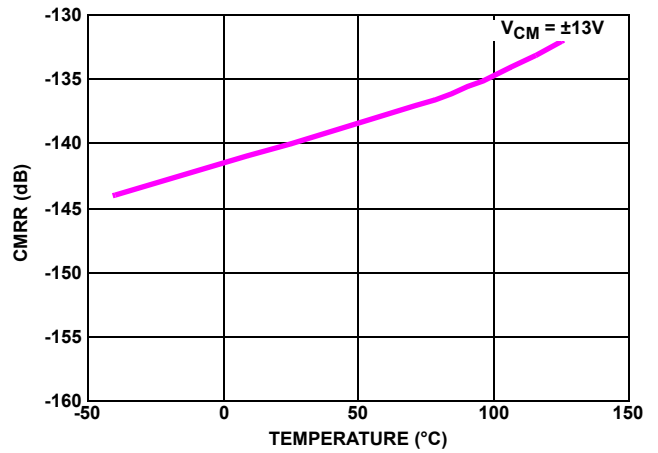

FIGURE 26. CMRR vs TEMPERATURE

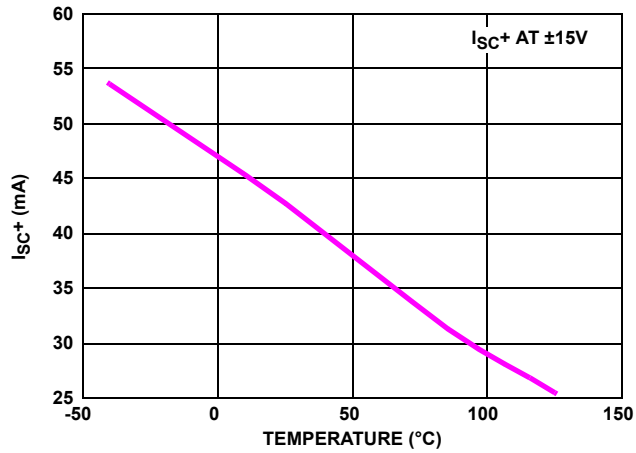

FIGURE 27. POSITIVE SHORT-CIRCUIT CURRENT vs TEMPERATURE

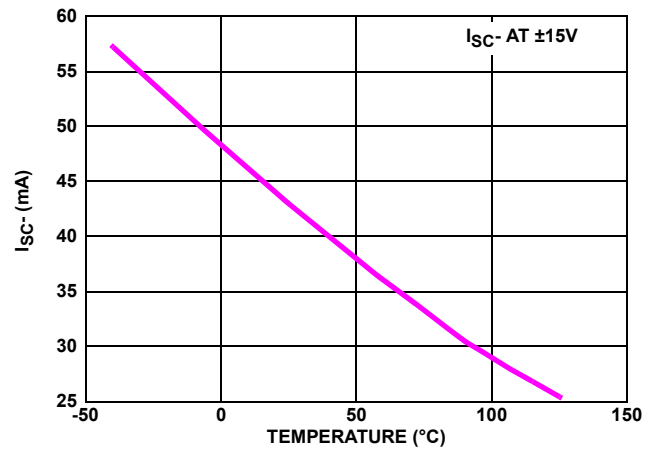

FIGURE 28. NEGATIVE SHORT-CIRCUIT CURRENT vs TEMPERATURE

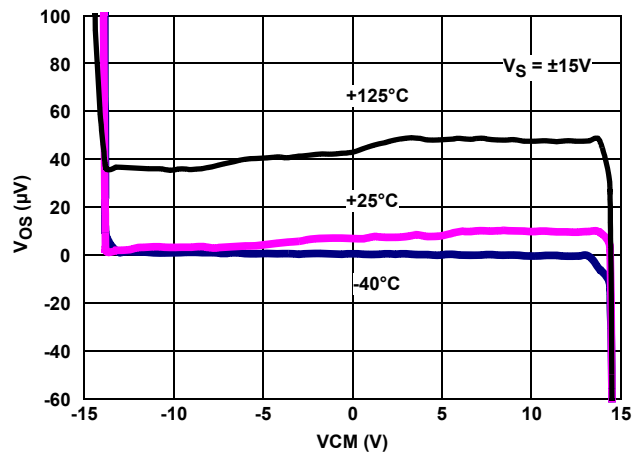

FIGURE 29. INPUT  $V_{OS}$  vs INPUT COMMON-MODE VOLTAGE,  $V_S = \pm 15V$

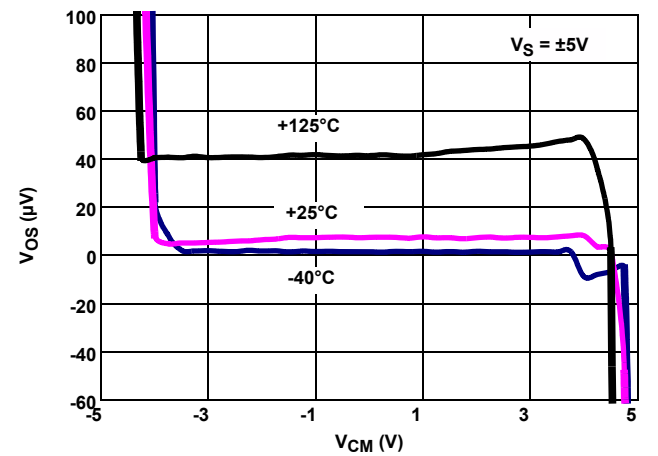

FIGURE 30. INPUT  $V_{OS}$  vs INPUT COMMON-MODE VOLTAGE,  $V_S = \pm 5V$

# Typical Performance Curves

$V_S = \pm 15V$ ,  $V_{CM} = 0V$ ,  $R_L = \text{Open}$ , unless otherwise specified. (Continued)

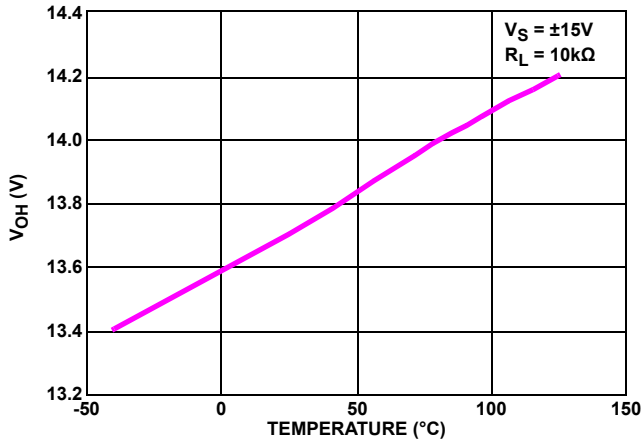

FIGURE 31.  $V_{OH}$  vs TEMPERATURE

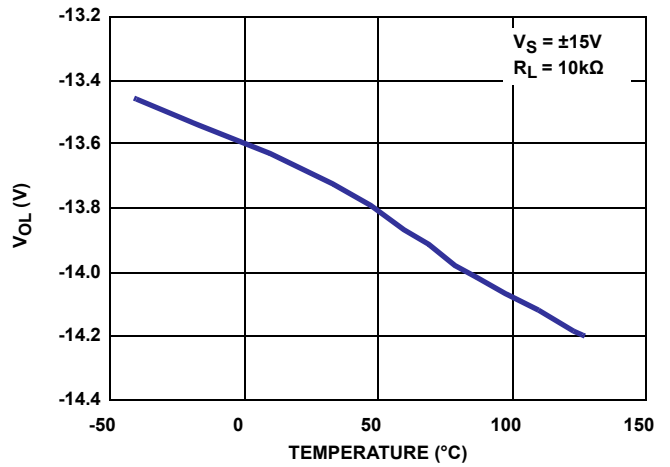

FIGURE 32.  $V_{OL}$  vs TEMPERATURE,

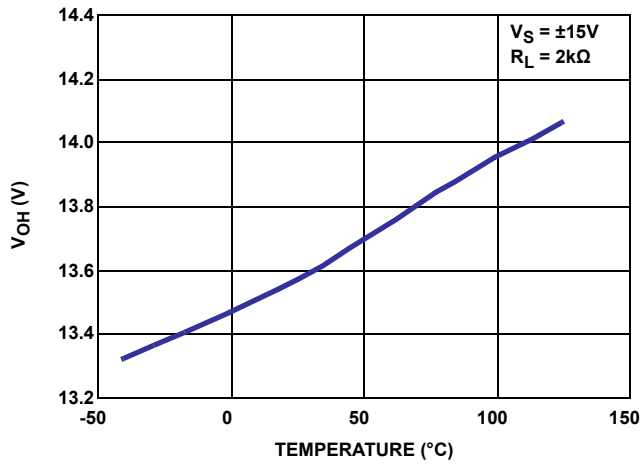

FIGURE 33.  $V_{OH}$  vs TEMPERATURE

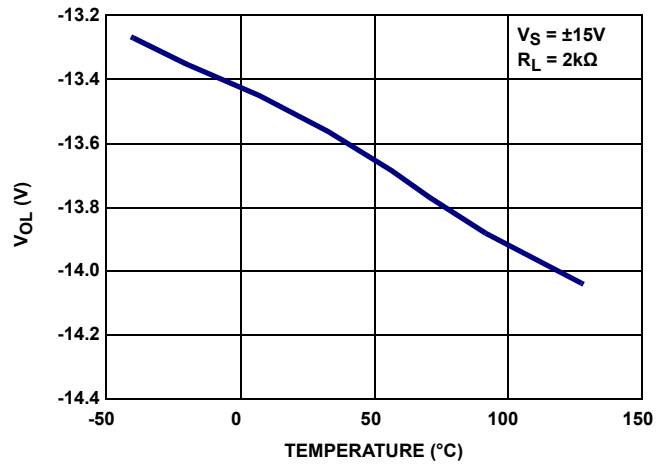

FIGURE 34.  $V_{OL}$  vs TEMPERATURE

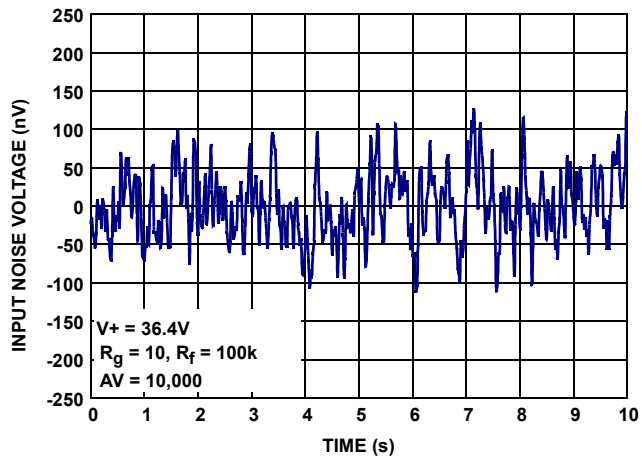

FIGURE 35. INPUT NOISE VOLTAGE 0.1Hz TO 10Hz

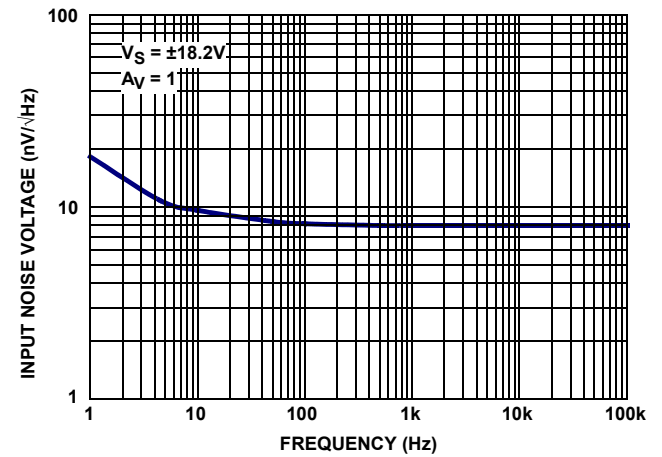

FIGURE 36. INPUT NOISE VOLTAGE SPECTRAL DENSITY

# Typical Performance Curves

$V_S = \pm 15V$ ,  $V_{CM} = 0V$ ,  $R_L = \text{Open}$ , unless otherwise specified. (Continued)

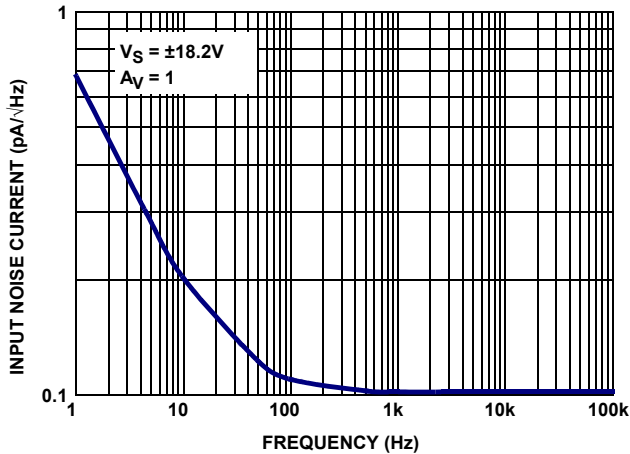

FIGURE 37. INPUT NOISE CURRENT SPECTRAL DENSITY

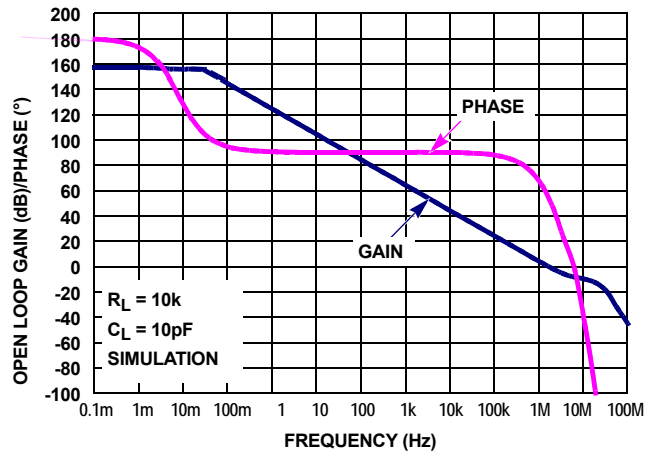

FIGURE 38. OPEN-LOOP GAIN, PHASE vs FREQUENCY,  $R_L = 10k\Omega$ ,  $C_L = 10pF$

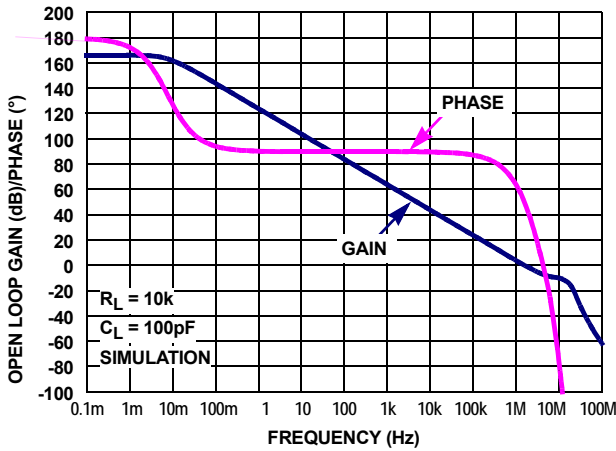

FIGURE 39. OPEN-LOOP GAIN, PHASE vs FREQUENCY,  $R_L = 10k\Omega$ ,  $C_L = 100pF$

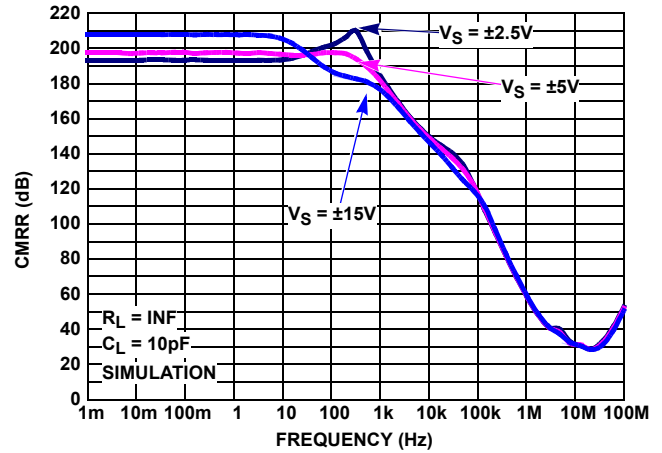

FIGURE 40. CMRR vs FREQUENCY,  $V_S = \pm 2.25, \pm 5V, \pm 15V$

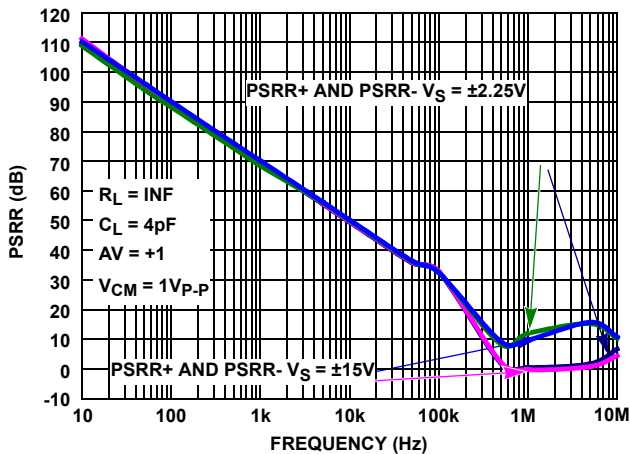

FIGURE 41. PSRR vs FREQUENCY,  $V_S = \pm 5V, \pm 15V$

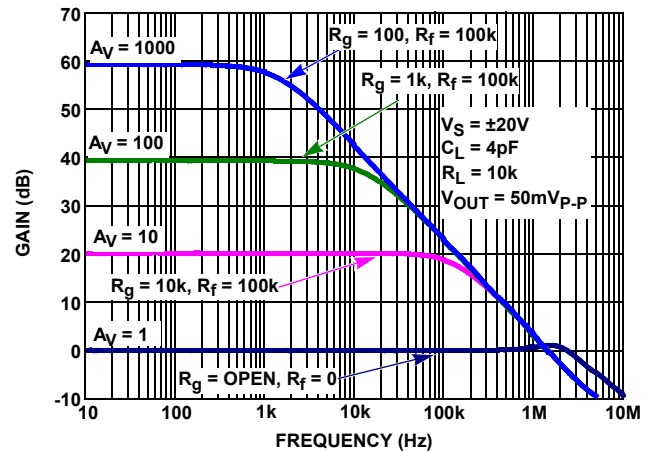

FIGURE 42. FREQUENCY RESPONSE vs CLOSED LOOP GAIN

# Typical Performance Curves

$V_S = \pm 15V, V_{CM} = 0V, R_L = \text{Open}$ , unless otherwise specified. (Continued)

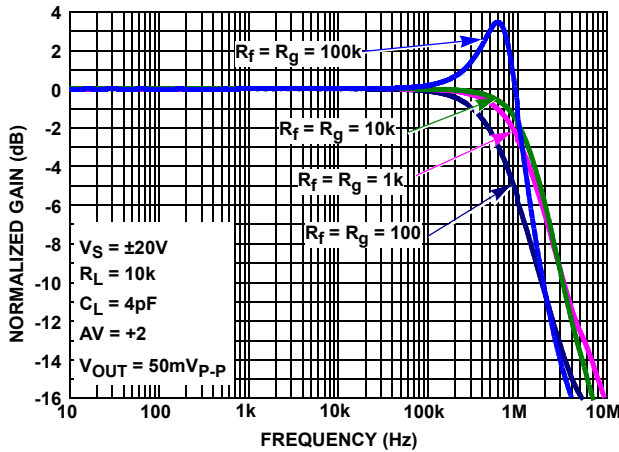

FIGURE 43. FREQUENCY RESPONSE vs FEEDBACK RESISTANCE  $R_f/R_g$

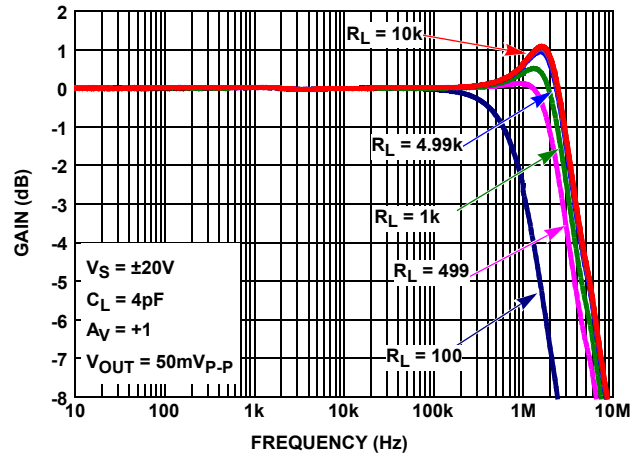

FIGURE 44. GAIN vs FREQUENCY vs  $R_L$

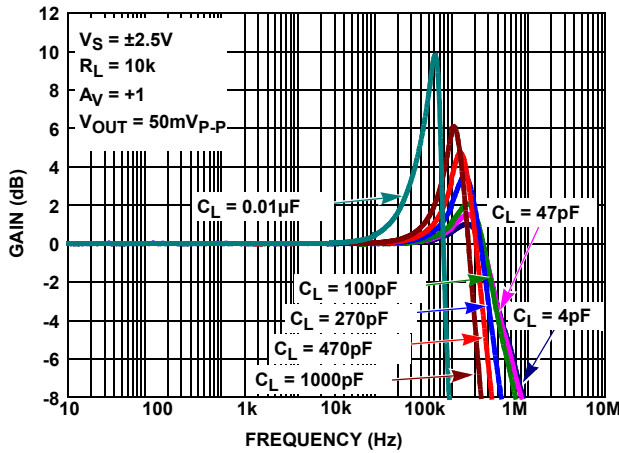

FIGURE 45. GAIN vs FREQUENCY vs  $C_L$

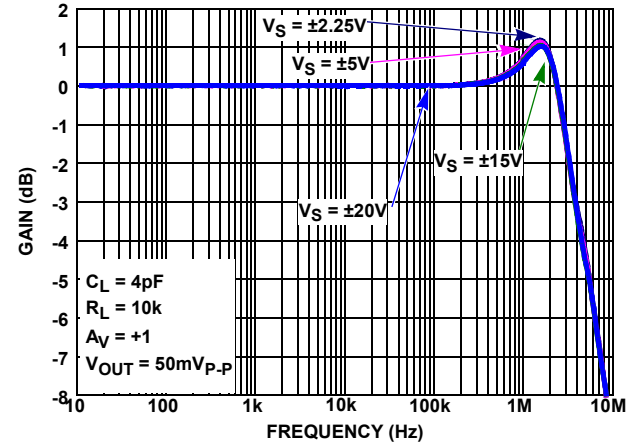

FIGURE 46. GAIN vs FREQUENCY vs SUPPLY VOLTAGE

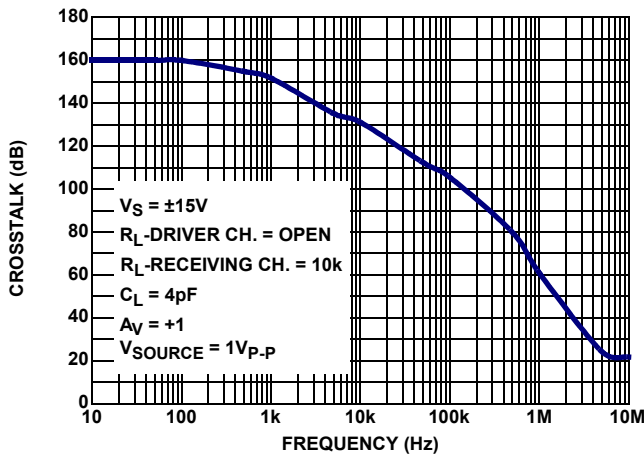

FIGURE 47. CROSSTALK,  $V_S = \pm 15V$

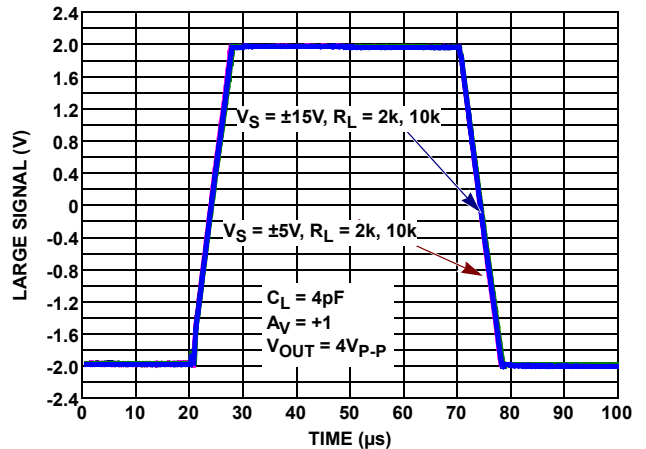

FIGURE 48. LARGE SIGNAL TRANSIENT RESPONSE vs  $R_L, V_S = \pm 5V, \pm 15V$

# Typical Performance Curves

$V_S = \pm 15V$ ,  $V_{CM} = 0V$ ,  $R_L = \text{Open}$ , unless otherwise specified. (Continued)

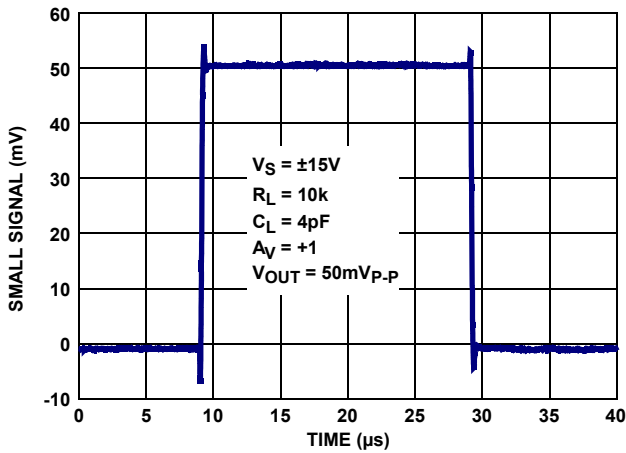

FIGURE 49. SMALL SIGNAL TRANSIENT RESPONSE,  $V_S = \pm 5V, \pm 15V$

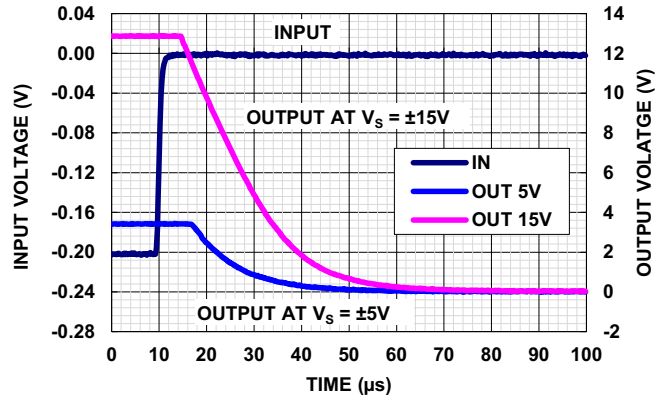

FIGURE 50. POSITIVE OUTPUT OVERLOAD RESPONSE TIME,  $V_S = \pm 5V, \pm 15V$ ,  $R_L = 2k$ ,  $C_L = 4pF$ ,  $A_V = -100$ ,  $R_f = 100k$ ,  $R_g = 1k$ ,  $V_{IN} = 200mV_{P-P}$

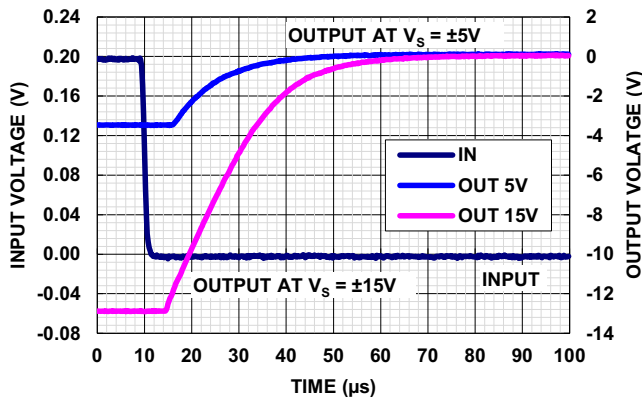

FIGURE 51. NEGATIVE OUTPUT OVERLOAD RESPONSE TIME,  $V_S = \pm 5V, \pm 15V$ ,  $R_L = 2k$ ,  $C_L = 4pF$ ,  $A_V = -100$ ,  $R_f = 100k$ ,  $R_g = 1k$ ,  $V_{IN} = 200mV_{P-P}$

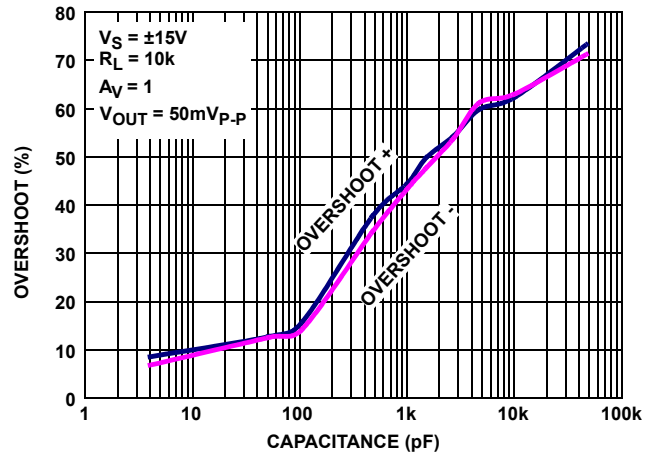

FIGURE 52. % OVERSHOOT vs LOAD CAPACITANCE,  $V_S = \pm 15V$

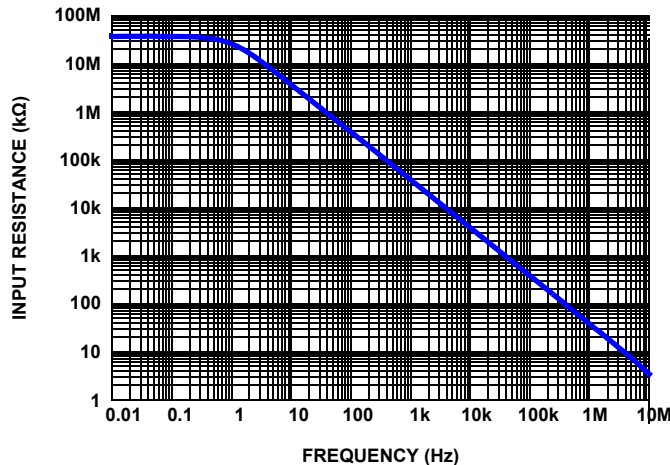

FIGURE 53. COMMON-MODE INPUT IMPEDANCE

## Applications Information

### Functional Description

The ISL28117, ISL28217, ISL28417, and ISL28417SEH are single, dual and quad, low noise precision op amps. Both devices are fabricated in a new precision 40V complementary bipolar DI process. A super-beta NPN input stage with input bias current cancellation provides low input bias current (180pA typical), low input offset voltage (13 $\mu$ V typical), low input noise voltage (8nV/ $\sqrt{\text{Hz}}$ ), and low 1/f noise corner frequency (~8Hz). These amplifiers also feature high open loop gain (18kV/mV) for excellent CMRR (145dB) and THD+N performance (0.0005% at 3.5V<sub>RMS</sub>, 1kHz into 2k $\Omega$ ). A complimentary bipolar output stage enables high capacitive load drive without external compensation.

### Operating Voltage Range

The devices are designed to operate across the 4.5V ( $\pm 2.25$ V) to 40V ( $\pm 20$ V) range and are fully characterized at 10V ( $\pm 5$ V) and 30V ( $\pm 15$ V). The Power Supply Rejection Ratio typically exceeds 140dB across the full operating voltage range and 120dB minimum across the -40 $^{\circ}$ C to +125 $^{\circ}$ C temperature range. The worst case common-mode input voltage range over-temperature is 2V to each rail. With  $\pm 15$ V supplies, CMRR performance is typically >130dB over-temperature. The minimum CMRR performance across the -40 $^{\circ}$ C to +125 $^{\circ}$ C temperature range is >120dB for power supply voltages from  $\pm 5$ V (10V) to  $\pm 15$ V (30V).

### Input Performance

The super-beta NPN input pair provides excellent frequency response while maintaining high input precision. High NPN beta (>1000) reduces input bias current while maintaining good frequency response, low input bias current and low noise. Input bias cancellation circuits provide additional bias current reduction to <1nA and excellent temperature stabilization. [Figures 11](#) through [18](#) show the high degree of bias current stability at  $\pm 5$ V and  $\pm 15$ V supplies that is maintained across the -40 $^{\circ}$ C to +125 $^{\circ}$ C temperature range. The low bias current TC also produces very low input offset current TC, which reduces DC input offset errors in precision, high impedance amplifiers.

The +25 $^{\circ}$ C maximum input offset voltage ( $V_{OS}$ ) for the "B" grade is 50 $\mu$ V and 100 $\mu$ V for the "C" grade. Input offset voltage temperature coefficients ( $V_{OSTC}$ ) are a maximum of  $\pm 0.6\mu\text{V}/^{\circ}\text{C}$  for the "B" and  $\pm 0.9\mu\text{V}/^{\circ}\text{C}$  for the "C" grade. [Figures 3](#) through [6](#) show the typical gaussian-like distribution over the  $\pm 5$ V to  $\pm 15$ V supply range and over the full temperature range. The  $V_{OS}$  temperature behavior is smooth ([Figures 7](#) through [10](#)) maintaining constant TC across the entire temperature range.

### Input ESD Diode Protection

The input terminals (IN+ and IN-) have internal ESD protection diodes to the positive and negative supply rails, series connected 500 $\Omega$  current limiting resistors and an anti-parallel diode pair across the inputs ([Figure 54](#)).

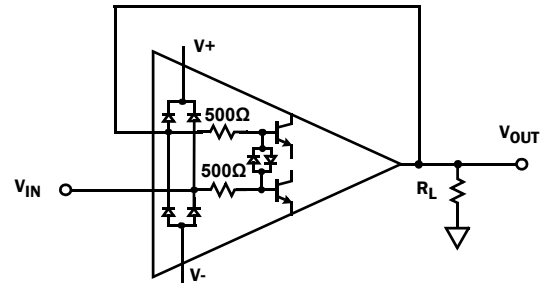

FIGURE 54. INPUT ESD DIODE CURRENT LIMITING- UNITY GAIN

The series resistors limit the high feed-through currents that can occur in pulse applications when the input  $dv/dt$  exceeds the 0.5V/ $\mu$ s slew rate of the amplifier. Without the series resistors, the input can forward-bias the anti-parallel diodes causing current to flow to the output resulting in severe distortion and possible diode failure. [Figure 48](#) provides an example of distortion free large signal response using a 4V<sub>p,p</sub> input pulse with an input rise time of <1ns. The series resistors enable the input differential voltage to be equal to the maximum power supply voltage (40V) without damage.

In applications where one or both amplifier input terminals are at risk of exposure to high voltages beyond the power supply rails, current limiting resistors may be needed at the input terminal to limit the current through the power supply ESD diodes to 20mA maximum.

### Output Current Limiting

The output current is internally limited to approximately  $\pm 45$ mA at +25 $^{\circ}$ C and can withstand a short-circuit to either rail as long as the power dissipation limits are not exceeded. This applies to only 1 amplifier at a time for the dual op amp. Continuous operation under these conditions may degrade long term reliability. [Figures 27](#) and [28](#) show the current limit variation with temperature.

### Output Phase Reversal

Output phase reversal is a change of polarity in the amplifier transfer function when the input voltage exceeds the supply voltage. The ISL28117, ISL28217, ISL28417 and ISL28417SEH are immune to output phase reversal, even when the input voltage is 1V beyond the supplies.

### Unused Channels

You must configure unused channel(s) to prevent them from oscillating. The unused channel(s) oscillates if the input and output pins are floating. This results in higher than expected supply currents and possible noise injection into the other channel(s) being used. The proper way to prevent this oscillation is to short the output to the inverting input and ground the positive input, as shown in [Figure 55](#).

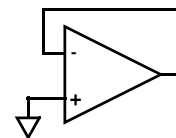

FIGURE 55. PREVENTING OSCILLATIONS IN UNUSED CHANNELS

## Power Dissipation

It is possible to exceed the +150°C maximum junction temperatures under certain load and power supply conditions. It is therefore important to calculate the maximum junction temperature ( $T_{JMAX}$ ) for all applications to determine if power supply voltages, load conditions, or package type need to be modified to remain in the safe operating area. These parameters are related using [Equation 1](#):

$$T_{JMAX} = T_{MAX} + \theta_{JA} \times PD_{MAXTOTAL} \quad (EQ. 1)$$

where:

- $PD_{MAXTOTAL}$  is the sum of the maximum power dissipation of each amplifier in the package ( $PD_{MAX}$ )
- $PD_{MAX}$  for each amplifier can be calculated using [Equation 2](#):

$$PD_{MAX} = V_S \times I_{qMAX} + (V_S - V_{OUTMAX}) \times \frac{V_{OUTMAX}}{R_L} \quad (EQ. 2)$$

where:

- $T_{MAX}$  = Maximum ambient temperature
- $\theta_{JA}$  = Thermal resistance of the package
- $PD_{MAX}$  = Maximum power dissipation of 1 amplifier
- $V_S$  = Total supply voltage
- $I_{qMAX}$  = Maximum quiescent supply current of 1 amplifier
- $V_{OUTMAX}$  = Maximum output voltage swing of the application

## ISL28117, ISL28217, ISL28417, ISL28417SEH SPICE Model

[Figure 56](#) shows the SPICE model schematic and [Figure 57](#) shows the net list for the ISL28117, ISL28217, ISL28417 and ISL28417SEH SPICE model for a Grade “B” part. The model is a simplified version of the actual device and simulates important AC and DC parameters. AC parameters incorporated into the model are: 1/f and flatband noise, Slew Rate, CMRR, Gain and Phase. The DC parameters are VOS, IOS, total supply current and output voltage swing. The model uses typical parameters given in the “Electrical Specifications” table beginning on [page 8](#). The AVOL is adjusted for 155dB with the dominant pole at 0.02Hz. The CMRR is set (210dB,  $f_{cm} = 10\text{Hz}$ ). The input stage models the actual device to present an accurate AC representation. The model is configured for ambient temperature of +25°C.

[Figures 58](#) through [68](#) show the characterization vs simulation results for the Noise Voltage, Closed Loop Gain vs Frequency, Closed Loop Gain vs  $R_L$ , Large Signal Step Response, Open Loop Gain Phase and Simulated CMRR vs Frequency.

## License Statement

The information in this SPICE model is protected under the United States copyright laws. Renesas Electronics Corporation hereby grants users of this macro-model hereto referred to as “Licensee”, a nonexclusive, nontransferable license to use this model as long as the Licensee abides by the terms of this agreement. Before using this macro-model, the Licensee should read this license. If the Licensee does not accept these terms, permission to use the model is not granted.

The Licensee may not sell, loan, rent, or license the macro-model, in whole, in part, or in modified form, to anyone outside the Licensee’s company. The Licensee may modify the macro-model to suit his/her specific applications and the Licensee may make copies of this macro-model for use within their company only.

This macro-model is provided “AS IS, WHERE IS AND WITH NO WARRANTY OF ANY KIND EITHER EXPRESSED OR IMPLIED, INCLUDING, BUT NOT LIMITED TO, ANY IMPLIED WARRANTIES OF MERCHANTABILITY AND FITNESS FOR A PARTICULAR PURPOSE.”

Renesas is not liable for special, collateral, incidental, or consequential damages in connection with or arising out of the use of this macro-model. Renesas reserves the right to make changes to the product and the macro-model without prior notice.

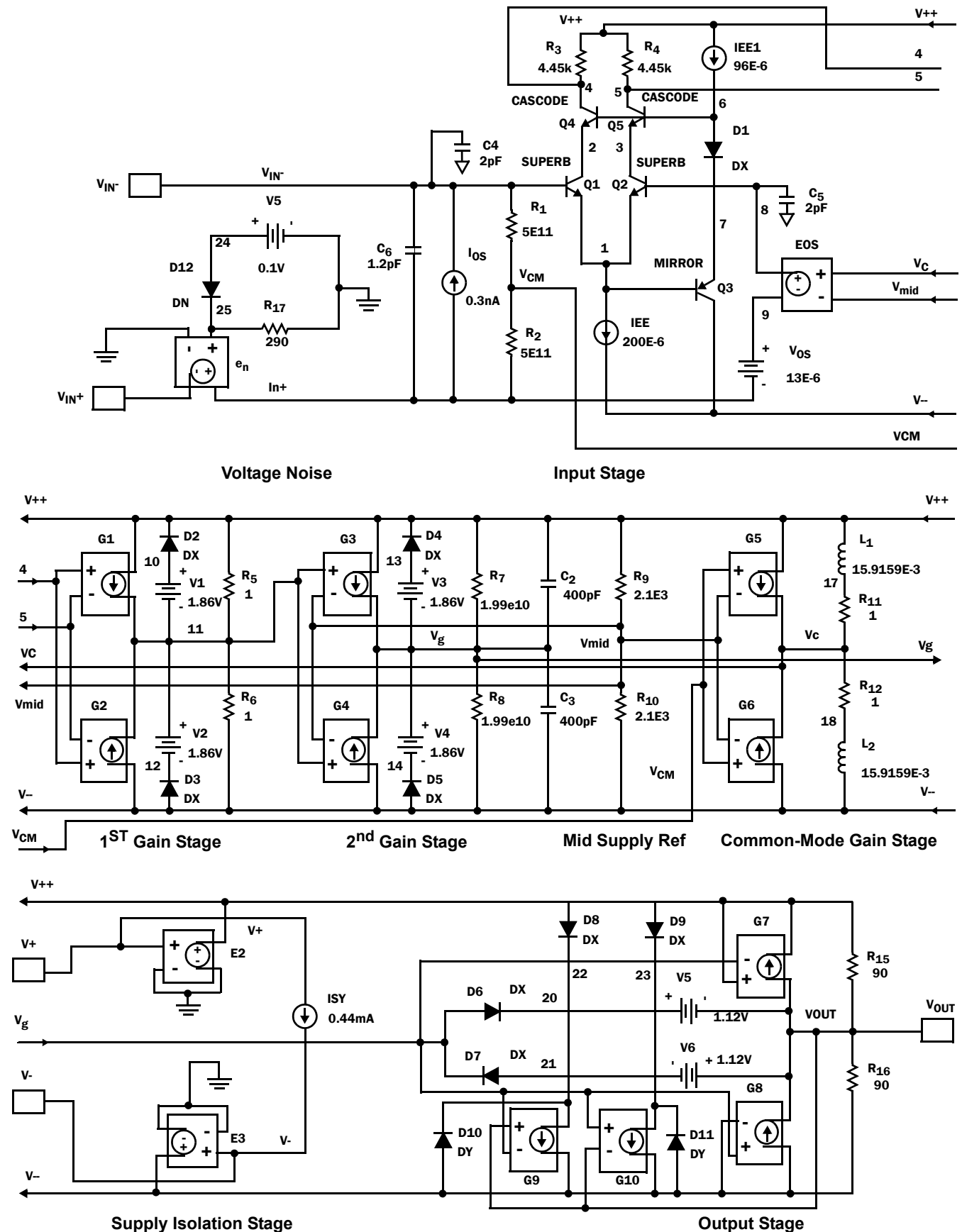

FIGURE 56. SPICE SCHEMATIC

```

*ISL28117 Macromodel - covers following
*products
*ISL28117
*ISL28217
*ISL28417 and ISL28417SEH
**Revision History:
*Revision C, LaFontaine January 31, 2012
*Model for Noise, quiescent supply currents,
*CMRR 210dB, fcm=10Hz, AVOL 155dB
*f=0.02Hz, SR = 0.5V/us, output voltage
*clamp and short ckt current limit.
*
*Copyright 2012 by Intersil Corporation
Refer *to data sheet "LICENSE STATE-
MENT", Use *of this model indicates your
acceptance with *the terms and provisions
in the License *Statement.
*Intended use:
*This Pspice Macromodel is intended to
give
*typical DC and AC performance
*characteristics under a wide range of
*external circuit configurations using
*compatible simulation platforms - such as
*iSim PE.
**
*Device performance features supported by
*this model
*Typical, room temp., nominal power supply
*voltages used to produce the following
*characteristics:
*Open and closed loop I/O impedances
*Open loop gain and phase
*Closed loop bandwidth and frequency
*response
*Loading effects on closed loop frequency
*response
*Input noise terms including 1/f effects
*Slew rate
*Input and Output Headroom limits to I/O
*voltage swing
*Supply current at nominal specified supply
*voltages
**
*Device performance features NOT
*supported by this model:
*Harmonic distortion effects
*Post Radiation effects
*Disable operation (if any)
*Thermal effects and/or over temperature
*parameter variation
*Limited performance variation vs. supply
*voltage is modeled
*Part to part performance variation due to
*normal process parameter spread
*Any performance difference arising from
*different packaging
* source
:
*+input
*|-input
*| | +Vsupply
*| | |-Vsupply
*| | |output

*| | | |
.subckt ISL28117 Vin+ Vin- V+ V- VOUT
* source ISL28107subckt
*
*Voltage Noise
E_En IN+ VIN+ 25 0 1
R_R17 25 0 290
D_D12 24 25 DN
V_V7 24 0 0.1
*
*Input Stage
I_IOS IN+ VIN- DC 0.08E-9
C_C6 IN+ VIN- 1.2E-12
R_R1 VCM VIN- 5e11
R_R2 IN+ VCM 5e11
Q_Q1 2 VIN- 1 SuperB
Q_Q2 3 8 1 SuperB
Q_Q3 V-- 1 7 Mirror
Q_Q4 4 6 2 Cascode
Q_Q5 5 6 3 Cascode
R_R3 4 V++ 4.45e3
R_R4 5 V++ 4.45e3
C_C4 VIN- 0 2e-12
C_C5 8 0 2e-12
D_D1 6 7 DX
I_IEE 1 V-- DC 200e-6
I_IEE1 V++ 6 DC 96e-6
V_VOS 9 IN+ 8e-6
E_EOS 8 9 VC VMID 1
*
*1st Gain Stage
G_G1 V++ 11 4 5 8.129384e-2
G_G2 V-- 11 4 5 8.129384e-2
R_R5 11 V++ 1
R_R6 V-- 11 1
D_D2 10 V++ DX
D_D3 V-- 12 DX
V_V1 10 11 1.86
V_V2 11 12 1.86
*
*2nd Gain Stage
G_G3 V++ VG 11 VMID 2.83e-3
G_G4 V-- VG 11 VMID 2.83e-3
R_R7 VG V++ 1.99e10
R_R8 V-- VG 1.99e10
C_C2 VG V++ 4e-10
C_C3 V-- VG 4e-10
D_D4 13 V++ DX
D_D5 V-- 14 DX
V_V3 13 VG 1.86
V_V4 VG 14 1.86
*
*Mid supply Ref
R_R9 VMID V++ 2.1E3
R_R10 V-- VMID 2.1E3
I_ISY V+ V- DC 0.44E-3
E_E2 V++ 0 V+ 0 1
E_E3 V-- 0 V- 0 1
*
*Common Mode Gain Stage with Zero
G_G5 V++ VC VCM VMID 3.162277
G_G6 V-- VC VCM VMID 3.162277
R_R11 VC 17 1
R_R12 18 VC 1

L_L1 17 V++ 15.9159E-3
L_L2 18 V-- 15.9159E-3
*
*Output Stage with Correction Current
Sources
G_G7 VOUT V++ V++ VG 1.11e-2
G_G8 V-- VOUT VG V-- 1.11e-2
G_G9 22 V-- VOUT VG 1.11e-2
G_G10 23 V-- VG VOUT 1.11e-2
D_D6 VG 20 DX
D_D7 21 VG DX
D_D8 V++ 22 DX
D_D9 V++ 23 DX
D_D10 V-- 22 DY
D_D11 V-- 23 DY
V_V5 20 VOUT 1.12
V_V6 VOUT 21 1.12
R_R15 VOUT V++ 9E1
R_R16 V-- VOUT 9E1
*
.model SuperB npn
+ is=184E-15 bf=30e3 va=15 ik=70E-3
rb=50
+ re=0.065 rc=35 cje=1.5E-12 cjc=2E-12
+ kf=0 af=0
.model Cascode npn
+ is=502E-18 bf=150 va=300 ik=17E-3
+rb=140 re=0.011 rc=900 cje=0.2E-12
+cjc=0.16E-12f kf=0 af=0
.model Mirror pnp
+ is=4E-15 bf=150 va=50 ik=138E-3 rb=185
+ re=0.101 rc=180 cje=1.34E-12
+cjc=0.44E-12 kf=0 af=0
.model DN D(KF=6.69e-9 AF=1)
.MODEL DX D(IS=1E-12 Rs=0.1)
.MODEL DY D(IS=1E-15 BV=50 Rs=1)
.ends ISL28117

```

FIGURE 57. SPICE NET LIST

## Characterization vs Simulation Results

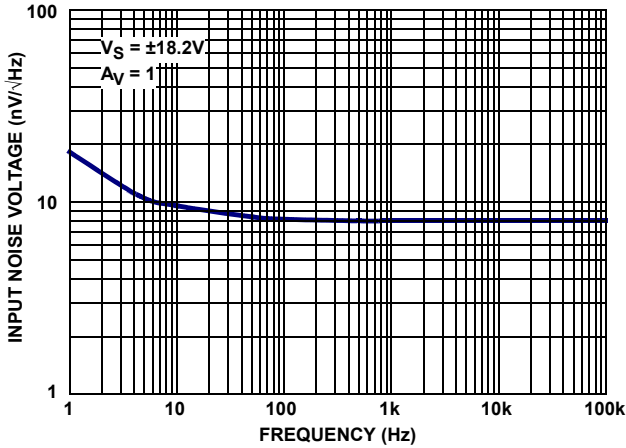

FIGURE 58. CHARACTERIZED INPUT NOISE VOLTAGE

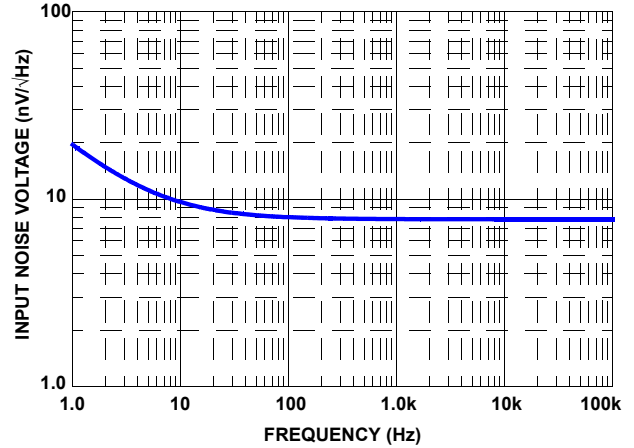

FIGURE 59. SIMULATED INPUT NOISE VOLTAGE

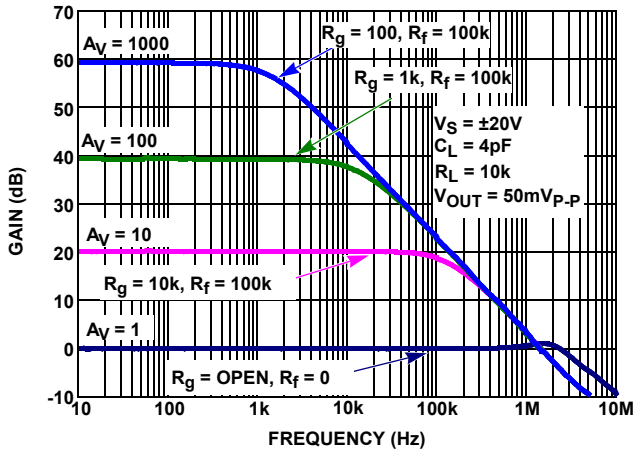

FIGURE 60. CHARACTERIZED CLOSED LOOP GAIN vs FREQUENCY

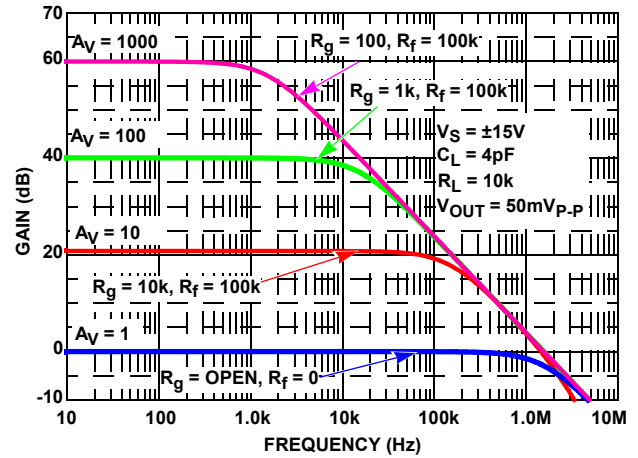

FIGURE 61. SIMULATED CLOSED LOOP GAIN vs FREQUENCY

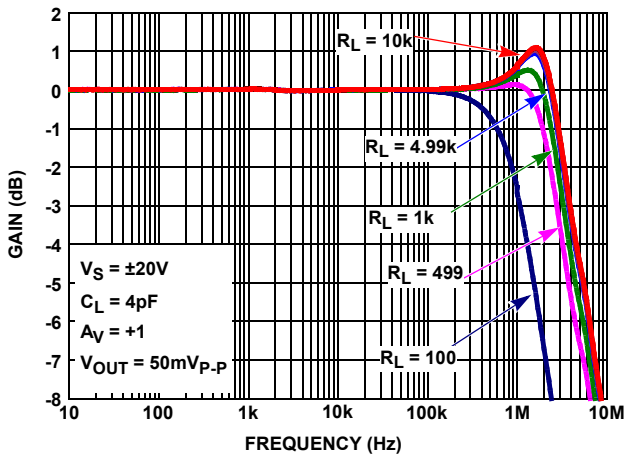

FIGURE 62. CHARACTERIZED CLOSED LOOP GAIN vs  $R_L$

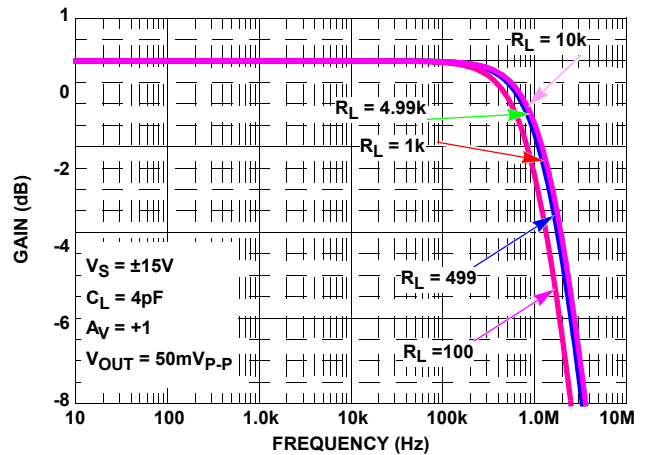

FIGURE 63. SIMULATED CLOSED LOOP GAIN vs  $R_L$

## Characterization vs Simulation Results (Continued)

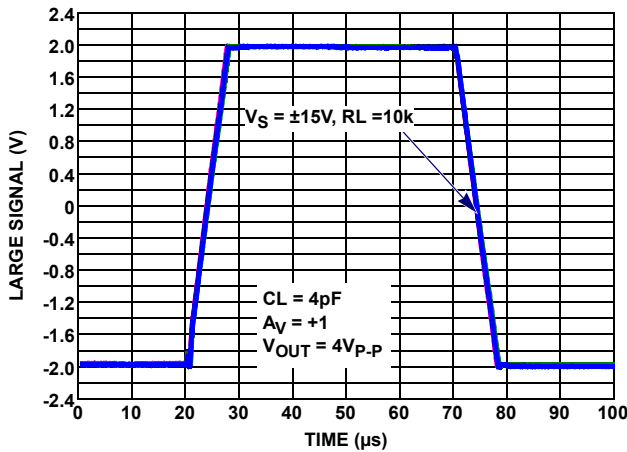

FIGURE 64. CHARACTERIZED LARGE SIGNAL TRANSIENT RESPONSE vs  $R_L$   $V_S = \pm 15V$

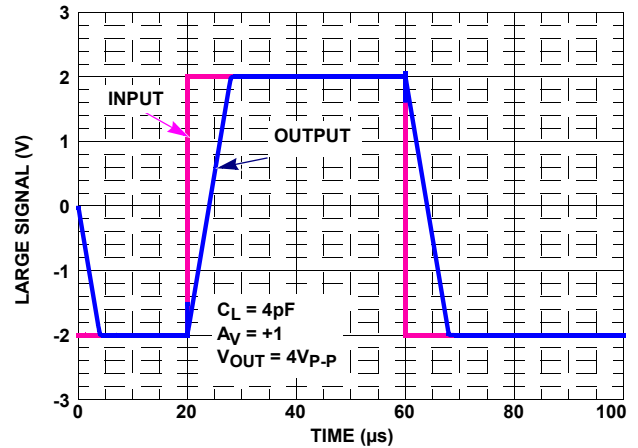

FIGURE 65. SIMULATED LARGE SIGNAL 10V STEP RESPONSE

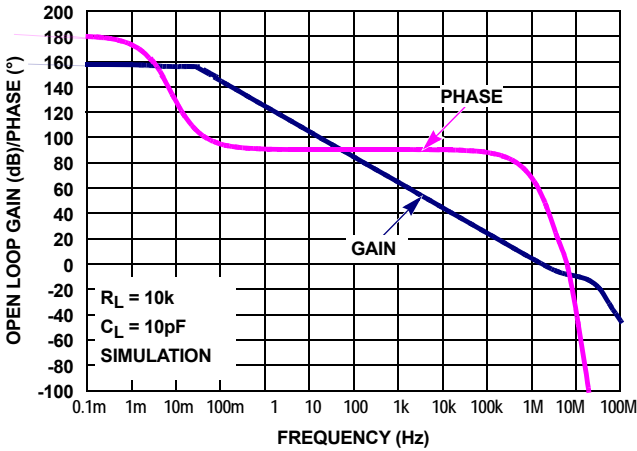

FIGURE 66. SIMULATED OPEN-LOOP GAIN, PHASE vs FREQUENCY

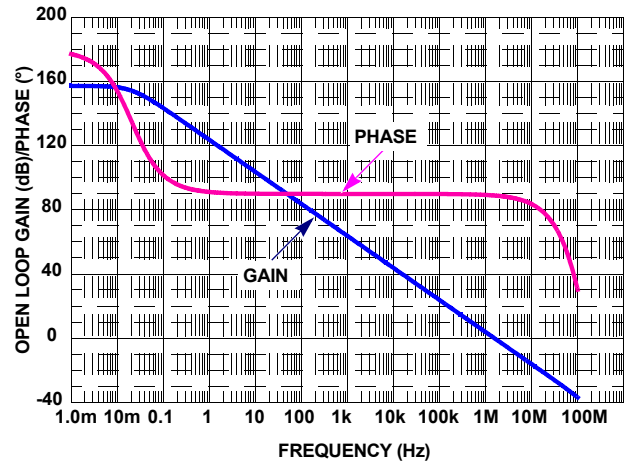

FIGURE 67. SIMULATED OPEN-LOOP GAIN, PHASE vs FREQUENCY

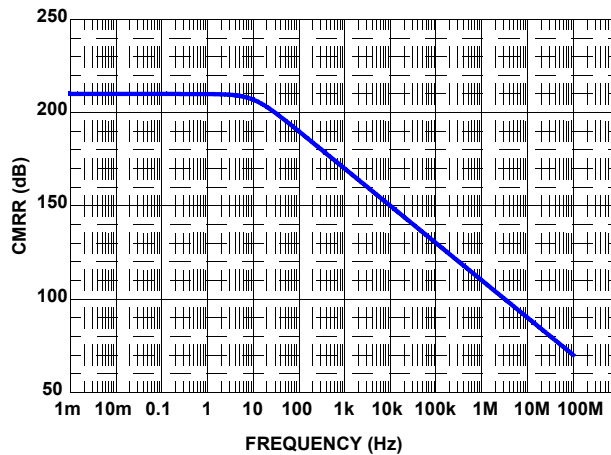

FIGURE 68. SIMULATED CMRR vs FREQUENCY

## Metallization Mask Layout

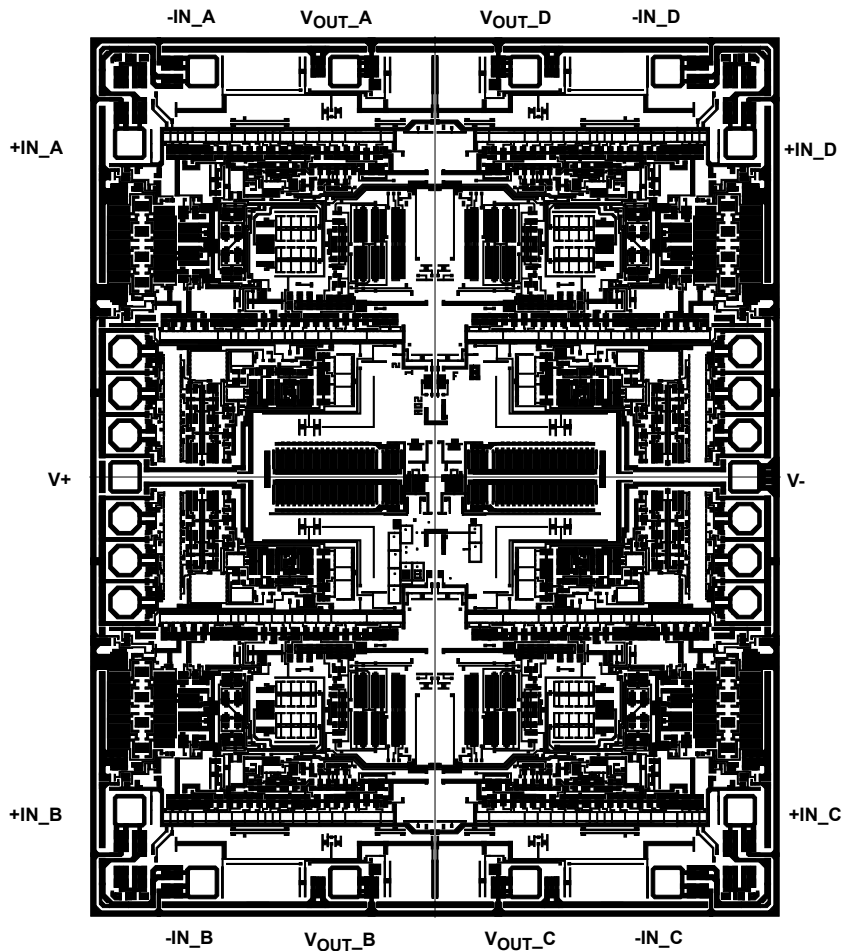

TABLE 2. DIE LAYOUT X-Y COORDINATES

| PAD NAME | PAD NUMBER | X (μm) | Y (μm) | dX (μm) | dY (μm) | BOND WIRES PER PAD |
|----------|------------|--------|--------|---------|---------|--------------------|
| VOUT_A   | 3          | -256   | 1152   | 70      | 70      | 1                  |
| -IN_A    | 4          | -661   | 1152   | 70      | 70      | 1                  |
| +IN_A    | 5          | -867.5 | 948.5  | 70      | 70      | 1                  |
| V+       | 9          | -880.5 | 0      | 70      | 70      | 1                  |
| +IN_B    | 13         | -867.5 | -948.5 | 70      | 70      | 1                  |
| -IN_B    | 14         | -661   | -1152  | 70      | 70      | 1                  |
| VOUT_B   | 15         | -256   | -1152  | 70      | 70      | 1                  |
| VOUT_C   | 16         | 256    | -1152  | 70      | 70      | 1                  |
| -IN_C    | 17         | 661    | -1152  | 70      | 70      | 1                  |
| +IN_C    | 18         | 867.5  | -948.5 | 70      | 70      | 1                  |
| V-       | 22         | 880.5  | 0      | 70      | 70      | 1                  |
| +IN_D    | 26         | 867.5  | 948.5  | 70      | 70      | 1                  |
| -IN_D    | 1          | 661    | 1152   | 70      | 70      | 1                  |
| VOUT_D   | 2          | 256    | 1152   | 70      | 70      | 1                  |

NOTE: Origin of coordinates is the center of die.

## Revision History

The revision history provided is for informational purposes only and is believed to be accurate, but not warranted. Please go to web to make sure you have the latest Rev.

| DATE         | REVISION  | CHANGE   |
|--------------|-----------|--|
| Sep 13, 2019 | FN6632.13 | Updated Related Literature.<br>Updated links throughout document.<br>Updated ordering information table adding tape and reel information to table and updating notes.<br>Added Note 4.<br>Updated Figures 50 and 51.<br>Removed About Intersil<br>Updated Disclaimer.  |
| Mar 30, 2016 | FN6632.12 | Removed Note that references SMD for the ISL28417SEH from ordering information table on page 3 and removed ISL28417SEH from MSL note due to not applicable.  |
| Mar 16, 2016 | FN6632.11 | -Added the ISL28417SEH throughout the datasheet.<br>-Updated POD L8.3x3k to most recent revision with change as follows:<br>Tiebar Note 5 updated<br>From: Tiebar shown (if present) is a non-functional feature.<br>To: Tiebar shown (if present) is a non-functional feature and may be located on any of the 4 sides (or ends).<br>-Added about Intersil verbiage<br>-Electrical Specifications Table Title on page 8: Added ISL28117, ISL28217, ISL28417 (VS ± 15V).<br>-Electrical Specifications Table Title on page 10: Added ISL28117, ISL28217, ISL28417 (VS ± 5V). |
| Sep 11, 2012 | FN6632.10 | Feature on page 1: Added No phase reversal.<br>Removed from ordering information QFN parts ISL28417FRZ (not release part) on Page 3.<br>Removed all instances of QFN through document (front page, table of contents, thermal information, pin description and POD).<br>Added to the typical performance curves table figure 53 on page 23: <b>Common-mode input impedance.</b>  |

The revision history provided is for informational purposes only and is believed to be accurate, but not warranted. Please go to web to make sure you have the latest Rev. **(Continued)**

| DATE         | REVISION | CHANGE   |
|--------------|----------|--|
| Feb 23, 2012 | FN6632.9 | <p>“Ordering Information” on page 2:<br/>                     Removed “Coming soon” from ISL28417FVZ and changed Part Marking column from “28417 FVZ” to 28417 FVZ-C”. Changed “-40 to +125” to “200 C-grade”<br/>                     Added new Part Number ISL28417 FVBZ<br/>                     Electrical Spec changes:<br/>                     VOS Description Section: page 8 &amp; page 10: Changed “Input Offset Voltage; SOIC Package” to Input Offset Voltage; SOIC, TSSOP Package”<br/>                     TCVOS Description section: page 8 &amp; page 10: Changed;Input Offset Voltage Temperature Coefficient; SOIC Package to Input Offset Voltage Temperature Coefficient; SOIC, TSSOP Package<br/>                     TCIOS Conditions section: page 8 &amp; page 10: Changed “ISL28417 SOIC B and C Grade” to “ISL28417 SOIC, TSSOP B and C Grade”.</p> <hr/> <p>“Ordering Information” on page 3:<br/>                     Updated Pkg. Dwg. # for ISL28117FUBZ, ISL28117FUZ, ISL28217FUBZ &amp; ISL28217FUZ from M8.118 to M8.118B<br/>                     Updated Pkg. Dwg. # for ISL28117FRTBZ, ISL28117FRTZ, ISL28217FRTBZ &amp; ISL28217FRTZ from L8.3x3A to L8.3x3K<br/>                     Updated Pkg. Dwg. # for ISL28417FRZ from L16.4x4 to L16.4x4E<br/>                     “Thermal Information” on page 7:<br/>                     Added <math>\Theta_{JA}</math> and <math>\Theta_{JC}</math> for 16 Ld QFN and 14 Ld TSSOP<br/>                     Figure 52, “% OVERSHOOT vs LOAD CAPACITANCE, <math>V_S = \pm 15V</math>” on page 23:<br/>                     X-Axis (Capacitance pF) values 1k and 10k were shifted 1 decade to the right. Shifted 1 decade to the left and added new label “100k” at the extreme right (where the “10k” value was located).<br/>                     Added dual and quad to the “SPICE NET LIST” on page 27.<br/>                     “Package Outline Drawing” on page 35:<br/>                     Changed from M8.118 to M8.118B<br/>                     Top View:<br/>                     Package width &amp; height changed from 3.0±0.05 to 3.0±0.1<br/>                     Package height from lead to lead changed from 4.9±0.15 to 4.9±0.2<br/>                     Side View 2:<br/>                     Lead thickness changed from 0.09-0.20 to 0.15±0.05mm<br/>                     Side View 1:<br/>                     Package height changed from 0.85±0.10 to 0.86±0.05<br/>                     Changed lead width from 0.25-0.036 to 0.23-0.36<br/>                     Detail X:<br/>                     Foot of lead length changed from 0.55±0.15 to 0.53±0.10<br/>                     “Package Outline Drawing” on page 36:<br/>                     Changed from L8.3x3A to L8.3x3K<br/>                     Bottom View:<br/>                     Changed lead height from 0.3±0.1 to 0.4±0.05<br/>                     Changed lead width from 0.30±0.05 to 0.25±0.05<br/>                     Land Pattern:<br/>                     Changed lead width from 0.30 to 0.25</p> |

The revision history provided is for informational purposes only and is believed to be accurate, but not warranted. Please go to web to make sure you have the latest Rev. (Continued)

| DATE         | REVISION | CHANGE   |
|--------------|----------|--|
| Oct 11, 2011 | FN6632.8 | <p>Figure 27 added "Positive" to Short-Circuit Current title<br/>                     Figure 28 added "Negative" to Short-Circuit Current title<br/>                     Figure 36 y axis label units changed from (nV/<math>\sqrt{\text{Hz}}</math>) to (nV/<math>\sqrt{\text{Hz}}</math>)<br/>                     Figure 37 y axis label units changed from pA/<math>\sqrt{\text{Hz}}</math> to pA/<math>\sqrt{\text{Hz}}</math><br/>                     Figure 31, 33 changed from VOUT vs Temperature to VOH vs Temperature<br/>                     Figure 32, 34 changed from VOUT vs Temperature to VOL vs Temperature<br/>                     Table of Contents on page 5 updated to list all package outline drawings<br/>                     Changed POD M14.15 to MDP0027<br/>                     Changed TClos for ISL28417 SOIC grade B and C on pages 7 and 9 from <math>\pm 3.5\text{pA/C}</math> to <math>\pm 4.0\text{pA/C}</math></p> <ol style="list-style-type: none"> <li>1. Pg 2 Ordering Information:                             <ol style="list-style-type: none"> <li>a. Added ordering information rows for ISL28417FBBZ (B grade) and ISL28417FBZ (C grade).</li> <li>b. Add Table of Contents</li> </ol> </li> <li>2. Pg 5 Abs Max and Thermal Information Tables:                             <ol style="list-style-type: none"> <li>a. Added HBM, MM and CDM ESD levels for the '417</li> <li>b. Added <math>\theta_{JA}</math> and <math>\theta_{JC}</math> values for the 14 Ld SOIC</li> </ol> </li> <li>3. Pg 6 <math>\pm 15\text{V}</math> electrical Specs                             <ol style="list-style-type: none"> <li>a. Added ISL28417 B &amp; C grade VOS and limits</li> <li>b. Added ISL28417 B &amp; C grade TCvos and limits</li> <li>c. Added ISL28417 B &amp; C grade TCios and limits</li> </ol> </li> <li>4. Pg 7                             <ol style="list-style-type: none"> <li>a. Converted AVOL limits and units from 3kV/mV Min and 14kV/mV typ to 130dB and 143dB respectively</li> </ol> </li> <li>5. Pg 8 <math>\pm 5\text{V}</math> electrical Specs                             <ol style="list-style-type: none"> <li>a. Added ISL28417 B &amp; C grade VOS and limits</li> </ol> </li> <li>6. Pg 9                             <ol style="list-style-type: none"> <li>a. Added ISL28417 B &amp; C grade TCvos and limits</li> <li>b. Added ISL28417 B &amp; C grade TCios and limits</li> <li>c. Converted AVOL limits and units from 3kV/mV Min and 14kV/mV Typ to 130dB and 143dB respectively</li> </ol> </li> <li>7. Pg 17 Applications Information                             <ol style="list-style-type: none"> <li>a. Added Unused Channels paragraph and Figure 54.</li> </ol> </li> </ol> |
| Jul 12, 2011 | FN6632.7 | <ol style="list-style-type: none"> <li>1. Releasing ISL28217FUZ MSOP Grade C package. Remove 'Coming Soon' from Order Information Table</li> <li>2. Page 5, added: Machine Model (ISL28217 MSOP only). . . . 300V</li> <li>3. Under Electrical Spec <math>\pm 15\text{V}</math> and <math>\pm 5\text{V}</math> tables, changed Typical Rise Time and Fall Time from: Rise Time 100ns, Fall Time 120ns, to: Rise Time 130ns, Fall Time 130ns.</li> <li>4. Under Electrical Spec <math>\pm 15\text{V}</math> and <math>\pm 5\text{V}</math> table for Vos and TCvos, added in row for ISL28217 MSOP Grade C package. Added Vos and TCvos limits for 25C and Full Temp.</li> <li>5. For Typical performance curves for Vos Histograms, added note that histogram is based on ISL28217FBBZ for Grade B figures and ISL28217FBZ for Grade C figures. (Figures 3-6, added part number label to graph below Vs)</li> <li>6. Under Electrical Spec <math>\pm 15\text{V}</math> and <math>\pm 5\text{V}</math> tables, changed TYP for Open Loop Gain from 18,000V/mV to 14,000V/mV</li> </ol>  |
| Dec 2, 2010  | FN6632.6 | <ol style="list-style-type: none"> <li>1. Updated "Ordering Information" table on page 3. Removed Coming Soon for ISL28117FRTBZ and ISL28117FUBZ parts. Added in the Vos (MAX) numbers in those rows (75 and 70 respectively).</li> <li>2. Corrected part marking in "Ordering Information" table on page 3 for ISL28117FRITZ from 8117 -C to -C 8117</li> <li>3. Corrected part marking in "Ordering Information" table on page 3 for ISL28217FRITZ from 8217 -C to -C 8217</li> <li>4. Updated Tape &amp; Reel note in "Ordering Information" table on page 3 from "Add "-T7", "-T7A" or "-T13" suffix for tape and reel." to new standard "Add "-T*" suffix for tape and reel." The "*" covers all possible tape and reel options</li> <li>5. Updated "Electrical Specifications" Table for "V<sub>OS</sub>" on page 8 and "TCV<sub>OS</sub>" on page 8                             <ol style="list-style-type: none"> <li>a. Added data row for Offset Voltage; MSOP Grade B Package; ISL28117</li> <li>b. Added data row for Offset Voltage; TDFN Grade B Package; ISL28117</li> <li>c. Added data row for Input Offset Voltage Temperature Coefficient; MSOP Grade B Package; ISL28117</li> <li>d. Added data row for Input Offset Voltage Temperature Coefficient; TDFN Grade B Package; ISL28117</li> </ol> </li> <li>6. Removed "Temperature data established by characterization" from common conditions of spec table. Removed note "Parameters with MIN and/or MAX limits are 100% tested at +25°C, unless otherwise specified. Temperature limits established by characterization and are not production tested." from Min Max columns of spec table. Replaced with new standard note in Min Max columns, "Compliance to datasheet limits is assured by one or more methods: production test, characterization and/or design."</li> </ol>   |

The revision history provided is for informational purposes only and is believed to be accurate, but not warranted. Please go to web to make sure you have the latest Rev. **(Continued)**

| DATE         | REVISION | CHANGE   |
|--------------|----------|--|
| Aug 31, 2010 | FN6632.5 | <p>1. General changes:</p> <ul style="list-style-type: none"> <li>a. Added in Quad devices to the datasheet for SOIC, TSSOP and QFN packages.</li> <li>b. Added in TDFN packages for single and dual devices.</li> <li>c. Added in new VOS and TC沃斯 limits for TDFN packages</li> <li>d. Added Tja and Tjc Notes for TDFN Package which are "direct attach (Tja) " and "bottom (Tjc)"</li> </ul> <p>2. Specific changes:</p> <ul style="list-style-type: none"> <li>a. Added in ISL28417 to title and front page info on page 1</li> <li>b. Added in ISL28117FRTZ, ISL28117FRTBZ, ISL28217FRTZ, ISL28217FRTBZ, ISL28417FBZ, ISL28417FVZ and ISL28417FRZ packages to Ordering information on page 3 and page 3. Added in -T7 and -T7A tape and reel extensions where applicable.</li> <li>c. Added in TDFN, 14 Ld SOIC, 14 Ld TSSOP and 16 Ld QFN to pin configurations on page 5 and page 3.</li> <li>d. Updated Pin Descriptions tables with new added in packages on page 6.</li> <li>e. Abs Max Table added in thermal packaging info for TDFN packages on page 7.</li> <li>f. Electrical Specifications Table - Added two new line items for VOS spec. TDFN package ISL28217 Grade B limits <math>\pm 70\text{uV}</math> 25C and <math>\pm 140\text{uV}</math> full temp. TDFN package ISL28x17 Grade C limits <math>\pm 150\text{uV}</math> 25C and <math>\pm 250\text{uV}</math> full temp on page 8 and page 10.</li> <li>g. Electrical Specifications Table - Added two new line items for TC沃斯 spec. TDFN package ISL28217 Grade B limits <math>\pm 0.7\text{uV/C}</math> full temp. TDFN package ISL28x17 Grade C limits <math>\pm 1\text{uV/C}</math> on page 8 and page 10.</li> <li>h. Added in PODs for L8.3x3A, M14.15, M14.173 and L16.4x4</li> </ul>  |
| Mar 18, 2010 | FN6632.4 | <p>1. Updated "Ordering Information" on page 3 by adding two rows for MSOP packages ISL28117FUBZ and ISL28117FUZ, which are scheduled to release Q2 2010. Added Pinout accordingly.</p> <p>2. Added POD for MSOP M8.118 to the end of datasheet</p> <p>3. In "Ordering Information" on page 3, Separated each part number with it's own specific -T7 and -T13 suffix and removed "Add "-T7" or "-T13" suffix for Tape and Reel." from Note 1.</p> <p>4. Updated <math>\pm 15</math> and <math>\pm 5\text{V}</math> Electrical Specification table with the following edits:</p> <ul style="list-style-type: none"> <li>A) Separated VOS specs for SOIC and MSOP Grade C packages. Added new VOS specs for MSOP Grade C package.</li> <li>B) Separated TC沃斯 specs for SOIC and MSOP Grade C packages. Added new TC沃斯 specs for MSOP Grade C package.</li> </ul> <p>5. Added "Thermal Information" on page 7 for ISL28117 MSOP package.</p> <p>Added page1.</p> <p>Added Evaluation Boards to "Ordering Information" on page 3.</p> <p>Added Theta JC values to "Thermal Information" on page 7. Added applicable Theta JC Note 7.</p> <p>Updated Theta JA for ISL28217 8 Ld SOIC from <math>115^\circ\text{C/W}</math> to <math>105^\circ\text{C/W}</math>.</p> <p>Part marking in "Ordering Information" on page 3 changed as follows:<br/>         ISL28117FBBZ changed from "28117 FBZ -B" to "28117 FBZ"<br/>         ISL28117FBZ changed from "28117 FBZ" to "28117 FBZ -C"<br/>         ISL28217FBBZ changed from "28217 FBZ -B" to "28217 FBZ"<br/>         ISL28217FBZ changed from "28217 FBZ" to "28217 FBZ -C"</p> <p>On page 15: Changed label in Figure 3 from "<math>V_S = +5\text{V}</math>" to "<math>V_S = \pm 5\text{V}</math>"<br/>         On page 15: Changed label in Figure 4 from "<math>V_S = +15\text{V}</math>" to "<math>V_S = \pm 15\text{V}</math>"</p> <p>Changed Typical VOS spec from "13" to "8" (B Grade), "19" to "4" (C Grade), IB from "0.18" to "0.08, IOS from "0.3" to "0.08". Edited Spice Schematic - L1 from "95.4957" to "15.9159E", R1 from "6k" to 1, R9 from "1" to "2.1E3", R10 from "1" to "2.1E3, R12 from "6k" to "1", L2 from "95.4957" to "15.9159E". Edited Spice Net List - Changed Revision from "A" to "B", Date change from "October 29th 2009" to "November 20th 2009", added after AOL "SR = 0.5V/<math>\mu\text{sec}</math>, Input Stage changed in I_IOS from "0.3E-9" to 0.08E-9", V_VOS "13e-6" to "8e-6", Mid supply Ref R_R9 and R_R10 changed "1" to "2.1E3", Common-Mode Gain Stage with Zero change in G_G5 and G_G6 "5.27046e-15" to "3.162277", R_R11 and R_R12 "6.3" to "1", L_L1 and L_L2 "95.4957" to "15.9159E-3"</p> |
| Nov 12, 2009 | FN6632.3 | <p>Updated Typical Performance Curves Figure 5, 7, 9, 11, 13, 15, 17 and 19. Added Spice Model and license statement. Replaced typical application schematic.</p>  |

The revision history provided is for informational purposes only and is believed to be accurate, but not warranted. Please go to web to make sure you have the latest Rev. **(Continued)**

| DATE         | REVISION | CHANGE   |
|--------------|----------|--|
| Oct 16, 2009 | FN6632.2 | <p>On page 3 "Ordering Information", changed the following:</p> <ul style="list-style-type: none"> <li>a) corrected part marking for ISL28117FBBZ from "28117 -B FBZ" to "28117 FBZ -B". Corrected part marking for ISL28217FBBZ from "28217-B FBZ" to "28217 FBZ -B"</li> <li>B) Updated package outline drawing to most recent revision (no changes were made to package dimensions; land pattern was added and dimensions were moved from table onto drawing)</li> <li>c) Added "Add "-T7" or "-T13" suffix for tape and reel." to the tape and reel Note 1.</li> <li>d) added Note 3 callout to all parts (Note 3 reads: "For Moisture Sensitivity Level (MSL), please see device information page for ISL28117, ISL28217. For more information on MSL please see techbrief TB363.")</li> <li>e) removed "Coming Soon" from ISL28117FBBZ, ISL28117FBZ &amp; ISL28217FBBZ devices</li> </ul>  |
| Oct 8, 2009  | FN6632.1 | <ol style="list-style-type: none"> <li>1. Removed "very" from "...low noise.." 1st sentence, page 1.</li> <li>2. Removed "Low" from 6th bullet under features, page 1.</li> <li>3. Modified typical characteristics curves to show conservative performance. Specific channel designations removed. On temperature curves, changed formatting to indicate range from typical value. Changes include:             <ul style="list-style-type: none"> <li>a. Removed former Figures 1, 3, 5, 7, 9, 10, 13, 14, 17, 18, 21, 22, 25, 26, 29, 30, 33, 34, 37 &amp; 38 (all Channel A curves)</li> <li>b. Replaced former Figures 19, 20, 23, 24, 27, 28, 31, 32, 35, 36, 39 &amp; 40 with new Figures 9 thru 20 (all "conservative channels")</li> <li>c. Added Figures 30, 31, 32</li> </ul> </li> <li>4. Updated TCvos histogram on page 1 to match TCvos histogram Figure 6 on page 7 (same graphic)</li> <li>5. Added temp labels to Figures 28 &amp; 29</li> </ol> |
| Sept 3, 2009 | FN6632.0 | Initial Release  |

# Package Outline Drawings

For the most recent package outline drawing, see [M8.15E](#).

**M8.15E**  
**8 LEAD NARROW BODY SMALL OUTLINE PLASTIC PACKAGE**  
 Rev 0, 08/09

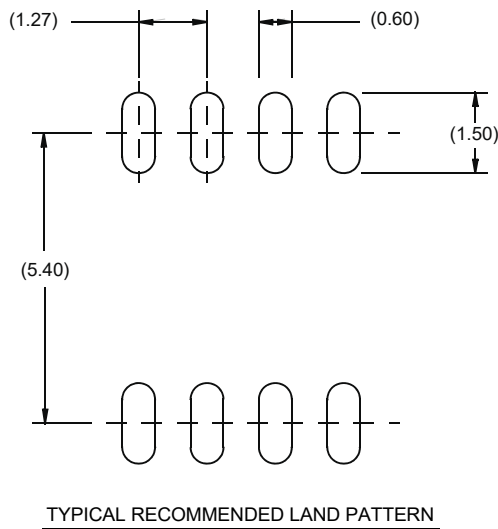
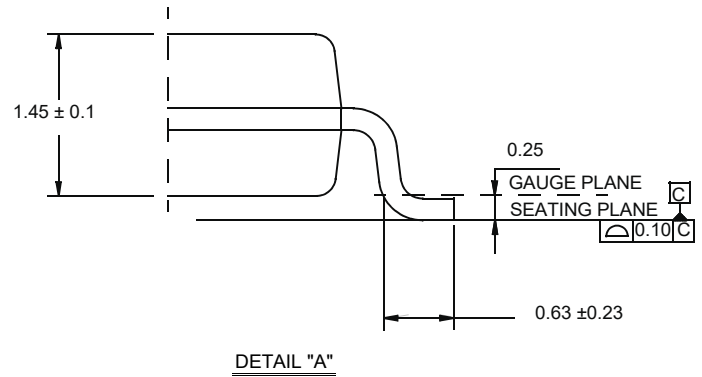
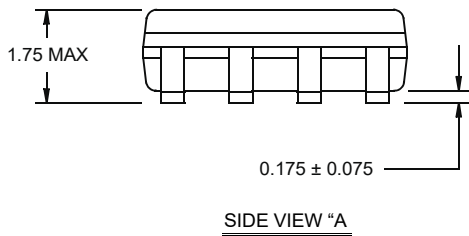
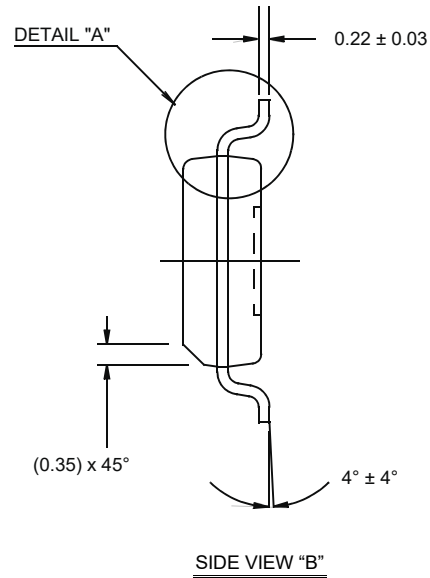
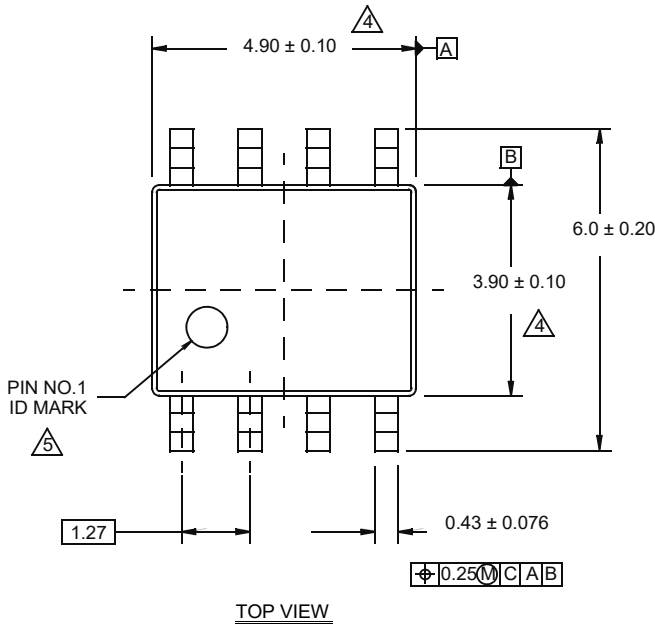

**NOTES:**

1. Dimensions are in millimeters.  
Dimensions in ( ) for Reference Only.
2. Dimensioning and tolerancing conform to AMSE Y14.5m-1994.
3. Unless otherwise specified, tolerance : Decimal ± 0.05
4. Dimension does not include interlead flash or protrusions.  
Interlead flash or protrusions shall not exceed 0.25mm per side.
5. The pin #1 identifier may be either a mold or mark feature.
6. Reference to JEDEC MS-012.

**M8.118B**  
**8 LEAD MINI SMALL OUTLINE PLASTIC PACKAGE**  
 Rev 1, 3/12

For the most recent package outline drawing, see [M8.118B](#).

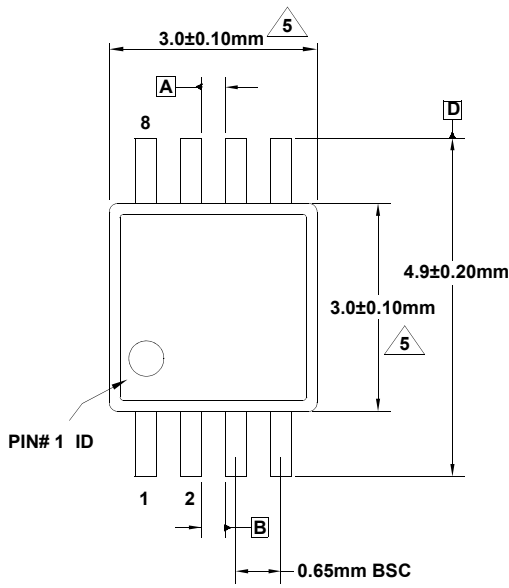

**TOP VIEW**

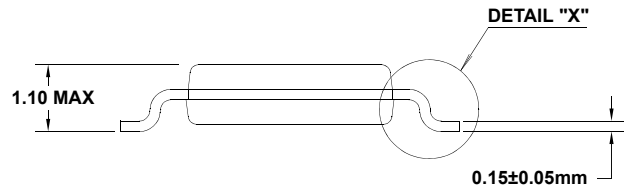

**SIDE VIEW 2**

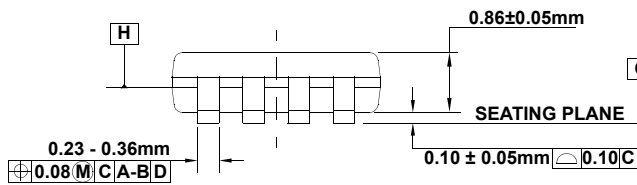

**SIDE VIEW 1**

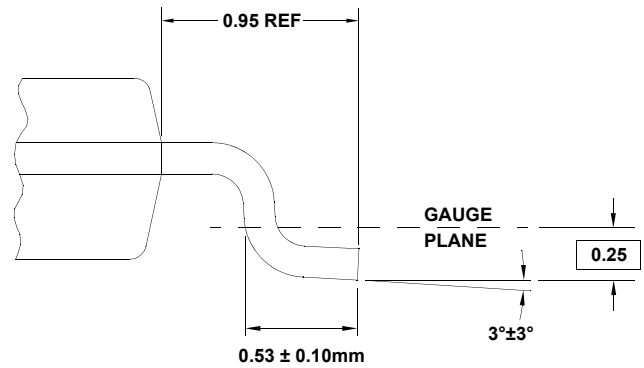

**DETAIL "X"**

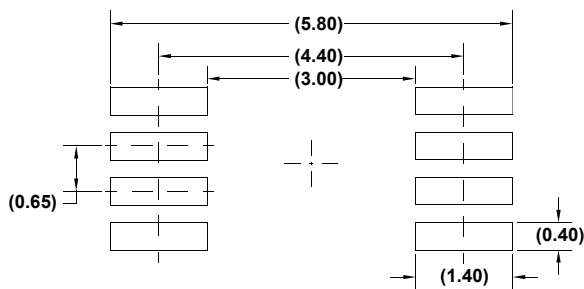

**TYPICAL RECOMMENDED LAND PATTERN**

**NOTES:**

1. Dimensions are in millimeters.
2. Dimensioning and tolerancing conform to JEDEC MO-187-AA and AMSEY14.5m-1994.
3. Plastic or metal protrusions of 0.15mm max per side are not included.
4. Plastic interlead protrusions of 0.15mm max per side are not included.

5. Dimensions are measured at Datum Plane "H".

6. Dimensions in ( ) are for reference only.

L8.3x3K  
 8 LEAD THIN DUAL FLAT NO-LEAD PLASTIC PACKAGE  
 Rev 2, 5/15

For the most recent package outline drawing, see [L8.3x3K](#).

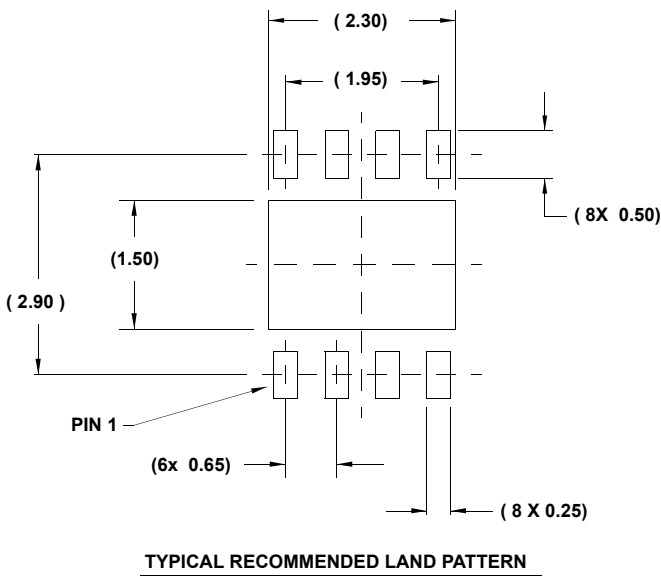
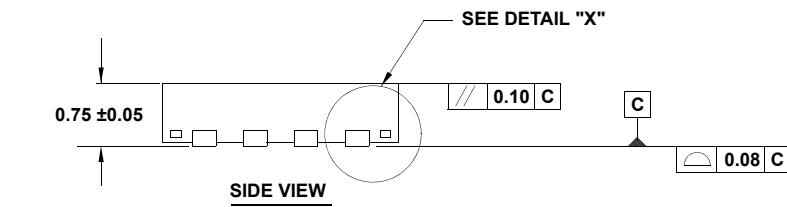
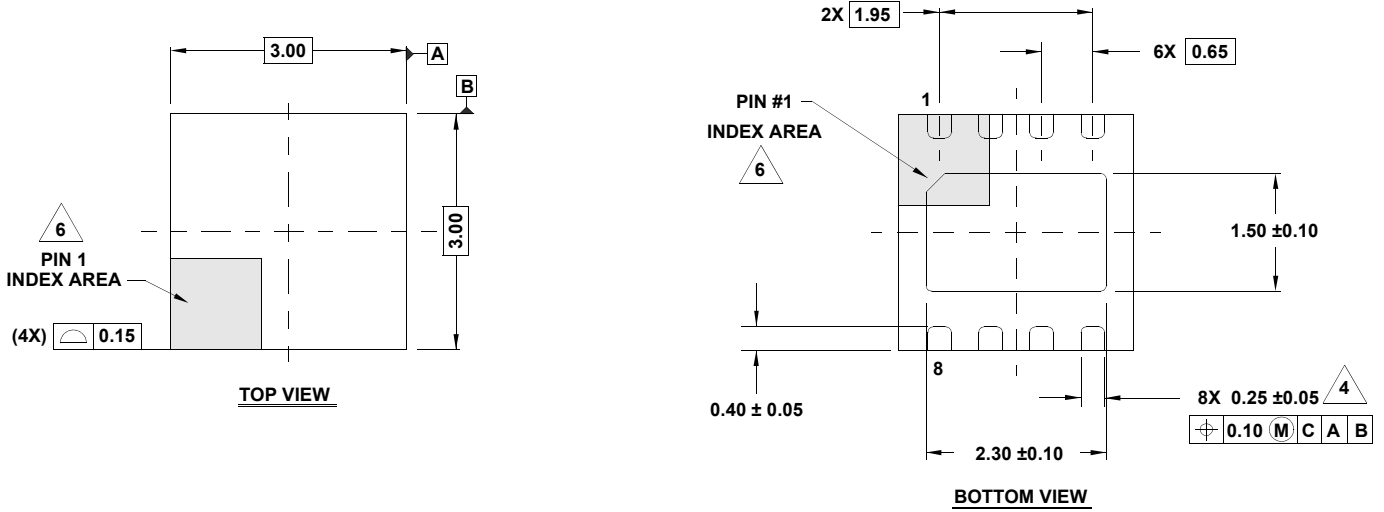

**NOTES:**

1. Dimensions are in millimeters.  
Dimensions in ( ) for Reference Only.
2. Dimensioning and tolerancing conform to ASME Y14.5m-1994.
3. Unless otherwise specified, tolerance : Decimal ± 0.05
4. Dimension applies to the metallized terminal and is measured between 0.15mm and 0.20mm from the terminal tip.
5. Tiebar shown (if present) is a non-functional feature and may be located on any of the 4 sides (or ends).
6. The configuration of the pin #1 identifier is optional, but must be located within the zone indicated. The pin #1 identifier may be either a mold or mark feature.
7. Compliant to JEDEC MO-229 WEEC-2 except for the foot length.

# Small Outline Package Family (SO)

For the most recent package outline drawing, see [MDP0027](#).

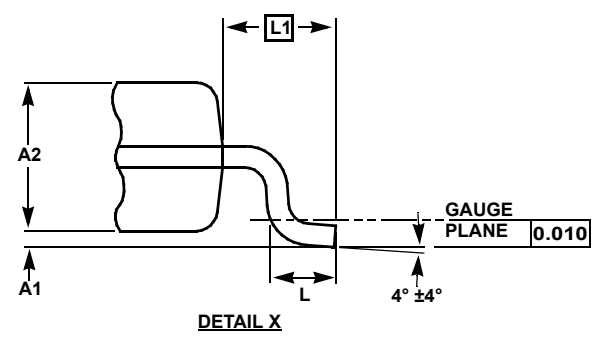
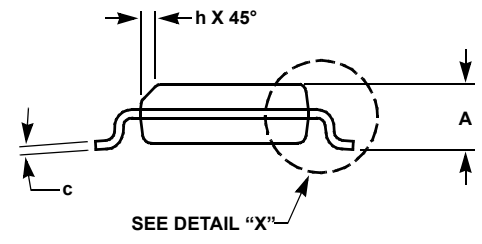
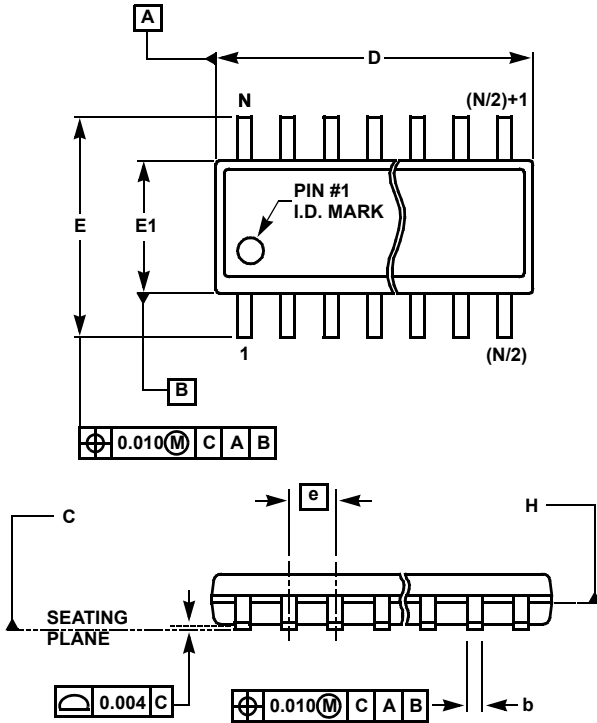

MDP0027  
SMALL OUTLINE PACKAGE FAMILY (SO)

| SYMBOL | INCHES |       |               |                        |               |               |               | TOLERANCE | NOTES |
|--------|--------|-------|---------------|------------------------|---------------|---------------|---------------|-----------|-------|
|        | SO-8   | SO-14 | S016 (0.150") | S016 (0.300") (SOL-16) | S020 (SOL-20) | S024 (SOL-24) | S028 (SOL-28) |           |       |
| A      | 0.068  | 0.068 | 0.068         | 0.104                  | 0.104         | 0.104         | 0.104         | MAX       | -     |
| A1     | 0.006  | 0.006 | 0.006         | 0.007                  | 0.007         | 0.007         | 0.007         | ±0.003    | -     |
| A2     | 0.057  | 0.057 | 0.057         | 0.092                  | 0.092         | 0.092         | 0.092         | ±0.002    | -     |
| b      | 0.017  | 0.017 | 0.017         | 0.017                  | 0.017         | 0.017         | 0.017         | ±0.003    | -     |
| c      | 0.009  | 0.009 | 0.009         | 0.011                  | 0.011         | 0.011         | 0.011         | ±0.001    | -     |
| D      | 0.193  | 0.341 | 0.390         | 0.406                  | 0.504         | 0.606         | 0.704         | ±0.004    | 1, 3  |
| E      | 0.236  | 0.236 | 0.236         | 0.406                  | 0.406         | 0.406         | 0.406         | ±0.008    | -     |
| E1     | 0.154  | 0.154 | 0.154         | 0.295                  | 0.295         | 0.295         | 0.295         | ±0.004    | 2, 3  |
| e      | 0.050  | 0.050 | 0.050         | 0.050                  | 0.050         | 0.050         | 0.050         | Basic     | -     |
| L      | 0.025  | 0.025 | 0.025         | 0.030                  | 0.030         | 0.030         | 0.030         | ±0.009    | -     |
| L1     | 0.041  | 0.041 | 0.041         | 0.056                  | 0.056         | 0.056         | 0.056         | Basic     | -     |
| h      | 0.013  | 0.013 | 0.013         | 0.020                  | 0.020         | 0.020         | 0.020         | Reference | -     |
| N      | 8      | 14    | 16            | 16                     | 20            | 24            | 28            | Reference | -     |

Rev. M 2/07

**NOTES:**

1. Plastic or metal protrusions of 0.006" maximum per side are not included.
2. Plastic interlead protrusions of 0.010" maximum per side are not included.
3. Dimensions "D" and "E1" are measured at Datum Plane "H".
4. Dimensioning and tolerancing per ASME Y14.5M-1994

M14.173  
 14 LEAD THIN SHRINK SMALL OUTLINE PACKAGE (TSSOP)  
 Rev 3, 10/09

For the most recent package outline drawing, see [M14.173](#).

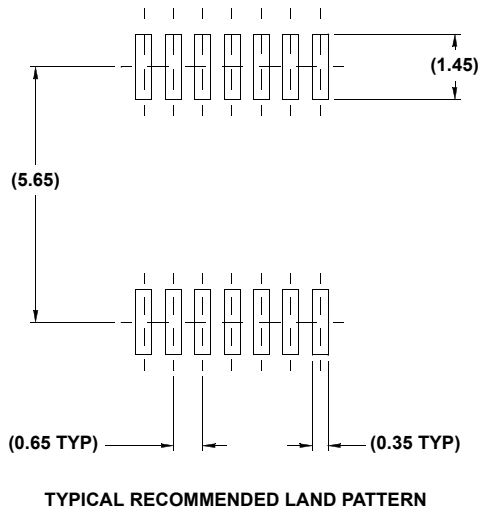
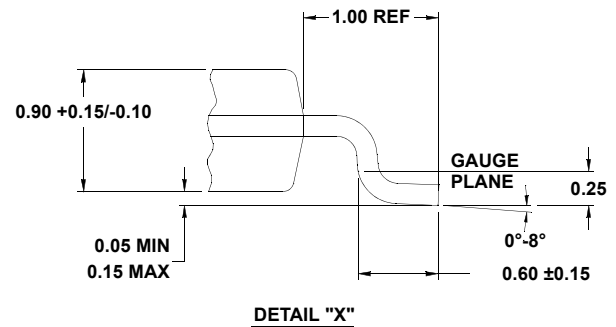
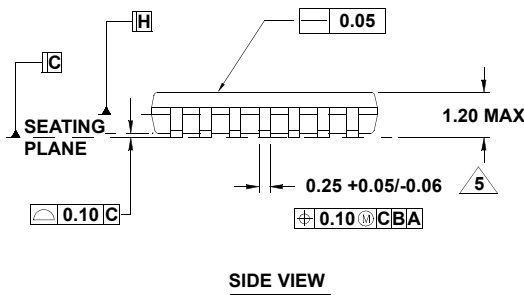
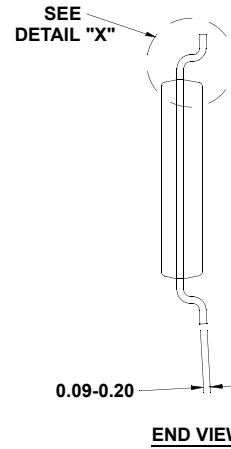
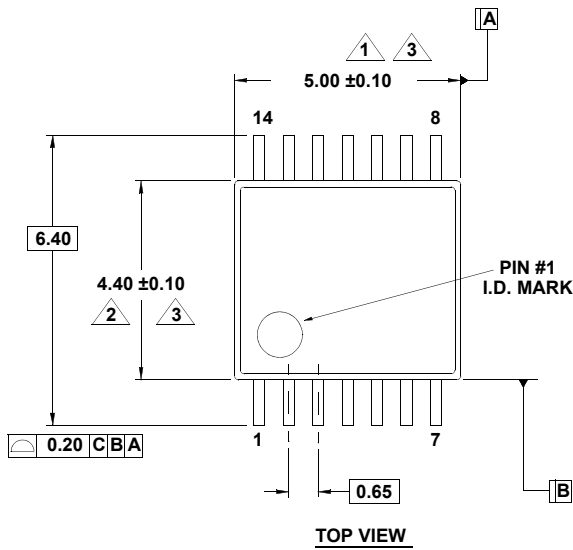

NOTES:

1. Dimension does not include mold flash, protrusions or gate burrs. Mold flash, protrusions or gate burrs shall not exceed 0.15 per side.
2. Dimension does not include interlead flash or protrusion. Interlead flash or protrusion shall not exceed 0.25 per side.
3. Dimensions are measured at datum plane H.
4. Dimensioning and tolerancing per ASME Y14.5M-1994.
5. Dimension does not include dambar protrusion. Allowable protrusion shall be 0.80mm total in excess of dimension at maximum material condition. Minimum space between protrusion and adjacent lead is 0.07mm.
6. Dimension in ( ) are for reference only.
7. Conforms to JEDEC MO-153, variation AB-1.

**Ceramic Metal Seal Flatpack Packages (Flatpack)**

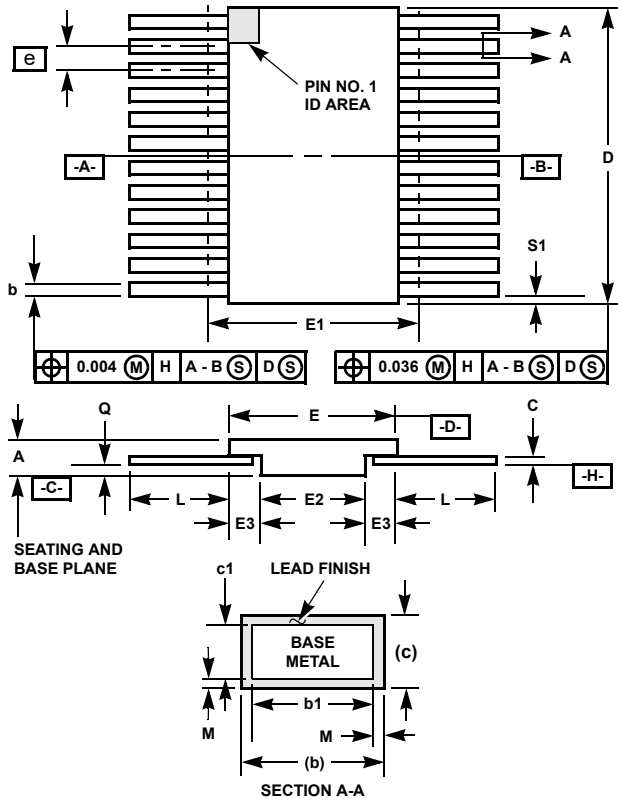

**NOTES:**

1. Index area: A notch or a pin one identification mark shall be located adjacent to pin one and shall be located within the shaded area shown. The manufacturer's identification shall not be used as a pin one identification mark. Alternately, a tab (dimension k) may be used to identify pin one.
2. If a pin one identification mark is used in addition to a tab, the limits of dimension k do not apply.
3. This dimension allows for off-center lid, meniscus, and glass overrun.
4. Dimensions b1 and c1 apply to lead base metal only. Dimension M applies to lead plating and finish thickness. The maximum limits of lead dimensions b and c or M shall be measured at the centroid of the finished lead surfaces, when solder dip or tin plate lead finish is applied.
5. N is the maximum number of terminal positions.
6. Measure dimension S1 at all four corners.
7. For bottom-brazed lead packages, no organic or polymeric materials shall be molded to the bottom of the package to cover the leads.
8. Dimension Q shall be measured at the point of exit (beyond the meniscus) of the lead from the body. Dimension Q minimum shall be reduced by 0.0015 inch (0.038mm) maximum when solder dip lead finish is applied.
9. Dimensioning and tolerancing per ANSI Y14.5M - 1982.
10. Controlling dimension: INCH.

**K14.A**

MIL-STD-1835 CDFP3-F14 (F-2A, CONFIGURATION B)  
14 LEAD CERAMIC METAL SEAL FLATPACK PACKAGE

| SYMBOL | INCHES    |        | MILLIMETERS |      | NOTES |
|--------|-----------|--------|-------------|------|-------|
|        | MIN       | MAX    | MIN         | MAX  |       |
| A      | 0.045     | 0.115  | 1.14        | 2.92 | -     |
| b      | 0.015     | 0.022  | 0.38        | 0.56 | -     |
| b1     | 0.015     | 0.019  | 0.38        | 0.48 | -     |
| c      | 0.004     | 0.009  | 0.10        | 0.23 | -     |
| c1     | 0.004     | 0.006  | 0.10        | 0.15 | -     |
| D      | -         | 0.390  | -           | 9.91 | 3     |
| E      | 0.235     | 0.260  | 5.97        | 6.60 | -     |
| E1     | -         | 0.290  | -           | 7.11 | 3     |
| E2     | 0.125     | -      | 3.18        | -    | -     |
| E3     | 0.030     | -      | 0.76        | -    | 7     |
| e      | 0.050 BSC |        | 1.27 BSC    |      | -     |
| k      | 0.008     | 0.015  | 0.20        | 0.38 | 2     |
| L      | 0.270     | 0.370  | 6.86        | 9.40 | -     |
| Q      | 0.026     | 0.045  | 0.66        | 1.14 | 8     |
| S1     | 0.005     | -      | 0.13        | -    | 6     |
| M      | -         | 0.0015 | -           | 0.04 | -     |
| N      | 14        |        | 14          |      | -     |

Rev. 0 5/18/94

For the most recent package outline drawing, see [K14.A](#).

## Notice

1. Descriptions of circuits, software and other related information in this document are provided only to illustrate the operation of semiconductor products and application examples. You are fully responsible for the incorporation or any other use of the circuits, software, and information in the design of your product or system. Renesas Electronics disclaims any and all liability for any losses and damages incurred by you or third parties arising from the use of these circuits, software, or information.
  2. Renesas Electronics hereby expressly disclaims any warranties against and liability for infringement or any other claims involving patents, copyrights, or other intellectual property rights of third parties, by or arising from the use of Renesas Electronics products or technical information described in this document, including but not limited to, the product data, drawings, charts, programs, algorithms, and application examples.
  3. No license, express, implied or otherwise, is granted hereby under any patents, copyrights or other intellectual property rights of Renesas Electronics or others.
  4. You shall not alter, modify, copy, or reverse engineer any Renesas Electronics product, whether in whole or in part. Renesas Electronics disclaims any and all liability for any losses or damages incurred by you or third parties arising from such alteration, modification, copying or reverse engineering.
  5. Renesas Electronics products are classified according to the following two quality grades: "Standard" and "High Quality". The intended applications for each Renesas Electronics product depends on the product's quality grade, as indicated below.
    - "Standard": Computers; office equipment; communications equipment; test and measurement equipment; audio and visual equipment; home electronic appliances; machine tools; personal electronic equipment; industrial robots; etc.
    - "High Quality": Transportation equipment (automobiles, trains, ships, etc.); traffic control (traffic lights); large-scale communication equipment; key financial terminal systems; safety control equipment; etc.Unless expressly designated as a high reliability product or a product for harsh environments in a Renesas Electronics data sheet or other Renesas Electronics document, Renesas Electronics products are not intended or authorized for use in products or systems that may pose a direct threat to human life or bodily injury (artificial life support devices or systems; surgical implantations; etc.), or may cause serious property damage (space system; undersea repeaters; nuclear power control systems; aircraft control systems; key plant systems; military equipment; etc.). Renesas Electronics disclaims any and all liability for any damages or losses incurred by you or any third parties arising from the use of any Renesas Electronics product that is inconsistent with any Renesas Electronics data sheet, user's manual or other Renesas Electronics document.
  6. When using Renesas Electronics products, refer to the latest product information (data sheets, user's manuals, application notes, "General Notes for Handling and Using Semiconductor Devices" in the reliability handbook, etc.), and ensure that usage conditions are within the ranges specified by Renesas Electronics with respect to maximum ratings, operating power supply voltage range, heat dissipation characteristics, installation, etc. Renesas Electronics disclaims any and all liability for any malfunctions, failure or accident arising out of the use of Renesas Electronics products outside of such specified ranges.
  7. Although Renesas Electronics endeavors to improve the quality and reliability of Renesas Electronics products, semiconductor products have specific characteristics, such as the occurrence of failure at a certain rate and malfunctions under certain use conditions. Unless designated as a high reliability product or a product for harsh environments in a Renesas Electronics data sheet or other Renesas Electronics document, Renesas Electronics products are not subject to radiation resistance design. You are responsible for implementing safety measures to guard against the possibility of bodily injury, injury or damage caused by fire, and/or danger to the public in the event of a failure or malfunction of Renesas Electronics products, such as safety design for hardware and software, including but not limited to redundancy, fire control and malfunction prevention, appropriate treatment for aging degradation or any other appropriate measures. Because the evaluation of microcomputer software alone is very difficult and impractical, you are responsible for evaluating the safety of the final products or systems manufactured by you.
  8. Please contact a Renesas Electronics sales office for details as to environmental matters such as the environmental compatibility of each Renesas Electronics product. You are responsible for carefully and sufficiently investigating applicable laws and regulations that regulate the inclusion or use of controlled substances, including without limitation, the EU RoHS Directive, and using Renesas Electronics products in compliance with all these applicable laws and regulations. Renesas Electronics disclaims any and all liability for damages or losses occurring as a result of your noncompliance with applicable laws and regulations.
  9. Renesas Electronics products and technologies shall not be used for or incorporated into any products or systems whose manufacture, use, or sale is prohibited under any applicable domestic or foreign laws or regulations. You shall comply with any applicable export control laws and regulations promulgated and administered by the governments of any countries asserting jurisdiction over the parties or transactions.
  10. It is the responsibility of the buyer or distributor of Renesas Electronics products, or any other party who distributes, disposes of, or otherwise sells or transfers the product to a third party, to notify such third party in advance of the contents and conditions set forth in this document.
  11. This document shall not be reprinted, reproduced or duplicated in any form, in whole or in part, without prior written consent of Renesas Electronics.
  12. Please contact a Renesas Electronics sales office if you have any questions regarding the information contained in this document or Renesas Electronics products.
- (Note1) "Renesas Electronics" as used in this document means Renesas Electronics Corporation and also includes its directly or indirectly controlled subsidiaries.
- (Note2) "Renesas Electronics product(s)" means any product developed or manufactured by or for Renesas Electronics.

(Rev.4.0-1 November 2017)

## Corporate Headquarters

TOYOSU FORESIA, 3-2-24 Toyosu,  
Koto-ku, Tokyo 135-0061, Japan  
[www.renesas.com](http://www.renesas.com)

## Contact Information

For further information on a product, technology, the most up-to-date version of a document, or your nearest sales office, please visit:  
[www.renesas.com/contact/](http://www.renesas.com/contact/)

## Trademarks

Renesas and the Renesas logo are trademarks of Renesas Electronics Corporation. All trademarks and registered trademarks are the property of their respective owners.

## Looking for pricing, stock, or lifecycle information?

Click below to explore more details on WIN SOURCE:

-  [View ISL28217FBBZ on WIN SOURCE](#)
-  [Renesas Electronics America](#) Information

## Optimize Your Supply Chain with WIN SOURCE Solutions

-  Global Sourcing Solution
-  Obsolete Management
-  Cost Control Management
-  Shortage Management
-  Alternative Solution
-  Excess Inventory Management