



**THE DATASHEET OF
7164L55DB**



Features

- ◆ High-speed address/chip select access time
 - Commercial: 20/25ns (max.)
 - Industrial: 20/25ns (max.)
 - Military: 20/25/35/45/55/70/85/100ns (max.)
- ◆ Low power consumption
- ◆ Battery backup operation - 2V data retention voltage (L Version only)
- ◆ Produced with advanced CMOS high-performance technology
- ◆ Inputs and outputs directly TTL-compatible
- ◆ Three-state outputs
- ◆ Available in 28-pin DIP, CERDIP and SOJ
- ◆ Military product compliant to MIL-STD-883, Class B
- ◆ Industrial temperature range (-40°C to +85°C) is available for selected speeds
- ◆ Green parts available, see ordering information

Description

The IDT7164 is a 65,536 bit high-speed static RAM organized as 8K x 8. It is fabricated using high-performance, high-reliability CMOS technology.

Address access times as fast as 20ns are available and the circuit offers a reduced power standby mode. When CS₁ goes HIGH or CS₂ goes LOW, the circuit will automatically go to, and remain in, a low-power standby mode. The low-power (L) version also offers a battery backup data retention capability at power supply levels as low as 2V.

All inputs and outputs of the IDT7164 are TTL-compatible and operation is from a single 5V supply, simplifying system designs. Fully static asynchronous circuitry is used, requiring no clocks or refreshing for operation.

The IDT7164 is packaged in a 28-pin 300 mil CERDIP, a 28-pin 600 mil CERDIP, 300mil Plastic DIP and 300mil SOJ

Military grade product is manufactured in compliance with MIL-STD-883, Class B, making it ideally suited to military temperature applications demanding the highest level of performance and reliability.

Functional Block Diagram

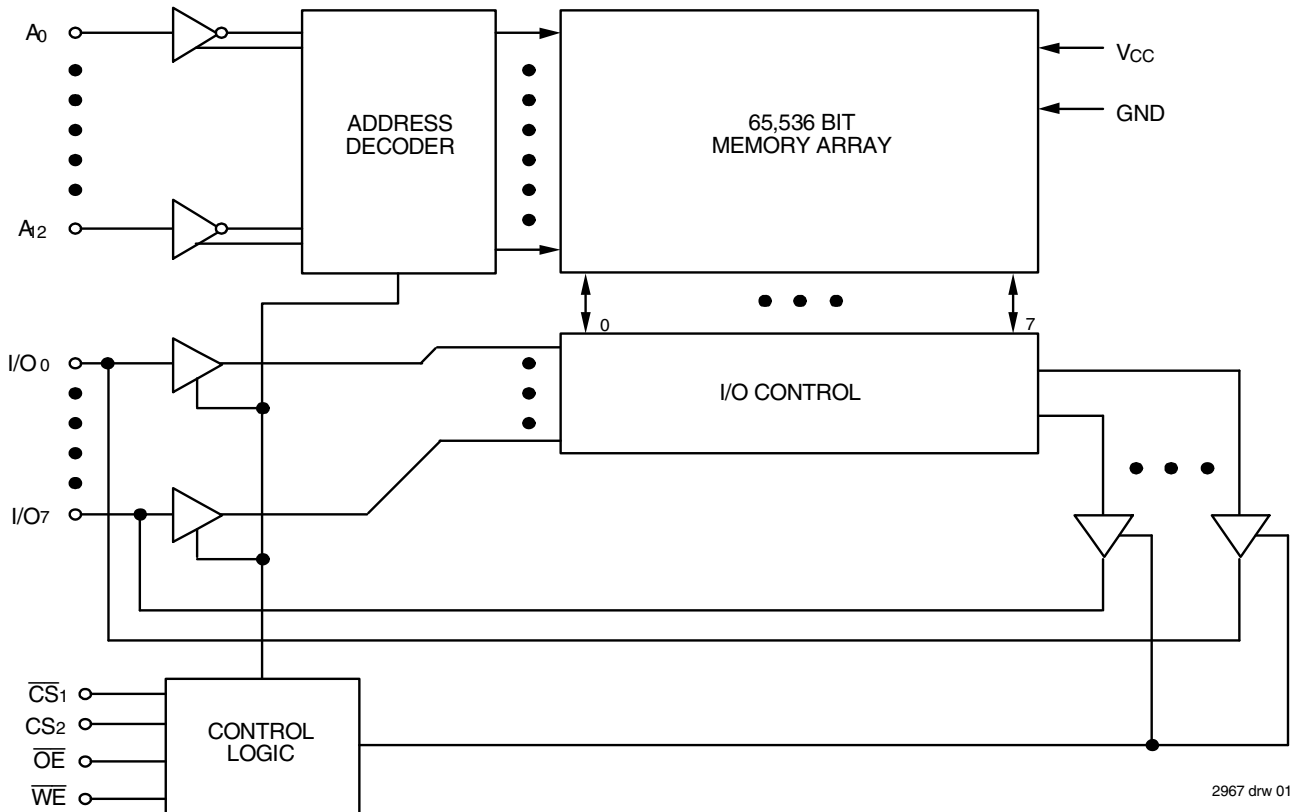

Pin Configurations⁽¹⁾

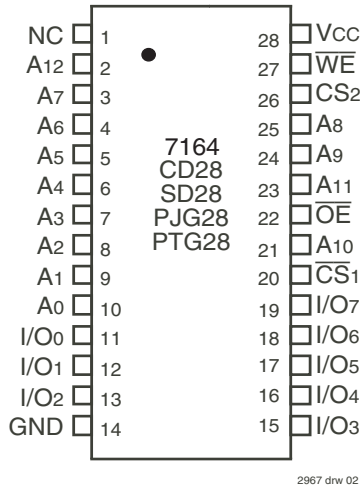

DIP/SOJ
Top View

NOTE:

- This text does not indicate orientation of actual part-marking.

Pin Descriptions

Name	Description
A0 - A12	Address
I/O0 - I/O7	Data Input/Output
$\overline{CS1}$	Chip Select
CS2	Chip Select
\overline{WE}	Write Enable
\overline{OE}	Output Enable
GND	Ground
Vcc	Power

2967 tbl 01

Recommended DC Operating Conditions

Symbol	Parameter	Min.	Typ.	Max.	Unit
Vcc	Supply Voltage	4.5	5.0	5.5	V
GND	Ground	0	0	0	V
V _{IH}	Input HIGH Voltage	2.2	—	Vcc + 0.5	V
V _{IL}	Input LOW Voltage	-0.5 ⁽¹⁾	—	0.8	V

2967 tbl 05

NOTE:

- V_{IL} (min.) = -1.5V for pulse width less than 10ns, once per cycle.

Absolute Maximum Ratings⁽¹⁾

Symbol	Rating	Com'l.	Mil.	Unit
V _{TERM} ⁽²⁾	Terminal Voltage with Respect to GND	-0.5 to +7.0	-0.5 to +7.0	V
T _A	Operating Temperature	0 to +70	-55 to +125	°C
T _{BIAS}	Temperature Under Bias	-55 to +125	-65 to +135	°C
T _{STG}	Storage Temperature	-55 to +125	-65 to +150	°C
P _T	Power Dissipation	1.0	1.0	W
I _{OUT}	DC Output Current	50	50	mA

2967 tbl 02

NOTES:

- Stresses greater than those listed under ABSOLUTE MAXIMUM RATINGS may cause permanent damage to the device. This is a stress rating only and functional operation of the device at these or any other conditions above those indicated in the operational sections of this specification is not implied. Exposure to absolute maximum rating conditions for extended periods may affect reliability.
- V_{TERM} must not exceed Vcc + 0.5V.

Truth Table^(1,2,3)

\overline{WE}	$\overline{CS1}$	CS2	\overline{OE}	I/O	Function
X	H	X	X	High-Z	Deselected - Standby (I _{SB})
X	X	L	X	High-Z	Deselected - Standby (I _{SB})
X	V _{Hc}	V _{Hc} or V _{Lc}	X	High-Z	Deselected - Standby (I _{SB1})
X	X	V _{Lc}	X	High-Z	Deselected - Standby (I _{SB1})
H	L	H	H	High-Z	Output Disabled
H	L	H	L	DATA _{OUT}	Read Data
L	L	H	X	DATA _{IN}	Write Data

2967 tbl 03

NOTES:

- CS2 will power-down $\overline{CS1}$, but $\overline{CS1}$ will not power-down CS2.
- H = V_{IH}, L = V_{IL}, X = don't care.
- V_{Lc} = 0.2V, V_{Hc} = Vcc - 0.2V

Recommended Operating Temperature and Supply Voltage

Grade	Temperature	GND	Vcc
Military	-55°C to +125°C	0V	5V ± 10%
Industrial	-40°C to +85°C	0V	5V ± 10%
Commercial	0°C to +70°C	0V	5V ± 10%

2967 tbl 04

Capacitance ($T_A = +25^\circ\text{C}$, $f = 1.0\text{MHz}$)

Symbol	Parameter ⁽¹⁾	Conditions	Max.	Unit
C _{IN}	Input Capacitance	V _{IN} = 0V	8	pF
C _{VO}	I/O Capacitance	V _{OUT} = 0V	8	pF

2967 tbl 06

NOTE:

1. This parameter is determined by device characterization, but is not production tested.

DC Electrical Characteristics⁽¹⁾ (V_{CC} = 5.0V ± 10%, V_{LC} = 0.2V, V_{HC} = V_{CC} - 0.2V)

Symbol	Parameter	Power	7164S20 7164L20			7164S25 7164L25			Unit
			Com'l.	Ind.	Mil.	Com'l.	Ind.	Mil.	
ICC1	Operating Power Supply Current CS ₁ = V _{IL} , CS ₂ = V _{IH} , Outputs Open V _{CC} = Max., f = 0 ⁽²⁾	S	100	110	110	90	110	110	mA
		L	90	100	100	90	100	100	
ICC2	Dynamic Operating Current CS ₁ = V _{IL} , CS ₂ = V _{IH} , Outputs Open V _{CC} = Max., f = f _{MAX} ⁽²⁾	S	170	170	180	170	170	180	mA
		L	150	150	160	150	150	160	
ISB	Standby Power Supply Current (TTL Level), CS ₁ ≥ V _{IH} , CS ₂ ≤ V _{IL} , Outputs Open, V _{CC} = Max., f = f _{MAX} ⁽²⁾	S	20	20	20	20	20	20	mA
		L	3	3	5	3	3	5	
ISB1	Full Standby Power Supply Current (CMOS Level), f = 0 ⁽²⁾ , V _{CC} = Max. 1. CS ₁ ≥ V _{HC} and CS ₂ ≥ V _{HC} , or 2. CS ₂ ≤ V _{LC}	S	15	15	20	15	15	20	mA
		L	0.2	0.2	1	0.2	0.2	1	

2967 tbl 07

Symbol	Parameter	Power	7164S35 7164L35	7164S45 7164L45	7164S55 7164L55	7164S70 7164L70	7164S85/100 7164L85/100	Unit
			Mil.	Mil.	Mil.	Mil.	Mil.	
ICC1	Operating Power Supply Current CS ₁ = V _{IL} , CS ₂ = V _{IH} , Outputs Open V _{CC} = Max., f = 0 ⁽²⁾	S	100	100	100	100	100	mA
		L	90	90	90	90	90	
ICC2	Dynamic Operating Current CS ₁ = V _{IL} , CS ₂ = V _{IH} , Outputs Open V _{CC} = Max., f = f _{MAX} ⁽²⁾	S	160	160	160	160	160	mA
		L	140	130	125	120	120	
ISB	Standby Power Supply Current (TTL Level), CS ₁ ≥ V _{IH} , CS ₂ ≤ V _{IL} , Outputs Open, V _{CC} = Max., f = f _{MAX} ⁽²⁾	S	20	20	20	20	20	mA
		L	5	5	5	5	5	
ISB1	Full Standby Power Supply Current (CMOS Level), f = 0 ⁽²⁾ , V _{CC} = Max. 1. CS ₁ ≥ V _{HC} and CS ₂ ≥ V _{HC} , or 2. CS ₂ ≤ V _{LC}	S	20	20	20	20	20	mA
		L	1	1	1	1	1	

2967 tbl 08

NOTES:

1. All values are maximum guaranteed values.
2. f_{MAX} = 1/TRC (all address inputs are cycling at f_{MAX}); f = 0 means no address input lines are changing.

DC Electrical Characteristics (V_{CC} = 5.0V ± 10%)

Symbol	Parameter	Test Conditions	IDT7164S		IDT7164L		Unit	
			Min.	Max.	Min.	Max.		
I _{LI}	Input Leakage Current	V _{CC} = Max., V _{IN} = GND to V _{CC}	MIL. COM'L. & IND	— 5	10 5	— 2	5 2	μA
I _{LO}	Output Leakage Current	V _{CC} = Max., $\overline{CS}_1 = V_H$, V _{OUT} = GND to V _{CC}	MIL. COM'L. & IND	— 5	10 5	— 2	5 2	μA
V _{OL}	Output Low Voltage	I _{OL} = 8mA, V _{CC} = Min.	—	0.4	—	0.4	V	
		I _{OL} = 10mA, V _{CC} = Min.	—	0.5	—	0.5		
V _{OH}	Output High Voltage	I _{OH} = -4mA, V _{CC} = Min.	2.4	—	2.4	—	V	

2967 tbl 09

Data Retention Characteristics Over All Temperature Ranges (L Version Only) (V_{LC} = 0.2V, V_{HC} = V_{CC} - 0.2V)

Symbol	Parameter	Test Condition	Min.	Typ. ⁽¹⁾ V _{CC} @		Max. V _{CC} @		Unit
				2.0V	3.0V	2.0V	3.0V	
V _{DR}	V _{CC} for Data Retention	—	2.0	—	—	—	—	V
I _{CCDR}	Data Retention Current	MIL. COM'L. & IND	— —	10 10	15 15	200 60	300 90	μA
t _{CDR} ⁽³⁾	Chip Deselect to Data Retention Time	1. $\overline{CS}_1 \geq V_{HC}$ CS ₂ ≥ V _{HC} , or 2. CS ₂ ≤ V _{LC}	0	—	—	—	—	ns
t _R ⁽³⁾	Operation Recovery Time		t _{RC} ⁽²⁾	—	—	—	—	ns
I _{LI} ⁽³⁾	Input Leakage Current		—	—	—	2	2	μA

2967 tbl 10

NOTES:

1. T_A = +25°C.
2. t_{RC} = Read Cycle Time.
3. This parameter is guaranteed by device characterization, but is not production tested.

AC Test Conditions

Input Pulse Levels	GND to 3.0V
Input Rise/Fall Times	5ns
Input Timing Reference Levels	1.5V
Output Reference Levels	1.5V
AC Test Load	See Figures 1 and 2

2967 tbl 11

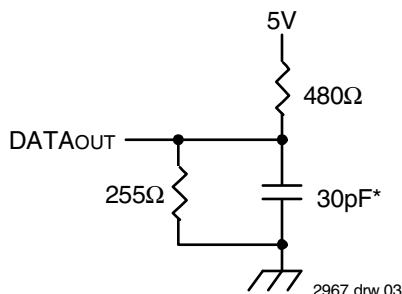

Figure 1. AC Test Load

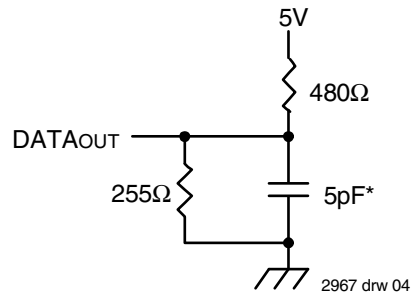

Figure 2. AC Test Load

(for t_{CLZ1}, t_{CLZ2}, t_{OLZ}, t_{CHZ1}, t_{CHZ2}, t_{OHZ}, t_{OW}, and t_{WHZ})

*Includes scope and jig capacitances

AC Electrical Characteristics (V_{CC} = 5.0V ± 10%, All Temperature Ranges)

Symbol	Parameter	7164S20 7164L20		7164S25 7164L25		Unit
		Min.	Max.	Min.	Max.	
Read Cycle						
t _{RC}	Read Cycle Time	20	—	25	—	ns
t _{AA}	Address Access Time	—	19	—	25	ns
t _{ACS1} ⁽¹⁾	Chip Select-1 Access Time	—	20	—	25	ns
t _{ACS2} ⁽¹⁾	Chip Select-2 Access Time	—	25	—	30	ns
t _{CLZ1,2} ⁽²⁾	Chip Select-1, 2 to Output in Low-Z	5	—	5	—	ns
t _{OE}	Output Enable to Output Valid	—	8	—	12	ns
t _{OLZ} ⁽²⁾	Output Enable to Output in Low-Z	0	—	0	—	ns
t _{CHZ1,2} ⁽²⁾	Chip Select-1,2 to Output in High-Z	—	9	—	13	ns
t _{OHZ} ⁽²⁾	Output Disable to Output in High-Z	—	8	—	10	ns
t _{OH}	Output Hold from Address Change	5	—	5	—	ns
t _{PU} ⁽²⁾	Chip Select to Power Up Time	0	—	0	—	ns
t _{PD} ⁽²⁾	Chip Deselect to Power Down Time	—	20	—	25	ns
Write Cycle						
t _{WC}	Write Cycle Time	20	—	25	—	ns
t _{CW1,2}	Chip Select to End-of-Write	15	—	18	—	ns
t _{AW}	Address Valid to End-of-Write	15	—	18	—	ns
t _{AS}	Address Set-up Time	0	—	0	—	ns
t _{WP}	Write Pulse Width	15	—	21	—	ns
t _{WR1}	Write Recovery Time ($\overline{CS}_1, \overline{WE}$)	0	—	0	—	ns
t _{WR2}	Write Recovery Time (CS ₂)	5	—	5	—	ns
t _{WHZ} ⁽²⁾	Write Enable to Output in High-Z	—	8	—	10	ns
t _{DW}	Data to Write Time Overlap	10	—	13	—	ns
t _{DH1}	Data Hold from Write Time ($\overline{CS}_1, \overline{WE}$)	0	—	0	—	ns
t _{DH2}	Data Hold from Write Time (CS ₂)	5	—	5	—	ns
t _{OW} ⁽²⁾	Output Active from End-of-Write	4	—	4	—	ns

2967 tbl 12

NOTES:

- Both chip selects must be active for the device to be selected.
- This parameter is guaranteed by device characterization, but is not production tested.

AC Electrical Characteristics (con't.) (V_{CC} = 5.0V ± 10%, Military Temperature Ranges)

Symbol	Parameter	7164S35 7164L35		7164S45 7164L45		7164S55 7164L55		7164S70 7164L70		7164S85/100 7164L85/100		Unit
		Max.	Min.	Min.	Max.	Min.	Max.	Min.	Max.	Min.	Max.	
Read Cycle												
t _{RC}	Read Cycle Time	35	—	45	—	55	—	70	—	85/100	—	ns
t _{AA}	Address Access Time	—	35	—	45	—	55	—	70	—	85/100	ns
t _{ACS1} ⁽¹⁾	Chip Select-1 Access Time	—	35	—	45	—	55	—	70	—	85/100	ns
t _{ACS2} ⁽¹⁾	Chip Select-2 Access Time	—	40	—	45	—	55	—	70	—	85/100	ns
t _{CLZ1,2} ⁽²⁾	Chip Select-1, 2 to Output in Low-Z	5	—	5	—	5	—	5	—	5	—	ns
t _{OE}	Output Enable to Output Valid	—	18	—	25	—	30	—	35	—	40	ns
t _{OLZ} ⁽²⁾	Output Enable to Output in Low-Z	0	—	0	—	0	—	0	—	0	—	ns
t _{CHZ1,2} ⁽²⁾	Chip Select-1,2 to Output in High-Z	—	15	—	20	—	25	—	30	—	35	ns
t _{OHZ} ⁽²⁾	Output Disable to Output in High-Z	—	15	—	20	—	25	—	30	—	35	ns
t _{OH}	Output Hold from Address Change	5	—	5	—	5	—	5	—	5	—	ns
t _{PU} ⁽²⁾	Chip Select to Power Up Time	0	—	0	—	0	—	0	—	0	—	ns
t _{PD} ⁽²⁾	Chip Deselect to Power Down Time	—	35	—	45	—	55	—	70	—	85/100	ns
Write Cycle												
t _{WC}	Write Cycle Time	35	—	45	—	55	—	70	—	85/100	—	ns
t _{CW1,2}	Chip Select to End-of-Write	25	—	33	—	50	—	60	—	75	—	ns
t _{AW}	Address Valid to End-of-Write	25	—	33	—	50	—	60	—	75	—	ns
t _{AS}	Address Set-up Time	0	—	0	—	0	—	0	—	0	—	ns
t _{WP}	Write Pulse Width	25	—	25	—	50	—	60	—	75	—	ns
t _{WR1}	Write Recovery Time ($\overline{CS}_1, \overline{WE}$)	0	—	0	—	0	—	0	—	0	—	ns
t _{WR2}	Write Recovery Time (CS ₂)	5	—	5	—	5	—	5	—	5	—	ns
t _{WHZ} ⁽²⁾	Write Enable to Output in High-Z	—	14	—	18	—	25	—	30	—	35	ns
t _{DW}	Data to Write Time Overlap	15	—	20	—	25	—	30	—	35	—	ns
t _{DH1}	Data Hold from Write Time ($\overline{CS}_1, \overline{WE}$)	0	—	0	—	0	—	0	—	0	—	ns
t _{DH2}	Data Hold from Write Time (CS ₂)	5	—	5	—	5	—	5	—	5	—	ns
t _{OW} ⁽²⁾	Output Active from End-of-Write	4	—	4	—	4	—	4	—	4	—	ns

2967 tbl 13

NOTES:

- Both chip selects must be active for the device to be selected.
- This parameter is guaranteed by device characterization, but is not production tested.

Timing Waveform of Read Cycle No. 1⁽¹⁾

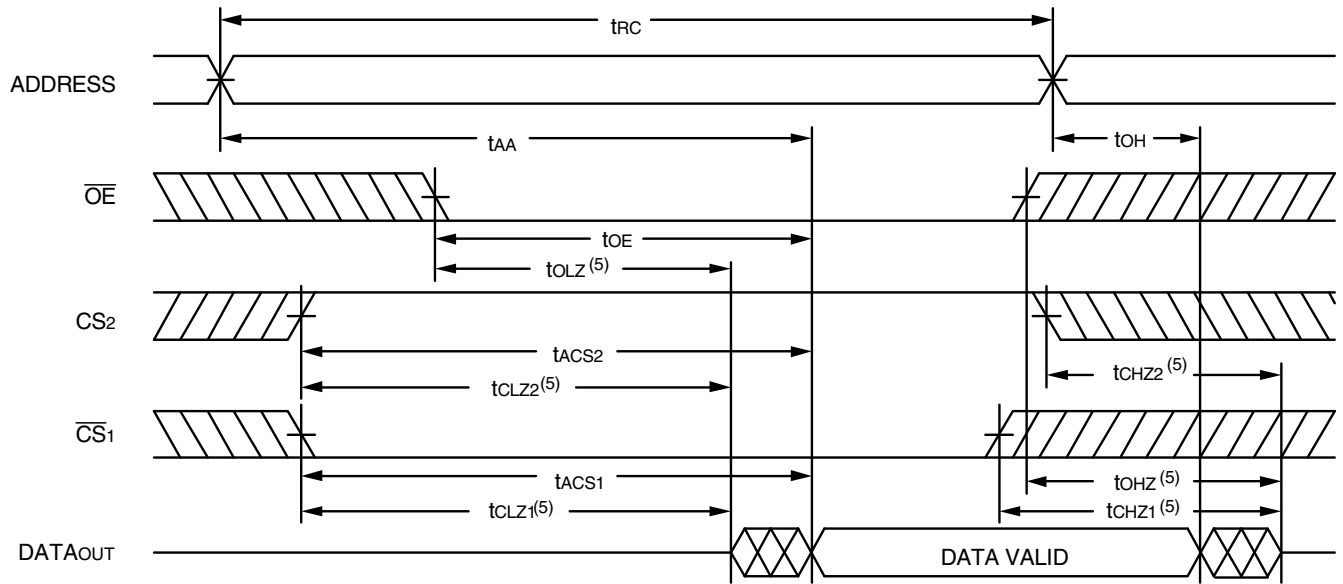

2967 drw 05

Timing Waveform of Read Cycle No. 2^(1,2,4)

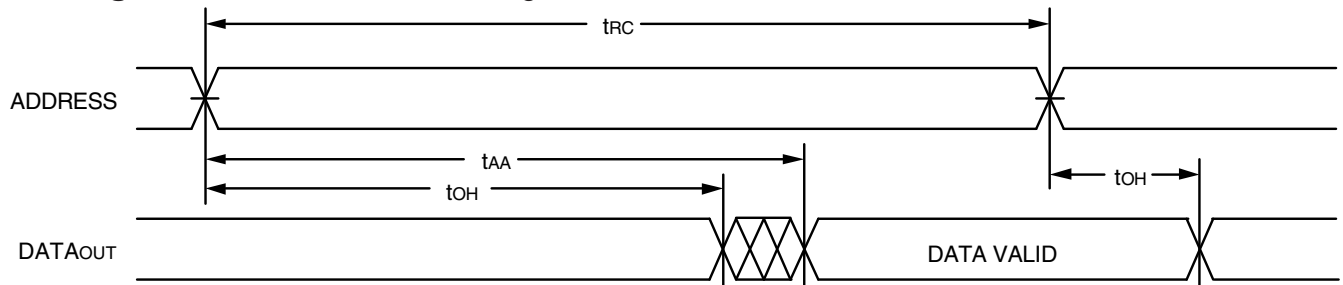

2967 drw 06

Timing Waveform of Read Cycle No. 3^(1,3,4)

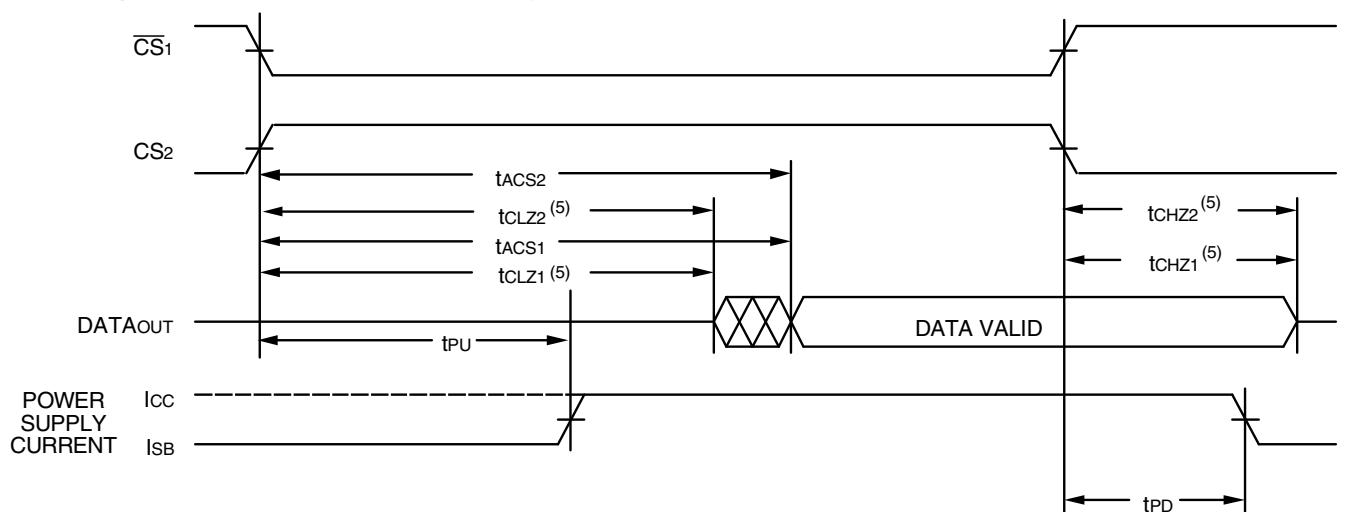

NOTES:

1. \overline{WE} is HIGH for Read cycle.
2. Device is continuously selected, \overline{CS}_1 is LOW, CS_2 is HIGH.
3. Address valid prior to or coincident with \overline{CS}_1 transition LOW and CS_2 transition HIGH.
4. \overline{OE} is LOW.
5. Transition is measured $\pm 200mV$ from steady state.

2967 drw 07

Timing Waveform of Write Cycle No. 1 (\overline{WE} Controlled Timing)^(1,5)

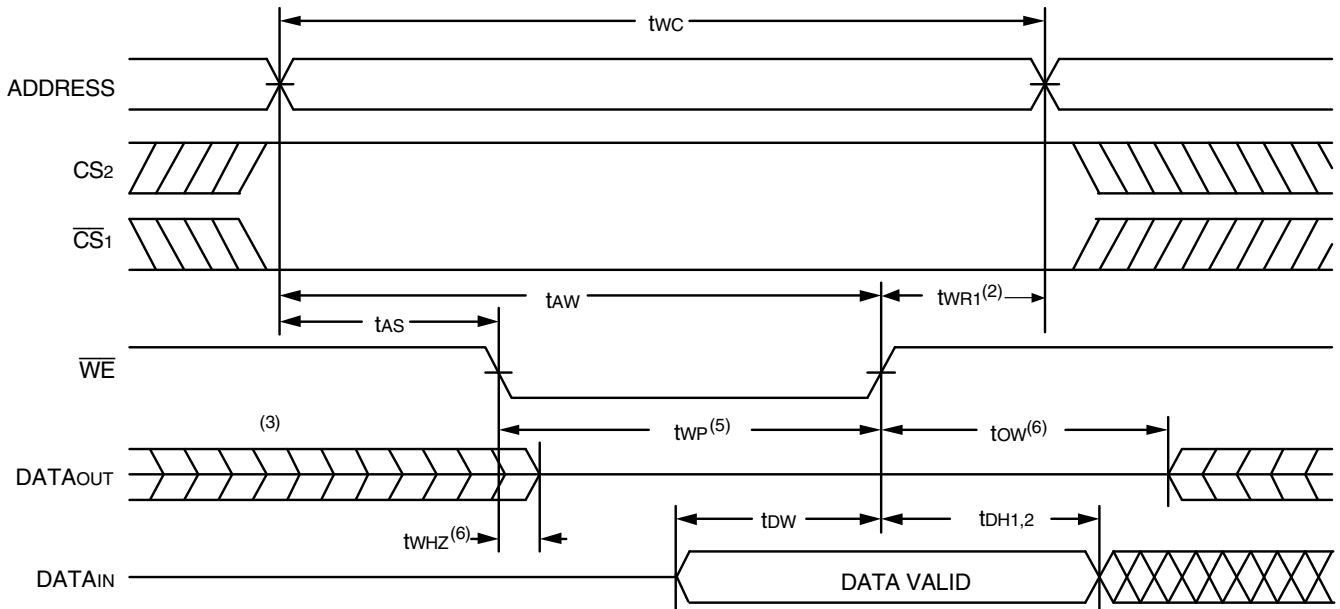

2967 drw 08

Timing Waveform of Write Cycle No. 2 (\overline{CS} Controlled Timing)⁽¹⁾

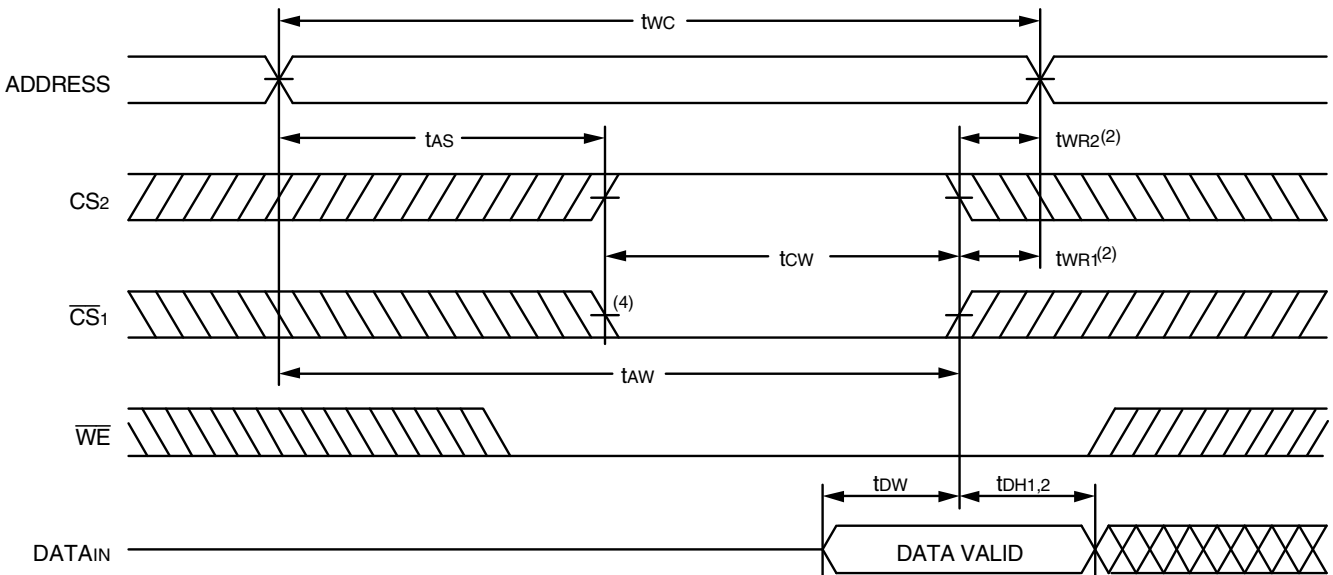

2967 drw 09

NOTES:

1. A write occurs during the overlap of a LOW \overline{WE} , a LOW $\overline{CS1}$ and a HIGH $CS2$.
2. $tWR1,2$ is measured from the earlier of $\overline{CS1}$ or \overline{WE} going HIGH or $CS2$ going LOW to the end of the write cycle.
3. During this period, I/O pins are in the output state so that the input signals must not be applied.
4. If the $\overline{CS1}$ LOW transition or $CS2$ HIGH transition occurs simultaneously with or after the \overline{WE} LOW transition, the outputs remain in a high-impedance state.
5. \overline{OE} is continuously HIGH. If \overline{OE} is LOW during a \overline{WE} controlled write cycle, the write pulse width must be the larger of tWP or $(tWHZ + tWP)$ to allow the I/O drivers to turn off and data to be placed on the bus for the required tOW . If \overline{OE} is HIGH during a \overline{WE} controlled write cycle, this requirement does not apply and the minimum write pulse width is as short as the specified tWP .
6. Transition is measured $\pm 200mV$ from steady state.

Low Vcc Data Retention Waveform

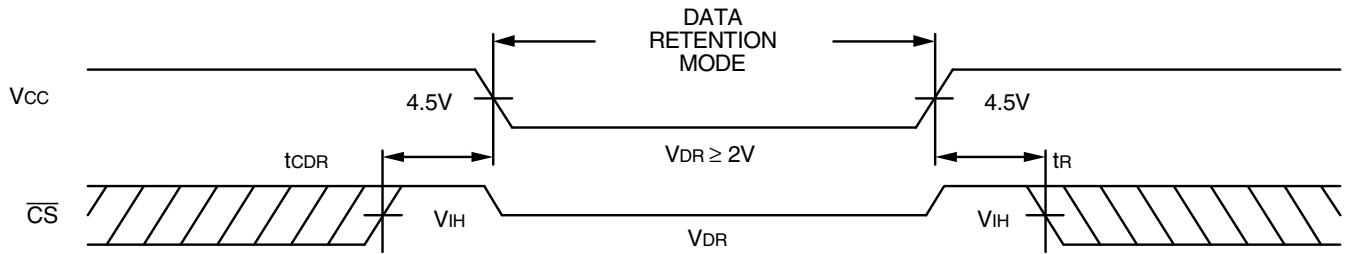

2967 drw 10

Ordering Information

7164	X	XX	XXX	X	X	X	
Device Type	Power	Speed	Package		Process/ Temperature Range		
						Blank 8	Tube Tape and Reel
						Blank I ⁽¹⁾ B	Commercial (0°C to +70°C) Industrial (-40°C to +85°C) Military (-55°C to +125°C) Compliant with MIL-STD-883, Class B
						G ⁽²⁾	Green
						Y TP D TD	300 mil SOJ (PJG28) 300 mil Plastic DIP (PTG28) 600 mil CERDIP (CD28) 300 mil CERDIP (SD28)
						20 25 35 45 55 70 85 100	Commercial, Industrial & Military Commercial, Industrial & Military Military Only Military Only Military Only Military Only Military Only Military Only
						S L	Standard Power Low Power

} Speed in nanoseconds

2967 drw 11

NOTES:

- Contact your local sales office for industrial temp range for other speeds, packages and powers.
- Green parts available. For specific speeds, packages and powers contact your local sales office.

Orderable Part Information

Speed (ns)	Orderable Part ID	Pkg. Code	Pkg. Type	Temp. Grade
20	7164L20DB	CD28	CDIP	M
	7164L20TDB	SD28	CDIP	M
	7164L20YG	PJG28	SOJ	C
	7164L20YG8	PJG28	SOJ	C
	7164L20YGI	PJG28	SOJ	I
	7164L20YG18	PJG28	SOJ	I
25	7164L25DB	CD28	CDIP	M
	7164L25TDB	SD28	CDIP	M
	7164L25YG	PJG28	SOJ	C
	7164L25YG8	PJG28	SOJ	C
	7164L25YGI	PJG28	SOJ	I
	7164L25YG18	PJG28	SOJ	I
35	7164L35DB	CD28	CDIP	M
	7164L35TDB	SD28	CDIP	M
45	7164L45DB	CD28	CDIP	M
	7164L45TDB	SD28	CDIP	M
55	7164L55DB	CD28	CDIP	M
	7164L55TDB	SD28	CDIP	M
70	7164L70DB	CD28	CDIP	M
	7164L70TDB	SD28	CDIP	M
85	7164L85DB	CD28	CDIP	M
	7164L85TDB	SD28	CDIP	M
100	7164L100DB	CD28	CDIP	M

Speed (ns)	Orderable Part ID	Pkg. Code	Pkg. Type	Temp. Grade
20	7164S20DB	CD28	CDIP	M
	7164S20TDB	SD28	CDIP	M
	7164S20TPG	PTG28	PDIP	C
	7164S20TPGI	PTG28	PDIP	I
	7164S20YG	PJG28	SOJ	C
	7164S20YG8	PJG28	SOJ	C
	7164S20YGI	PJG28	SOJ	I
	7164S20YG18	PJG28	SOJ	I
	25	7164S25DB	CD28	CDIP
7164S25TDB		SD28	CDIP	M
7164S25TPG		PTG28	PDIP	C
7164S25YG		PJG28	SOJ	C
7164S25YG8		PJG28	SOJ	C
7164S25YGI		PJG28	SOJ	I
7164S25YG18		PJG28	SOJ	I
35	7164S35DB	CD28	CDIP	M
	7164S35TDB	SD28	CDIP	M
45	7164S45DB	CD28	CDIP	M
	7164S45TDB	SD28	CDIP	M
55	7164S55DB	CD28	CDIP	M
	7164S55TDB	SD28	CDIP	M
70	7164S70DB	CD28	CDIP	M
	7164S70TDB	SD28	CDIP	M
85	7164S85DB	CD28	CDIP	M
	7164S85TDB	SD28	CDIP	M
100	7164S100DB	CD28	CDIP	M

Datasheet Document History

01/13/00		Updated to new format
	Pp. 1, 2, 3, 5, 10	Added Industrial Temperature range offerings
	Pp. 1, 3, 9	Removed commercial 70ns speed grade offering
	Pp. 1, 3, 6, 10	Added 100ns speed grade specification details
	Pg. 3	Revised notes and footnotes in DC Electrical tables
	Pp. 5, 6	Revised notes and footnotes in AC Electrical tables
	Pg. 8	Removed Note 1 from Write Cycle No. 1 and No. 2 diagrams; renumbered notes and footnotes
	Pp. 9, 10	Separated Ordering Information into commercial, industrial, and military offerings
	Pg. 11	Added Datasheet Document History
08/09/00		Not recommended for new designs
02/01/01		Removed "Not recommended for new designs"
12/07/01	Pg. 10	Add PJ28 to Industrial temperature.
09/30/04	Pg. 9,10	Added "restricted hazardous substance device" to ordering information.
11/16/06	Pg.3	Added industrial temp power limits for 20ns part. Changed power limits for 25ns part for commercial and industrial. Changed power limits for commercial and industrial for 35ns part.
	Pg.10	Added 20ns part to ordering information. Refer to PCN SR-0602-01
02/20/07	Pg. 9, 10	Added L generation die step to data sheet ordering information.
04/27/11	Pg. 1-3,5,6,9	Obsoleted 24-pin 600 mil, 15ns for Commercial and 35ns for Industrial & Commercial. Added Tape and Reel to Ordering information and updated description of Restricted hazardous substance device to Green.
10/30/13	Pg. 1	In the Description: Removed reference to IDT's fabrication and removed "the latest revision of".
12/06/16	Pg. 2	Removed half moon from the pin configuration diagram for all packages to reflect pin 1 orientation and added dot at pin 1
		Updated the package codes in the DIP/SOJ pin configuration
	Pg. 9	Updated the package codes in the Ordering Information
		Updated the BLANK designator from "Tube and Tray" to "Tube" in Ordering Information
	Pg. 1 & 9	Added standard footnotes to Ordering Information with instructions for ordering Industrial temp and Green parts
07/30/20	Pg. 1-12	Rebranded as Renesas datasheet
	Pg. 2	Updated pin configurations
	Pg.10	Added Orderable Part Information tables

IMPORTANT NOTICE AND DISCLAIMER

RENESAS ELECTRONICS CORPORATION AND ITS SUBSIDIARIES (“RENESAS”) PROVIDES TECHNICAL SPECIFICATIONS AND RELIABILITY DATA (INCLUDING DATASHEETS), DESIGN RESOURCES (INCLUDING REFERENCE DESIGNS), APPLICATION OR OTHER DESIGN ADVICE, WEB TOOLS, SAFETY INFORMATION, AND OTHER RESOURCES “AS IS” AND WITH ALL FAULTS, AND DISCLAIMS ALL WARRANTIES, EXPRESS OR IMPLIED, INCLUDING, WITHOUT LIMITATION, ANY IMPLIED WARRANTIES OF MERCHANTABILITY, FITNESS FOR A PARTICULAR PURPOSE, OR NON-INFRINGEMENT OF THIRD-PARTY INTELLECTUAL PROPERTY RIGHTS.

These resources are intended for developers who are designing with Renesas products. You are solely responsible for (1) selecting the appropriate products for your application, (2) designing, validating, and testing your application, and (3) ensuring your application meets applicable standards, and any other safety, security, or other requirements. These resources are subject to change without notice. Renesas grants you permission to use these resources only to develop an application that uses Renesas products. Other reproduction or use of these resources is strictly prohibited. No license is granted to any other Renesas intellectual property or to any third-party intellectual property. Renesas disclaims responsibility for, and you will fully indemnify Renesas and its representatives against, any claims, damages, costs, losses, or liabilities arising from your use of these resources. Renesas' products are provided only subject to Renesas' Terms and Conditions of Sale or other applicable terms agreed to in writing. No use of any Renesas resources expands or otherwise alters any applicable warranties or warranty disclaimers for these products.

(Disclaimer Rev.1.01 Jan 2024)

Corporate Headquarters

TOYOSU FORESIA, 3-2-24 Toyosu,
Koto-ku, Tokyo 135-0061, Japan
www.renesas.com

Trademarks

Renesas and the Renesas logo are trademarks of Renesas Electronics Corporation. All trademarks and registered trademarks are the property of their respective owners.

Contact Information

For further information on a product, technology, the most up-to-date version of a document, or your nearest sales office, please visit www.renesas.com/contact-us/.

Looking for pricing, stock, or lifecycle information?

Click below to explore more details on WIN SOURCE:

-  [View 7164L55DB on WIN SOURCE](#)
-  [Renesas Electronics America](#) Information

Optimize Your Supply Chain with WIN SOURCE Solutions

-  Global Sourcing Solution
-  Obsolete Management
-  Cost Control Management
-  Shortage Management
-  Alternative Solution
-  Excess Inventory Management