



**THE DATASHEET OF
ID1A-6S-2.54SFB(81)**



SIM Card Sockets

ID1 Series

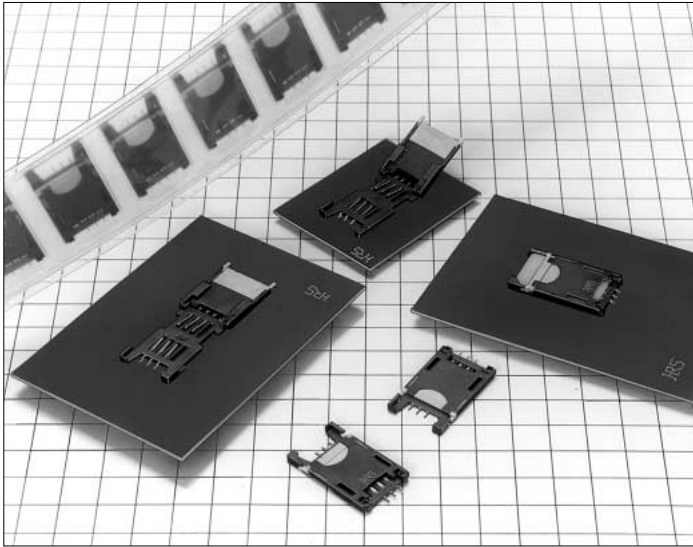

Miniature and Thin

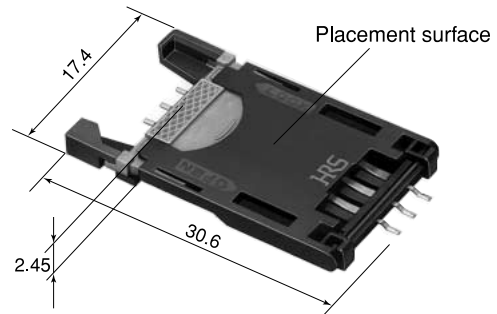

Photograph (1)

■ Features

1. Suited for Plug-in SIM Cards of the GSM Standard (11.11)

In Europe, SIM card Subscriber Identity Modules are used for subscriber identification with portable telephone terminals of the GSM system for which standards have been unified. The ID1A Series of sockets are suited for use with GSM standard (11.11) plug-in SIM cards.

2. Miniature and Thin

These sockets are miniature and thin with a height of 2.45 mm, length of 30.6 mm, and width of 17.4 mm. The weight has been reduced by 30% compared with our existing products. (See Photograph (1).)

3. Suited to Automatic Mounting

The board mounting method is of the surface mount type. In addition to the standard tray packaging specification, an embossed tape specification suited to automatic mounting is also available.

4. Prevention of Incorrect Insertion to the Board

A board-positioning boss prevents incorrect insertion to the board by means of boss position and boss diameter.

5. Slide Lock System

An original lock structure securely holds the SIM card and easy opening and closing of the card holder is another feature. (See Photograph (2).)

■ Applications

Portable terminals and equipment that use GSM Standard (11.11) plug-in SIM cards.

Slide Lock System

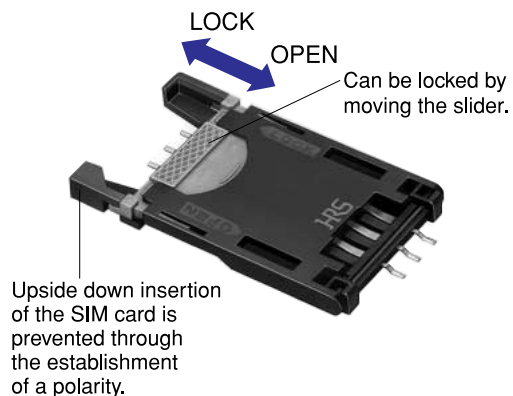

Photograph (2)

Structure and Names of the Parts

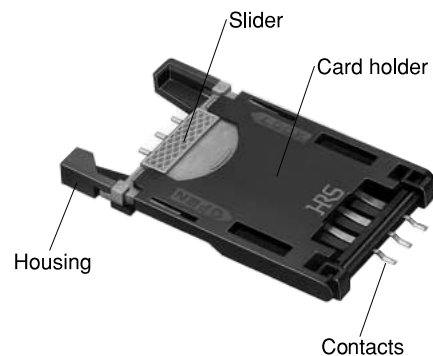

Photograph (3)

■Product Specifications

Rating	Current rating 1 A	Operating temperature -30°C to +80°C (NOTE 1)	Storage temperature -10°C to +60°C (NOTE 2)
	Voltage rating 100 V AC	Operating humidity range 40 to 80%	Storage humidity 40 to 70% (NOTE 2)

Item	Specification	Conditions
1. Insulation resistance	1000MΩ min.	100 V DC
2. Withstanding voltage	No flashover or insulation breakdown.	500 V AC / 1 minute
3. Contact resistance	40 mΩ max.	100 mA
4. Vibration	No electrical discontinuity of 10 μs or more	Frequency: 10 to 55 Hz, single amplitude of 0.75 mm, 2 hours in each of the 3 directions.
5. Humidity (Steady state)	Contact resistance 60 mΩ max. Insulation resistance 100 MΩ min.	96 hours at temperature of 40°C and humidity of 90% to 95%
6. Temperature cycle	Contact resistance 60 mΩ max. Insulation resistance 100 MΩ min.	Temperature: -55°C: 30 min. --> 15 to 35°C: 5 min. MAX --> 85°C: 30 min --> 15 to 35°C: 5 min. MAX) for 5 cycles
7. Durability (Insertion/withdrawal)	Contact resistance of 60 mΩ max.	5000 cycles
8. Resistance to Soldering heat	No deformation of components affecting performance.	Reflow: At the recommended temperature profile
		Manual soldering: 300°C for 3 seconds

Note 1: Includes temperature rise caused by current flow.

Note 2: The term "storage" refers to products stored for long period of time prior to mounting and use. Operating Temperature Range and Humidity range covers non- conducting condition of installed connectors in storage, shipment or during transportation.

■Materials

Part	Material	Finish	Remarks
Insulator	Synthetic resin	Color : Black	UL94V-0
Contacts	Phosphor bronze	Contact portion: Gold plating Lead portion: Solder plating	—
Card holder	Synthetic resin	Color : Black	UL94V-0
Slider	Synthetic resin	Color : Beige	UL94V-0

●Ordering Information

ID1A - 6 S - 2.54 SF (21)

① ② ③ ④ ⑤ ⑥

① Series Name: ID1A
② Number of contacts: 6
③ Contact type S: Socket
④ Contact pitch: 2.54 mm
⑤ Terminal type SF: SMT type
⑥ Packaging type Blank: Tray packaging (21): Embossed tape packaging

■Sockets

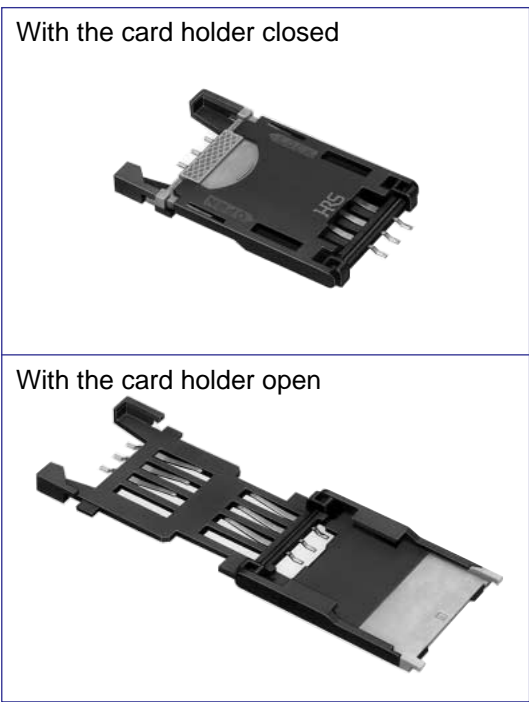
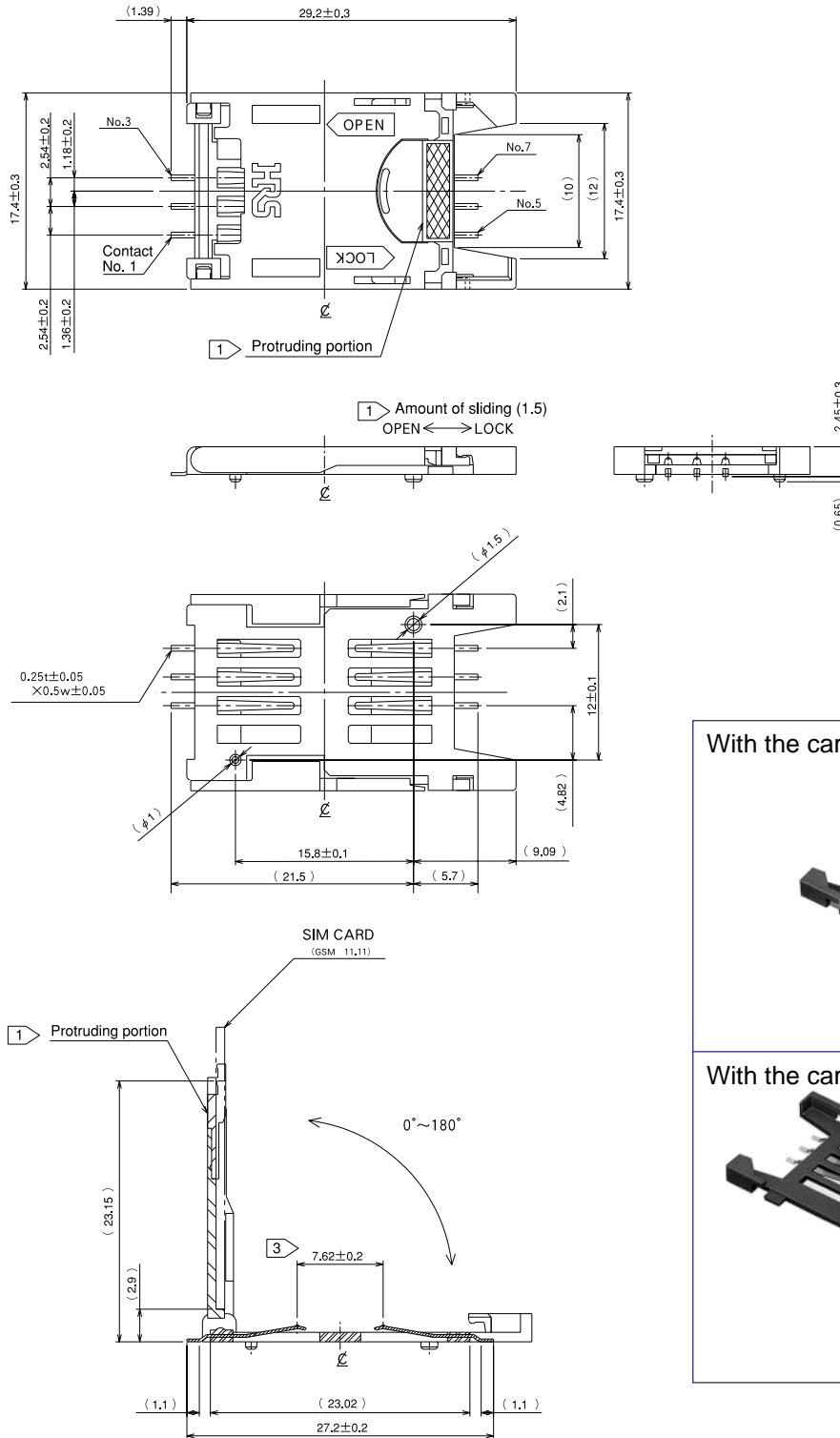

- ① When locking, slide the protruding portion of the slider after the card holder has been closed.
- ② The co-planarity at the SMT lead tip portion is 0.1 maximum.
- ③ ⌀ indicates a 7.62 ±0.2 center line.

Part Number	CL No.	Number of Contacts	Packaging type	Number of Pieces
ID1A-6S-2.54SF	645-0003-9	6	Tray	———
ID1A-6S-2.54SF(21)	645-0003-9-21	6	Embossed tape (NOTE 1)	500 pieces per reel

NOTE 1: Embossed tape packaged items are sold by the reel with 500 pieces per reel.

◆PCB mounting pattern

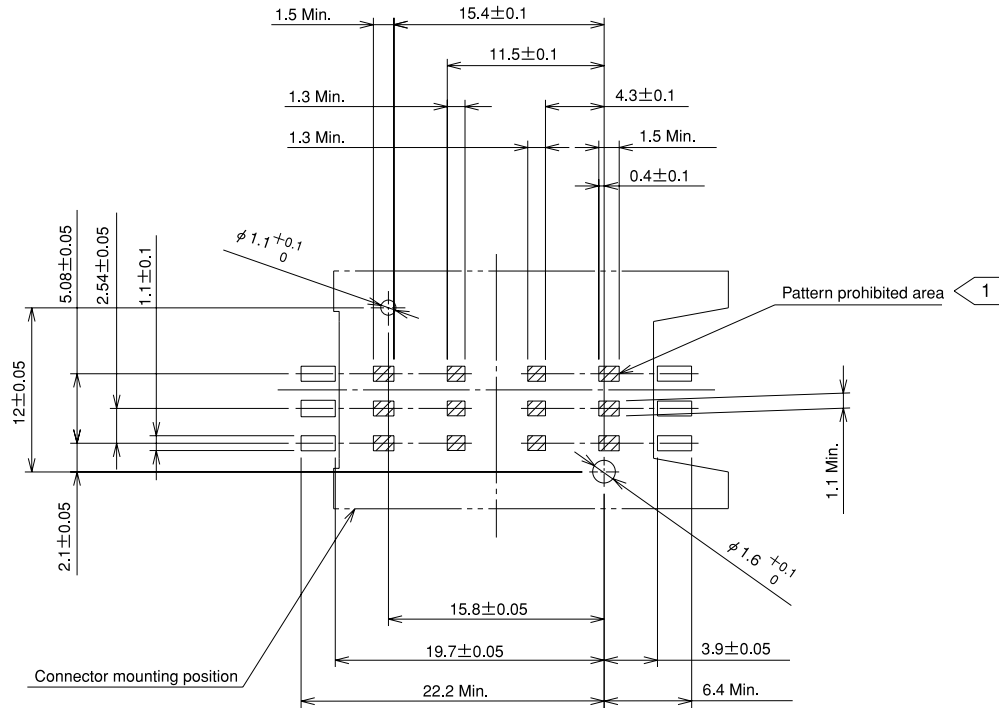

1 Shaded portions [///] indicate pattern prohibited areas.

◆Temperature Profile

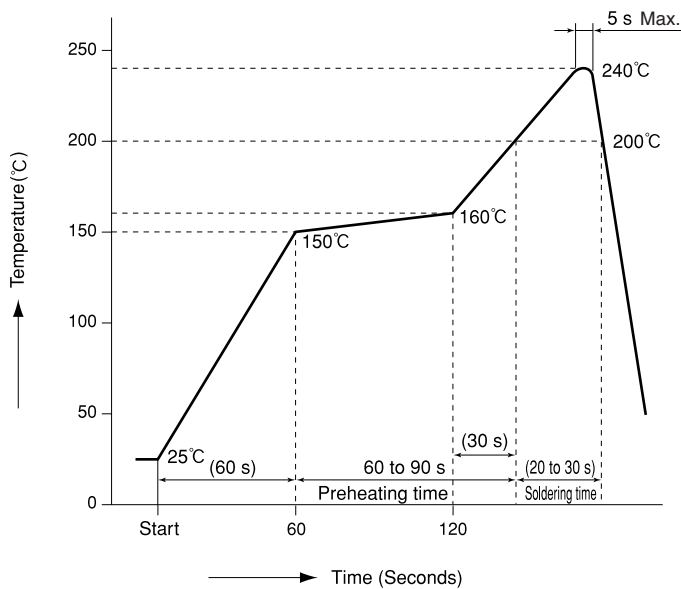

Applicable Conditions
 Reflow system: IR reflow
 Solder type: Cream type 63 Sn/37 Pb
 (Flux component 9 wt%)
 Test board: Glass epoxy 85 x 60 x 1 mm
 Metal mask thickness: 0.15 mm

Conditions may change and are dependent on type and thickness of solder.

■ Embossed Carrier Tape Dimensions

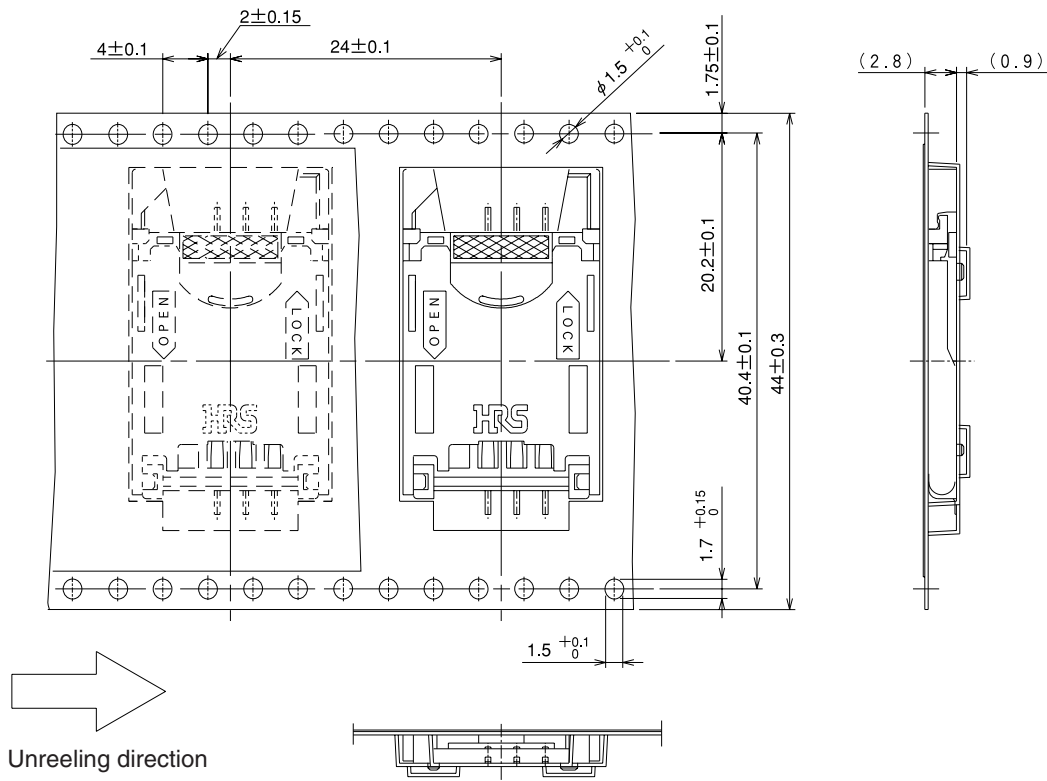

● Reel Dimensions

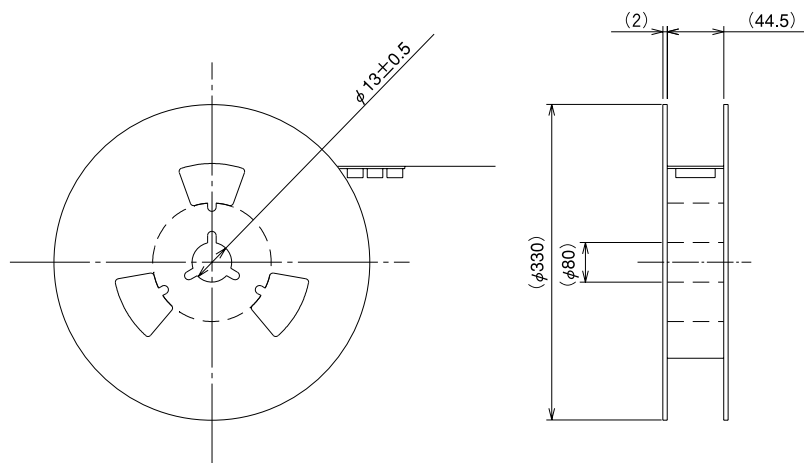

■Method of Using the Sockets

1. Part Structure and Names

Please see Photograph (3) on C39 page.

2. Opening the Holder Cover

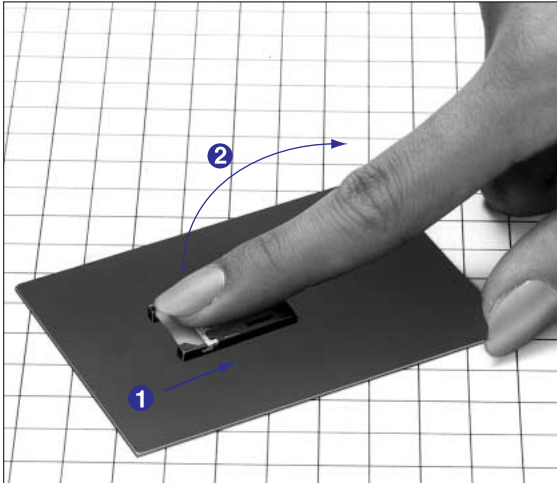

Press the slider and at the same time move it in the direction marked "OPEN". This action will release the lock and free the card holder.

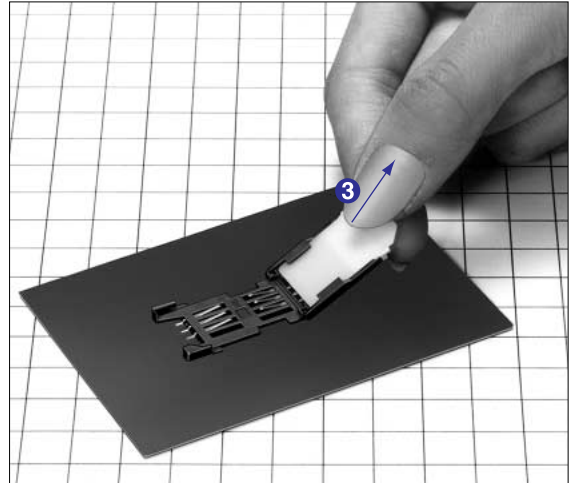

Remove the SIM card (as shown) so that it comes out from the card holder.

3. Closing the Holder Cover

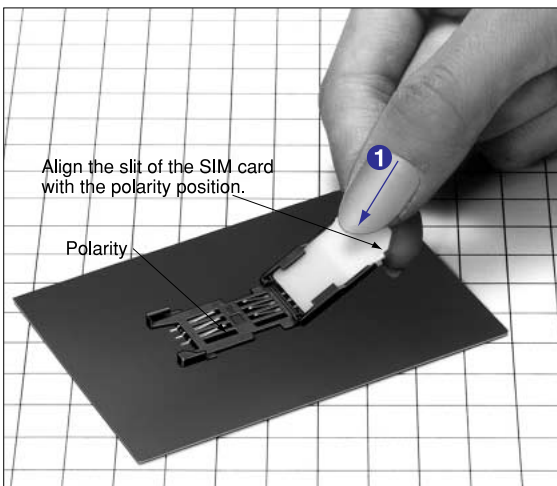

Insert the SIM card to the card holder.

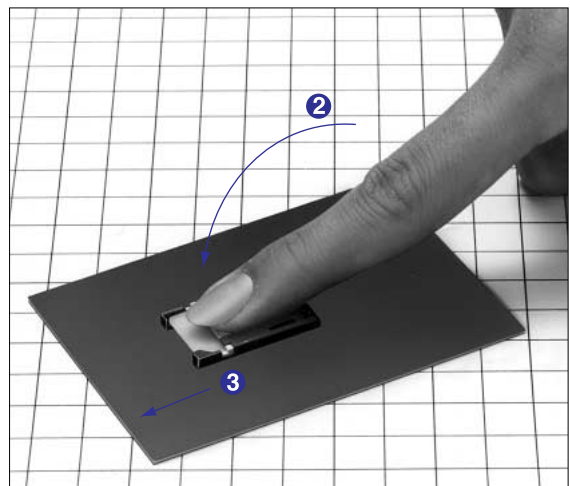

Close the card holder, press the slider, and at the same time move it in the direction marked "LOCK" on the card holder. A click sound will indicate that the lock has been engaged.

◆Precautions for Use

- 1) When opening the card holder with a SIM card inserted, avoid the action of directly lifting the SIM card and releasing the lock. Doing so will cause damage to the lock structure.
- 2) The card holder is based on a structure that moves only in the turning direction. Avoid pulling or applying unreasonable force in other directions.
- 3) Do not close the card holder when the slider is protruding from the card holder. Doing so will cause damage to the lock structure. (Please refer to the photographs below.)
- 4) A lock that is not fully engaged will cause poor contact.
- 5) Do not perform hot-line insertions. (NOTE 1)
NOTE 1: The term hot-line insertion means performing an insertion while the electricity is supplied.

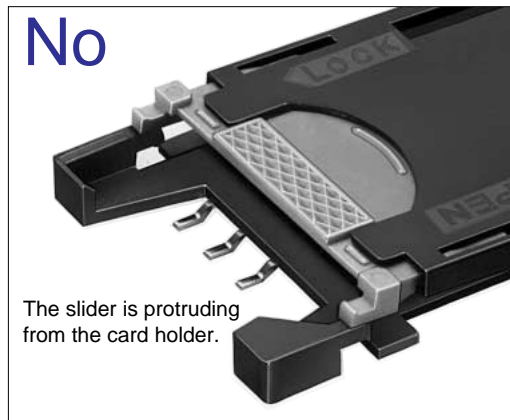
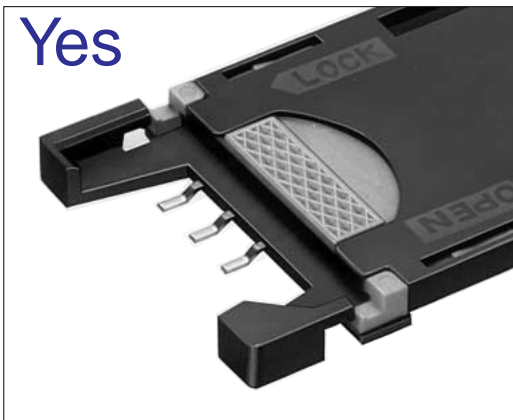

◆Washing Conditions

1) Organic Solvent Washing

Solvent	Normal temperature washing	Heated washing
IPA (Isopropyl alcohol)	Yes	Yes
HCFC (Hydrochlorofluorocarbon)	Yes	Yes

2) Water Type Washing

When using water type cleaning agents (e.g., terpene, and alkali saponifiers), select the cleaning agent based on the documentation issued by the various manufacturers of cleaning agents which describes the effects on metals and resins.

3) Washing Precautions







Residual flux or cleaning agent on the sockets when washing with organic solvents or water type cleaners can give rise to the deterioration of electrical performance. In this regard it is important to check whether a thorough washing has been performed.

Looking for pricing, stock, or lifecycle information?

Click below to explore more details on WIN SOURCE:

-  [View ID1A-6S-2.54SFB\(81\) on WIN SOURCE](#)
-  [Hirose Electric Co Ltd Information](#)

Optimize Your Supply Chain with WIN SOURCE Solutions

-  Global Sourcing Solution
-  Obsolete Management
-  Cost Control Management
-  Shortage Management
-  Alternative Solution
-  Excess Inventory Management