



**THE DATASHEET OF
HRF-AT4610-FL-TR**



HRF-AT4610

31.5 dB, DC - 4GHz, 6 Bit Parallel Digital Attenuator

The Honeywell HRF-AT4610 is a 6-bit digital attenuator ideal for use in broadband communication system applications that require accuracy, speed and low power consumption. The HRF-AT4610 is manufactured with Honeywell's patented Silicon On Insulator (SOI) CMOS manufacturing technology, which provides the performance of GaAs with the economy and integration capabilities of conventional CMOS. These attenuators are DC coupled to improve lower operating frequency, frequency response and reduce the number of DC bias points required.

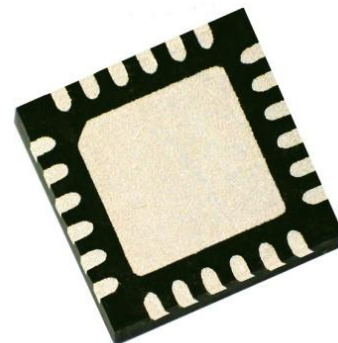

HRF-AT4610 in VQFN Package

FEATURES

- Very Low DC Power Consumption
- Attenuation In Steps From 0.5 dB To 31.5 dB
- Single Positive Power Supply Voltage
- Parallel Data Interface
- 50 Ohm Impedance
- DC-coupled, bi-directional RF path
- Space Saving VQFN Surface Mount Packaging
- Lead-free, RoHS compliant and halogen-free

RF ELECTRICAL SPECIFICATIONS @ + 25°C

Results @ $V_{DD} = 5.0 \pm 10\%$, $V_{SS} = 0$ unless otherwise stated, $Z_0 = 50$ Ohms
Contact Honeywell for relative performance at other supply configurations

Parameter	Test Condition	Frequency	Minimum	Typical	Maximum	Units
Insertion Loss		1.0 GHz		2.5	2.9	dB
		2.5 GHz		3.0	3.5	dB
		3.0 GHz		3.6	3.9	dB
		4.0 GHz		5.5	5.8	dB
1dB Compression	$V_{SS} = 0V$, Input Power	2.0 GHz		24		dBm
	$V_{SS} = -3V$, Input Power	2.0 GHz		29		dBm
Input IP3	$V_{SS} = 0V$ Two-tone inputs, up to +5 dBm @ 0 dBm attenuation	2.0 GHz		38		dBm
Input IP3	$V_{SS} = -3V$ Two-tone inputs, up to +5 dBm @ 0 dBm attenuation	2.0 GHz		>38		dBm
Return Loss	Any Bit or Combination		-11	-13		dB
Attenuation Accuracy	All attenuation states	1.0 GHz	+/- (0.3 + 3.0% of programmed IL)			dB
		2.5 GHz	+/- (0.3 + 4.0% of programmed IL)			dB
		3.0 GHz	+/- (0.3 + 5.5% of programmed IL)			dB
		4.0 GHz	+/- (0.3 + 7.0 % of programmed IL)			dB
Trise, Tfall Ton, Toff (Tpd)	10% To 90%			10		nS
	50% Cntl To 90% / 10%RF			15		nS
T clock Period (Tprd)	T high / T low = 1/2 minimum clock period		50			nS
T data set up (Tsup)	Set up to rising edge of clock		5			nS
T data hold (Thld)	Data hold after rising edge of clock		2			nS
T latch set up (Tlsup)	Data set up to rising edge of OE		5			nS

HRF-AT4610

FUNCTIONAL SCHEMATIC

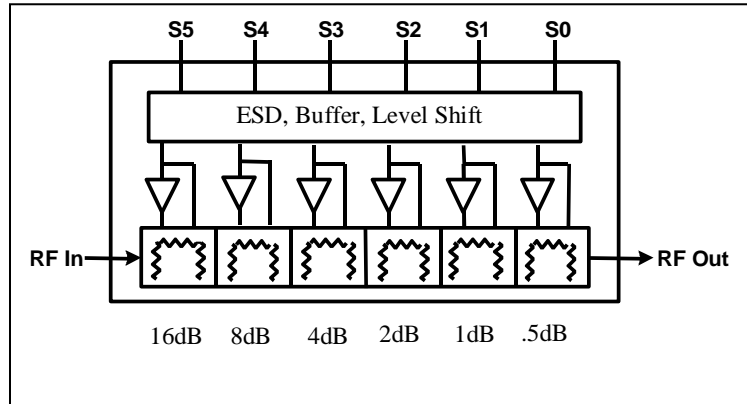

DC ELECTRICAL SPECIFICATIONS @ + 25°C

Parameter	Minimum	Typical	Maximum	Units
V_{DD}	3.3 ¹	5.0	5.5	V
V_{SS}	-5.0			V
I_{DD}		<5.0	50	uA
CMOS Logic level (0)	0		0.8	V
CMOS Logic level (1)	$V_{DD} - 0.8$		V_{DD}	V
Input Leakage Current			10	uA

Note 1, the performance curves are for $V_{DD} = +5.0 \pm 10\%$

ABSOLUTE MAXIMUM RATINGS¹

Parameter	Absolute Maximum	Units
Input Power	+ 35	dBm
V_{DD}	+6.0	V
V_{SS}	-5.5	V
ESD Voltage ²	400	V
Operating Temperature	-40 To +85	°C
Storage Temperature	-65 To +125	°C
Moisture Sensitivity Level	Level 3 @ 260°C	
Digital Inputs	$V_{DD} + 0.6$ max to -0.6 min	V

Note 1 - Operation of this device beyond any of these parameters may cause permanent damage.

Note 2 - Although the HRF-AT4610 contains ESD protection circuitry on all digital inputs, precautions should be taken to ensure that the Absolute Maximum Ratings are not exceeded.

Latch-Up: Unlike conventional CMOS digital attenuators, Honeywell's HRF-AT4610 is immune to latch-up.

HRF- AT4610

PIN CONFIGURATIONS

Pin	Function	Pin	Function
1	VDD	13	GROUND
2	GROUND	14	GROUND
3	GROUND	15	RF OUTPUT
4	RF INPUT	16	GROUND
5	GROUND	17	VSS
6	GROUND	18	GROUND
7	GROUND	19	S0
8	GROUND	20	S1
9	GROUND	21	S2
10	GROUND	22	S3
11	GROUND	23	S4
12	GROUND	24	S5

Note: Bottom ground plate must be grounded for proper RF performance.

TRUTH TABLE

S5	S4	S3	S2	S1	S0
0	0	0	0	0	0
0	0	0	0	0	1
0	0	0	0	1	0
0	0	0	1	0	0
0	0	1	0	0	0
0	1	0	0	0	0
1	0	0	0	0	0
1	1	1	1	1	1

Operation: Data on parallel input "S" pins are independently buffered and presented to the RF attenuator circuits.
"0" = CMOS Low, "1" = CMOS High.

HRF-AT4610

PERFORMANCE CURVES

Insertion Loss

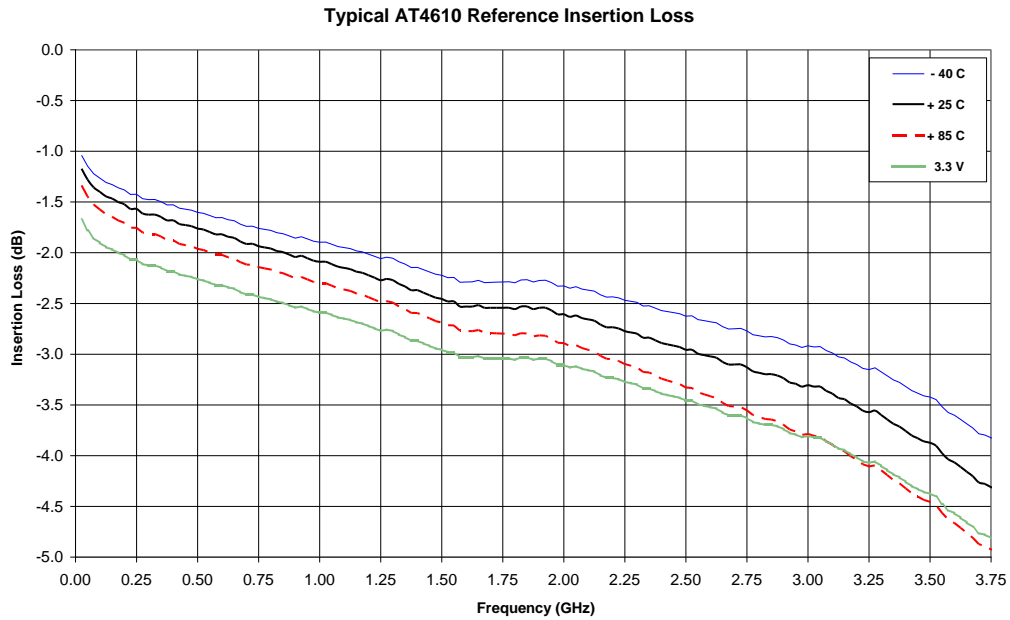

Return Loss

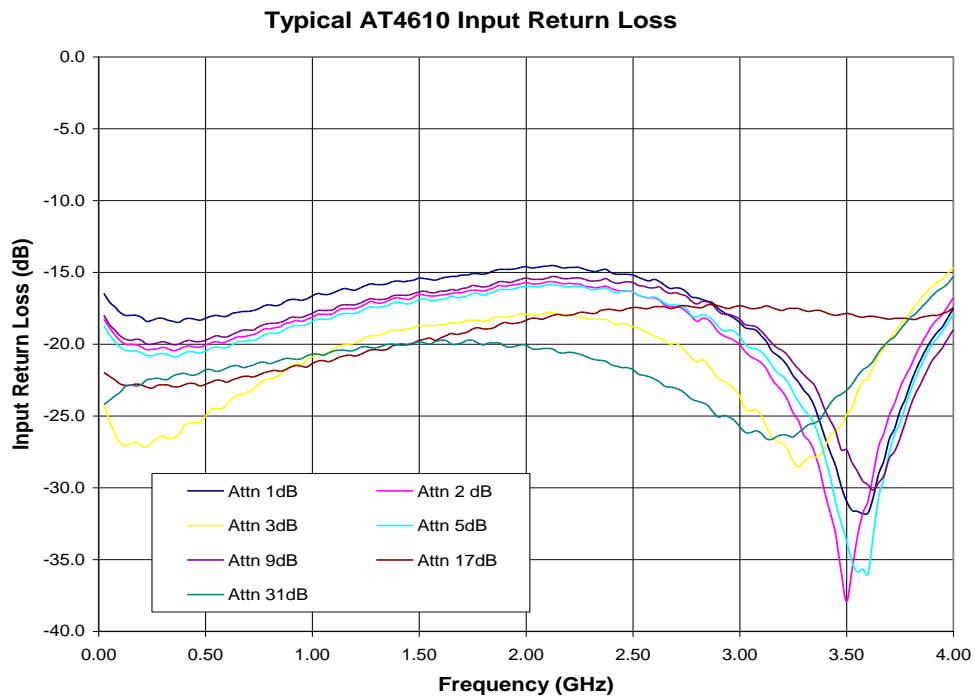

HRF- AT4610

Step Accuracy

Typical AT4610 Step Accuracy

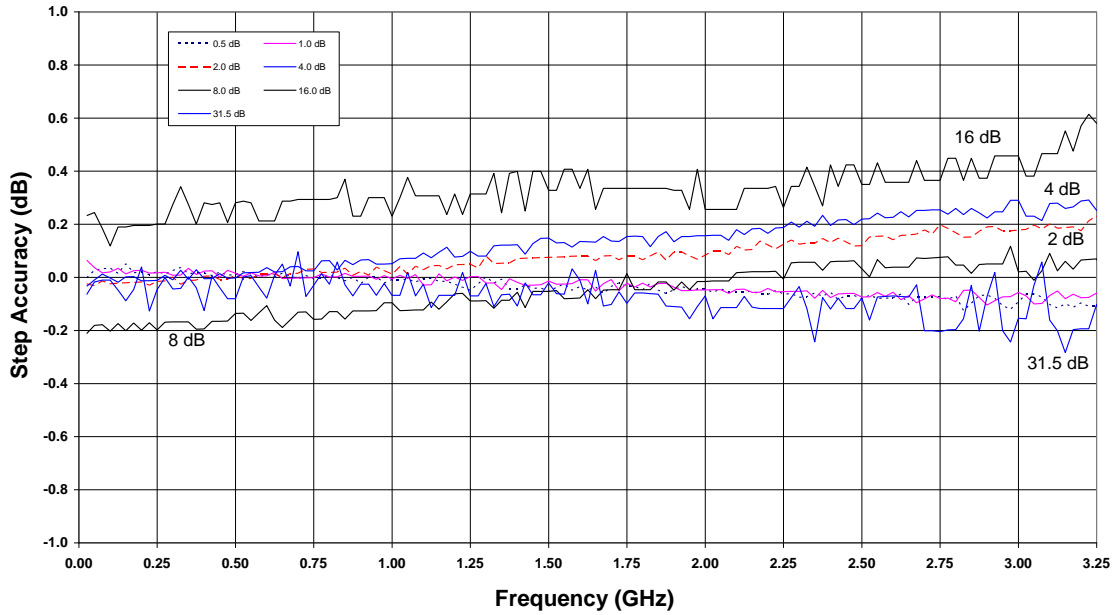

Relative Accuracy

Typical AT4610 Relative Accuracy

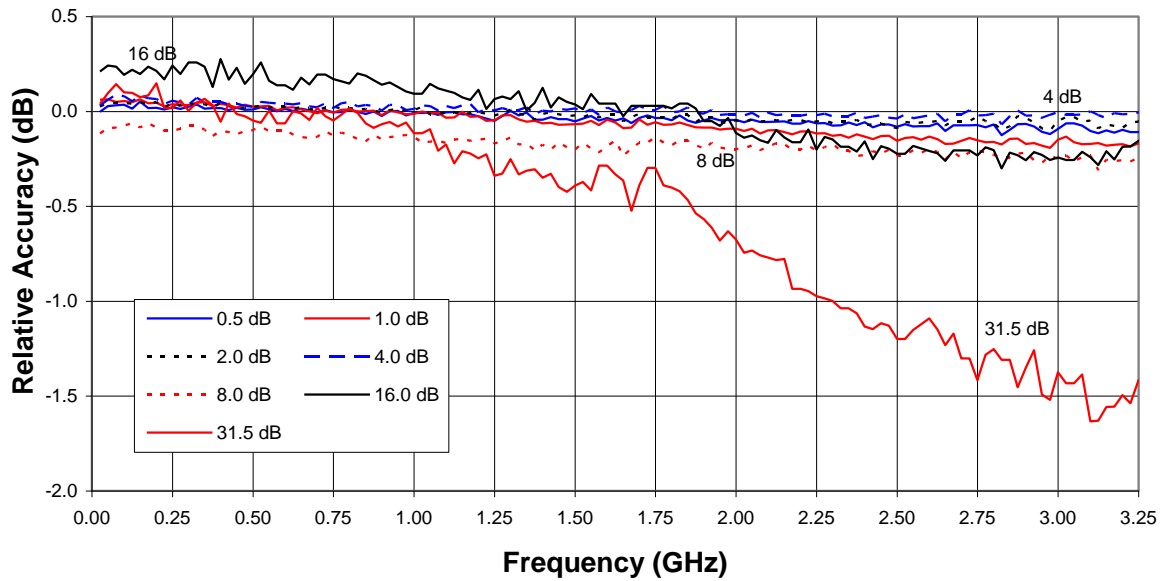

HRF-AT4610

PACKAGE OUTLINE DRAWING

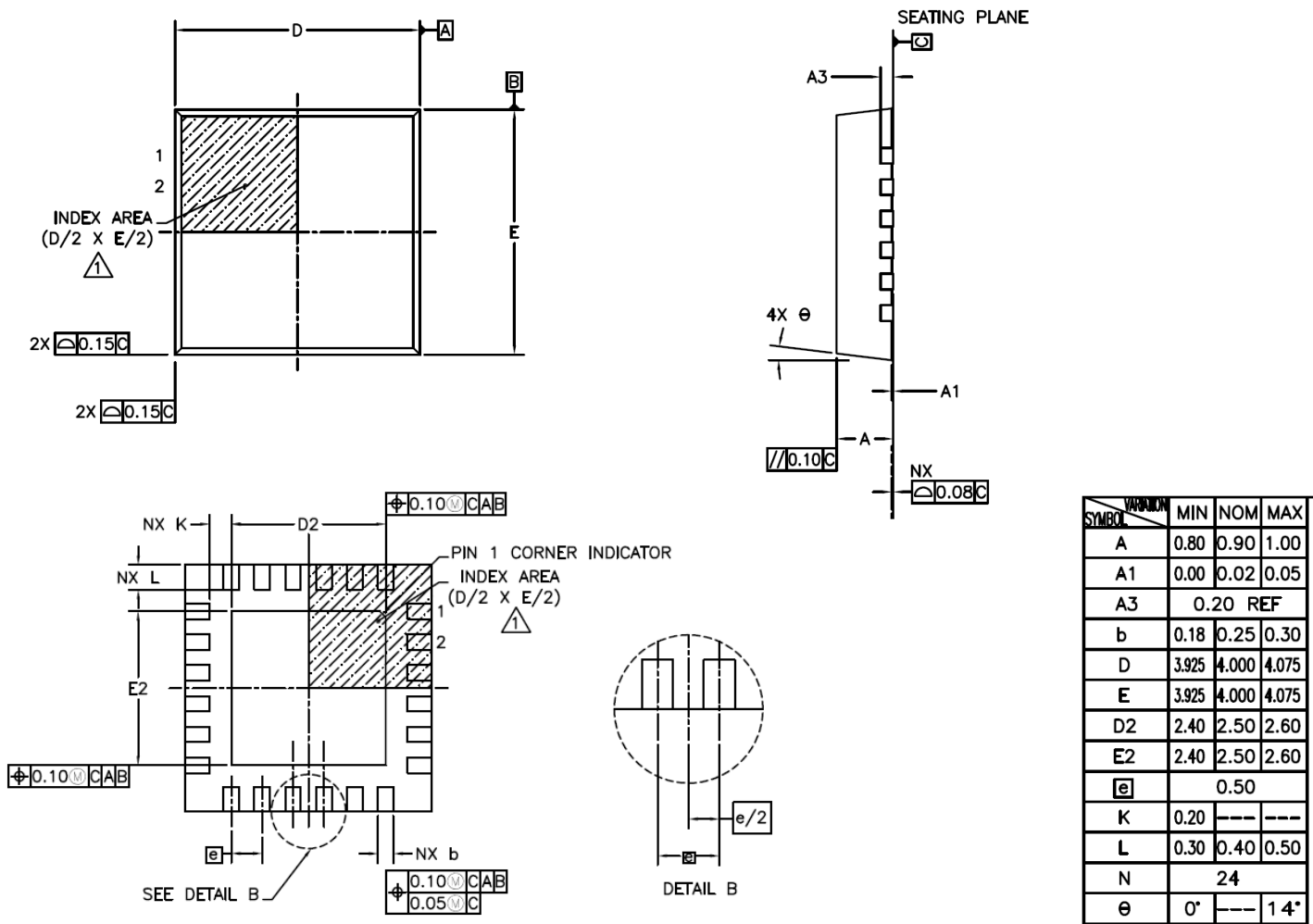

Notes

1. Pin 1 identifier can be a combination or a dot and/or chamfer. A chamfer is on the bottom ground plane.
2. Dimensions are in millimeters.

HALOGEN-FREE MATERIAL SET

The -FL attenuators have a Halogen-free material set that can withstand a maximum soldering temperature of 260°C.

LEAD FINISH

The package leads are Nickel Palladium Gold with Silver flash (NiPdAu+Ag). The configuration being manufactured and delivered today is lead-free and RoHS compliant. Plating thicknesses are listed below in microns (um).

Ni = 0.254 um min	Pd = 0.00254 um min	Au+Ag = 0.00508 um min	Au Composition = 30% min to 70% max
-------------------	---------------------	------------------------	-------------------------------------

LEAD FREE QFN SURFACE MOUNT APPLICATION

Please see Application Note AN310 for assembly process recommendations. The maximum soldering temperature of the -FL is 260°C. Application Notes can be found at our website: www.honeywell.com/microwave

CIRCUIT APPLICATION INFORMATION

These attenuators require a DC reference to ground. They may not operate properly when AC coupled on both the RF input and output without a DC ground reference provided as part of the circuit. See Application Note AN311.

HRF- AT4610

EVALUATION CIRCUIT BOARD

Honeywell's evaluation board provides an easy to use method of evaluating the RF performance of our attenuator. Simply connect power, DC and RF signals to be measuring attenuator performance in less than 10 minutes.

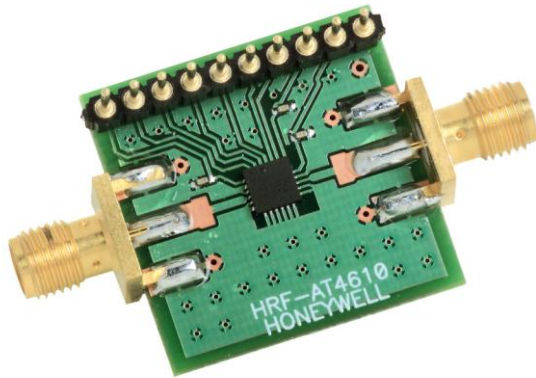

HRF-AT4610 Evaluation Board

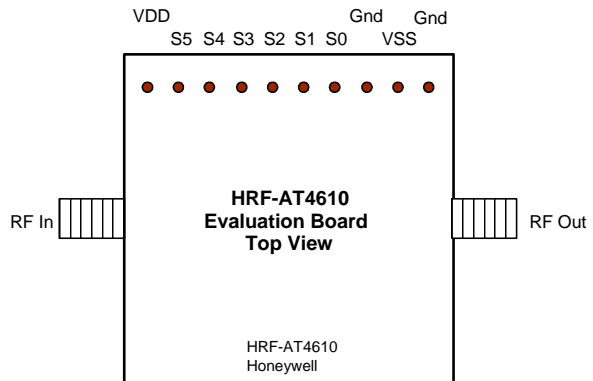

EVALUATION CIRCUIT BOARD LAYOUT DESIGN DETAILS

Item	Description
PCB	Impedance Matched Multi-Layer FR4
Attenuator	HRF-AT4610 Digital Attenuator
Chip Capacitor	Panasonic Model ECU-E1C103KBQ Capacitor, .01uf 0402 10% 16V
RF Connector	Johnson Connectors Model 142-0701-801 SMA RF Coaxial Connector
DC Pin	Mil-Max Model 800-10-064-10-001 Header Pins

ORDERING INFORMATION

Ordering Number	Delivery Method	Units Per Shipment
HRF-AT4610-FL-TR HRF-AT4610-E	Tape & Reel Evaluation Board	2500 Units per Reel One Board Per Box

The new –FL attenuators replace and are electrically equivalent to the –GR attenuators. The –GR attenuators are obsolete.

FIND OUT MORE

For more information on Honeywell's Microwave Products visit us online at www.honeywellmicrowave.com or contact us at 800-323-8295 (763-954-2474 internationally).

Honeywell reserves the right to make changes to improve reliability, function or design. Honeywell does not assume any liability arising out of the application or use of any product or circuit described herein; neither does it convey any license under its patent rights nor the rights of others.

Looking for pricing, stock, or lifecycle information?

Click below to explore more details on WIN SOURCE:

 [View HRF-AT4610-FL-TR on WIN SOURCE](#)

 [Honeywell Information](#)

Optimize Your Supply Chain with WIN SOURCE Solutions

-  Global Sourcing Solution
-  Obsolete Management
-  Cost Control Management
-  Shortage Management
-  Alternative Solution
-  Excess Inventory Management