



# THE DATASHEET OF HMC798LC4





## GaAs MMIC SUB-HARMONIC SMT MIXER, 24 - 34 GHz

### Typical Applications

The HMC798LC4 is ideal for:

- Point-to-Point Radios
- Point-to-Multi-Point Radios & VSAT
- Test Equipment & Sensors
- Military End-Use
- SATCOM

### Features

- Integrated LO Amplifier: +4 dBm Input
- Sub-Harmonically Pumped (x2) LO
- Wideband IF: DC - 4 GHz
- Single Positive Supply: +5V @ 95mA
- 24 Lead 4x4mm SMT Package: 16mm<sup>2</sup>

### Functional Diagram

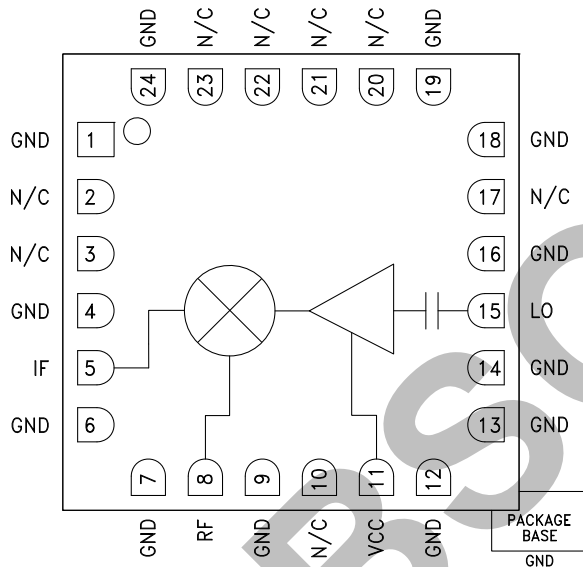

### General Description

The HMC798LC4 is a 24 - 34 GHz Sub-harmonically Pumped (x2) MMIC Mixer with an integrated LO amplifier in a leadless RoHS compliant SMT package. The 2LO to RF isolation is excellent at 30 dB, eliminating the need for additional filtering. The LO amplifier is a single bias +5V design with a nominal +4 dBm drive requirement. The RF and LO ports are matched to 50 Ohms for ease of use while the IF covers DC to 4 GHz. The HMC798LC4 eliminates the need for wire bonding, allowing use of surface mount manufacturing techniques.

### Electrical Specifications, $T_A = +25^\circ\text{C}$ , $V_{CC} = 5\text{V}$

Parameter	IF = 1 GHz LO = 4 dBm			IF = 1 GHz LO = 4 dBm			Units
	Min.	Typ.	Max.	Min.	Typ.	Max.	
Frequency Range, RF	24 - 29.5			29.5 - 34			GHz
Frequency Range, LO	12 - 16			13.5 - 17.75			GHz
Frequency Range, IF	DC - 4			DC - 4			GHz
Conversion Loss		11	13		10	12	dB
2LO to RF Isolation	25	30		20	25		dB
2LO to IF Isolation		45			35		dB
IP3 (Input)	17	20		19	22		dBm
1 dB Compression (Input)		10			12		dBm
Supply Current (I <sub>dd</sub> )		95	125		95	125	mA

\*Unless otherwise noted, all measurements performed as upconverter, IF= 1 GHz, LO = 4 dBm



**GaAs MMIC SUB-HARMONIC  
SMT MIXER, 24 - 34 GHz**

**Conversion Gain vs. Temperature, LSB**

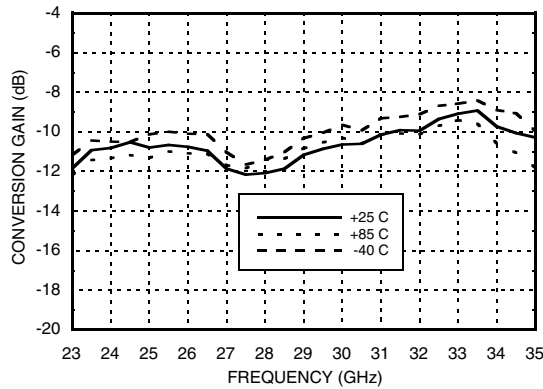

**Conversion Gain vs. Temperature, USB**

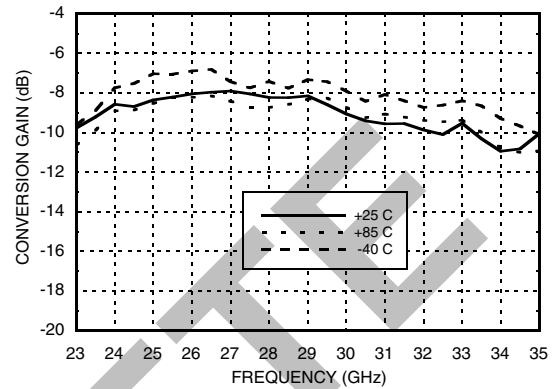

**Conversion Gain vs. LO Drive, LSB**

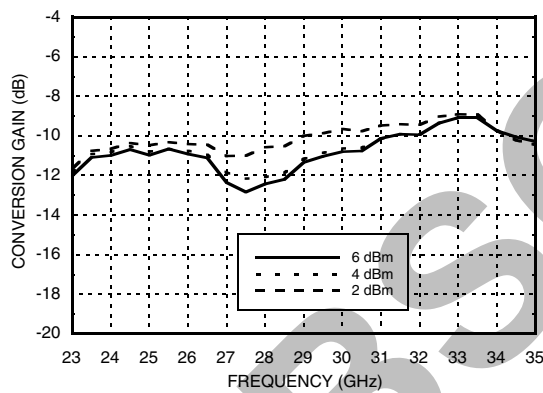

**Isolations**

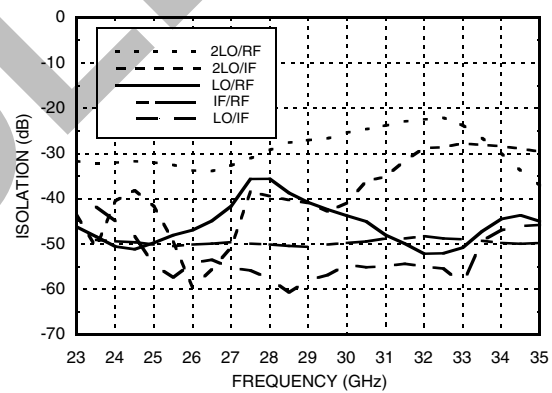

**Input IP3 vs. LO Drive**

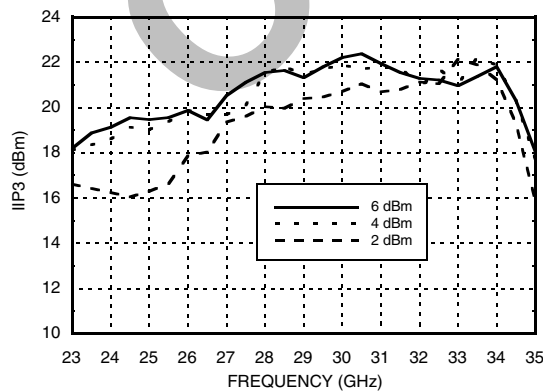

**Input IP3 vs. Temperature**

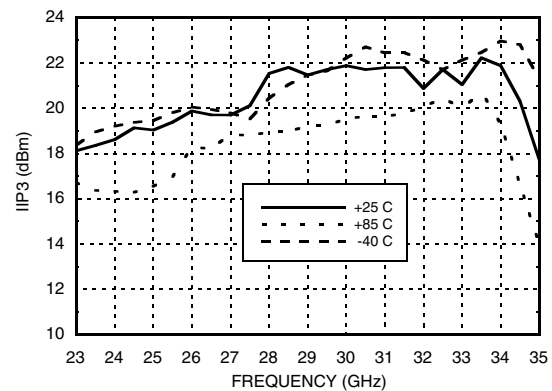

Information furnished by Analog Devices is believed to be accurate and reliable. However, no responsibility is assumed by Analog Devices for its use, nor for any infringements of patents or other rights of third parties that may result from its use. Specifications subject to change without notice. No license is granted by implication or otherwise under any patent or patent rights of Analog Devices. Trademarks and registered trademarks are the property of their respective owners.

For price, delivery, and to place orders: Analog Devices, Inc., One Technology Way, P.O. Box 9106, Norwood, MA 02062-9106 Phone: 781-329-4700 • Order online at [www.analog.com](http://www.analog.com) Application Support: Phone: 1-800-ANALOG-D



**GaAs MMIC SUB-HARMONIC SMT MIXER, 24 - 34 GHz**

**Input IP2 vs. LO Drive**

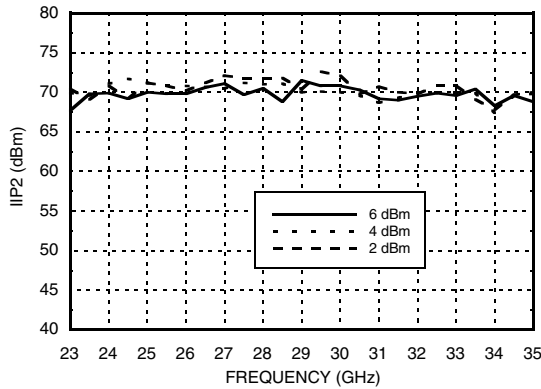

**Input IP2 vs. Temperature**

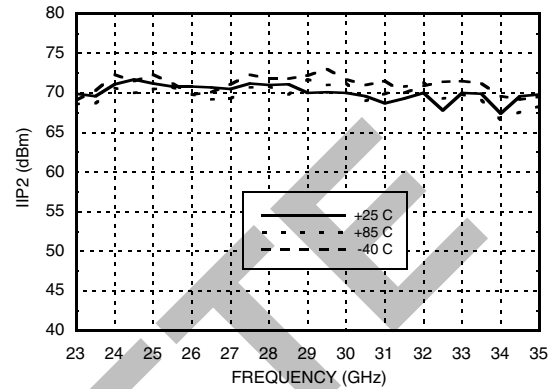

**Input P1dB vs. Temperature, LSB**

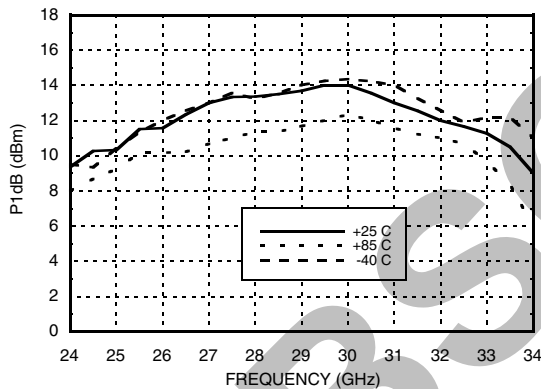

**Input P1dB vs. Temperature, USB**

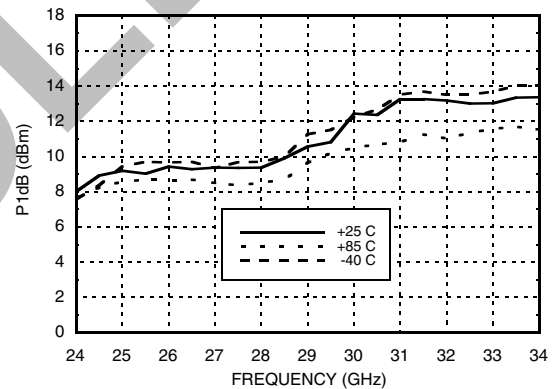

**Conversion Gain vs. IF Frequency, LSB**

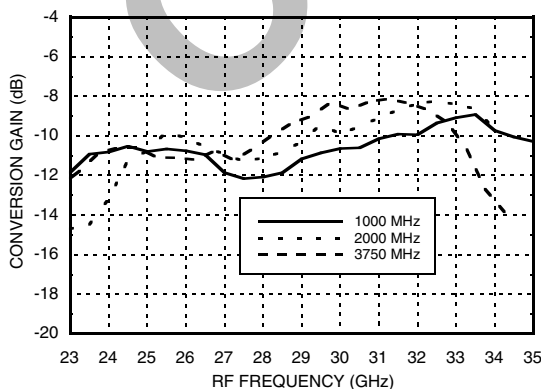

**Conversion Gain vs. IF Frequency, USB**

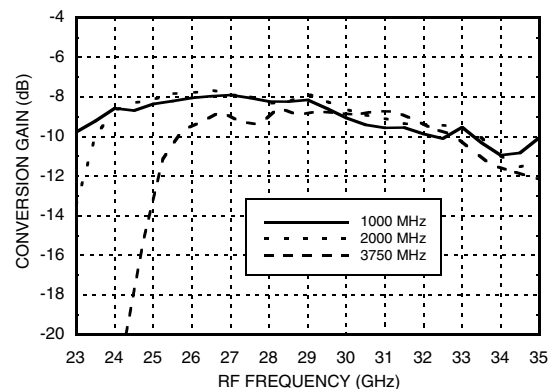

\* Two-tone input power = 0 dBm each tone, 1 MHz spacing.



**GaAs MMIC SUB-HARMONIC SMT MIXER, 24 - 34 GHz**

**IF Return Loss**

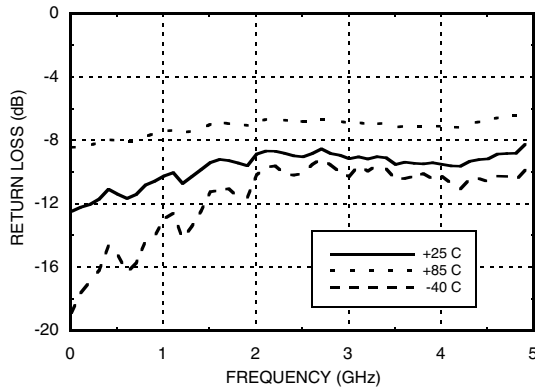

**RF Return Loss**

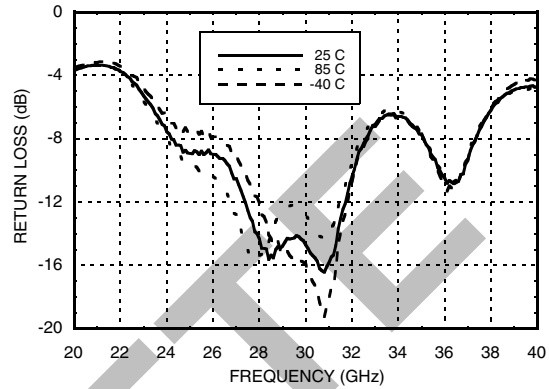

**LO Return Loss**

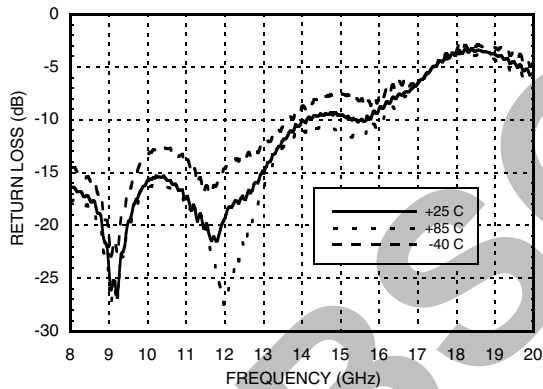

**MxN Spurious Outputs @ RF Port, Vdd = 5V**

mIF	nLO		
	2	1	0
-3	68		
-2	53	71	66
-1	0	49	32
0	1	31	
1	1	45	31
2	54	66	65
3	66		

IF = 2 GHz @ -10 dBm  
 LO = 15 GHz @ 4 dBm  
 All values in dBc below IF power level (2LO - 1IF)  
 Measured as upconverter



## GaAs MMIC SUB-HARMONIC SMT MIXER, 24 - 34 GHz

### Absolute Maximum Ratings

RF / IF Input (Vdd = +5V)	+13 dBm
LO Drive (Vdd = +5V)	+10 dBm
Vdd	5.5V
Channel Temperature	175 °C
Continuous P <sub>diss</sub> (Ta = 85 °C) (derate 8.33 mW/°C above 85 °C)	0.75 mW
Thermal Resistance (junction to ground paddle)	119 °C/W
Storage Temperature	-65 to +150 °C
Operating Temperature	-40 to +85 °C



ELECTROSTATIC SENSITIVE DEVICE  
OBSERVE HANDLING PRECAUTIONS

### Outline Drawing

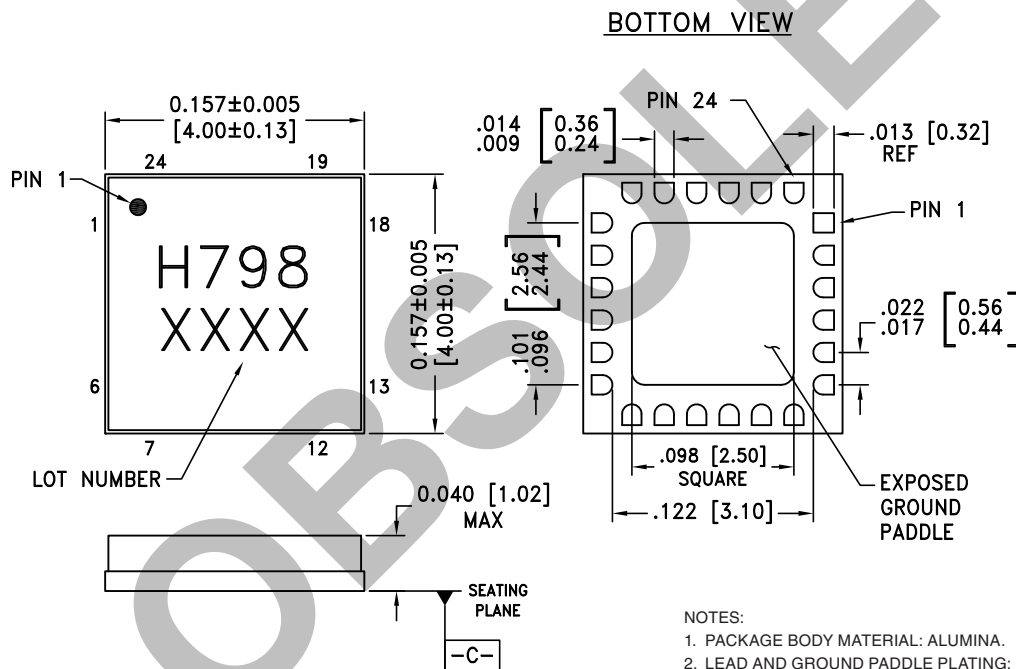

NOTES:

1. PACKAGE BODY MATERIAL: ALUMINA.
2. LEAD AND GROUND PADDLE PLATING: GOLD FLASH OVER NICKEL.
3. DIMENSIONS ARE IN INCHES (MILLIMETERS).
4. LEAD SPACING TOLERANCE IS NON-CUMULATIVE.
5. CHARACTERS TO BE HELVETICA MEDIUM, .025 HIGH, BLACK INK, OR LASER MARK LOCATED APPROX. AS SHOWN.
6. PACKAGE WARP SHALL NOT EXCEED 0.05MM DATUM  $\square-C$
7. ALL GROUND LEADS AND GROUND PADDLE MUST BE SOLDERED TO PCB RF GROUND.



### Package Information

Part Number	Package Body Material	Lead Finish	MSL Rating	Package Marking <sup>[2]</sup>
HMC798LC4	Alumina, White	Gold over Nickel	MSL3 <sup>[1]</sup>	H798 XXXX

[1] Max peak reflow temperature of 260 °C

[2] 4-Digit lot number XXXX

**GaAs MMIC SUB-HARMONIC  
SMT MIXER, 24 - 34 GHz**
**Pin Descriptions**

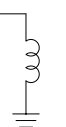
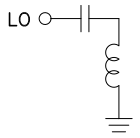
Pin Number	Function	Description	Interface Schematic
1, 4, 6, 7, 9, 12 - 14, 16, 18, 19, 24	GND	These pins and package bottom must be connected to RF/DC ground.	
2, 3, 10, 17, 20 - 23	N/C	No connection required. The pins are not connected internally; however, all data shown herein was measured with these pins connected to RF/DC ground externally.	
5	IF	This pin is DC coupled and should be DC blocked externally using a series capacitor whose value has been chosen to pass the necessary IF frequency range. Any applied DC voltage to this pin will result in die non-function and possible die failure.	
8	RF	This pin is DC coupled and matched to 50 Ohms.	
11	Vcc	Power supply for the LO Amplifier.	
15	LO	This pin is DC blocked and matched to 50 Ohms.	

OBSOLETE



**GaAs MMIC SUB-HARMONIC SMT MIXER, 24 - 34 GHz**

**Evaluation PCB**

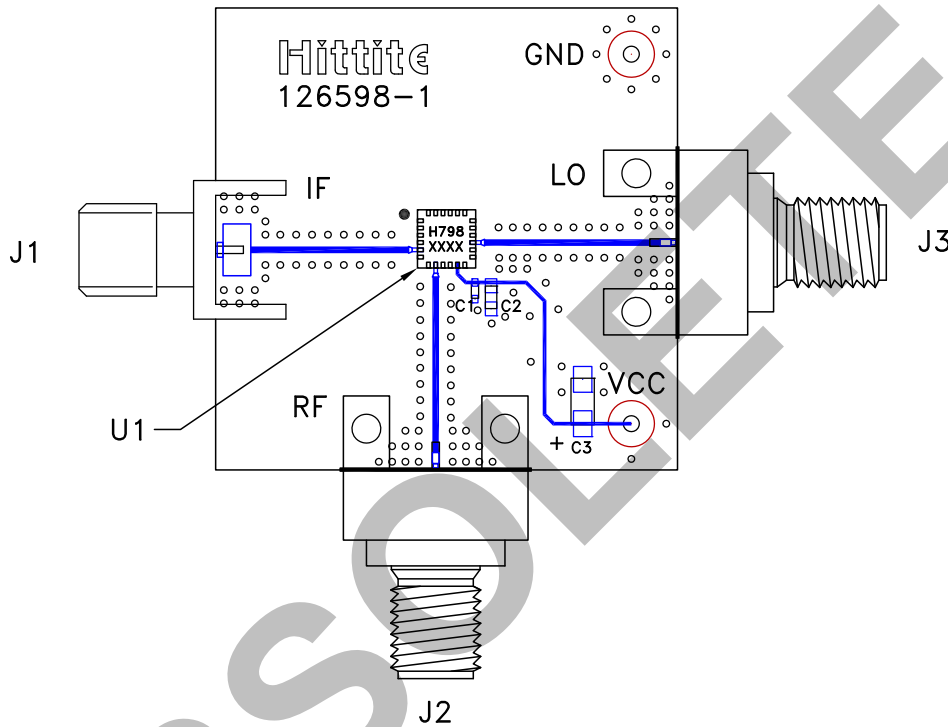

**List of Materials for Evaluation PCB 126601 [1]**

Item	Description
J1 - J3	PCB Mount SMA RF Connector
J2, J3	PCB Mount SRI K Connector
J4, J5	DC Pin
C1	100 pF Capacitor, 0402 Pkg.
C2	10,000 pF Capacitor, 0603 Pkg.
C3	4.7 µF Tantalum Capacitor, Case A
U1	HMC798LC4 Mixer
PCB [2]	126598 Evaluation PCB

[1] Reference this number when ordering complete evaluation PCB

[2] Circuit Board Material: Arlon 25FR or Rogers 4350

The circuit board used in this application should use RF circuit design techniques. Signal lines should have 50 Ohm impedance while the package ground leads and exposed paddle should be connected directly to the ground plane similar to that shown. A sufficient number of via holes should be used to connect the top and bottom ground planes. The evaluation board should be mounted to an appropriate heat sink. The evaluation circuit board shown is available from Hittite upon request.

**GaAs MMIC SUB-HARMONIC  
SMT MIXER, 24 - 34 GHz****Notes:**

OBSOLETE

## Looking for pricing, stock, or lifecycle information?

Click below to explore more details on WIN SOURCE:

 [View HMC798LC4 on WIN SOURCE](#)

 [Analog Devices Inc. Information](#)

## Optimize Your Supply Chain with WIN SOURCE Solutions

-  Global Sourcing Solution
-  Obsolete Management
-  Cost Control Management
-  Shortage Management
-  Alternative Solution
-  Excess Inventory Management