



**THE DATASHEET OF  
HMC546LP2E**



**FEATURES****High input P0.1dB: 40 dBm Tx****Low insertion loss: 0.4 dB****High input IP3: 67 dBm****Positive control: 0 V low control; 3 V to 8 V high control****Failsafe operation: Tx is on when no dc power is applied****APPLICATIONS****LNA protection, WiMAX, and WiBro****Cellular, PCS, 3G, and TD-SCDMA infrastructure****Private mobile radio and public safety handsets****Automotive telematics****GENERAL DESCRIPTION**

The [HMC546LP2E](#) is a failsafe SPDT switch in a leadless DFN surface-mount plastic package for use in transmit/receive and LNA protection applications that require very low distortion and high power handling of up to 10 watts.

The [HMC546LP2E](#) requires external matching and is suitable for narrow-band applications within 200 MHz to 2700 MHz.

**FUNCTIONAL BLOCK DIAGRAM**

Figure 1.

This narrow-band switch is well suited for WiMAX and WiBro repeaters, private mobile radio (PMR), and automotive telematic applications. The design provides exceptional P0.1dB of 40 dBm and IIP3 of 65 dBm on the transmit (Tx) port. The failsafe topology allows the switch to provide a low loss path from RFC to Tx, when no dc power is available.

## TABLE OF CONTENTS

|  |   |   |    |
|--|---|---|----|
| Features .....                                   | 1 | 1843 MHz Tuning .....                     | 7  |
| Applications.....                                | 1 | 2015 MHz Tuning .....                     | 8  |
| Functional Block Diagram .....                   | 1 | 2350 MHz Tuning .....                     | 9  |
| General Description .....                        | 1 | 2600 MHz Tuning .....                     | 10 |
| Revision History .....                           | 2 | Applications Information .....            | 11 |
| Specifications.....                              | 3 | Components for Selected Frequencies ..... | 11 |
| Absolute Maximum Ratings.....                    | 5 | Evaluation PCB.....                       | 12 |
| ESD Caution.....                                 | 5 | Outline Dimensions .....                  | 13 |
| Pin Configuration and Function Descriptions..... | 6 | Ordering Guide .....                      | 13 |
| Interface Schematics .....                       | 6 |   |    |
| Typical Performance Characteristics .....        | 7 |   |    |

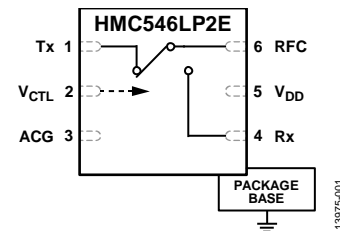
## REVISION HISTORY

This Hittite Microwave Products data sheet has been reformatted to meet the styles and standards of Analog Devices, Inc.

### 5/2016—v.04.1115 to Rev. E

|   |            |
|---|------------|
| Updated Format .....  | Universal  |
| Deleted HMC546LP2.....  | Throughout |
| Deleted Table 2, Renumbered Sequentially.....                           | 4          |
| Added Pin Function Descriptions, Table 5, Renumbered Sequentially ..... | 7          |
| Changes to Table 7.....   | 13         |
| Updated Outline Dimensions .....  | 14         |
| Changes to Ordering Guide .....   | 14         |

## SPECIFICATIONS

$T_A = 25^\circ\text{C}$ ,  $V_{DD} = 0\text{ V}/3\text{ V dc}$ ,  $V_{CTL} = 0\text{ V}/3\text{ V dc}$ ,  $50\ \Omega$  system. Specifications and data reflect measurements using the respective application circuit components for each frequency band as listed in Table 1.

Table 1.

| Parameter                   | Symbol | Test Conditions/Comments                                      | Min  | Typ  | Max  | Unit |
|-----------------------------|--------|---|------|------|------|------|
| FREQUENCY RANGE             |        |   | 200  |      | 2700 | MHz  |
| INSERTION LOSS              |        |   |      |      |      |      |
| Tx to RFC                   |        | f = 1805 MHz to 1910 MHz                                      |      | 0.3  | 0.6  | dB   |
|                             |        | f = 2010 MHz to 2025 MHz                                      |      | 0.4  | 0.7  | dB   |
|                             |        | f = 2300 MHz to 2480 MHz                                      |      | 0.6  | 0.8  | dB   |
|                             |        | f = 2500 MHz to 2700 MHz                                      |      | 0.5  | 0.8  | dB   |
| RFC to Rx                   |        | f = 1805 MHz to 1910 MHz                                      |      | 0.4  | 0.7  | dB   |
|                             |        | f = 2010 MHz to 2025 MHz                                      |      | 0.3  | 0.6  | dB   |
|                             |        | f = 2300 MHz to 2480 MHz                                      |      | 1.1  | 1.5  | dB   |
|                             |        | f = 2500 MHz to 2700 MHz                                      |      | 0.7  | 1.1  | dB   |
| ISOLATION                   |        |   |      |      |      |      |
| Tx to RFC                   |        | f = 1805 MHz to 1910 MHz                                      | 15   | 23   |      | dB   |
|                             |        | f = 2010 MHz to 2025 MHz                                      | 14   | 22   |      | dB   |
|                             |        | f = 2300 MHz to 2480 MHz                                      | 15   | 20   |      | dB   |
|                             |        | f = 2500 MHz to 2700 MHz                                      | 10   | 15   |      | dB   |
| RFC to Rx                   |        | f = 1805 MHz to 1910 MHz                                      | 22   | 30   |      | dB   |
|                             |        | f = 2010 MHz to 2025 MHz                                      | 20   | 27   |      | dB   |
|                             |        | f = 2300 MHz to 2480 MHz                                      | 25   | 30   |      | dB   |
|                             |        | f = 2500 MHz to 2700 MHz                                      | 30   | 40   |      | dB   |
| RETURN LOSS                 |        |   |      |      |      |      |
| Tx to RFC                   |        | f = 1805 MHz to 1910 MHz                                      |      | 25   |      | dB   |
|                             |        | f = 2010 MHz to 2025 MHz                                      |      | 20   |      | dB   |
|                             |        | f = 2300 MHz to 2480 MHz                                      |      | 22   |      | dB   |
|                             |        | f = 2500 MHz to 2700 MHz                                      |      | 20   |      | dB   |
| RFC to Rx                   |        | f = 1805 MHz to 1910 MHz                                      |      | 25   |      | dB   |
|                             |        | f = 2010 MHz to 2025 MHz                                      |      | 25   |      | dB   |
|                             |        | f = 2300 MHz to 2480 MHz                                      |      | 10   |      | dB   |
|                             |        | f = 2500 MHz to 2700 MHz                                      |      | 12   |      | dB   |
| INPUT LINEARITY             |        |   |      |      |      |      |
| 0.1 dB Power Compression    | P0.1dB |   |      |      |      |      |
| Tx to RFC                   |        | f = 1805 MHz to 1910 MHz                                      | 38   | 40   |      | dBm  |
|                             |        | f = 2010 MHz to 2025 MHz                                      | 39   | 41   |      | dBm  |
|                             |        | f = 2300 MHz to 2480 MHz                                      | 36.5 | 38.5 |      | dBm  |
|                             |        | f = 2500 MHz to 2700 MHz                                      | 38.5 | 40.5 |      | dBm  |
| RFC to Rx                   |        | f = 1805 MHz to 1910 MHz                                      | 19   | 21   |      | dBm  |
|                             |        | f = 2010 MHz to 2025 MHz                                      | 19   | 21   |      | dBm  |
|                             |        | f = 2300 MHz to 2480 MHz                                      | 17   | 19   |      | dBm  |
|                             |        | f = 2500 MHz to 2700 MHz                                      | 18   | 20   |      | dBm  |
| Input Third-Order Intercept | IP3    | Two-tone input power = 19 dBm/tone, $\Delta f = 1\text{ MHz}$ |      |      |      |      |
| Tx to RFC                   |        | f = 1805 MHz to 1910 MHz                                      |      | 65   |      | dBm  |
|                             |        | f = 2010 MHz to 2025 MHz                                      |      | 64   |      | dBm  |
|                             |        | f = 2300 MHz to 2480 MHz                                      |      | 67   |      | dBm  |
|                             |        | f = 2500 MHz to 2700 MHz                                      |      | 62   |      | dBm  |

| Parameter   | Symbol               | Test Conditions/Comments                                      | Min | Typ | Max | Unit |
|---|----------------------|---|-----|-----|-----|------|
| RFC to Rx   |                      | f = 1805 MHz to 1910 MHz                                      |     | 33  |     | dBm  |
|   |                      | f = 2010 MHz to 2025 MHz                                      |     | 32  |     | dBm  |
|   |                      | f = 2300 MHz to 2480 MHz                                      |     | 33  |     | dBm  |
|   |                      | f = 2500 MHz to 2700 MHz                                      |     | 32  |     | dBm  |
| Input Third-Order Intercept, $V_{CTL} = 0\text{ V}/5\text{ V}$<br>Tx to RFC | IP3                  | Two-tone input power = 19 dBm/tone, $\Delta f = 1\text{ MHz}$ |     |     |     |      |
|   |                      | f = 1805 MHz to 1910 MHz                                      |     | 66  |     | dBm  |
|   |                      | f = 2010 MHz to 2025 MHz                                      |     | 64  |     | dBm  |
|   |                      | f = 2300 MHz to 2480 MHz                                      |     | 67  |     | dBm  |
| RFC to Rx   |                      | f = 2500 MHz to 2700 MHz                                      |     | 62  |     | dBm  |
|   |                      | f = 1805 MHz to 1910 MHz                                      |     | 44  |     | dBm  |
|   |                      | f = 2010 MHz to 2025 MHz                                      |     | 45  |     | dBm  |
|   |                      | f = 2300 MHz to 2480 MHz                                      |     | 45  |     | dBm  |
|   |                      | f = 2500 MHz to 2700 MHz                                      |     | 43  |     | dBm  |
| <b>SWITCHING CHARACTERISTICS</b>  |                      |   |     |     |     |      |
| Rise and Fall Time $t_{RISE}, t_{FALL}$                                     | $t_{RISE}, t_{FALL}$ | 10% to 90% of RF output                                       |     | 21  |     | ns   |
| On Time   | $t_{ON}$             | 50% $V_{CTL}$ to 90% of RF output                             |     | 102 |     | ns   |
| Off Time  | $t_{OFF}$            | 50% $V_{CTL}$ to 10% of RF output                             |     | 36  |     | ns   |

## ABSOLUTE MAXIMUM RATINGS

Table 2.

| Parameter  | Rating                     |
|--|----------------------------|
| Supply Voltage ( $V_{DD}$ )                        | 10 V                       |
| Control Voltage Range ( $V_{CTL}$ )                | -0.2 V to $V_{DD}$ to +1 V |
| RF Input Power, CW peak <sup>1</sup>               |                            |
| Tx Port, $V_{DD} = 3$ V and $V_{DD} = 5$ V         | 40 dBm                     |
| Rx Port, $V_{DD} = 3$ V                            | 24 dBm                     |
| Rx Port, $V_{DD} = 5$ V                            | 29 dBm                     |
| Hot Switch   | 24 dBm                     |
| Continuous Power Dissipation ( $P_{DISS}$ )        |                            |
| Tx Port, $V_{DD} = 3$ V and $V_{DD} = 5$ V         | 1.12 W                     |
| Rx Port, $V_{DD} = 3$ V                            | 73 mW                      |
| Rx Port, $V_{DD} = 5$ V                            | 232 mW                     |
| Junction to Case Thermal Resistance, $\theta_{JC}$ |                            |
| Tx Port, $V_{DD} = 3$ V and $V_{DD} = 5$ V         | 54°C/W                     |
| Rx Port, $V_{DD} = 3$ V                            | 68°C/W                     |
| Rx Port, $V_{DD} = 5$ V                            | 86°C/W                     |
| Temperature  |                            |
| Junction, $T_J$                                    | 150°C                      |
| Storage  | -65°C to +150°C            |
| Reflow (MSL1 Rating)                               | 260°C                      |
| ESD Sensitivity                                    |                            |
| Human Body Model (HBM)                             | 250 V (Class 1A)           |

<sup>1</sup> Maximum input power can be higher when the radio frequency (RF) input is pulsed with a duty cycle <100%.

Stresses at or above those listed under Absolute Maximum Ratings may cause permanent damage to the product. This is a stress rating only; functional operation of the product at these or any other conditions above those indicated in the operational section of this specification is not implied. Operation beyond the maximum operating conditions for extended periods may affect product reliability.

### ESD CAUTION



**ESD (electrostatic discharge) sensitive device.** Charged devices and circuit boards can discharge without detection. Although this product features patented or proprietary protection circuitry, damage may occur on devices subjected to high energy ESD. Therefore, proper ESD precautions should be taken to avoid performance degradation or loss of functionality.

### PIN CONFIGURATION AND FUNCTION DESCRIPTIONS

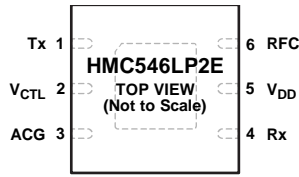

NOTES  
 1. EXPOSED PAD. THE PACKAGE BOTTOM HAS AN EXPOSED METAL PADDLE THAT MUST BE CONNECTED TO THE PRINTED CIRCUIT BOARD (PCB) RF GROUND.

13875-002

Figure 2. Pin Configuration

Table 3. Pin Function Descriptions

| Pin No. | Mnemonic         | Description   |
|---------|------------------|---|
| 1       | Tx               | Radio Frequency (RF) Transmit. This pin is dc- coupled and not well matched to 50 Ω. External matching components and a dc blocking capacitor are required. |
| 2       | V <sub>CTL</sub> | Control Voltage Input. For more information about the V <sub>CTL</sub> pin, see Table 4 and Figure 3.   |
| 3       | ACG              | AC Ground. An external capacitor from ACG to ground is required.  |
| 4       | Rx               | RF Receive. This pin is dc-coupled and not well matched to 50 Ω. External matching components and a dc blocking capacitor are required.                     |
| 5       | V <sub>DD</sub>  | Supply Voltage. See Figure 4 for the interface schematic.   |
| 6       | RFC              | RF Common. This pin is dc-coupled and not well matched to 50 Ω. External matching components and a dc blocking capacitor are required.                      |
|         | EPAD             | Exposed Pad. The package bottom has an exposed metal paddle that must be connected to the printed circuit board (PCB) RF ground.                            |

Table 4. Truth Table

| Control Input <sup>1</sup> |                 | Signal Path State |           |
|----------------------------|-----------------|-------------------|-----------|
| V <sub>CTL</sub>           | V <sub>DD</sub> | RFC to Tx         | RFC to Rx |
| 0V                         | V <sub>DD</sub> | Off               | On        |
| V <sub>DD</sub>            | V <sub>DD</sub> | On                | Off       |
| 0V                         | 0V              | On                | Off       |
| High-Z                     | High-Z          | On                | Off       |

<sup>1</sup> V<sub>DD</sub> = 3 V to 8 V, and control input voltage tolerances are ±0.2 V dc.

### INTERFACE SCHEMATICS

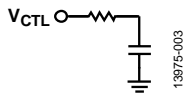

Figure 3. V<sub>CTL</sub> Interface

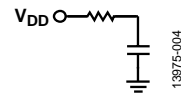

Figure 4. V<sub>DD</sub> Interface

# TYPICAL PERFORMANCE CHARACTERISTICS

## 1843 MHz TUNING

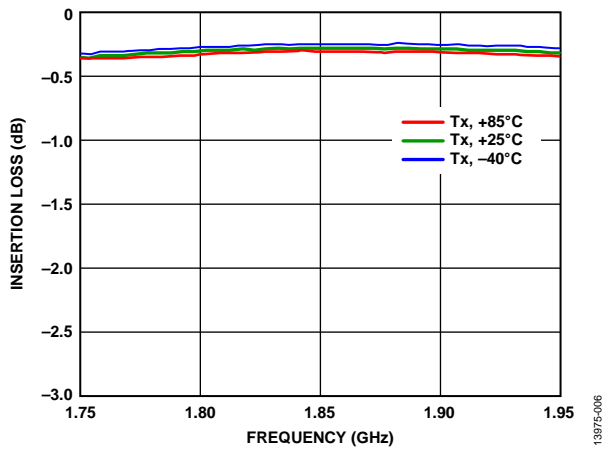

Figure 5. Tx to RFC Insertion Loss vs. Frequency over Temperature

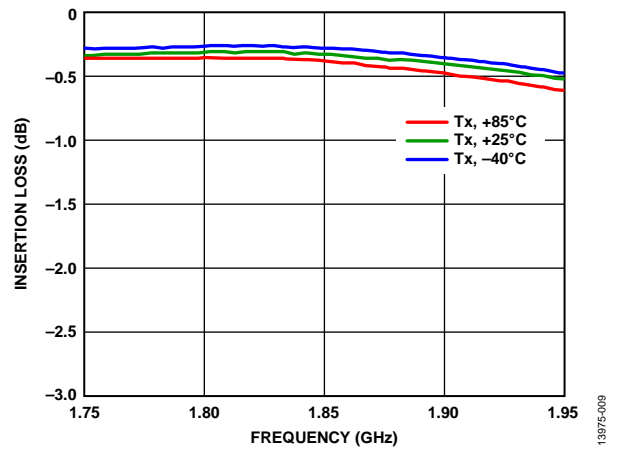

Figure 8. RFC to Rx Insertion Loss vs. Frequency over Temperature

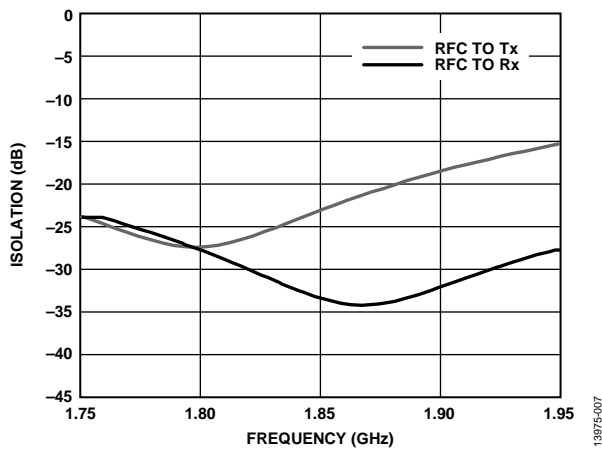

Figure 6. Isolation vs. Frequency

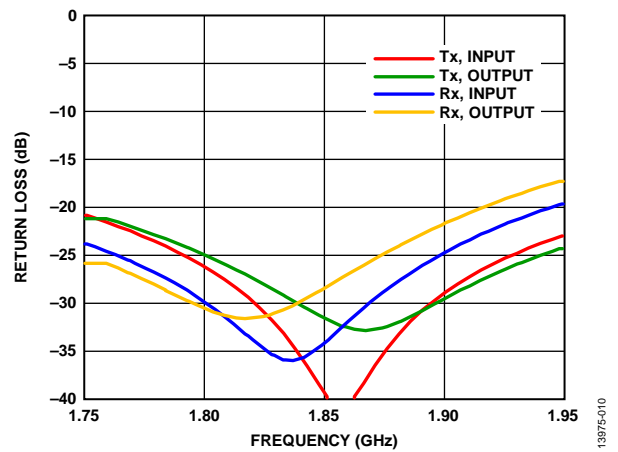

Figure 9. Return Loss vs. Frequency

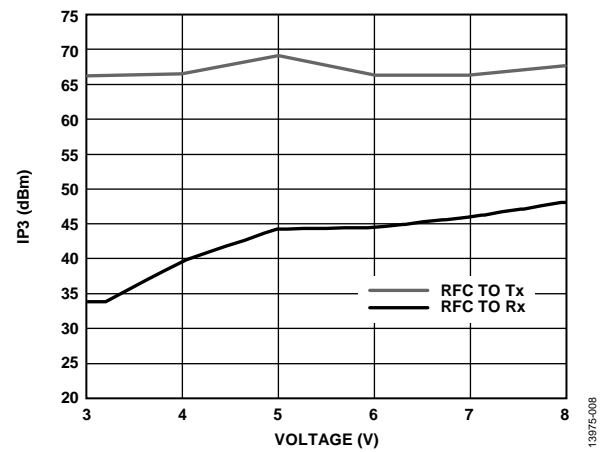

Figure 7. Input IP3 vs. Voltage

13975-006

13975-009

13975-007

13975-010

13975-008

## 2015 MHZ TUNING

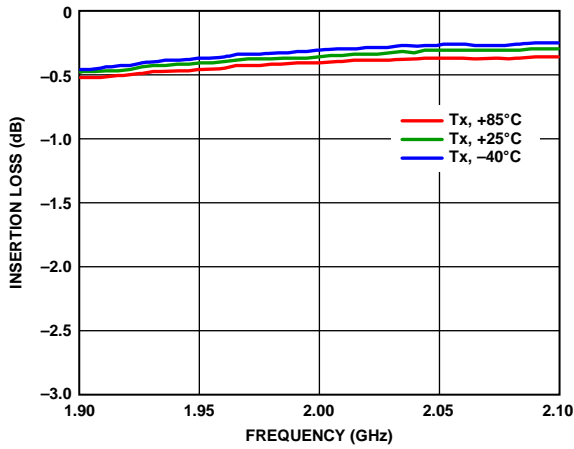

Figure 10. Tx to RFC Insertion Loss vs. Frequency over Temperature

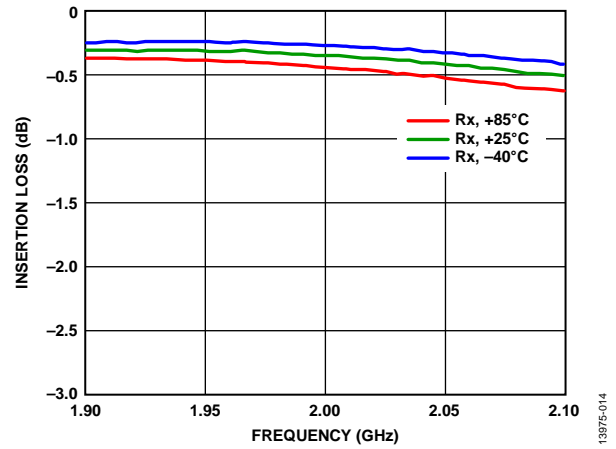

Figure 13. RFC to Rx Insertion Loss vs. Frequency over Temperature

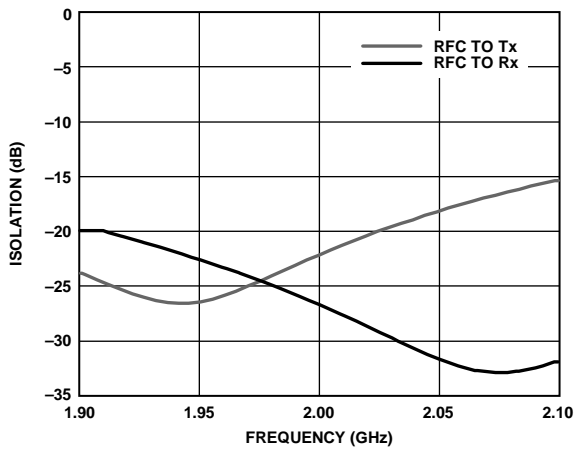

Figure 11. Isolation vs. Frequency

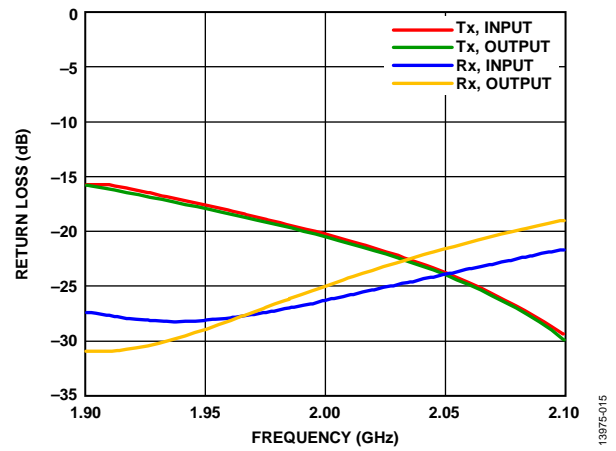

Figure 14. Return Loss vs. Frequency

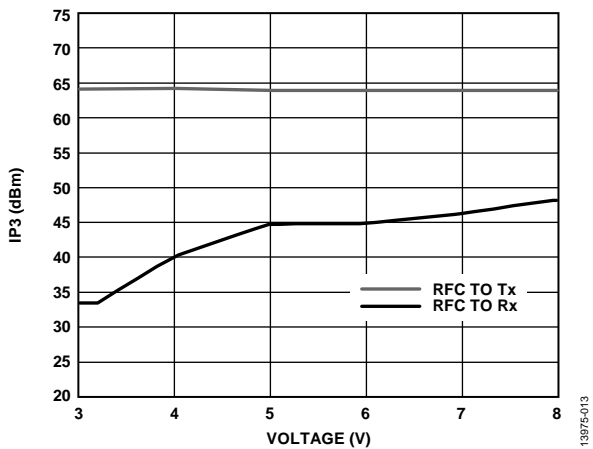

Figure 12. Input IP3 vs. Voltage

13975-011

13975-014

13975-012

13975-015

13975-013

2350 MHZ TUNING

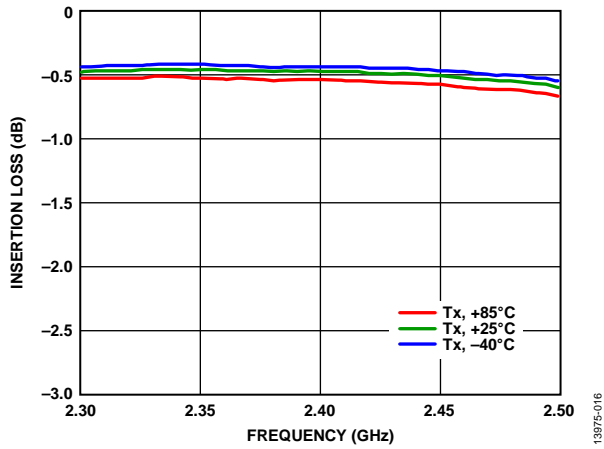

Figure 15. Tx to RFC Insertion Loss vs. Frequency over Temperature

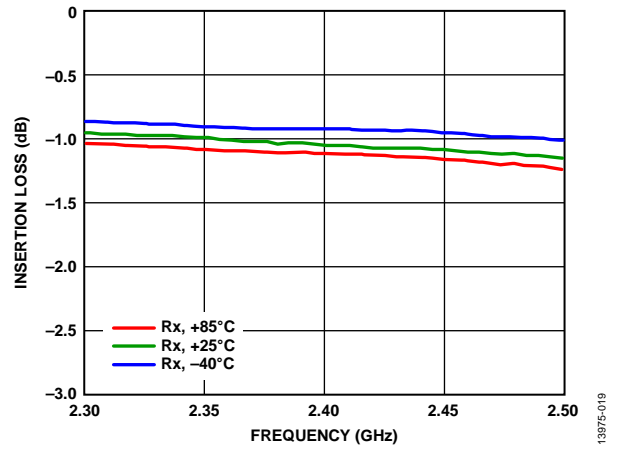

Figure 18. RFC to Rx Insertion Loss vs. Frequency over Temperature

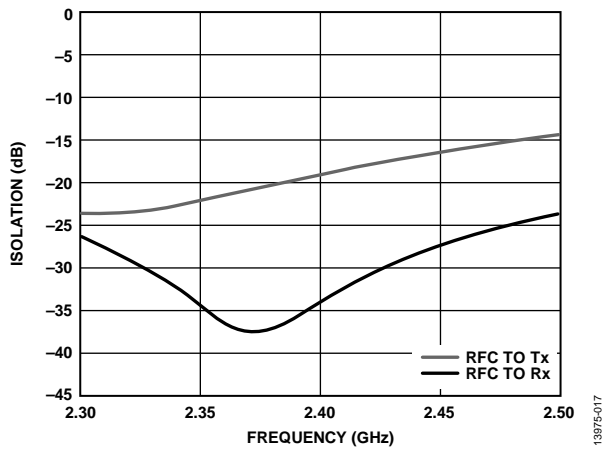

Figure 16. Isolation vs. Frequency

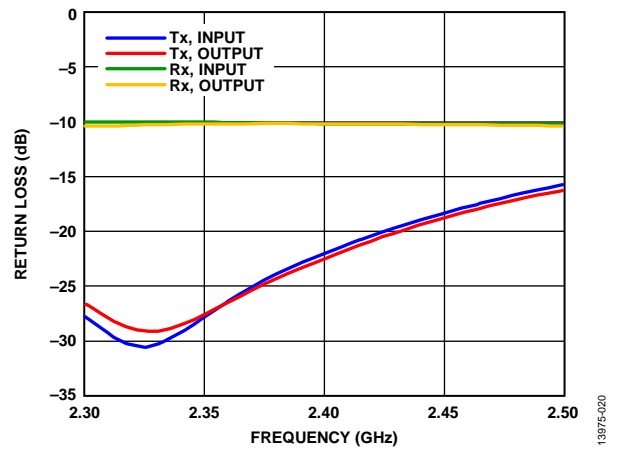

Figure 19. Return Loss vs. Frequency

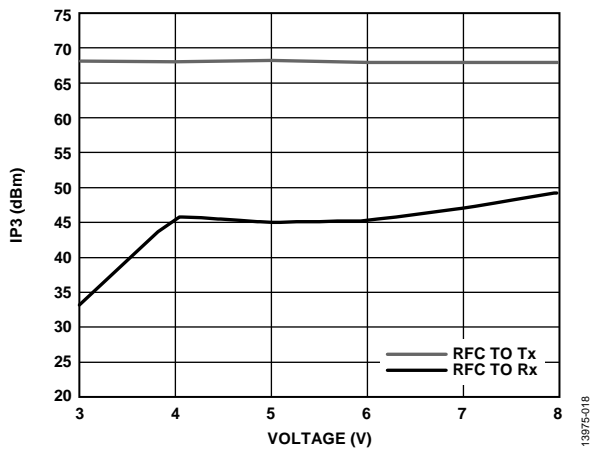

Figure 17. Input IP3 vs. Voltage

13975-016

13975-019

13975-017

13975-020

13975-018

## 2600 MHz TUNING

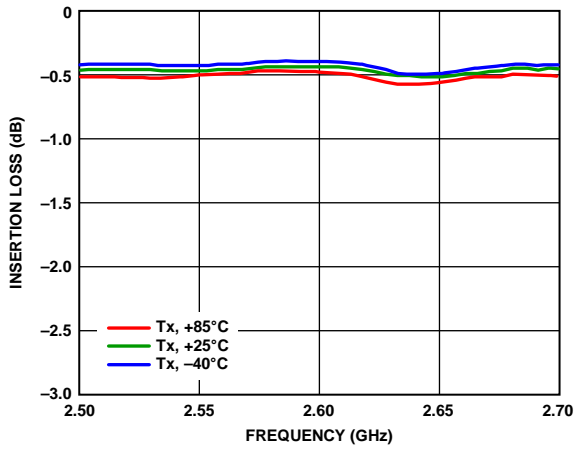

Figure 20. Tx to RFC Insertion Loss vs. Frequency over Temperature

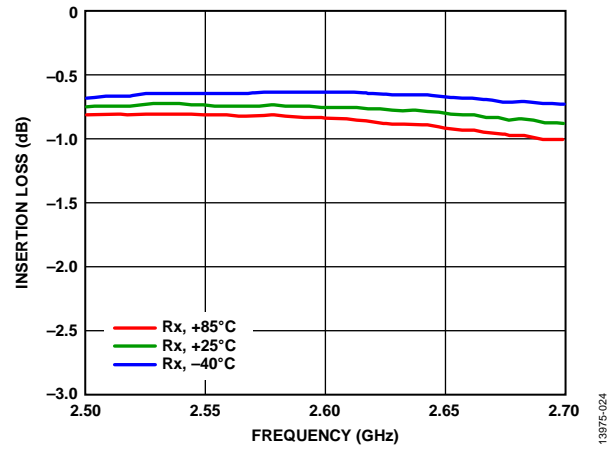

Figure 23. RFC to Rx Insertion Loss vs. Frequency over Temperature

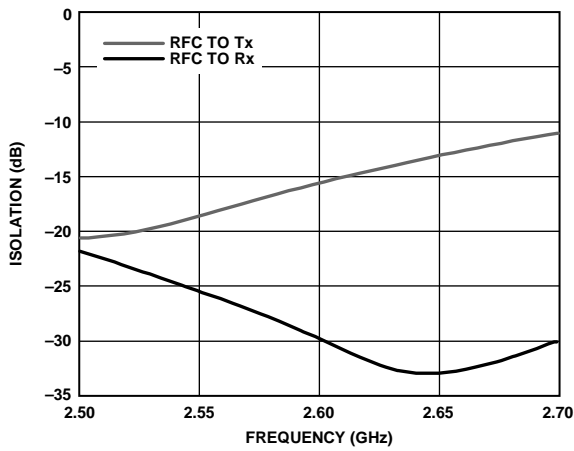

Figure 21. Isolation vs. Frequency

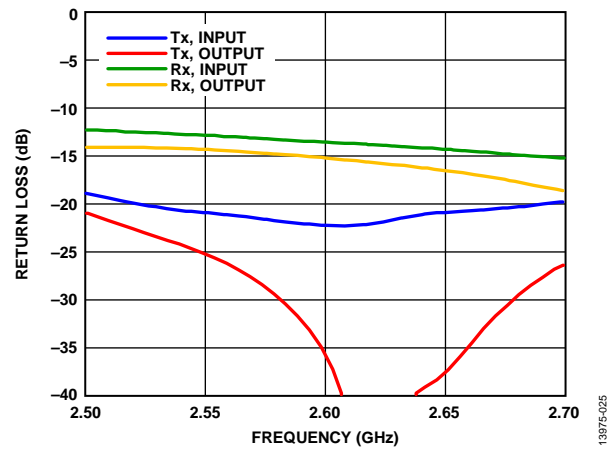

Figure 24. Return Loss vs. Frequency

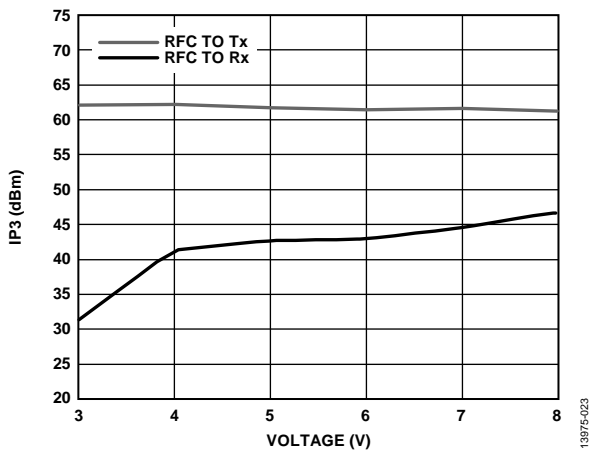

Figure 22. Input IP3 vs. Voltage

13975-021

13975-024

13975-022

13975-025

13975-023

## APPLICATIONS INFORMATION

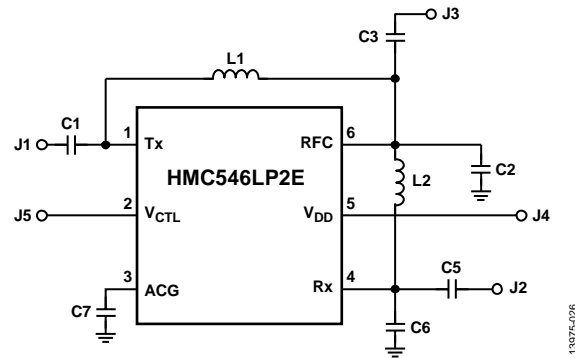

Figure 25. Applications Circuit

## COMPONENTS FOR SELECTED FREQUENCIES

Table 5. Evaluation Board Components by Frequency

| Component               | Tuned Frequency <sup>1</sup> |          |          |          |
|-------------------------|------------------------------|----------|----------|----------|
|                         | 1843 MHz                     | 2015 MHz | 2350 MHz | 2600 MHz |
| C1, C3, C5 <sup>2</sup> | 330 pF                       | 330 pF   | 330 pF   | 330 pF   |
| C2                      | 1.2 pF                       | 0.8 pF   | 0.6 pF   | 0.7 pF   |
| C6                      | 0.5 pF                       | N/A      | N/A      | N/A      |
| C7                      | 3.0 pF                       | 2.4 pF   | 2.0 pF   | 1.5 pF   |
| L1 <sup>3, 4</sup>      | 5.1 nH                       | 4.3 nH   | 2.0 nH   | 1.6 nH   |
| L2 <sup>5</sup>         | 4.3 nH                       | 3.9 nH   | 3.3 nH   | 2.7 nH   |

<sup>1</sup> N/A means not applicable.<sup>2</sup> DC blocking capacitors.<sup>3</sup> 0402 inductors, 5% tolerance; for tuned frequencies of 1843 MHz, 2015 MHz, and 2350 MHz.<sup>4</sup> 0603 inductor, 5% tolerance; for tuned frequency of 2600 MHz only.<sup>5</sup> 0402 inductor, 5% tolerance; for all tuned frequency levels.

**EVALUATION PCB**

When using the circuit board in an application, generate proper RF circuit design techniques. Ensure that signal lines have 50 Ω impedance and that the package ground leads and exposed paddle are connected directly to the ground plane, as shown in Figure 26. The evaluation circuit board shown in Figure 26 is available from Analog Devices, Inc., upon request.

**Bill of Materials**

**Table 6. Bill of Materials<sup>1</sup>**

| Item <sup>2</sup> | Description                          |
|-------------------|--------------------------------------|
| J1 to J3          | PCB mount SMA RF connector           |
| J4 to J6          | DC pins                              |
| C1 to C3          | Capacitors, 0402 package             |
| L1, L2            | Inductors                            |
| U1                | HMC546LP2E transmit/receive switches |
| PCB <sup>3</sup>  | 110780 evaluation PCB                |

<sup>1</sup> When requesting an evaluation board, reference the appropriate evaluation PCB number listed in the Ordering Guide section.

<sup>2</sup> Refer to Table 5 for component values.

<sup>3</sup> Circuit board material: Rogers 4350.

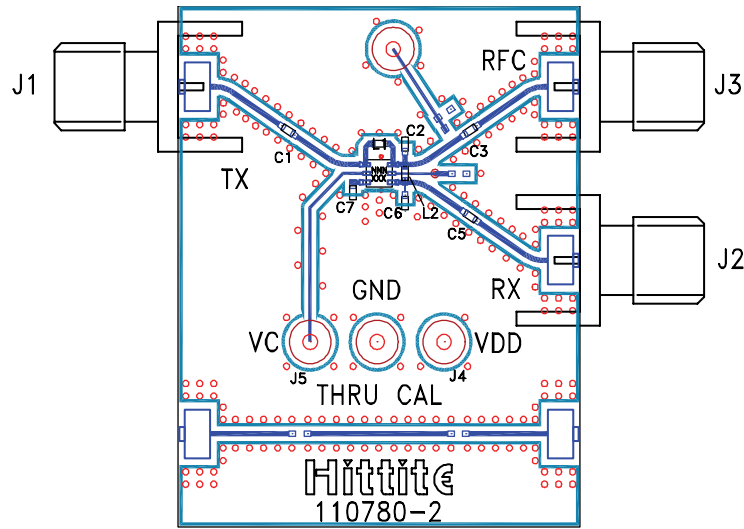

Figure 26. Evaluation Printed Circuit Board (PCB)

### OUTLINE DIMENSIONS

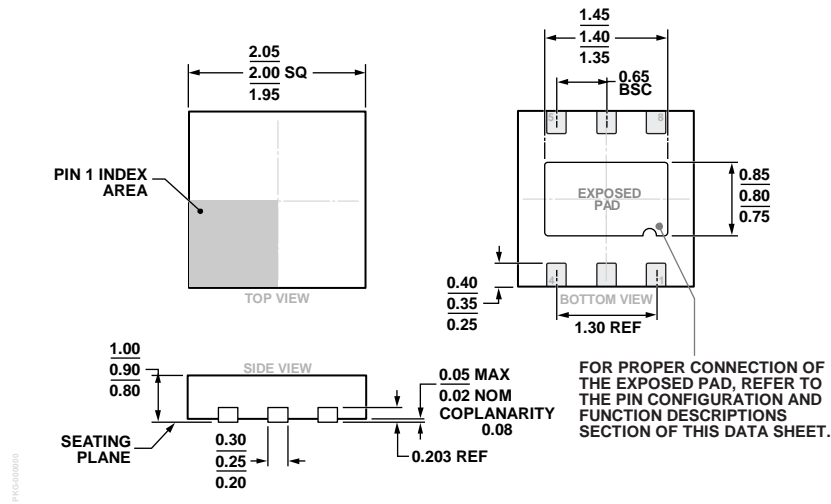

Figure 27. 6-Lead Lead Frame Chip Scale Package [LFCSP]  
 2 mm x 2mm Body and 0.90 mm Package Height  
 (CP-6-10)  
 Dimensions shown in millimeters

### ORDERING GUIDE

| Model <sup>1</sup> | Temperature Range | MSL Rating <sup>2</sup> | Package Description                          | Package Option | Package Marking <sup>3</sup> |
|--------------------|-------------------|-------------------------|--|----------------|------------------------------|
| HMC546LP2E         | -40°C to +85°C    | MSL1                    | 6-Lead Lead Frame Chip Scale Package [LFCSP] | CP-6-10        | 546<br>XXXX                  |
| HMC546LP2ETR       | -40°C to +85°C    | MSL1                    | 6-Lead Lead Frame Chip Scale Package [LFCSP] | CP-6-10        | 546<br>XXXX                  |
| 110782-HMC546LP2   |                   |                         | Evaluation Board, 1843 MHz Tune              |                |                              |
| 115201-HMC546LP2   |                   |                         | Evaluation Board, 2015 MHz Tune              |                |                              |
| 115202-HMC546LP2   |                   |                         | Evaluation Board, 2350 MHz Tune              |                |                              |
| 115203-HMC546LP2   |                   |                         | Evaluation Board, 2600 MHz Tune              |                |                              |

<sup>1</sup> HMC546LP2E and HMC546LP2ETR are RoHS compliant parts.  
<sup>2</sup> See the Absolute Maximum Ratings section.  
<sup>3</sup> XXXX is the 4-digit lot number.

## Looking for pricing, stock, or lifecycle information?

Click below to explore more details on WIN SOURCE:

 [View HMC546LP2E on WIN SOURCE](#)

 [Analog Devices Inc. Information](#)

## Optimize Your Supply Chain with WIN SOURCE Solutions

-  Global Sourcing Solution
-  Obsolete Management
-  Cost Control Management
-  Shortage Management
-  Alternative Solution
-  Excess Inventory Management