



**THE DATASHEET OF  
HMC5445LS6TR**





## GaAs pHEMT MMIC 1 WATT POWER AMPLIFIER, 24 - 27 GHz

### Typical Applications

The HMC5445LS6 is ideal for:

- Point-to-Point Radios
- Point-to-Multi-Point Radios
- VSAT
- Military & Space

### Features

- Saturated Output Power: +31.5 dBm @ 23% PAE
- High Output IP3: +40 dBm
- High Gain: 26 dB
- DC Supply: +6V @ 750 mA
- No External Matching Required
- 16 Lead Ceramic 6 x 6 mm SMT Package: 36 mm<sup>2</sup>

### Functional Diagram

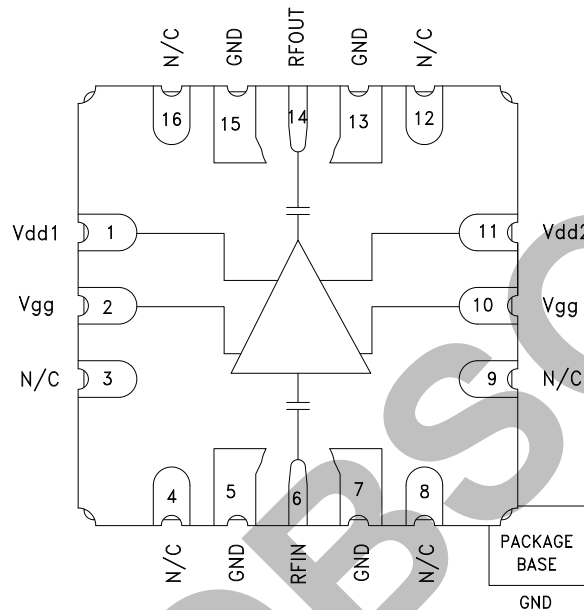

### General Description

The HMC5445LS6 is a three-stage GaAs pHEMT MMIC 1 Watt Power Amplifier which operates between 24 and 27 GHz. The HMC5445LS6 provides 26 dB of gain, and +31 dBm of saturated output power and 18% PAE from a +6V supply. The RF I/Os are DC blocked and matched to 50 Ohms for ease of integration into Multi-Function-Modules (MFMs). The HMC5445LS6 eliminates the need for wire bonding and allows the use of surface mount manufacturing techniques.

### Electrical Specifications, $T_A = +25^\circ\text{C}$ , $V_{dd} = V_{dd1} = V_{dd2} = +6\text{V}$ , $I_{dd} = 750\text{ mA}$ [1]

Parameter	Min.	Typ.	Max.	Units
Frequency Range	24 - 27			GHz
Gain	23	26		dB
Gain Variation Over Temperature		0.03		dB/°C
Input Return Loss		17		dB
Output Return Loss		17		dB
Output Power for 1 dB Compression (P1dB)	27	30.5		dBm
Saturated Output Power (P <sub>sat</sub> )		31.5		dBm
Output Third Order Intercept (IP <sub>3</sub> ) <sup>[2]</sup>		40		dBm
Total Supply Current (I <sub>dd</sub> )		750		mA

[1] Adjust V<sub>gg</sub> between -2 to 0V to achieve I<sub>dd</sub> = 750 mA typical.

[2] Measurement taken at +6V @ 750 mA, P<sub>out</sub> / Tone = +19 dBm



**GaAs pHEMT MMIC 1 WATT  
POWER AMPLIFIER, 24 - 27 GHz**

**Broadband Gain &  
Return Loss vs. Frequency**

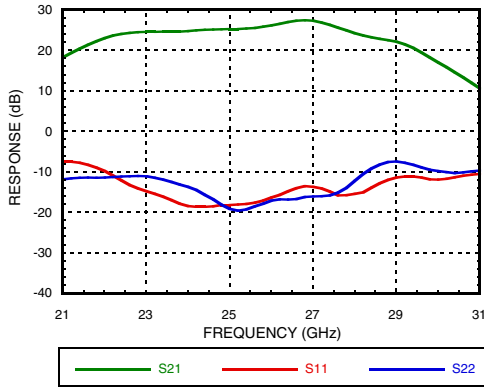

**Gain vs. Temperature**

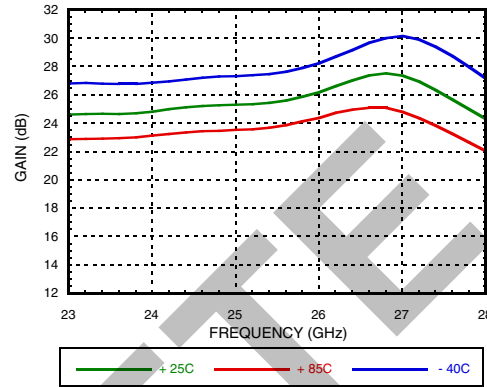

**Input Return Loss vs. Temperature**

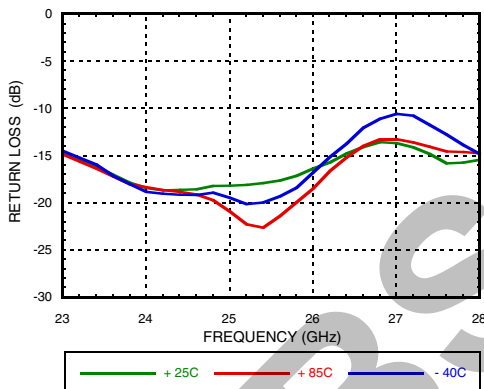

**Output Return Loss vs. Temperature**

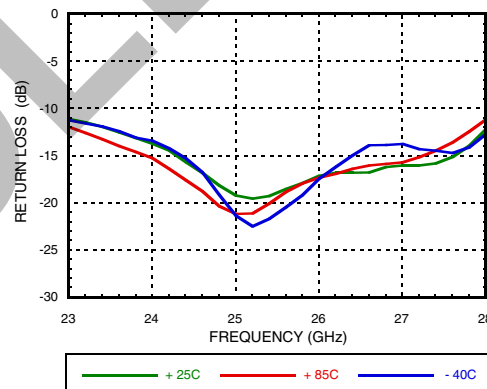

**P1dB vs. Temperature**

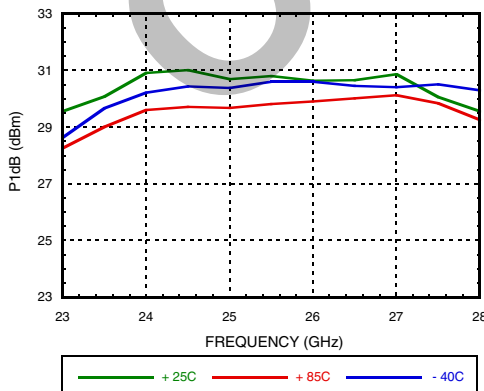

**P1dB vs. Supply Voltage**

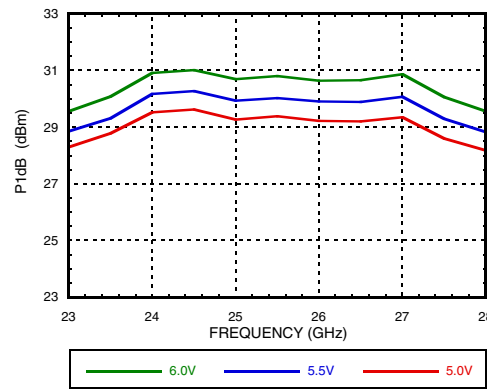

Information furnished by Analog Devices is believed to be accurate and reliable. However, no responsibility is assumed by Analog Devices for its use, nor for any infringements of patents or other rights of third parties that may result from its use. Specifications subject to change without notice. No license is granted by implication or otherwise under any patent or patent rights of Analog Devices. Trademarks and registered trademarks are the property of their respective owners.

For price, delivery, and to place orders: Analog Devices, Inc., One Technology Way, P.O. Box 9106, Norwood, MA 02062-9106 Phone: 781-329-4700 • Order online at [www.analog.com](http://www.analog.com) Application Support: Phone: 1-800-ANALOG-D



**GaAs pHEMT MMIC 1 WATT POWER AMPLIFIER, 24 - 27 GHz**

AMPLIFIER - LINEAR & POWER - SMT

**Psat vs. Temperature**

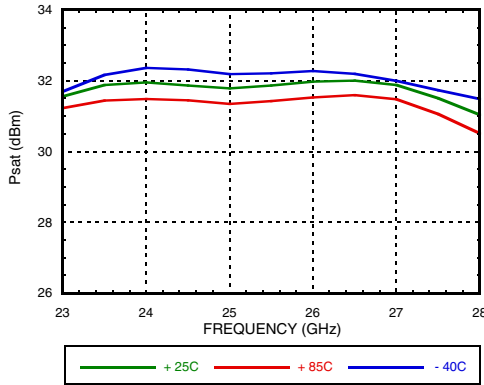

**Psat vs. Supply Voltage**

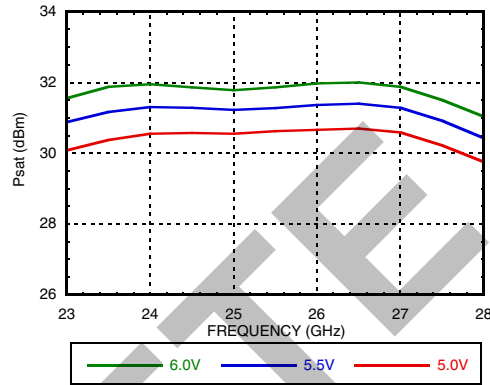

**P1dB vs. Supply Current (Idd)**

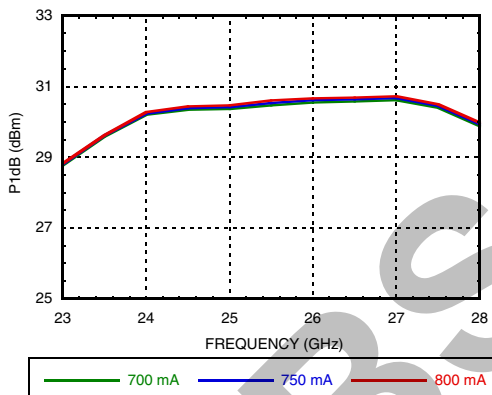

**Psat vs. Supply Current (Idd)**

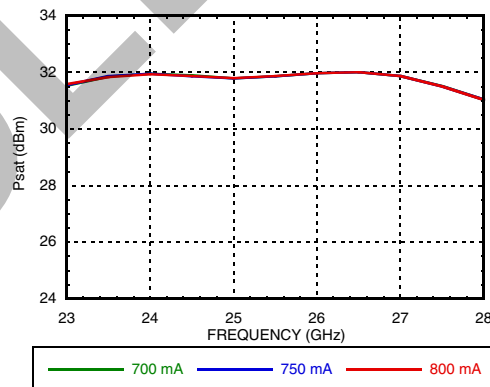

**Output IP3 vs. Temperature, Pout/Tone = +19 dBm**

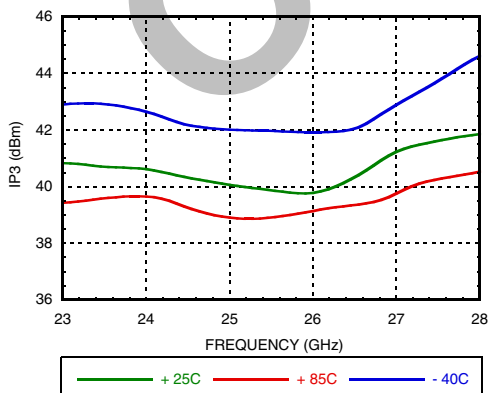

**Output IP3 vs. Supply Current, Pout/Tone = +19 dBm**

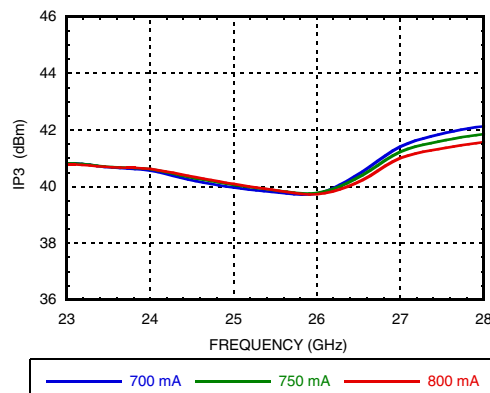

Information furnished by Analog Devices is believed to be accurate and reliable. However, no responsibility is assumed by Analog Devices for its use, nor for any infringements of patents or other rights of third parties that may result from its use. Specifications subject to change without notice. No license is granted by implication or otherwise under any patent or patent rights of Analog Devices. Trademarks and registered trademarks are the property of their respective owners.

For price, delivery, and to place orders: Analog Devices, Inc., One Technology Way, P.O. Box 9106, Norwood, MA 02062-9106 Phone: 781-329-4700 • Order online at [www.analog.com](http://www.analog.com) Application Support: Phone: 1-800-ANALOG-D



**GaAs pHEMT MMIC 1 WATT POWER AMPLIFIER, 24 - 27 GHz**

**Output IP3 vs. Supply Voltage, Pout/Tone = +19 dBm**

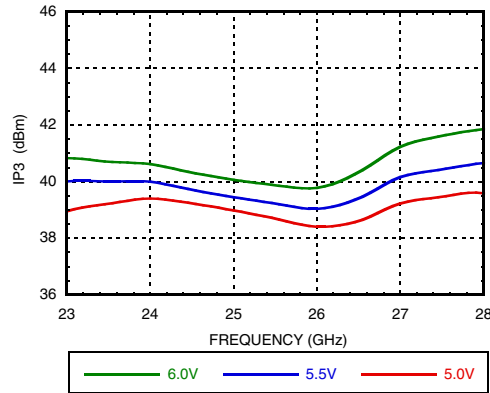

**Output IM3 @ Vdd = +5V**

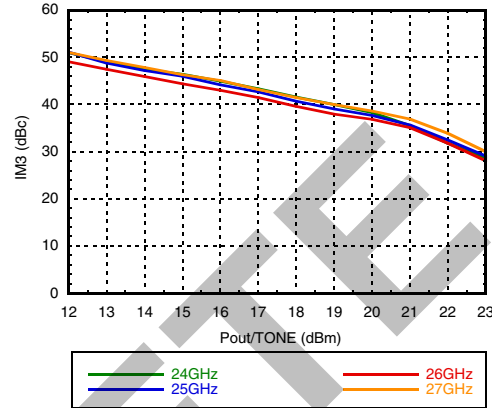

**Output IM3 @ Vdd = +5.5V**

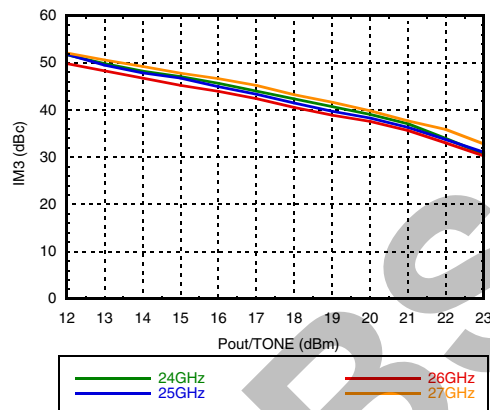

**Output IM3 @ Vdd = +6V**

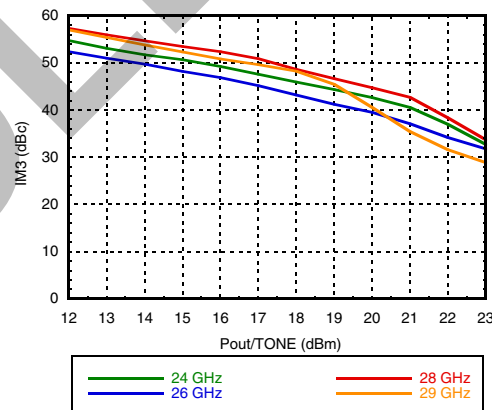

**Power Compression @ 26 GHz**

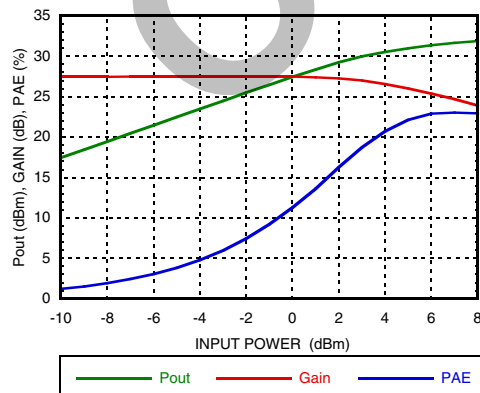

**Reverse Isolation vs. Temperature**

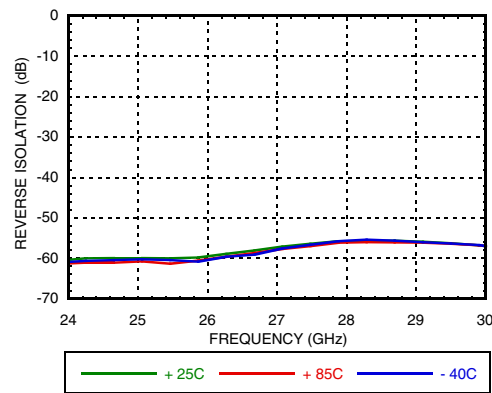

Information furnished by Analog Devices is believed to be accurate and reliable. However, no responsibility is assumed by Analog Devices for its use, nor for any infringements of patents or other rights of third parties that may result from its use. Specifications subject to change without notice. No license is granted by implication or otherwise under any patent or patent rights of Analog Devices. Trademarks and registered trademarks are the property of their respective owners.

For price, delivery, and to place orders: Analog Devices, Inc., One Technology Way, P.O. Box 9106, Norwood, MA 02062-9106 Phone: 781-329-4700 • Order online at [www.analog.com](http://www.analog.com) Application Support: Phone: 1-800-ANALOG-D



**GaAs pHEMT MMIC 1 WATT  
POWER AMPLIFIER, 24 - 27 GHz**

**Gain & Power vs.  
Supply Current @ 27 GHz**

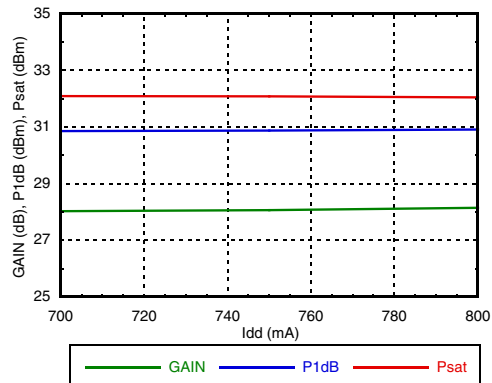

**Gain & Power vs.  
Supply Voltage @ 27 GHz**

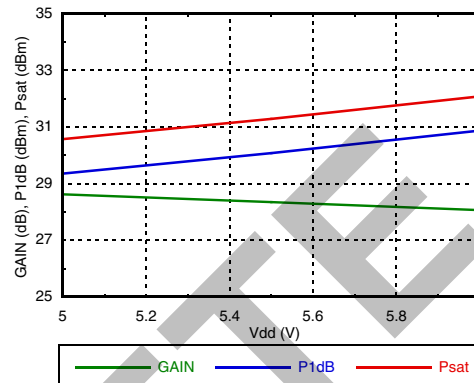

**Power Dissipation**

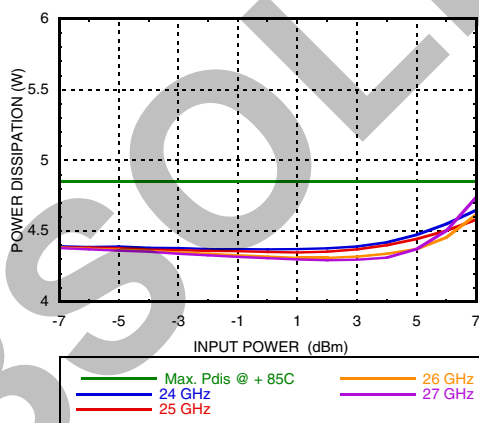

Information furnished by Analog Devices is believed to be accurate and reliable. However, no responsibility is assumed by Analog Devices for its use, nor for any infringements of patents or other rights of third parties that may result from its use. Specifications subject to change without notice. No license is granted by implication or otherwise under any patent or patent rights of Analog Devices. Trademarks and registered trademarks are the property of their respective owners.

For price, delivery, and to place orders: Analog Devices, Inc., One Technology Way, P.O. Box 9106, Norwood, MA 02062-9106 Phone: 781-329-4700 • Order online at [www.analog.com](http://www.analog.com) Application Support: Phone: 1-800-ANALOG-D



## GaAs pHEMT MMIC 1 WATT POWER AMPLIFIER, 24 - 27 GHz

### Absolute Maximum Ratings

Drain Bias Voltage (Vd)	+6.3V
RF Input Power (RFIN)	+23 dBm
Channel Temperature	+150 °C
Continuous Pdis (T=85 °C) (derate 72 mW/°C above 85 °C)	4.7 W
Thermal Resistance (Channel to ground paddle)	13.83 °C/W
Storage Temperature	-65 to +150 °C
Operating Temperature	-40 to +85 °C
ESD Rating	Class 0

### Reliability Information

Junction Temperature to Maintain 1 Million Hour MTTF	150 °C
Nominal Junction Temperature (T = 85 °C and Pin = 10 dBm)	90 °C
Operating Temperature	-40 to +85 °C



**ELECTROSTATIC SENSITIVE DEVICE  
OBSERVE HANDLING PRECAUTIONS**

### Outline Drawing

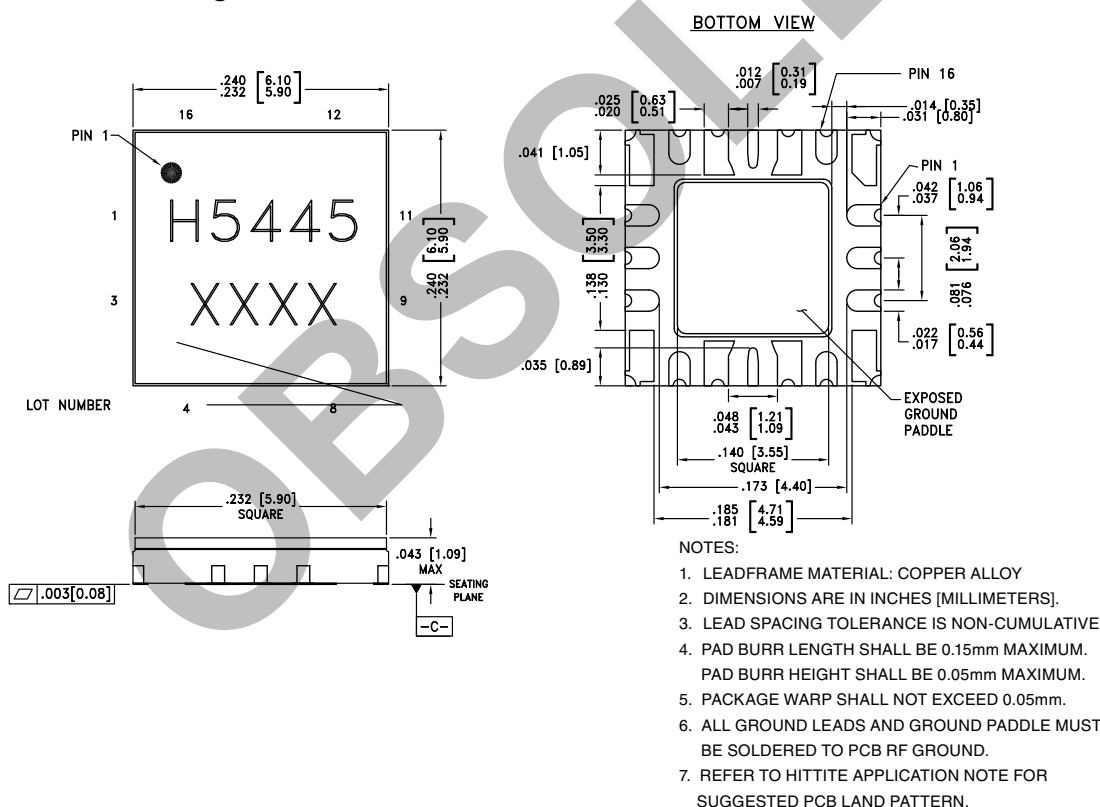

### Package Information

Part Number	Package Body Material	Lead Finish	MSL Rating <sup>[2]</sup>	Package Marking <sup>[1]</sup>
HMC5445LS6	ALUMINA WHITE	Gold over Nickel	N/A	H5445 XXXX

[1] 4-Digit lot number XXXX

[2] Max peak reflow temperature of 260 °C



## GaAs pHEMT MMIC 1 WATT POWER AMPLIFIER, 24 - 27 GHz

### Pin Descriptions

Pin Number	Function	Description	Interface Schematic
1, 11	Vdd1, Vdd2	Drain bias voltage. External bypass capacitors of 100 pF, 0.1 μF and 4.7 μF are required for each pin.	
2, 10	Vgg	Gate control for PA. Adjust Vgg to achieve recommended bias current. Only one pin is required. External bypass caps 100 pF, 0.1 μF and 4.7 μF are required.	
3, 4, 8, 9, 12, 16	N/C	The pins are not connected internally; however, all data shown herein was measured with these pins connected to RF/DC ground externally.	
5, 7, 13, 15	GND	These pins and exposed paddle must be connected to RF/DC ground.	
6	RFIN	This pin is AC coupled and matched to 50 Ohms.	
14	RFOUT	This pin is AC coupled and matched to 50 Ohms.	

### Application Circuit

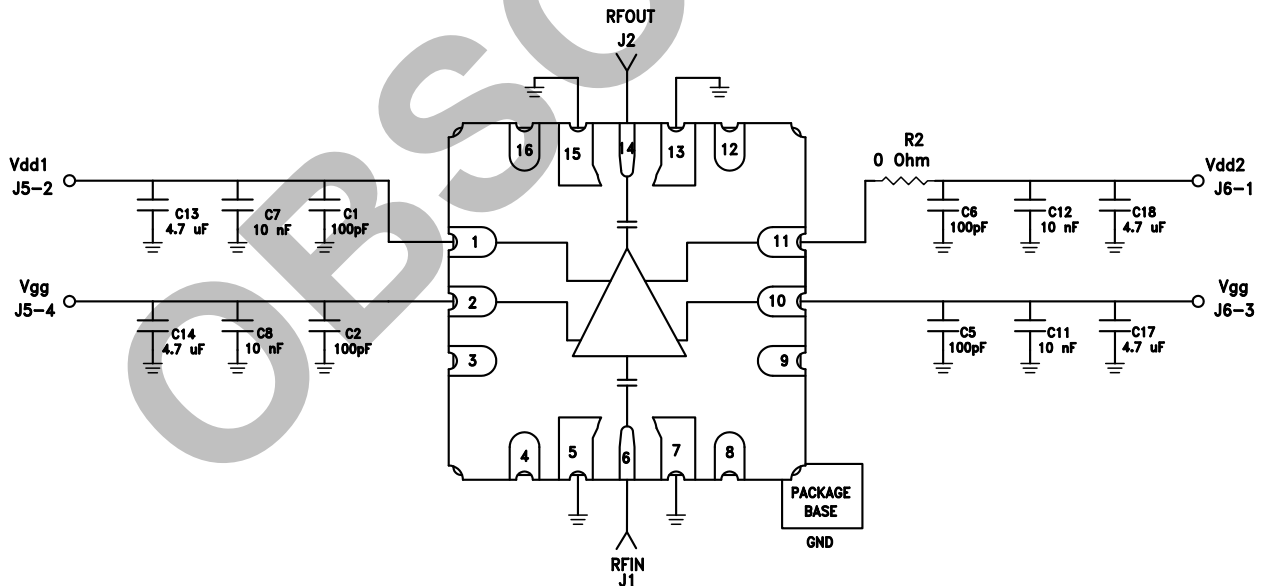

NOTE: Vgg – only one connection is required



**GaAs pHEMT MMIC 1 WATT  
POWER AMPLIFIER, 24 - 27 GHz**

**Evaluation PCB**

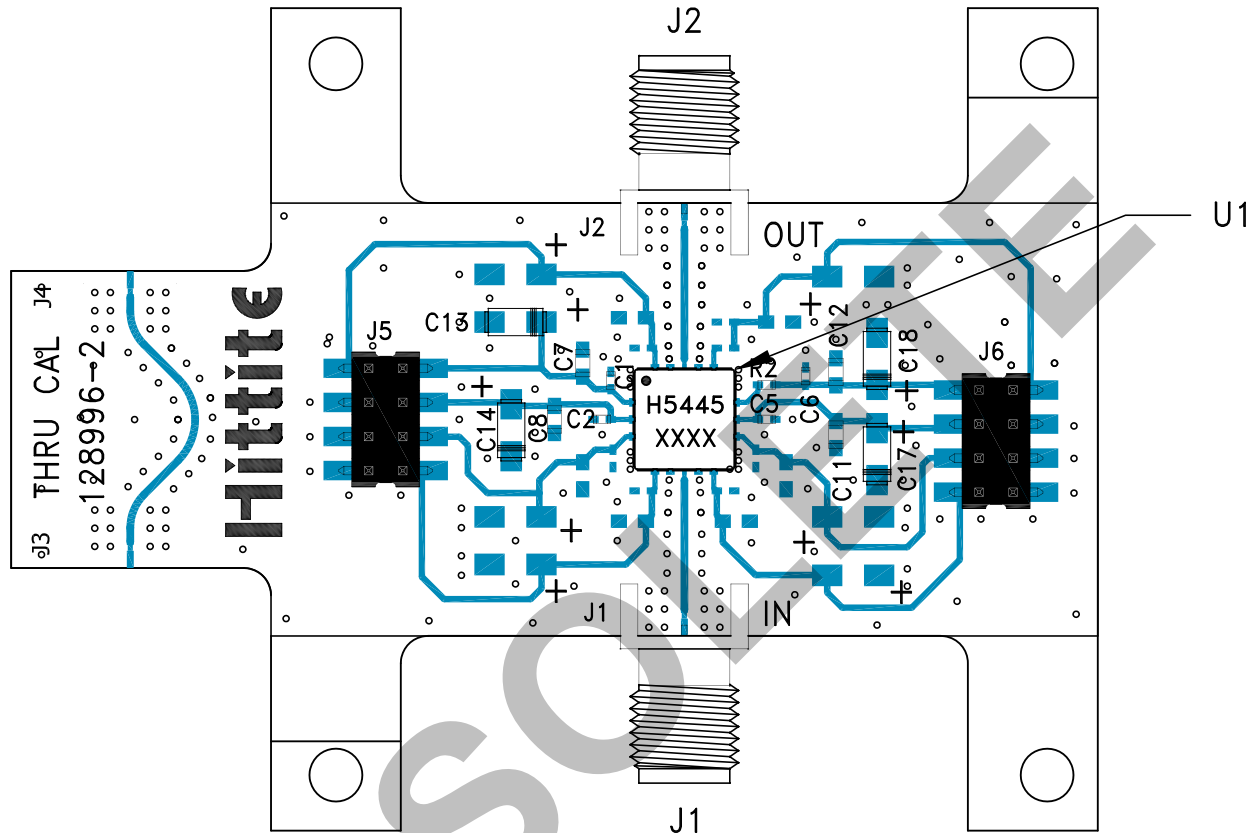

**List of Materials for Evaluation PCB EVAL01-HMC5445LS6 [1]**

Item	Description
J1, J2	"K" Connector, SRI
J5, J6	DC Pin
C1, C2, C5, C6	100 pF Capacitor, 0402 Pkg.
C7, C8, C11, C12	10000 pF Capacitor, 0603 Pkg.
C13, C14, C17, C18	4.7 μF Capacitor, ? Pkg.
R2	0 Ohm Resistor, 0402 Pkg.
U1	HMC5445LS6 Amplifier
PCB [2]	128996 Eval Board

[1] Reference this number when ordering complete evaluation PCB

[2] Circuit Board Material: Rogers 4350

The circuit board used in the application should use RF circuit design techniques. Signal lines should have 50 Ohm impedance while the package ground leads and exposed paddle should be connected directly to the ground plane similar to that shown. A sufficient number of via holes should be used to connect the top and bottom ground planes. The evaluation board should be mounted to an appropriate heat sink. The evaluation circuit board shown is available from Hittite upon request.

## Looking for pricing, stock, or lifecycle information?

Click below to explore more details on WIN SOURCE:

 [View HMC5445LS6TR on WIN SOURCE](#)

 [Analog Devices Inc. Information](#)

## Optimize Your Supply Chain with WIN SOURCE Solutions

-  Global Sourcing Solution
-  Obsolete Management
-  Cost Control Management
-  Shortage Management
-  Alternative Solution
-  Excess Inventory Management