



THE DATASHEET OF HMC435AMS8GE





SPDT NON-REFLECTIVE SWITCH, DC - 4 GHz

Typical Applications

The HMC435AMS8G(E) is ideal for:

- Basestations & Repeaters
- Cellular/3G and WiMAX/4G
- Infrastructure and Access Points
- CATV/CMTS
- Test Instrumentation

Features

- High Isolation: 62 dB @ 1 GHz
52 dB @ 2 GHz
- Single Positive Control: 0/+5V
- Input IP3: 54 dBm
- Non-Reflective Design
- Ultra Small MSOP-86 Package: 14.8 mm²

Functional Diagram

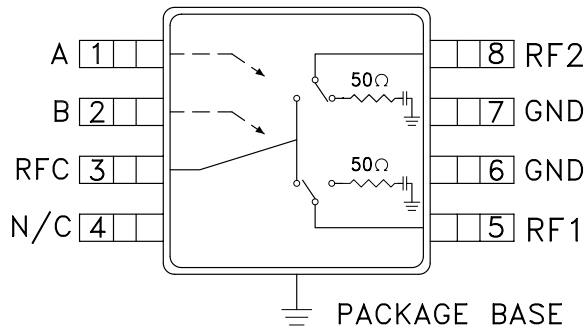

General Description

The HMC435AMS8G(E) is a non-reflective DC to 4 GHz GaAs MESFET SPDT switch in a low cost 8 lead MSOP8G surface mount package with exposed ground paddle. The switch is ideal for cellular/3G and WiMAX/4G applications yielding up to 60 dB isolation, low 0.8 dB insertion loss and +50 dBm input IP3. Power handling is excellent up through the 3.8 GHz WiMAX band with the switch offering a P1dB compression of +30 dBm. On-chip circuitry allows positive voltage control of 0/+5 Volts at very low DC currents.

Electrical Specifications, $T_A = +25^\circ\text{C}$, $V_{ctl} = 0/+5\text{Vdc}$, 50 Ohm System

Parameter	Frequency	Min.	Typ.	Max.	Units
Insertion Loss	DC - 2.5 GHz		0.8	1.0	dB
	DC - 3.6 GHz		1.0	1.5	dB
	DC - 4.0 GHz		1.2	1.8	dB
Isolation (RFC to RF1/RF2)	DC - 1.0 GHz	56	62		dB
	DC - 2.0 GHz	46	52		dB
	DC - 2.5 GHz	43	48		dB
	DC - 3.6 GHz	37	42		dB
	DC - 4.0 GHz	30	40		dB
Return Loss (On State)	DC - 2.5 GHz	15	23		dB
	DC - 3.6 GHz	13	17		dB
	DC - 4.0 GHz	11	14		dB
Return Loss (Off State)	0.5 - 4.0 GHz	16	21		dB
Input Power for 1 dB Compression	0.5 - 4.0 GHz	27	30		dBm
Input Third Order Intercept (Two-Tone Input Power = +7 dBm Each Tone)	0.5 - 1.0 GHz	48	54		dBm
	0.5 - 2.5 GHz	45	53		dBm
	0.5 - 4.0 GHz	41	51		dBm
Switching Speed	DC - 4.0 GHz				
		tRISE, tFALL (10/90% RF) tON, tOFF (50% CTL to 10/90% RF)		40 60	ns ns



SPDT NON-REFLECTIVE SWITCH, DC - 4 GHz

Insertion Loss

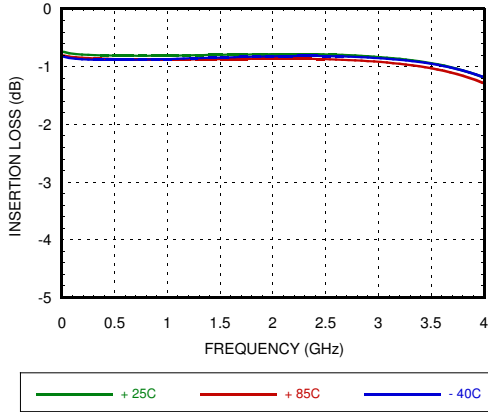

Return Loss

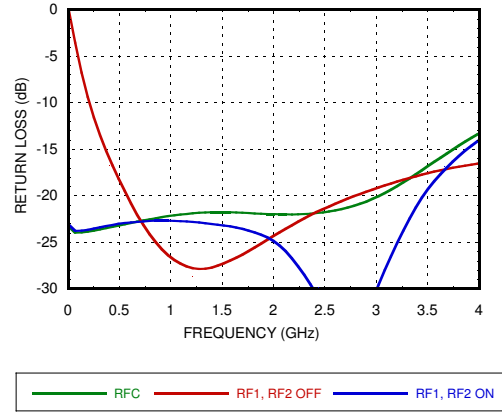

Isolation Between Ports RFC and RF1 / RF2

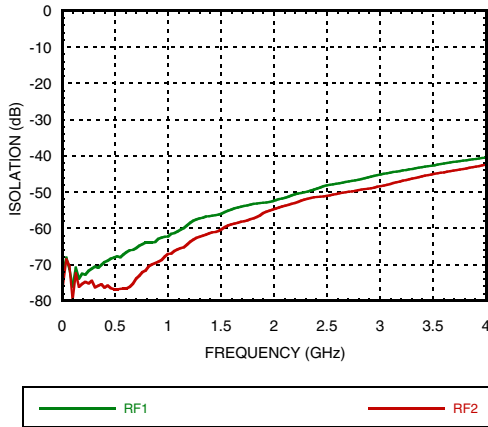

Isolation Between Ports RF1 and RF2

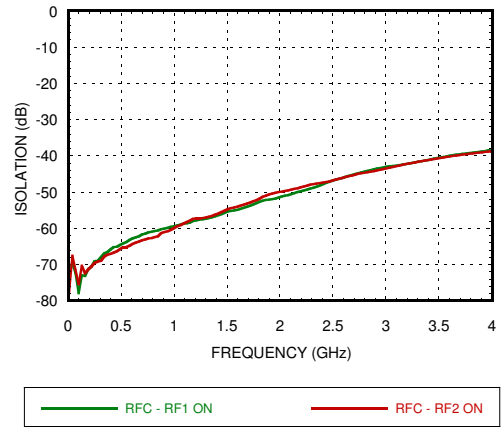

0.1 and 1 dB Input Compression Point

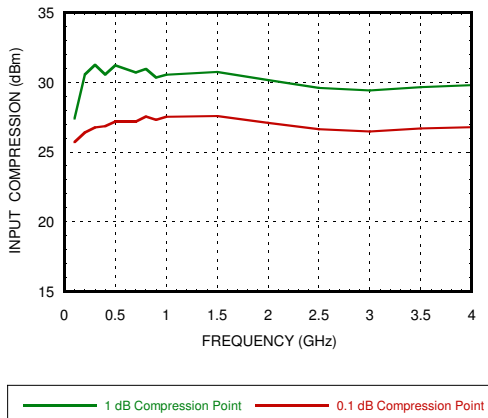

Input Third Order Intercept Point

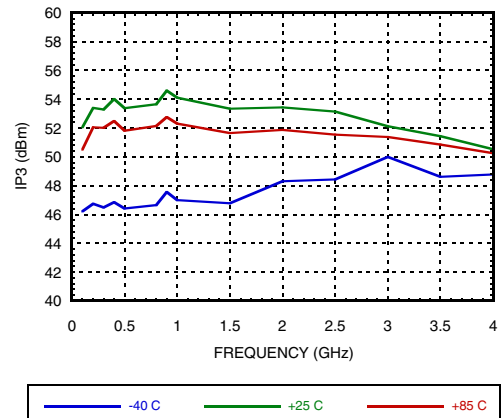



SPDT NON-REFLECTIVE SWITCH, DC - 4 GHz

Absolute Maximum Ratings

Control Voltage Range	-0.5 to +7.5 Vdc
RF Input Power $V_{ctl} = 0/+5V$	+31 dBm
RF1, RF2 Termination	+26 dBm
Junction Temperature	150 °C
Insertion Loss Path - (channel to ground) Continuous P_{diss} (T = 85 °C) (derate 13 mW/°C above 85 °C)	0.86 W
Thermal Resistance	75 °C/W
Termination Path - (channel to ground) Continuous P_{diss} (T = 85 °C) (derate 6.5 mW/°C above 85 °C)	0.42 W
Thermal Resistance	153 °C/W
Storage Temperature	-65 to +150 °C
Operating Temperature	-40 to +85 °C
ESD Sensitivity (HBM)	Class 1A

Control Voltages

*Control Input Tolerances are ± 0.2 Vdc

State	Bias Condition*
Low	0 Vdc @ 5 μ A Typical
High	+5.0 Vdc @ 5 μ A Typical

Truth Table

Control Input		Signal Path State
A	B	RFC to:
Low	High	RF1
High	Low	RF2

DC blocks are required at ports RFC, RF1, RF2.

Do not operate continuously at RF power input greater than 1 dB compression and do not "Hot Switch" power levels greater than +24 dBm (control = 0/+5 Vdc).



ELECTROSTATIC SENSITIVE DEVICE
OBSERVE HANDLING PRECAUTIONS

Outline Drawing

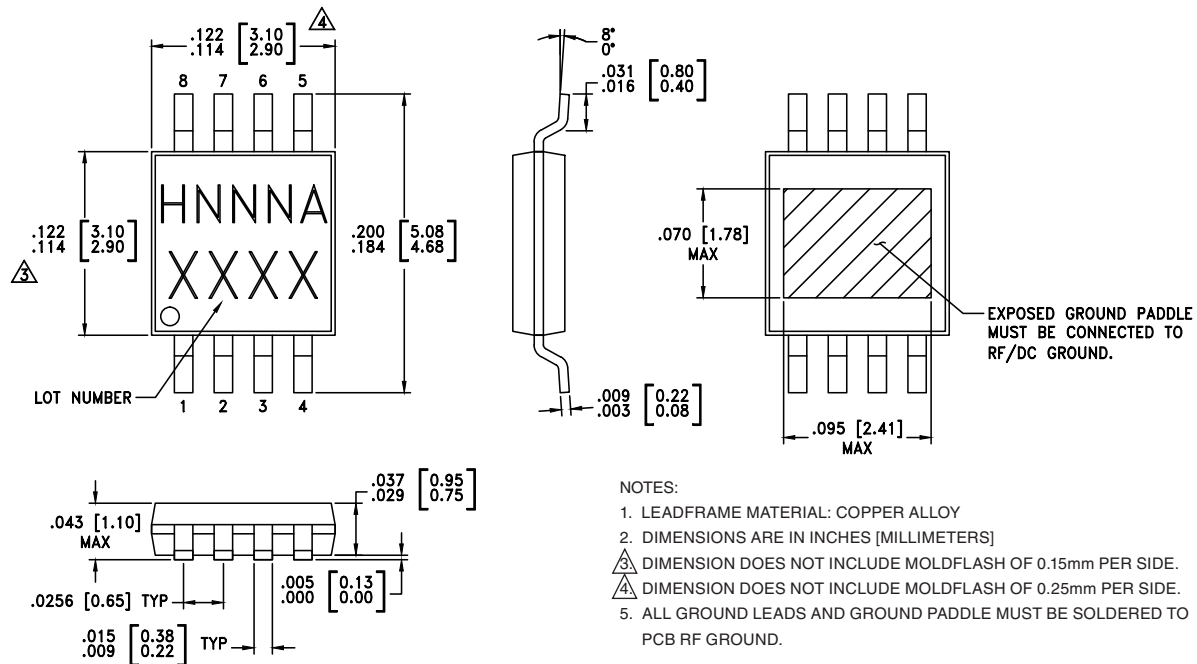



SPDT NON-REFLECTIVE SWITCH, DC - 4 GHz

Package Information



Part Number	Package Body Material	Lead Finish	MSL Rating	Package Marking ^[3]
HMC435AMS8G	Low Stress Injection Molded Plastic	Sn/Pb Solder	MSL3 ^[1]	H435A XXXX
HMC435AMS8GE	RoHS-compliant Low Stress Injection Molded Plastic	100% matte Sn	MSL3 ^[2]	H435A XXXX

[1] Max peak reflow temperature of 235 °C

[2] Max peak reflow temperature of 260 °C

[3] 4-Digit lot number XXXX

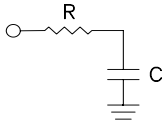
Pin Descriptions

Pin Number	Function	Description	Interface Schematic
1	A	See truth and control voltage tables.	
2	B	See truth and control voltage tables.	
3, 5, 8	RFC, RF1, RF2	These pins are DC coupled and matched to 50 Ohms. Blocking capacitors are required.	
4	N/C	This pin is not connected internally; however, all data shown herein was measured with this pin connected to RF/DC ground externally.	
6, 7	GND	Package bottom has exposed metal paddle that must be connected to PCB RF ground as well.	



**SPDT NON-REFLECTIVE
SWITCH, DC - 4 GHz**

Evaluation PCB

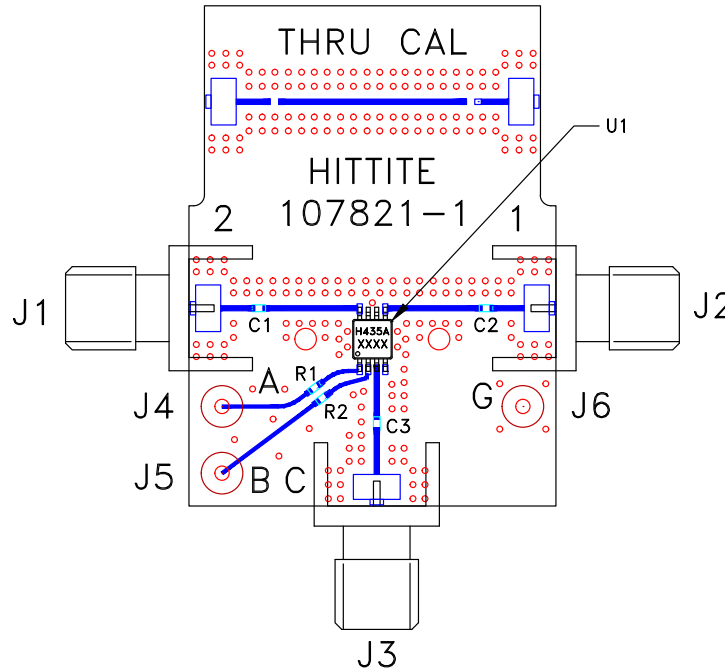

List of Materials for Evaluation PCB EVAL 105143-HMC435AMS8G^[1]

Item	Description
J1 - J3	PCB Mount SMA RF Connector
J4 - J6	DC Pin
C1 - C3	100 pF Capacitor, 0402 Pkg.
R1 - R2	100 Ohm Resistor, 0402 Pkg.
U1	HMC435AMS8G(E) SPDT Switch
PCB [2]	107821 Evaluation PCB

[1] Reference this number when ordering complete evaluation PCB

[2] Circuit Board Material: Rogers 4350

The circuit board used in the application should be generated with proper RF circuit design techniques. Signal lines at the RF port should have 50 Ohm impedance and the package ground leads and backside ground slug should be connected directly to the ground plane similar to that shown above. The evaluation circuit board shown above is available from Analog Devices, upon request.

Looking for pricing, stock, or lifecycle information?

Click below to explore more details on WIN SOURCE:

 [View HMC435AMS8GE on WIN SOURCE](#)

 [Analog Devices Inc. Information](#)

Optimize Your Supply Chain with WIN SOURCE Solutions

-  Global Sourcing Solution
-  Obsolete Management
-  Cost Control Management
-  Shortage Management
-  Alternative Solution
-  Excess Inventory Management