



# THE DATASHEET OF HMA2701AR2



**HMA121 Series**

**HMA124**

**HMA2701 Series**

**HMAA2705**

**DESCRIPTION**

The HMA124, HMA121 series and HMA2701 series consists of a gallium arsenide infrared emitting diode driving a silicon phototransistor in a compact 4-pin mini-flat package. The lead pitch is 2.54 mm.

The HMAA2705 consists of two gallium arsenide infrared emitting diodes, connected in inverse parallel, driving a single silicon phototransistor in a compact 4-pin mini-flat package. The lead pitch is 2.54mm.

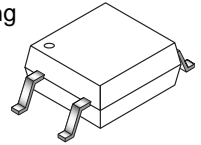

**FEATURES**

- Compact 4-pin package (2.4 mm maximum standoff height)
- Current Transfer Ratio in selected groups
 

HMA121: 50–600%	HMA2701: 50–300%
HMA121A: 100–300%	HMA2701A: 150–300%
HMA121B: 50–150%	HMA2701B: 80–160%
HMA121C: 100–200%	HMA124: 100% MIN
HMA121D: 50–100%	HMAA2705: 50–300%
HMA121E: 150–300%	
HMA121F: 100–600%	
- Available in tape and reel quantities of 500 and 2500.
- Applicable to Infrared Ray reflow (230°C max, 30 seconds.)
- BSI (File #8611/8612), CSA (File #1162301), UL (File #E90700) and VDE (File #136480) certified
- Creepage ≥ 5 mm, typical 5.2 mm
- Clearance ≥ 5 mm, typical 5.2 mm

**APPLICATIONS**

**HMAA2705**

- AC line monitor
- Unknown polarity DC sensor
- Telephone line receiver

**HMA121 series, HMA2701 series, HMA124**

- Digital logic inputs
- Microprocessor inputs
- Power supply monitor
- Twisted pair line receiver
- Telephone line receiver

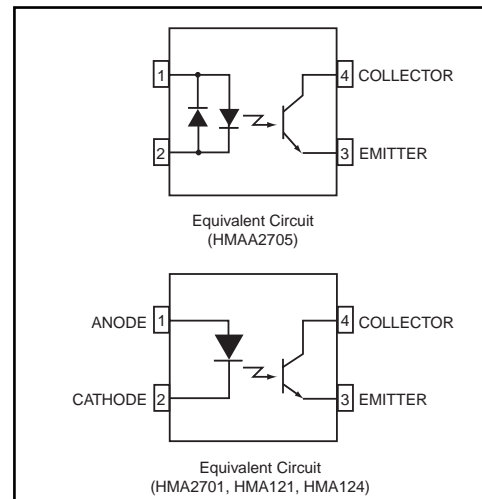
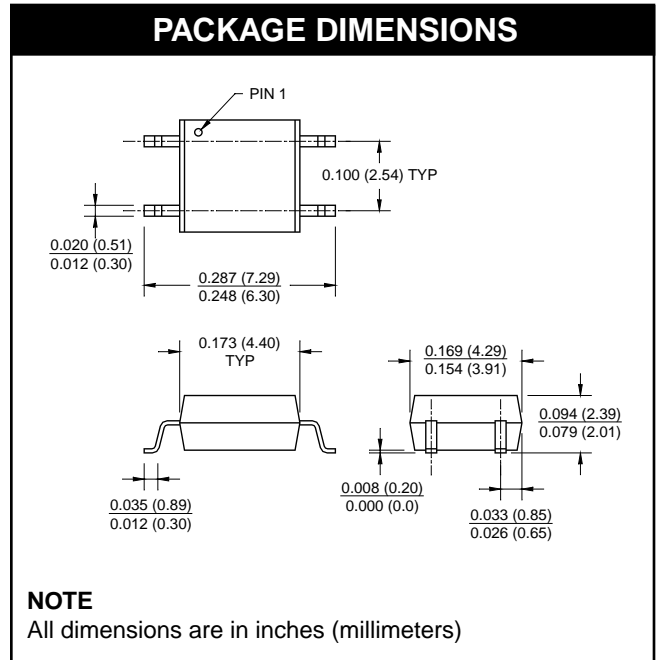

**HMA121 Series**

**HMA124**

**HMA2701 Series**

**HMAA2705**

<b>ABSOLUTE MAXIMUM RATINGS</b> ( $T_A = 25^\circ\text{C}$ unless otherwise specified)			
<b>Parameter</b>	<b>Symbol</b>	<b>Value</b>	<b>Units</b>
<b>TOTAL PACKAGE</b>			
Storage Temperature	$T_{\text{STG}}$	-40 to +125	$^\circ\text{C}$
Operating Temperature	$T_{\text{OPR}}$	-40 to +100	$^\circ\text{C}$
<b>EMITTER</b>			
Continuous Forward Current	$I_{\text{F (avg)}}$	50	mA
Peak Forward Current (1 $\mu\text{s}$ pulse, 300 pps.)	$I_{\text{F (pk)}}$	1	A
Reverse Input Voltage (HMA)	$V_{\text{R}}$	6	V
Power Dissipation	$P_{\text{D}}$	70	mW
Derate linearly (above $25^\circ\text{C}$ )		0.65	mW/ $^\circ\text{C}$
<b>DETECTOR</b>			
Continuous Collector Current		80	mA
Power Dissipation	$P_{\text{D}}$	150	mW
Derate linearly (above $25^\circ\text{C}$ )		2.0	mW/ $^\circ\text{C}$
Collector-Emitter Voltage	$V_{\text{CEO}}$	HMA2701 Series, HMAA2705 40	V
		HMA121 Series, HMA124 80	
Emitter-Collector Voltage	$V_{\text{ECO}}$	7	V

**HMA121 Series**

**HMA124**

**HMA2701 Series**

**HMAA2705**

**ELECTRICAL CHARACTERISTICS** ( $T_A = 25^\circ\text{C}$ )

**INDIVIDUAL COMPONENT CHARACTERISTICS**

Parameter	Test Conditions	Symbol	Device	Min	Typ**	Max	Unit
<b>EMITTER</b> Forward Voltage	$(I_F = 10 \text{ mA})$	$V_F$	HMA121 Series	1.0		1.3	V
			HMA124				
	$(I_F = 5 \text{ mA})$		HMA2701 Series			1.4	
			HMAA2705				
Reverse Current	$(V_R = 5 \text{ V})$	$I_R$	HMA2701 Series			5	$\mu\text{A}$
			HMA121 Series				
			HMA124				
<b>DETECTOR</b> Breakdown Voltage Collector to Emitter	$(I_C = 1 \text{ mA}, I_F = 0)$	$BV_{CEO}$	HMA121 Series	80			V
			HMA124				
			HMA2701 Series	40			
			HMAA2705				
Emitter to Collector	$(I_E = 100 \mu\text{A}, I_F = 0)$	$BV_{ECO}$	All	7			
Collector Dark Current	$(V_{CE} = 40 \text{ V}, I_F = 0)$	$I_{CEO}$	All			100	nA
Capacitance	$(V_{CE} = 0 \text{ V}, f = 1 \text{ MHz})$	$C_{CE}$	All		10		pF

**HMA121 Series**

**HMA124**

**HMA2701 Series**

**HMAA2705**

<b>TRANSFER CHARACTERISTICS</b> ( $T_A = 25^\circ\text{C}$ )							
Characteristic	Test Conditions	Symbol	Device	Min	Typ**	Max	Unit
DC Current Transfer Ratio	$(I_F = \pm 5 \text{ mA}, V_{CE} = 5 \text{ V})$	CTR	HMAA2705	50		300	%
			HMA2701	50		300	
	$(I_F = 5 \text{ mA}, V_{CE} = 5 \text{ V})$		HMA2701A	150		300	
			HMA2701B	80		160	
	$(I_F = 5 \text{ mA}, V_{CE} = 5 \text{ V})$		HMA121	50		600	
			HMA121A	100		300	
			HMA121B	50		150	
			HMA121C	100		200	
			HMA121D	50		100	
			HMA121E	150		300	
			HMA121F	100		600	
$(I_F = 1 \text{ mA}, V_{CE} = 0.4 \text{ V})$	HMA121F	30					
$(I_F = 1 \text{ mA}, V_{CE} = 0.5 \text{ V})$	HMA124	100		1200			
$(I_F = 0.5 \text{ mA}, V_{CE} = 1.5 \text{ V})$	HMA124	50		—			
CTR Symmetry	$(I_F = \pm 5 \text{ mA}, V_{CE} = 5 \text{ V})$	—	HMAA2705	0.3		3.0	
Saturation Voltage	$(I_F = \pm 10 \text{ mA}, I_C = 2 \text{ mA})$	$V_{CE(SAT)}$	HMAA2705			0.3	V
			HMA2701			0.3	
	$(I_F = 10 \text{ mA}, I_C = 2 \text{ mA})$		HMA2701A			0.3	
			HMA2701B			0.3	
	$(I_F = 8 \text{ mA}, I_C = 2.4 \text{ mA})$		HMA121			0.4	
			HMA121A			0.4	
			HMA121B			0.4	
			HMA121C			0.4	
			HMA121D			0.4	
			HMA121E			0.4	
			HMA121F			0.4	
$(I_F = 1 \text{ mA}, I_C = 0.2 \text{ mA})$	HMA121F			0.4			
$(I_F = 1 \text{ mA}, I_C = 0.5 \text{ mA})$	HMA124			0.4			
Rise Time (Non-Saturated)	$(I_C = 2 \text{ mA}, V_{CE} = 5 \text{ V})$ $(R_L = 100\Omega)$	$t_r$			3		$\mu\text{s}$
Fall Time (Non-Saturated)	$(I_C = 2 \text{ mA}, V_{CE} = 5 \text{ V})$ $(R_L = 100\Omega)$	$t_f$			3		

**ISOLATION CHARACTERISTICS**

Characteristic	Test Conditions	Symbol	Device	Min	Typ**	Max	Unit
Steady State Isolation Voltage	(1 Minute)	$V_{ISO}$	All	3750			VRMS

\*\* All typicals at  $T_A = 25^\circ\text{C}$

**TYPICAL PERFORMANCE CURVES**

**Fig. 1 Forward Current vs. Forward Voltage**



**Fig. 2 Collector Current vs. Forward Current**



**Fig. 3 Current Transfer Ratio vs. Forward Current**



**Fig. 4 Collector Current vs. Temperature**

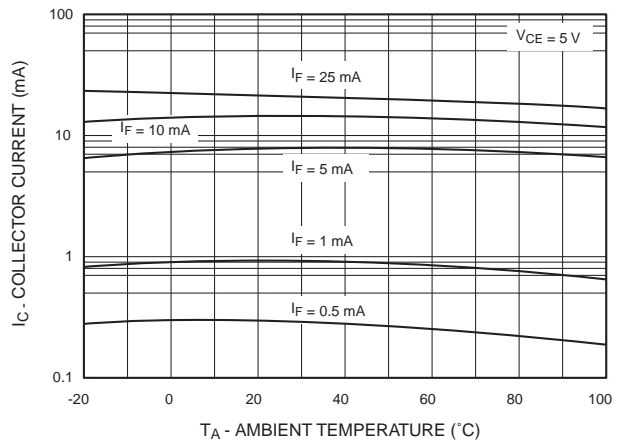

**Fig. 5 Collector Current vs. Collector-Emitter Voltage**

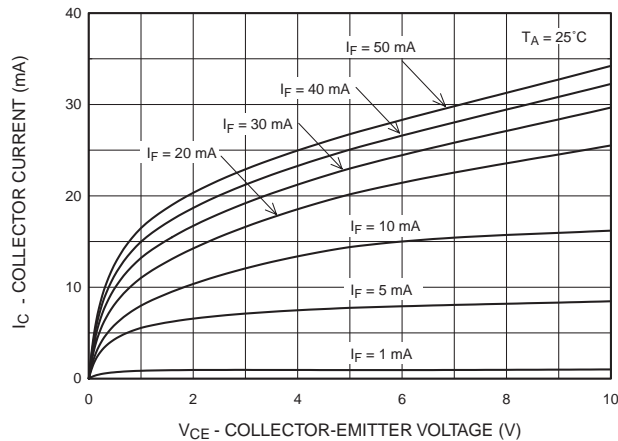

**HMA121 Series**

**HMA124**

**HMA2701 Series**

**HMAA2705**

**Fig. 6 Collector Current vs. Collector-Emitter Voltage**



**Fig. 7 Collector Dark Current vs. Temperature**



**Fig. 8 Switching Time vs. Load Resistance**

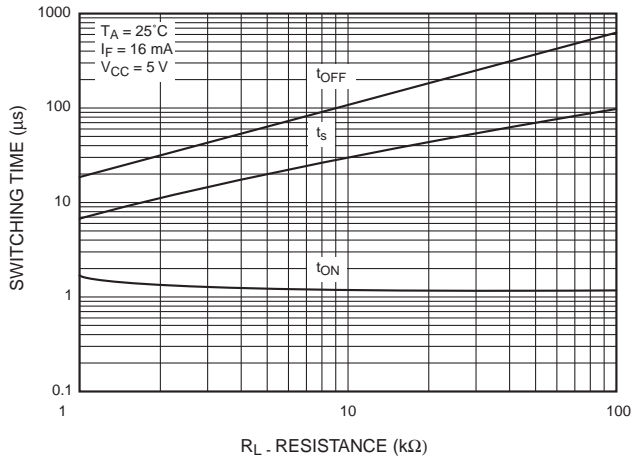

**Fig. 9 Collector-Emitter Saturation Voltage vs. Temperature**

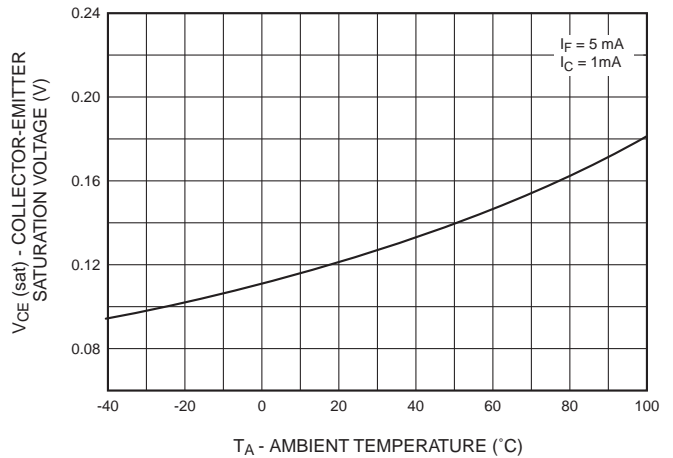

**HMA121 Series**

**HMA124**

**HMA2701 Series**

**HMAA2705**

**ORDERING INFORMATION**

Option	Description
V	VDE Approved
R1	Tape and Reel (500 units)
R2	Tape and Reel (2500 units)
R3	Tape and Reel (500 units; unit 180° rotated)
R4	Tape and Reel (2500 units; unit 180° rotated)
R1V	Tape and Reel (500 units) and VDE Approved
R2V	Tape and Reel (2500 units) and VDE Approved
R3V	Tape and Reel (500 units; unit 180° rotated) and VDE Approved
R4V	Tape and Reel (2500 units; unit 180° rotated) and VDE Approved

**MARKING INFORMATION**

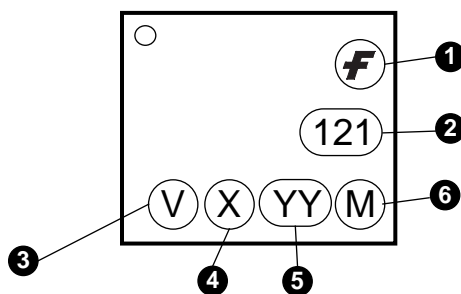

Definitions	
1	Fairchild logo
2	Device number
3	VDE mark (Note: Only appears on parts ordered with VDE option – See order entry table)
4	One digit year code
5	Two digit work week ranging from '01' to '53'
6	Assembly package code

**HMA121 Series**

**HMA124**

**HMA2701 Series**

**HMAA2705**



Description		Symbol	2.54 Pitch Dimensions (mm)
Tape Width		W	12.00±0.4
Tape Thickness		t	0.30±0.20
Sprocket Hole Pitch		P <sub>0</sub>	4.00±0.20
Sprocket Hole Dia.		D <sub>0</sub>	1.55±0.20
Sprocket Hole Location		E	1.75±0.20
Pocket Location		F	5.50±0.20
		P <sub>2</sub>	2.00±0.20
Pocket Pitch		P	8.00±0.20
Pocket Dimension		A <sub>0</sub>	4.40±0.20
		B <sub>0</sub>	7.30±0.20
		K <sub>0</sub>	2.30±0.20
Pocket Hole Dia.		D <sub>1</sub>	1.55±0.20
Cover Tape Width		W <sub>1</sub>	9.20
Cover Tape Thickness		d	0.065±0.02
Max. Component Rotation or Tilt			20° max
Devices Per Reel	R1		500
	R2		2500
Reel Diameter	R1		178 mm (7")
	R2		330 mm (13")

**HMA121 Series**

**HMA124**

**HMA2701 Series**

**HMAA2705**

**Footprint Drawing for PCB Layout**



**Recommended Infrared Reflow Soldering Profile**



- Peak reflow temperature: 230°C (package surface temperature) for 30 seconds
- Time of temperature higher than 210°C: 60 seconds or less
- One time soldering reflow is recommended

---

**HMA121 Series**

**HMA124**

**HMA2701 Series**

**HMAA2705**

---

**DISCLAIMER**

FAIRCHILD SEMICONDUCTOR RESERVES THE RIGHT TO MAKE CHANGES WITHOUT FURTHER NOTICE TO ANY PRODUCTS HEREIN TO IMPROVE RELIABILITY, FUNCTION OR DESIGN. FAIRCHILD DOES NOT ASSUME ANY LIABILITY ARISING OUT OF THE APPLICATION OR USE OF ANY PRODUCT OR CIRCUIT DESCRIBED HEREIN; NEITHER DOES IT CONVEY ANY LICENSE UNDER ITS PATENT RIGHTS, NOR THE RIGHTS OF OTHERS.

**LIFE SUPPORT POLICY**

FAIRCHILD'S PRODUCTS ARE NOT AUTHORIZED FOR USE AS CRITICAL COMPONENTS IN LIFE SUPPORT DEVICES OR SYSTEMS WITHOUT THE EXPRESS WRITTEN APPROVAL OF THE PRESIDENT OF FAIRCHILD SEMICONDUCTOR CORPORATION. As used herein:

1. Life support devices or systems are devices or systems which, (a) are intended for surgical implant into the body, or (b) support or sustain life, and (c) whose failure to perform when properly used in accordance with instructions for use provided in the labeling, can be reasonably expected to result in a significant injury of the user.
2. A critical component in any component of a life support device or system whose failure to perform can be reasonably expected to cause the failure of the life support device or system, or to affect its safety or effectiveness.

## Looking for pricing, stock, or lifecycle information?

Click below to explore more details on WIN SOURCE:

- ⊖ [View HMA2701AR2](#) on WIN SOURCE
- ⊖ [ON Semiconductor](#) Information

## Optimize Your Supply Chain with WIN SOURCE Solutions

- ✓ Global Sourcing Solution
- ✓ Obsolete Management
- ✓ Cost Control Management
- ✓ Shortage Management
- ✓ Alternative Solution
- ✓ Excess Inventory Management