



# THE DATASHEET OF HFCN-1200D+





CERAMIC

# High Pass Filter

## HFCN-1200D+

Mini-Circuits

50Ω 1220 to 4600 MHz

### THE BIG DEAL

- Low cost
- Small size
- 7 sections
- Temperature stable
- LTCC construction
- Excellent power handling, 7W
- Hermetically sealed

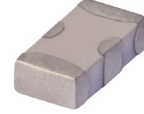

Generic photo used for illustration purposes only

CASE STYLE: FV1206

### +RoHS Compliant

The +Suffix identifies RoHS Compliance. See our web site for RoHS Compliance methodologies and qualifications

### APPLICATIONS

- Sub-harmonic rejection
- Transmitters/receivers
- Lab use

### ELECTRICAL SPECIFICATIONS<sup>1,2</sup> AT 25°C

Parameter	Frequency (MHz)	Min.	Typ.	Max.	Units	
Stop Band	Rejection Loss	750	40	—	—	dB
		910	20	—	—	
	Freq. Cut-Off	1180	—	3.0	—	
	VSWR	750-910	—	20	—	
Pass Band	Insertion Loss	1220-4600	—	2.0	—	dB
		1380-4000	—	—	1.3	dB
	VSWR	1300-3200	—	1.5	—	:1

1. DC Resistance to ground is 100 Mohms min.

2. Measured on Mini-Circuits Characterization Test Board TB-270.

### MAXIMUM RATINGS

Parameter	Ratings
Operating temperature	-55°C to +100°C
Storage temperature	-55°C to +100°C
RF Power Input <sup>3</sup>	7W max.at 25°C

3. Passband rating, derate linearly to 3W at 100°C ambient.

Permanent damage may occur if any of these limits are exceeded.

### TYPICAL FREQUENCY RESPONSE

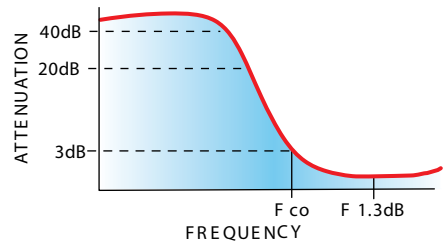

### FUNCTIONAL SCHEMATIC

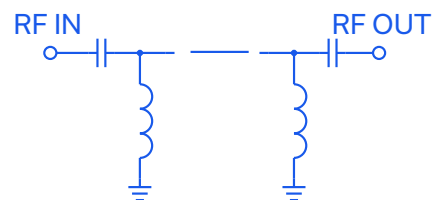

REV. C  
ECO-011980  
HFCN-1200D+  
AD/CP/AM  
220221



### PIN CONNECTIONS

RF IN	1
RF OUT	3
GROUND	2,4

PRODUCT MARKING: N/A

DEMO BOARD MCL P/N: TB-270  
SUGGESTED PCB LAYOUT (PL-137)

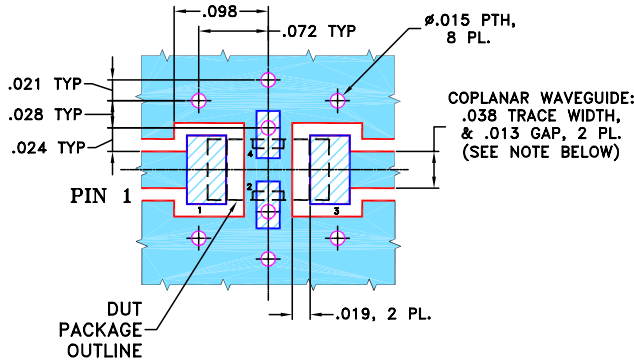

- NOTES:**
1. COPLANAR WAVEGUIDE PARAMETERS ARE SHOWN FOR ROGERS RO4350B WITH THICKNESS .020" ± .0015". COPPER: 1/2 OZ. EACH SIDE. FOR OTHER MATERIALS TRACE WIDTH & GAP MAY NEED TO BE MODIFIED.
  2. BOTTOM SIDE OF THE PCB IS CONTINUOUS GROUND PLANE.

- DENOTES PCB COPPER LAYOUT WITH SMOBC (SOLDER MASK OVER BARE COPPER)
- DENOTES COPPER LAND PATTERN FREE OF SOLDER MASK

### OUTLINE DRAWING

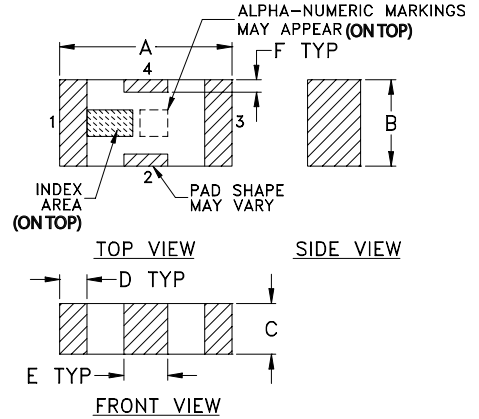

### PCB Land Pattern

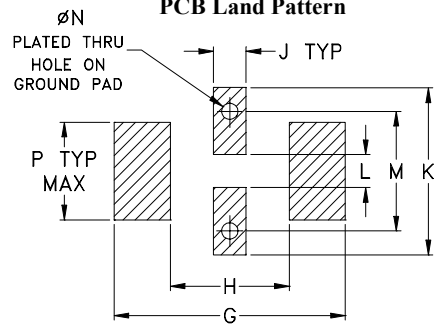

Suggested Layout,  
Tolerance to be within ±.002

### OUTLINE DIMENSIONS (Inches mm)

A	B	C	D	E	F	G	
.126	.063	.037	.020	.032	.009	.169	
3.20	1.60	0.94	0.51	0.81	0.23	4.29	
H	J	K	L	M	N	P	wt
.087	.024	.122	.024	.087	.012	.071	grams
2.21	0.61	3.10	0.61	2.21	0.30	1.80	.020

TAPE & REEL INFORMATION: F71



CERAMIC

# High Pass Filter

## HFCN-1200D+

### TYPICAL PERFORMANCE DATA AT 25°C

Frequency (MHz)	Insertion Loss (dB)	VSWR (:1)
1.00	104.60	1737.18
100.00	76.44	1737.18
750.00	63.39	56.04
910.00	30.29	32.79
1050.00	13.74	12.35
1130.00	6.09	4.53
1180.00	3.15	2.35
1220.00	2.01	1.65
1300.00	1.24	1.39
1380.00	0.98	1.39
3200.00	0.44	1.33
4000.00	0.93	2.01
4600.00	1.62	2.73
7000.00	4.86	6.63

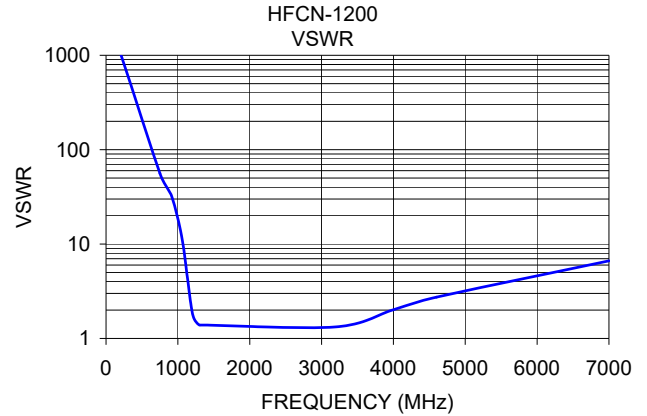
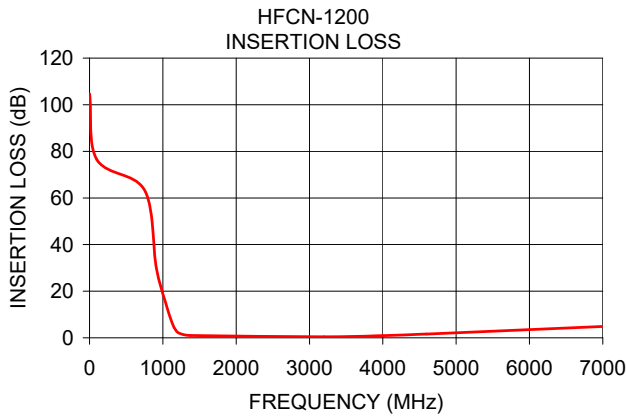

#### NOTES

- A. Performance and quality attributes and conditions not expressly stated in this specification document are intended to be excluded and do not form a part of this specification document.
- B. Electrical specifications and performance data contained in this specification document are based on Mini-Circuit's applicable established test performance criteria and measurement instructions.
- C. The parts covered by this specification document are subject to Mini-Circuits standard limited warranty and terms and conditions (collectively, "Standard Terms"); Purchasers of this part are entitled to the rights and benefits contained therein. For a full statement of the standard. Terms and the exclusive rights and remedies thereunder, please visit Mini-Circuits' website at [www.minicircuits.com/MCLStore/terms.jsp](http://www.minicircuits.com/MCLStore/terms.jsp)



## Looking for pricing, stock, or lifecycle information?

Click below to explore more details on WIN SOURCE:

 [View HFCN-1200D+ on WIN SOURCE](#)

 [Mini-Circuits Information](#)

## Optimize Your Supply Chain with WIN SOURCE Solutions

-  Global Sourcing Solution
-  Obsolete Management
-  Cost Control Management
-  Shortage Management
-  Alternative Solution
-  Excess Inventory Management