



THE DATASHEET OF H2052DG





Product Specification for Approval

WE ARE PLEASED IN SUBMITTING OUR SAMPLES WITH SPECIFICATION TO YOU FOR APPROVAL.

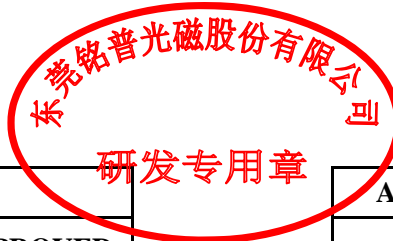
CUSTOMER	:	
DESCRIPTION	:	10/100 BASE-T TRANSFORMER
MNC P/N	:	H2052DG
VERSION	:	A0
CUSTOMER P/N	:	
ISSUED DATE	:	2020/04/27
PHOTO OF PRODUCT	:	
WEIGHT	:	1.79g
MADE IN	:	CHINA



APPROVED BY MNC			APPROVED BY CUSTOMER
PREPARED BY  研发部 2020-04-27 符晶晶	CHECKED BY  研发部 2020-04-27 肖明华	APPROVED BY  研发部 2020-04-27 何校民	SIGNATURE OR STAMP

1. PLEASE SEND BACK US A COPY OF THE SPECIFICATION WITH YOUR STAMP OR SIGNATURE ONCE THE SAMPLES APPROVED.
2. IT WILL BE DEEMED THE SAMPLES TO BE APPROVED IF NO FEEDBACK.

东莞铭普光磁股份有限公司
 Add: Shipai Town, Dongguan City, Guangdong Province, China

TEL: +86-769-86921000
 FAX: +86-769-81701563

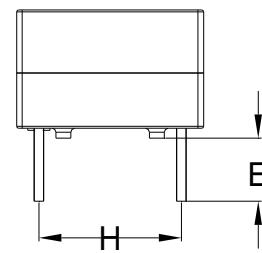
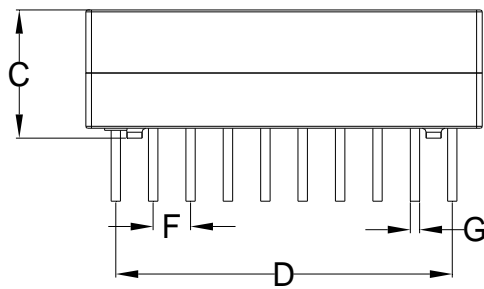
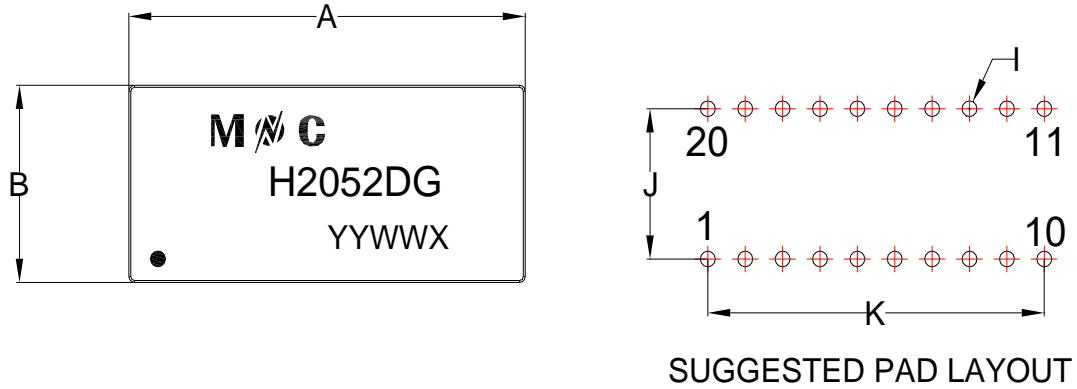
SPECIFICATION
Part No. H2052DG
A. MECHANICAL :

Note: White ink marking

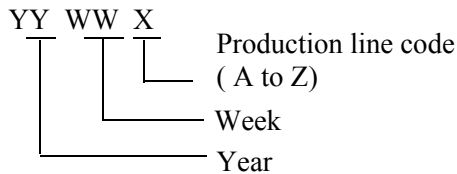

1. UNITS:mm/inch.
2. UNLESS OTHERWISE SPECIFIED ALL TOLERANCES ARE: TYPICAL
3. PIN LENGTH DON'T INCLUDE SOLDER POINT

DIM	MILLIMETERS			INCHES		
	MIN	NOM	MAX	MIN	NOM	MAX
A	20.70	21.20	21.70	0.815	0.835	0.854
B	9.50	10.00	10.50	0.374	0.394	0.413
C	/	/	6.75	/	/	0.266
D	17.50	18.00	18.50	0.689	0.709	0.728
E	2.90	3.20	3.50	0.114	0.126	0.138
F	1.85	2.00	2.15	0.073	0.079	0.085
G	0.40	0.50	0.60	0.016	0.020	0.024
H	7.12	7.62	8.12	0.280	0.300	0.320
I	/	0.80	/	/	0.031	/
J	/	7.62	/	/	0.300	/
K	/	18.00	/	/	0.709	/

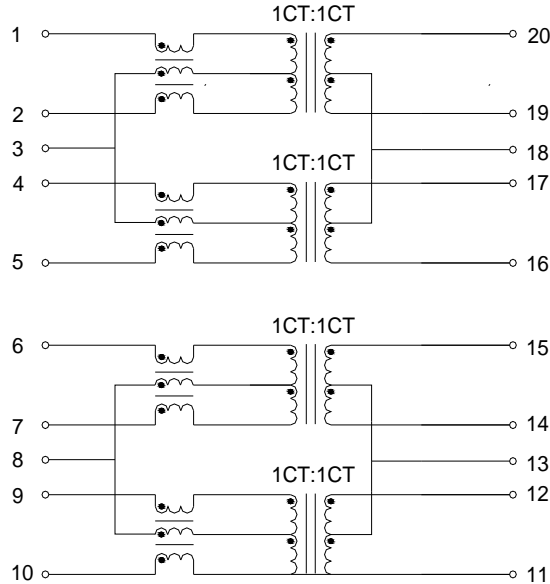
SPECIFICATION
Part No. H2052DG
B. SCHEMATIC :

C. ELECTRICAL SPECIFICATION @25°C

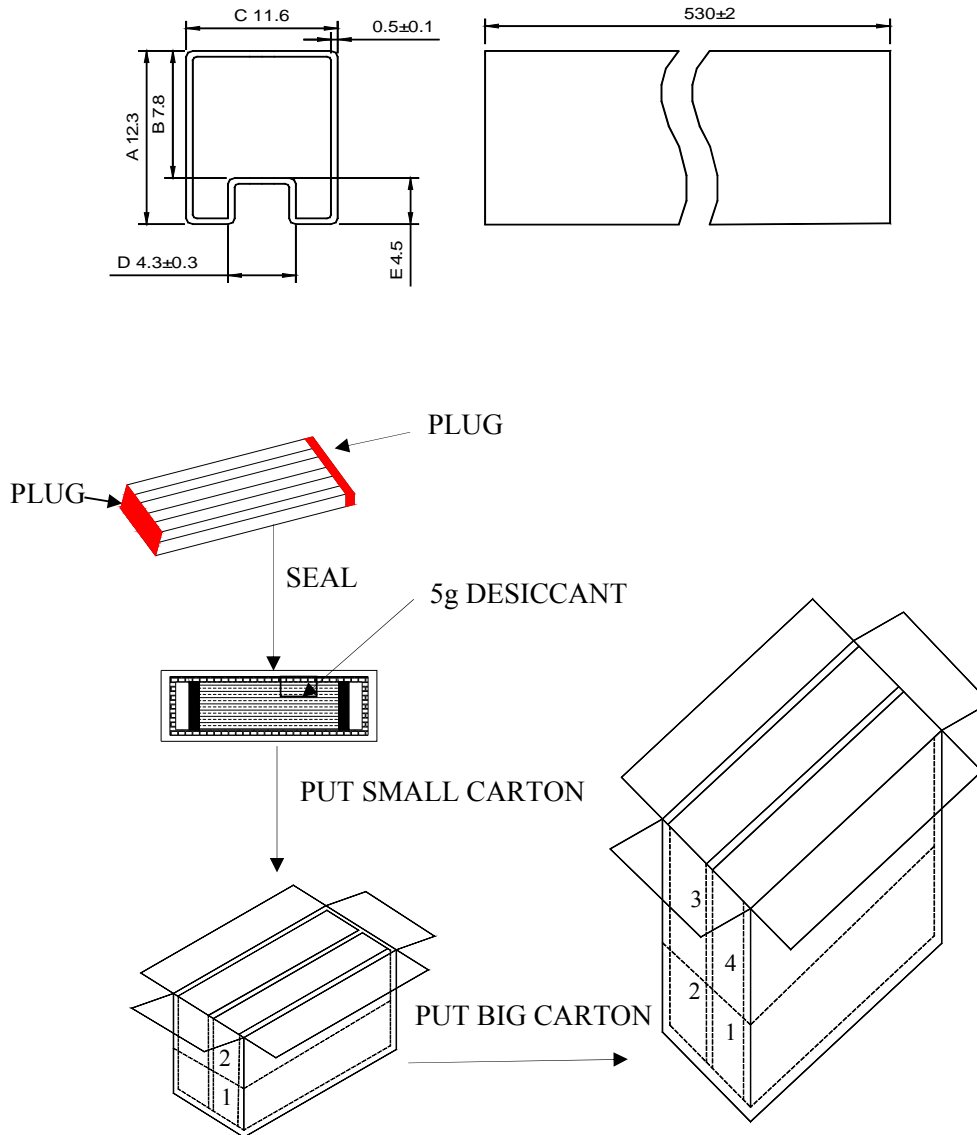
ITEM	SPECIFICATION	TEST CONDITION	TEST EQUIPMENT
INDUCTANCE :	350uH MIN.	100KHz 0.2V 8mA DC Bias	TH2819XB OR EQU.
LEAKAGE INDUCTANCE :	0.50uH MAX.	100KHz 0.2V	TH2819XB OR EQU.
INTERWINDING CAPACITANCE :	50pF TYP.	100KHz 0.2V	TH2819XB OR EQU.
DC RESISTANCE :	1.4Ω MAX.	AT 25 °C	TH2819XB OR EQU.
TURNS RATIO :	1CT:1CT±5%		TH2819XB OR EQU.
POLARITY :	1-20,4-17,6-15,9-12 IN-PHASE		
INSERTION LOSS :	-1.1dB MAX.	0.5-100 MHz	E5061A OR EQU.
RETURN LOSS :	-18dB MIN.	0.5-30 MHz	E5061A OR EQU.
	-18+20*log(f/30)dB MIN.	30.1-60MHz	
	-12dB MIN.	60.1-80MHz	
CROSS TALK :	-35dB MIN.	0.5-40 MHz	E5061A OR EQU.
	-33+20*log(f/50)dB MIN.	40.1-100 MHz	
CMRR :	-30dB MIN.	0.5-100 MHz	E5061A OR EQU.
ISOLATION HI-POT :PRI TO SEC	1500VAC	1mA,60S	7152AB OR EQU.
	1650VAC	1mA,6S	
OPERATING TEMPERATURE	0°C TO 70°C		

PACKAGE
Part No. H2052DG
D. PACKING:
a. PACKAGING AS BELOW (ONLY FOR A REFERENCE):

b. Q'TY:

24 PCS PER TUBE
 5 TUBES PER BUNDLE (120 PCS)
 10 BUNDLES PER BAG (1200 PCS)
 1 BAG PER SMALL CARTON
 4 SMALL CARTON PER BIG CARTON(4800 PCS)

c. LABEL:

REMARK:

ABOVE PACKING IS FOR YOUR REFERENCE ONLY, WHICH MIGHT BE CHANGED WITHOUT NOTICE.

MATERIAL LIST
Part No. H2052DG
E.BOM

MATERIAL LIST					
NO.	ITEM	MATERIAL	RATING	SUPPLIER OF MATERIAL	UL
1	CORE	Mn-Zn	-----	YEAN SHING	N/A
			-----	ZHONGSHAN CRC ELECTRONICS FACTORY	N/A
		Ni-Zn	-----	YEAN SHING	N/A
			-----	ZHONGSHAN CRC ELECTRONICS FACTORY	N/A
2	COPPER WIRE	QPN180	180℃	ZHUHAI SUNTEK WIRE CO.,LTD	E234867
		Polysol 180	180℃	ELEKTRISOLA(MALAYSIA) SDN.BHD.	E258243
3	CASE	PF2A5-151J(b)	V-0	CHANGSHU SOUTH-EAST PLASTIC CO.,LTD	E136137
		T378J	V-0	CHANG CHUN CHEMICAL(ZHANGZHOU) CO.,LTD.	E59481
4	PIN	CP WIRE	-----	HIFAM	N/A
5	EPOXY	3300A/B	-----	DONGGUAN EATTO ELECTRONIC MATERIAL CO.,LTD	E218090

RECOMMENDED SOLDERING PROFILE**Part No. H2052DG****a. RECOMMENDED WAVE SOLDERING PROFILE:****CONDITION:**

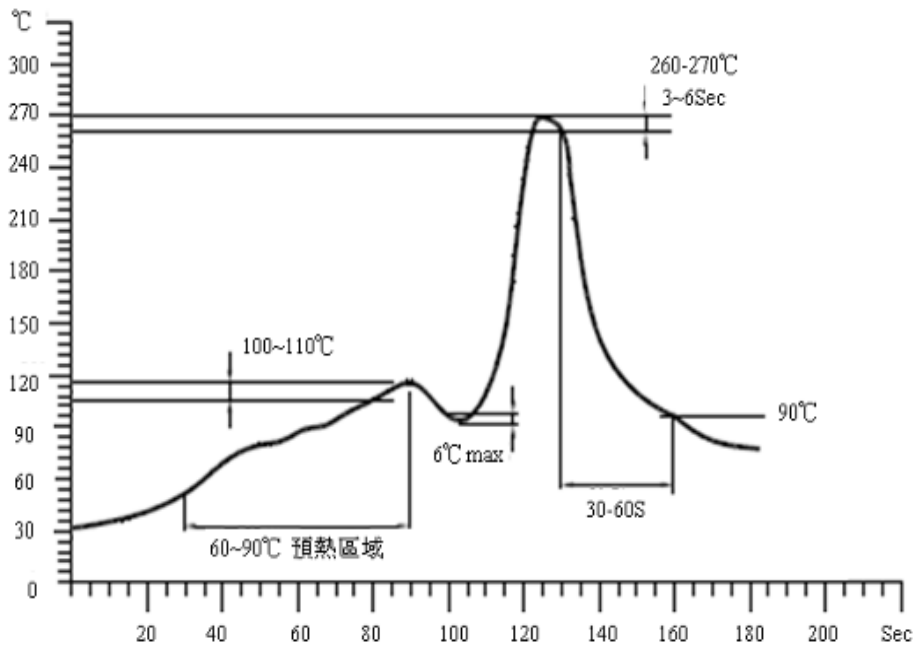

- a.1. AVAILABLE FOR ALL THE THROUGH HOLE PARTS
- a.2. SOLDERING METHOD: WAVE SOLDERING
- a.3. SOLDER: Sn-0.7Cu
- a.4. THE RECOMMENDED WAVE SOLDERING CURVE IS AS BELOW

**b. MOISTURE SENSITIVE LEVEL:**

- b.1. LEVEL: 1
- b.2. SHELF LIFE: UNLIMITED
- b.3. STORAGE CONDITION: $\leq 30^{\circ}\text{C}/85\% \text{RH}$

Looking for pricing, stock, or lifecycle information?

Click below to explore more details on WIN SOURCE:

-  [View H2052DG on WIN SOURCE](#)
-  [Mentech Technology USA Inc. Information](#)

Optimize Your Supply Chain with WIN SOURCE Solutions

-  Global Sourcing Solution
-  Obsolete Management
-  Cost Control Management
-  Shortage Management
-  Alternative Solution
-  Excess Inventory Management