



**THE DATASHEET OF
GVA-91+**





HIGH POWER, 1W

Monolithic Amplifier

GVA-91+

50Ω 869 - 2170 MHz

THE BIG DEAL

- High power, 29.5 dBm typ. at 920 MHz
- High gain, 20.4 dB typ.
- High power added efficiency
- High P1dB, 29.5 dBm at 920 MHz and 27.4 dBm at 2140 MHz.

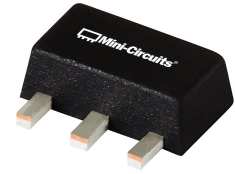

Generic photo used for illustration purposes only

CASE STYLE: DF782

+RoHS Compliant

The +Suffix identifies RoHS Compliance. See our web site for RoHS Compliance methodologies and qualifications

APPLICATIONS

- Base station infrastructure
- LTE
- WCDMA

PRODUCT OVERVIEW

Mini-Circuits GVA-91+ (RoHS compliant) is an advanced wideband amplifier fabricated using GaAs HBT technology, offering high gain and excellent power output with excellent power added efficiency in application bands. It has repeatable performance from lot to lot and is housed in an SOT-89 package for very good thermal performance.

KEY FEATURES

Feature	Advantages
Optimized over 869 – 960 MHz and 2110 – 2170 MHz	Matched for best power added efficiency in primary wireless communications bands: Cellular and LTE. Application Circuit with component values provided to minimize design effort at customer end.
High power output at P1dB: <ul style="list-style-type: none"> • 29 dBm over 869-960 MHz • 27 dBm over 2110-2170 MHz 	With a power added efficiency at 41-54%, GVA-91+ delivers high power with low DC power consumption.
High gain: <ul style="list-style-type: none"> • 20.4 dB typ. at 920 MHz • 15.9 dB typ. at 2140 MHz 	High gain results in fewer amplifier stages and cost savings.
Excellent ESD: <ul style="list-style-type: none"> • HBM: class 2 (2000 to <4000V) • MM: class M1 (50 to <100V) 	Built-in ESD protection for a robust product.

REV. B
ECO-010563
GVA-91+
TH/RS/CP
110921





HIGH POWER, 1W

Monolithic Amplifier

GVA-91+

Mini-Circuits

ELECTRICAL SPECIFICATIONS⁽¹⁾ AT 25°C AND VCC=5V, UNLESS NOTED

Parameter	Condition (MHz)	900 MHz Match			Condition (MHz)	2100 MHz Match			Units
		Min.	Typ.	Max.		Min.	Typ.	Max.	
Frequency Range		869		960		2110		2170	MHz
Gain	869		20.6		2110		16.3		dB
	920	18.6	20.4	22.7	2140	14.6	15.9	17.8	
	960		19.7		2170		15.4		
Input Return Loss	869		11.0		2110		14.2		dB
	920		10.9		2140		9.6		
	960		7.3		2170		6.9		
Output Return Loss	869		18.6		2110		11.1		dB
	920		16.9		2140		9.7		
	960		12.4		2170		8.3		
Reverse Isolation	869 - 920		34.5		2110 - 2170		29.9		dB
Output Power at 1dB Compression ²	869		29.5		2110		27.4		dBm
	920		28.8		2140		27.0		
	960		28.0		2170		26.7		
Output Power at 3dB Compression	869		30.6		2110		28.4		dBm
	920		29.7		2140		27.9		
	960		29.0		2170		27.5		
Output IP3	869		39.9		2110		41.3		dBm
	920		39.9		2140		42.2		
	960		39.8		2170		43.4		
Efficiency Power Added at P1dB (PAE)	869 - 920		47.2		2110 - 2170		45.2		%
Noise Figure	869		6.4		2110		4.2		dB
	920		6.4		2140		4.6		
	960		6.6		2170		4.5		
Device Operating Voltage (Vcc)		4.8	5.0	5.2		4.8	5.0	5.2	V
Device Operating Current ²			147	176			147	176	mA
Device Current Variation vs. Temperature ³			135				130		µA/°C
Device Current Variation vs. Voltage			0.067				0.066		mA/mW
Thermal Resistance, junction-to-ground lead			25.6				25.6		°C/W

(1) Measured on Mini-Circuits Characterization test board TB-753+ (900 MHz match) and TB-752+ (2100 MHz match). See Characterization Test Circuit (Fig. 1).

(2) Current with no RF or small signal, increases at P1dB to 335 mA typ at 920 MHz and 291 mA at 2140 MHz

(3) Current at 85°C – Current at -45°C)/130



HIGH POWER, 1W

Monolithic Amplifier

GVA-91+

MAXIMUM RATINGS⁴

Parameter	Ratings		
Operating Temperature (ground lead)	-40°C to 85°C		
Storage Temperature	-65°C to 150°C		
Power Dissipation	1.7 W		
Input Power (CW) ⁽¹⁾	900 MHz	Continuous 21 dBm	5 Minutes Max. 30 dBm
	2100 MHz	23 dBm	30 dBm
DC Voltage on Pin 3	6V		

(4) Permanent damage may occur if any of these limits are exceeded.
Electrical maximum ratings are not intended for continuous normal operation unless specified.

SIMPLIFIED SCHEMATIC AND PIN DESCRIPTION

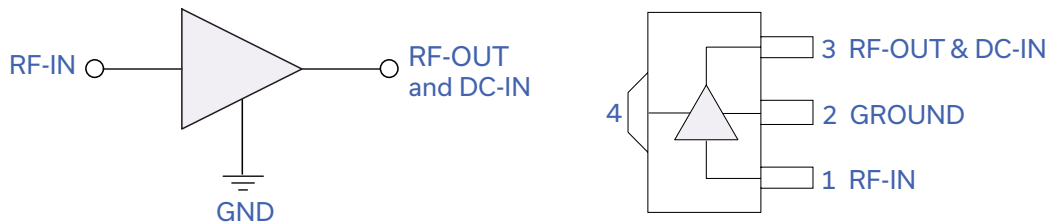

Function	Pin Number	Description
RF IN	1	RF input pin. This pin requires the use of an external DC blocking capacitor chosen for the frequency of operation.
RF-OUT and DC-IN	3	RF output and bias pin. DC voltage is present on this pin; therefore a DC blocking capacitor is necessary for proper operation. An RF choke is needed to feed DC bias without loss of RF signal due to the bias connection, as shown in "Recommended Application Circuit", Fig. 2
GND	2,4	Connections to ground. Use via holes as shown in "Suggested Layout for PCB Design" to reduce ground path inductance for best performance.



HIGH POWER, 1W

Monolithic Amplifier

GVA-91+

CHARACTERIZATION TEST AND APPLICATION CIRCUIT

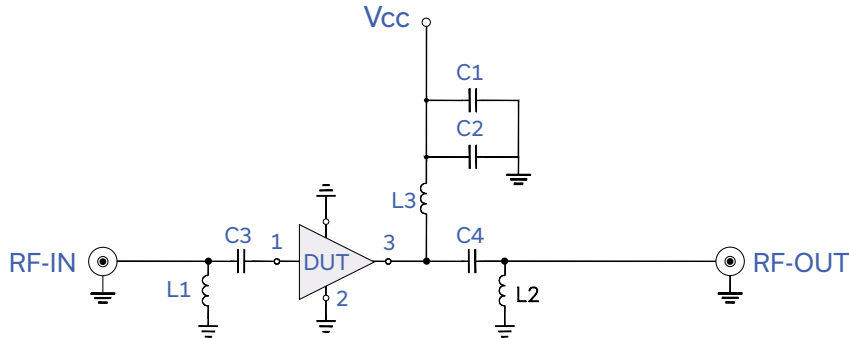

Component	TB-753+ 896-960 MHz		TB-752+ 2110-2170 MHz	
	Value	Size	Value	Size
DUT	GVA-91+	—	GVA-91+	—
C1	1.0 μ F	0402	1.0 μ F	0402
C2	100 pF		22 pF	
C3	8.2 pF		1.5 pF	
C4	6.2 pF		1.8 pF	
L1	2.7 nH		1.2 nH	
L2	5.6 nH	1.8 nH	1.8 nH	
L3	33 nH	18 nH		

Fig 1. Block Diagram of Test Circuit used for characterization. (DUT soldered on Mini-Circuits Characterization test board TB-753+(869-960 MHz) and TB-752+(2110-2170 MHz)

Gain, Return loss, Output power at 1dB compression (P1 dB) , output IP3 (OIP3) and noise figure measured using Agilent's N5242A PNA-X microwave network analyzer.

Conditions:

1. Gain and Return loss: Pin= -25dBm
2. Output IP3 (OIP3): Two tones, spaced 1 MHz apart, 20 dBm/tone at output.

PRODUCT MARKING

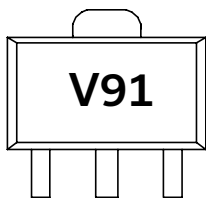

Marking may contain other features or characters for internal lot control



HIGH POWER, 1W

Monolithic Amplifier

GVA-91+

Mini-Circuits

ADDITIONAL DETAILED TECHNICAL INFORMATION IS AVAILABLE ON OUR DASH BOARD. TO ACCESS [CLICK HERE](#)

Performance Data	Data Table
	Swept Graphs
	S-Parameter (S2P Files) Data Set (.zip file)
Case Style	DF782 (SOT 89) Plastic package, exposed paddle lead finish: Matte-tin
Tape & Reel Standard quantities available on reel	F55 7" reels with 20, 50, 100, 200, 500 or 1K devices
Suggested Layout for PCB Design	PL-370
Evaluation Board	TB-753+ (869-960 MHz) TB-752+ (2110-2140 MHz)
Environmental Ratings	ENV08T1

ESD RATING

Human Body Model (HBM): Class 2 (2000 to <4000V) in accordance with ANSI/ESD STM 5.1 - 2001

Machine Model (MM): Class M1 (50 to <100V) in accordance with ANSI/ESD STM5.2-2009

MSL RATING

Moisture Sensitivity: MSL1 in accordance with IPC/JEDEC J-STD-020D

MSL TEST FLOW CHART

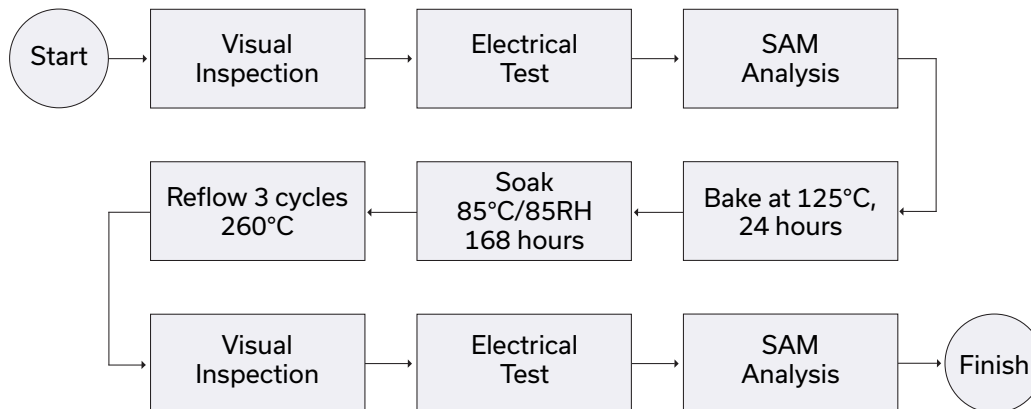



- NOTES**
- A. Performance and quality attributes and conditions not expressly stated in this specification document are intended to be excluded and do not form a part of this specification document.
 - B. Electrical specifications and performance data contained in this specification document are based on Mini-Circuit's applicable established test performance criteria and measurement instructions.
 - C. The parts covered by this specification document are subject to Mini-Circuits standard limited warranty and terms and conditions (collectively, "Standard Terms"); Purchasers of this part are entitled to the rights and benefits contained therein. For a full statement of the standard. Terms and the exclusive rights and remedies thereunder, please visit Mini-Circuits' website at www.minicircuits.com/MCLStore/terms.jsp



Looking for pricing, stock, or lifecycle information?

Click below to explore more details on WIN SOURCE:

-  [View GVA-91+ on WIN SOURCE](#)
-  [Mini-Circuits Information](#)

Optimize Your Supply Chain with WIN SOURCE Solutions

-  Global Sourcing Solution
-  Obsolete Management
-  Cost Control Management
-  Shortage Management
-  Alternative Solution
-  Excess Inventory Management