



THE DATASHEET OF G2405CG





Product Specification for Approval

WE ARE PLEASED IN SUBMITTING OUR SAMPLES WITH SPECIFICATION TO YOU FOR APPROVAL.

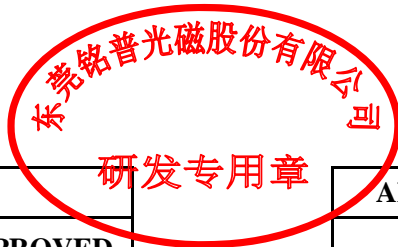
CUSTOMER	:		
DESCRIPTION	:	100/1000 BASE-T TRANSFORMER	
MNC P/N	:	G2405CG	
VERSION	:	A0	
CUSTOMER P/N	:		
ISSUED DATE	:	2020/04/27	
PHOTO OF PRODUCT	:		
WEIGHT	:		1.48g
MADE IN	:		CHINA



APPROVED BY MNC			APPROVED BY CUSTOMER
PREPARED BY  研发部 2020-04-27 符晶晶	CHECKED BY  研发部 2020-04-27 肖明华	APPROVED BY  研发部 2020-04-27 何校民	SIGNATURE OR STAMP

1. PLEASE SEND BACK US A COPY OF THE SPECIFICATION WITH YOUR STAMP OR SIGNATURE ONCE THE SAMPLES APPROVED.
2. IT WILL BE DEEMED THE SAMPLES TO BE APPROVED IF NO FEEDBACK.

东莞铭普光磁股份有限公司
 Add: Shipai Town, Dongguan City, Guangdong Province, China

TEL: +86-769-86921000
 FAX: +86-769-81701563

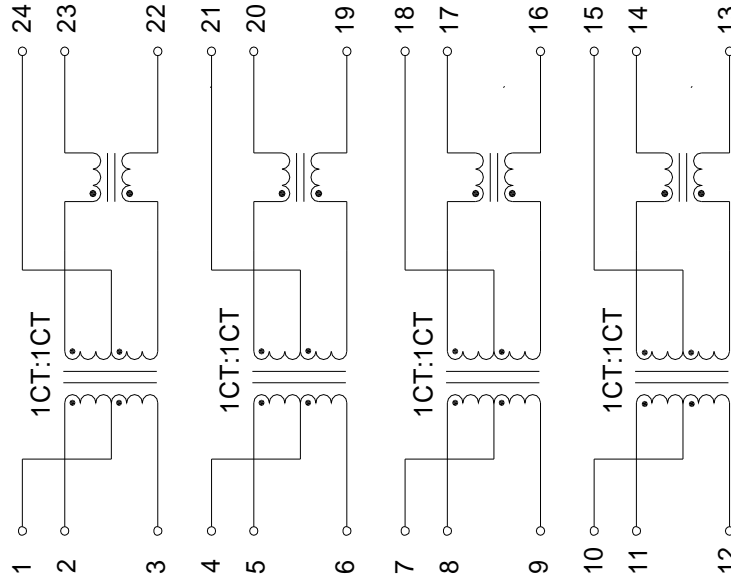
SPECIFICATION
Part No. G2405CG
B. SCHEMATIC :

C. ELECTRICAL SPECIFICATION @25°C

ITEM	SPECIFICATION	TEST CONDITION	TEST EQUIPMENT
INDUCTANCE :	350uH MIN.	100KHz 0.2V 8mA DC Bias	TH2819XB OR EQU.
LEAKAGE INDUCTANCE :	0.50uH MAX.	100KHz 0.2V	TH2819XB OR EQU.
INTERWINDING CAPACITANCE :	25pF TYP.	100KHz 0.2V	TH2819XB OR EQU.
DC RESISTANCE :	1.2Ω MAX.	AT 25 °C	TOS 8020 OR EQU.
TURNS RATIO :	1CT:1CT±5%		TH2819XB OR EQU.
POLARITY :	2-23,5-20,8-17,11-14 IN-PHASE		
INSERTION LOSS :	-1.1dB MAX.	0.5-100 MHz	E5061A OR EQU.
RETURN LOSS :	-18dB MIN.	0.5-40 MHz	E5061A OR EQU.
	-12+20log(f/80)dB MIN.	40.1-100 MHz	
CROSS TALK :	-35dB MIN.	0.5-40 MHz	E5061A OR EQU.
	-33+20*log(f/50)dB MIN.	40.1-100 MHz	
CMRR :	-30dB MIN.	0.5-100 MHz	E5061A OR EQU.
ISOLATION HI-POT :PRI TO SEC	1500VAC	1mA,60S	7152AB OR EQU.
	1650VAC	1mA,6S	
OPERATING TEMPERATURE	0°C TO 70°C		

PACKAGE

Part No. G2405CG

D. PACKING:

a. PACKAGING AS BELOW (ONLY FOR A REFERENCE):

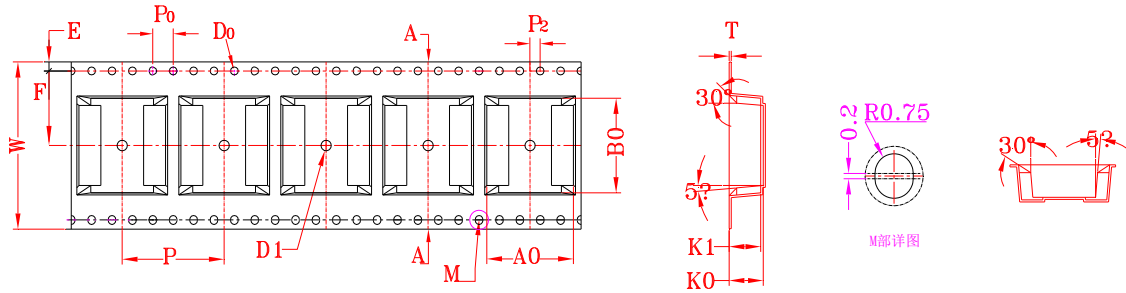

ITEM	W	A ₀	B ₀	K ₀	K ₁	P	F	E	D ₀	D ₁	P ₀	P ₂	T
DIM	32.00 ^{+0.30} _{-0.30}	17.0 ^{+0.10} _{-0.10}	18.10 ^{+0.10} _{-0.10}	6.70 ^{+0.10} _{-0.10}	6.20 ^{+0.10} _{-0.10}	20.00 ^{+0.10} _{-0.10}	14.2 ^{+0.10} _{-0.10}	1.75 ^{+0.10} _{-0.10}	1.50 ^{+0.10} _{-0.10}	2.00 ^{+0.10} _{-0.10}	4.00 ^{+0.10} _{-0.10}	2.00 ^{+0.10} _{-0.10}	0.40 ^{+0.05} _{-0.05}
ALTERNATE													

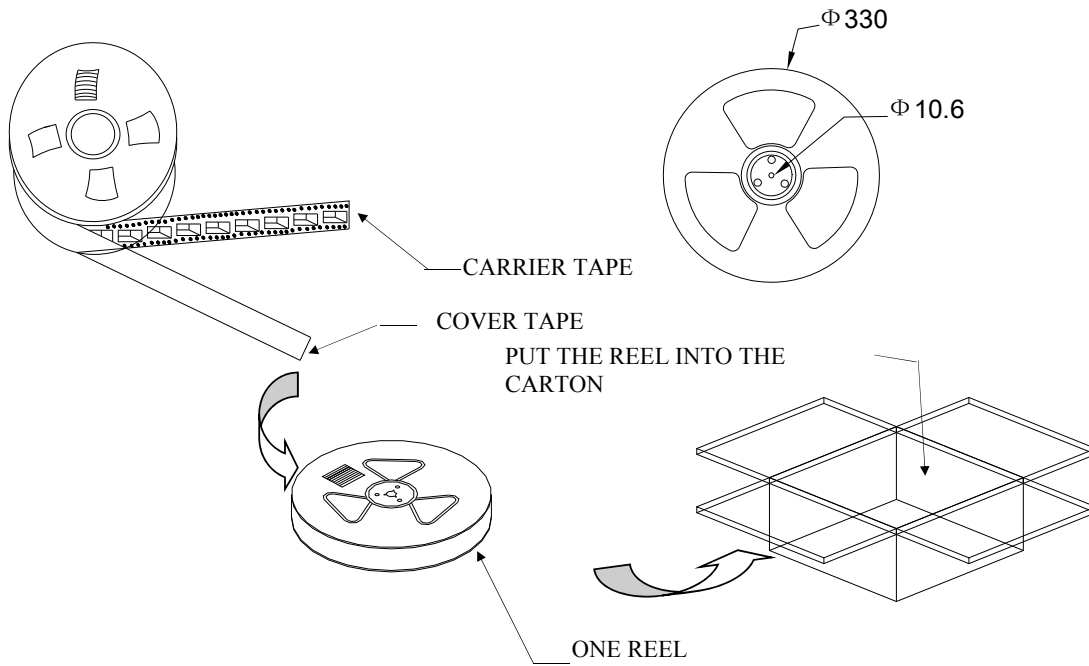

b. Q'TY:

400 PCS PER REEL
6 REELS PER CARTON
2400 PCS PER CARTON

c. LABEL:



REMARK:

ABOVE PACKING IS FOR YOUR REFERENCE ONLY, WHICH MIGHT BE CHANGED WITHOUT NOTICE.

MATERIAL LIST
Part No. G2405CG
E.BOM

MATERIAL LIST					
NO.	ITEM	MATERIAL	RATING	SUPPLIER OF MATERIAL	UL
1	CORE	Mn-Zn	-----	YEAN SHING	N/A
			-----	ZHONGSHAN CRC ELECTRONICS FACTORY	N/A
		Ni-Zn	-----	YEAN SHING	N/A
			-----	ZHONGSHAN CRC ELECTRONICS FACTORY	N/A
2	COPPER WIRE	QPN180	180℃	ZHUHAI SUNTEK WIRE CO.,LTD	E234867
		Polysol 180	180℃	ELEKTRISOLA(MALAYSIA) SDN.BHD.	E258243
3	CASE	WH-9100	V-0	WAH HONG INDUSTRIAL CORP	E150608
4	PIN	C5191	-----	SHENZHEN MINGSCHIN INDUSTRIAL MATERIAL CO.,LTD	N/A

RECOMMENDED SOLDERING PROFILE

Part No. G2405CG

a. RECOMMENDED REFLOW SOLDERING PROFILE:

below content is only for your reference

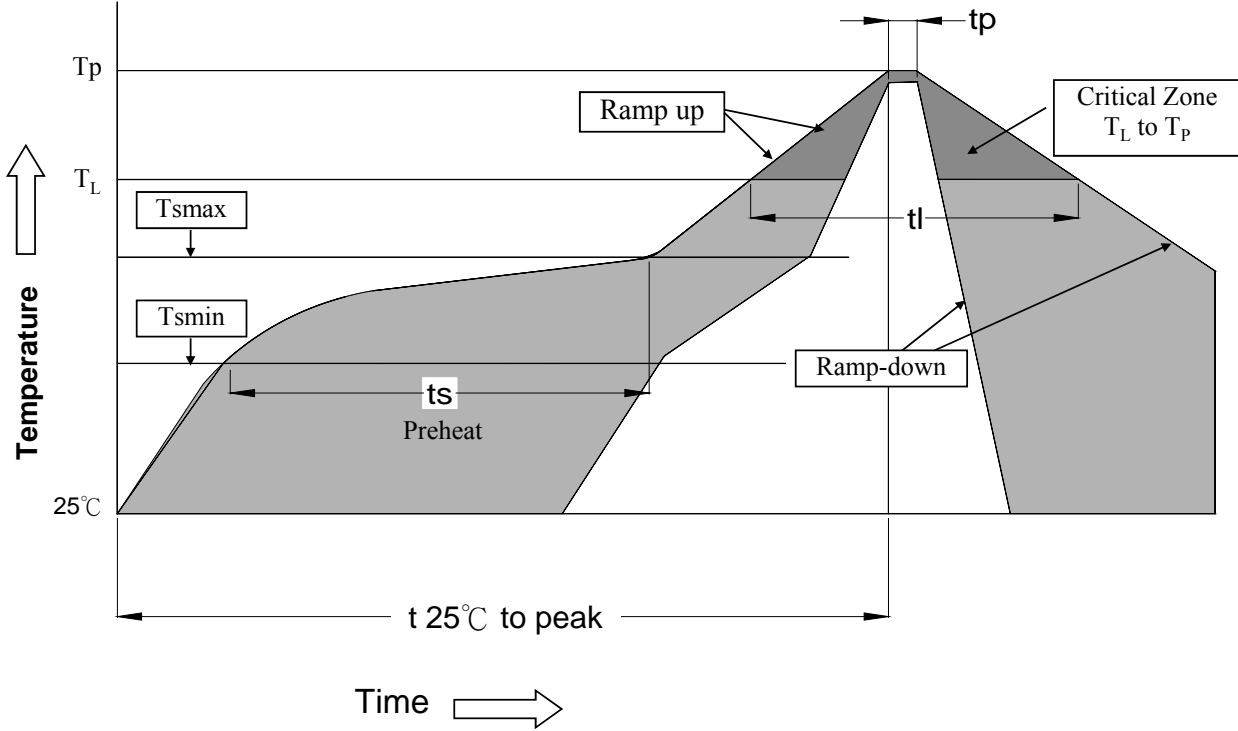



- $T_L = 217^{\circ}\text{C}$
- $T_p = 245^{\circ}\text{C}$
- $t_s = 60-180\text{s}$ $T_s \text{ max} = 200^{\circ}\text{C}$ $T_s \text{ min} = 150^{\circ}\text{C}$
- $t_L = 60-150\text{s}$ $t_p = 20-40\text{s}$ $T_{25^{\circ}\text{C to peak}} = 8\text{min max}$
- Ramp up rate = 3°C/s max
- Ramp down rate = 6°C/s max
- *RoHS Compliant
- *Solder Paste SAC 305 Sn 96.5/Ag 3.0/Cu 0.5
- *Silkscreen thickness: 0.15mm Min

b. MOISTURE SENSITIVE LEVEL:

- b.1. LEVEL: 1
- b.2. SHELF LIFE: UNLIMITED
- b.3. STORAGE CONDITION: $\cong 30^{\circ}\text{C}/85\% \text{ RH}$

Looking for pricing, stock, or lifecycle information?

Click below to explore more details on WIN SOURCE:

-  [View G2405CG on WIN SOURCE](#)
-  [Mentech Technology USA Inc. Information](#)

Optimize Your Supply Chain with WIN SOURCE Solutions

-  Global Sourcing Solution
-  Obsolete Management
-  Cost Control Management
-  Shortage Management
-  Alternative Solution
-  Excess Inventory Management