



**THE DATASHEET OF
FT886C-RT**



High Performance Non-isolated Buck LED Driver

FEATURES

- No Auxiliary winding for sensing and supplying
- Inductor current boundary conduction mode (BCM)
- Constant current control without secondary sense and feedback circuit
- Built-in 500V Power MOSFET
- $\pm 3\%$ LED current accuracy
- Ultra low operating current to improve efficiency
- Built-in line compensation
- Cycle-by-Cycle current limiting
- Precision OVP voltage for best LED open circuit protection
- LED short circuit protection
- Over temperature compensation
- CS resistor short circuit protection.
- Inductor short circuit protection.
- VCC under-voltage lockout
- Available in SOP8 and DIP8 packages

APPLICATIONS

- DC/DC or AC/DC LED Driver Applications
- Back Lighting of Flat Panel Displays

DESCRIPTION

FT886x is optimized for low cost non-isolated Buck switching mode LED driver applications. It operates in inductor current boundary conduction mode. With source driving architecture, special demagnetization sensing technology and the ultra low operating current, FT886xx doesn't need the auxiliary winding for output current sensing and chip power supplying. FT886x also integrates a 500V power MOSFET that further improves the system reliability and lowers the system cost and complexity.

Its highly integrated functions such as Leading Edge Blanking (LEB) and built-in line compensation offer users a high efficiency and low cost solution for constant current LED driver applications.

Furthermore, FT886x offers fruitful protections like LED open and short circuit protection, over temperature compensation, CS resistor and inductor short circuit protection.

The industry leading OVP voltage accuracy ensures the best LED open circuit protection

TYPICAL APPLICATION CIRCUIT

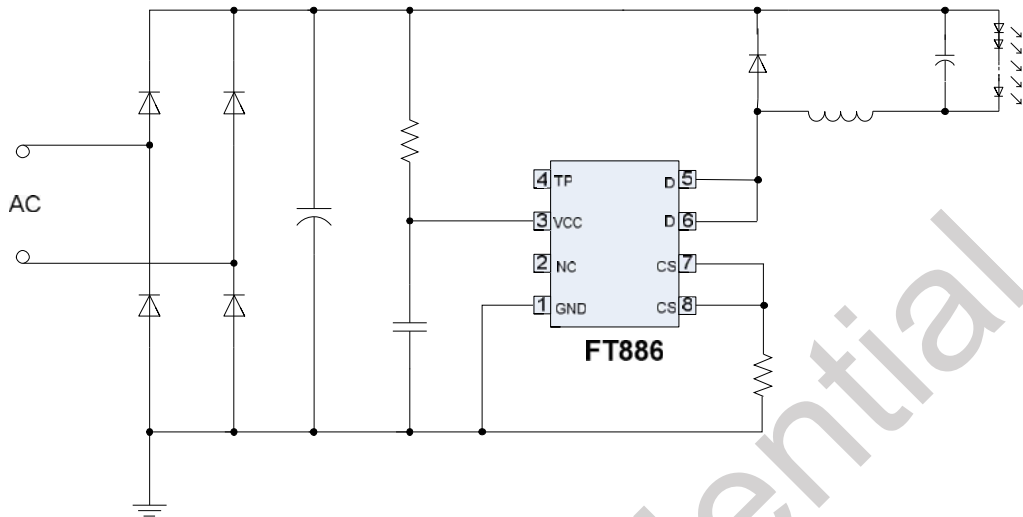

Figure 1: Typical Application Circuit

ABSOLUTE MAXIMUM RATINGS

CS to GND.....	-0.3V to +7V
VCC to GND.....	-0.3V to +20V
DRAIN to GND.....	-0.3V to +500V
TP to GND.....	-0.3V to +20V
Operating Temperature Range.....	-40°C to +125°C
Junction Temperature.....	-40°C to +150°C
Storage Temperature Range.....	-60°C to +150°C
ESD Protection HBM.....	2000V
ESD Protection MM.....	200V

* Stresses exceed those listed under “Absolute Maximum Ratings” may cause permanent damage to the device. Functional operation of the device at conditions beyond those listed in the specification is not guaranteed. Prolonged exposure to extreme conditions may affect device reliability or functionality.

PIN CONFIGURATION

Figure 2: Pin Assignments

TERMINAL DESCRIPTION

No.	PIN	FUNCTION
1	GND	Ground
2	NC	No connection
3	VCC	Power supply
4	TP	Test Point
5,6	D	Internal high voltage MOSFET Drain
7,8	CS	Current sense. This pin connects a current sense resistor to GND

Table1

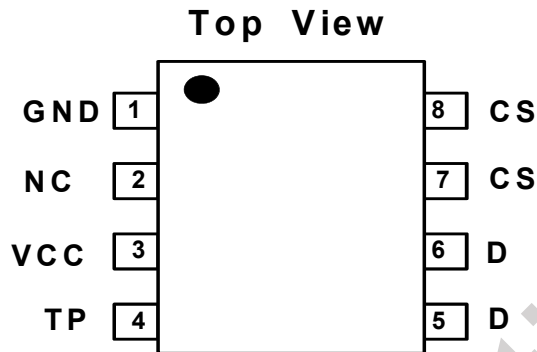
ORDERING INFORMATION

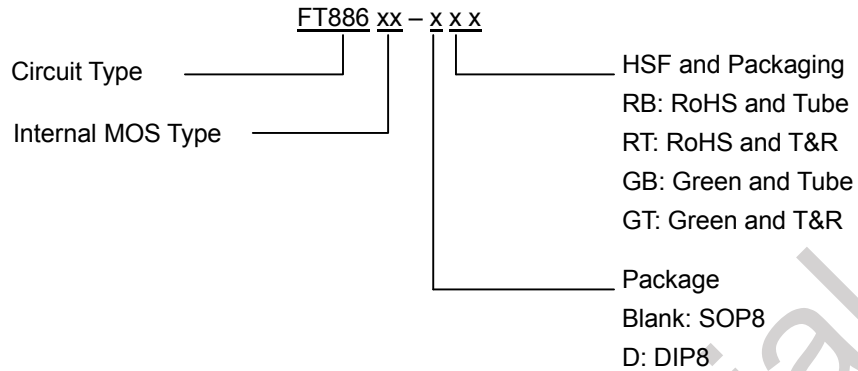

Internal MOS Type	Package	Max Output Current	Max Output Voltage/Power		HSF	Packaging	Ordering Code
			90V-264V	176V-264V			
A	SOP8	180mA	60V/10W	150V/18W	RoHS	Tube	FT886A-RB
						T&R	FT886A-RT
					Green	Tube	FT886A-GB
						T&R	FT886A-GT
C	SOP8	280mA	60V/15W	150V/27W	RoHS	Tube	FT886C-RB
						T&R	FT886C-RT
					Green	Tube	FT886C-GB
						T&R	FT886C-GT
CD	DIP8	380mA	60V/22W	150V/40W	RoHS	Tube	FT886CD-DRB
					Green	Tube	FT886CD-DGB

MARKING RULE

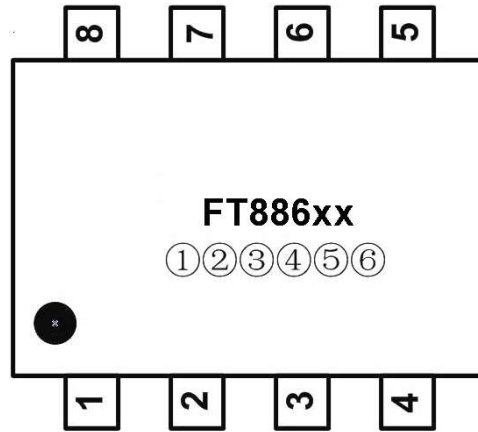

Figure 3 marking rule

①②③④⑤⑥ for internal reference

BLOCK DIAGRAM

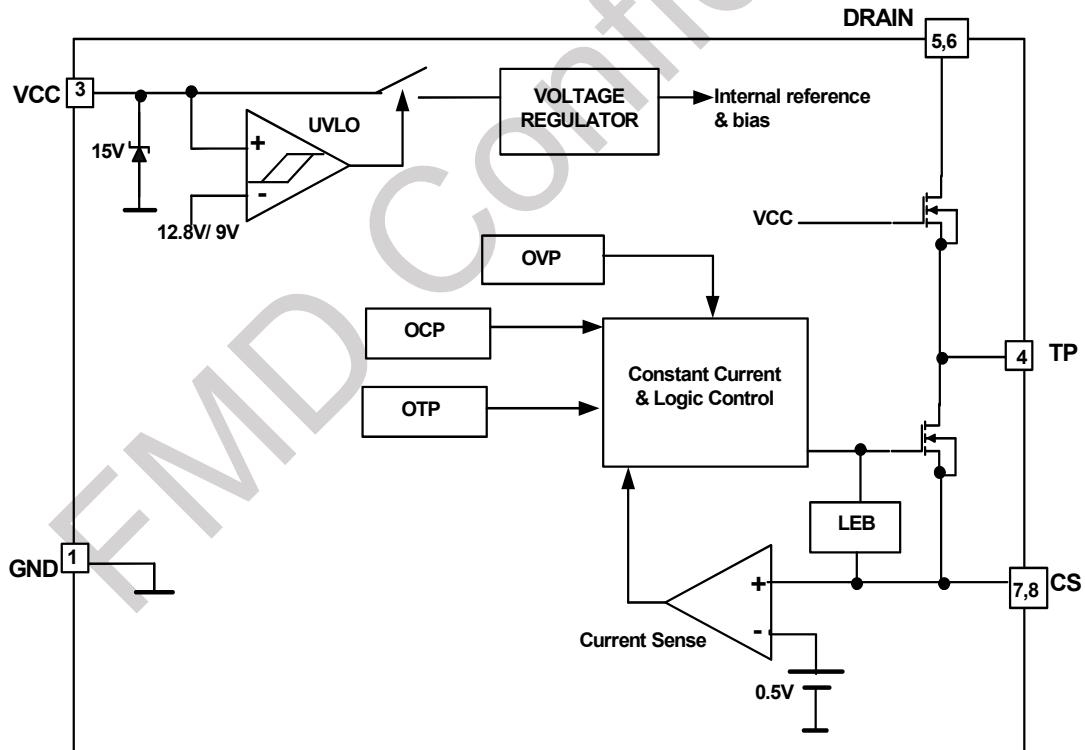

Figure 4 Block Diagram

ELECTRICAL CHARACTERISTICS

 (T_j = 25°C, VCC = 14V, unless otherwise specified)

Symbol	Parameter	Test Condition	Min	Typ	Max	Unit
SUPPLY VOLTAGE						
VCC _{on}	Turn-on threshold			12.8		V
VCC _{off}	Turn-off threshold			9		V
VCC _{clamp}	VCC clamp voltage			15.4		V
SUPPLY CURRENT						
I _{start-up}	Start-up current	Before turn-on, VCC=VCC _{on} -1V		100		uA
I _q	Quiescent Current			150		uA
CURRENT SENSE						
V _{CS_TH}	Threshold voltage for peak current limit		485	500	515	mV
T _{LEB}	Leading edge blanking time for current sense			350		ns
T _{DELAY}	Switch off delay time			200		ns
SWITCH FREQUENCY						
F _{MIN}	Minimum working frequency			5		KHz
T _{DIS}	Minimum inductor current discharge time			8.2		us
MOSFET (FT886A)						
R _{DS_ON}	Static drain-source on-resistance	V _{GS} =10V, I _{DS} =0.5A		10.8		Ω
BV _{DSS}	Drain-source breakdown voltage	V _{GS} =0V, I _{DS} =250uA	500			V
I _{DSS}	Drain-source leakage current	V _{GS} =0V, V _{DS} =500V			10	uA
I _{DMAX}	Maximum Drain Current	V _d =6V		0.50		A
MOSFET (FT886C)						
R _{DS_ON}	Static drain-source on-resistance	V _{GS} =10V, I _{DS} =0.5A		4.6		Ω
BV _{DSS}	Drain-source breakdown voltage	V _{GS} =0V, I _{DS} =250uA	500			V
I _{DSS}	Drain-source leakage current	V _{GS} =0V, V _{DS} =500V			10	uA
I _{DMAX}	Maximum Drain Current	V _d =6V		1.0		A
Over Temperature Compensation						

T_{SD}	Thermal compensation threshold			150		°C
T_{SD_HYS}	Thermal compensation hysteresis			25		°C

Table2

FMD Confidential

FUNCTIONAL DESCRIPTION

Operating Description

FT886x is a cost effective and high-performance non-isolated Buck LED driver. It operates in inductor current boundary conduction mode. The constant current (CC) control is achieved accurately without the secondary feedback circuit and auxiliary winding.

Startup Control

The start-up current in FT886x is designed to be 100uA. The VCC capacitor will be charged through a start-up resistor when the system is powered on. Once the VCC voltage reaches the start-up threshold, FT886x will start to switch. The VCC voltage of FT886x is clamped at 15V. Due to the ultra-low operating current, the auxiliary winding is not needed to supply the IC, good efficiency is achieved.

Constant Current Control

Cycle-by-Cycle current sense is adopted in FT886x, and the voltage on CS will be compared with the internal 500mV reference voltage through the current sense comparator, the MOSFET will be switched off when the voltage on CS reaches the threshold.

The primary peak current is given by: $I_{P_PK} = \frac{500}{R_{CS}} (mA)$

The current in LED can be calculated by the equation: $I_{OUT} = \frac{I_{P_PK}}{2}$

Where, I_{P_PK} is the peak current in MOSFET,

Leading Edge Blanking (LEB)

Each time the power transistor is switched on, a turn-on spike occurs at the sense resistor. To avoid premature termination of the switching pulse, a 350ns leading edge blanking time is built in. Conventional RC filtering can therefore be omitted. During this blanking period, the current limit comparator is disabled and can not switch off the gate driver.

Over Voltage Protection (OVP)

FT886x features the industry leading output OVP accuracy. Output LED open circuit will trigger the over-voltage protection logic and latch, the system stops switching immediately. VCC will be pulled down and charged up again, the system works in a hiccup mode.

LED Short Circuit Protection

When LED short circuit is detected, the system works at minimum frequency ($F_{op}=5KHz$), so the power consumption is low.

CS Resistor Short or Inductor Saturation

If these catastrophic fault conditions happen, the internal fast fault detection circuit will trigger and latch, the system stops switching immediately, the system VCC will be pulled down and charged up again, system working in a hiccup mode.

Over Temperature Compensation

FT886x senses the die temperature after start up, and the thermal compensation threshold is set to 150°C with a 25°C hysteresis. When FT886x temperature rises and reaches the 150°C threshold, the switching frequency will be reduced to approximately 18kHz, so the output current will decrease proportionally, until the IC temperature falls 25°C below the thermal compensation trigger point, at which point the output current will recover to 100% of its designed target.

FMD Confidential

SOP8 PACKAGE OUTLINE DIMENSIONS

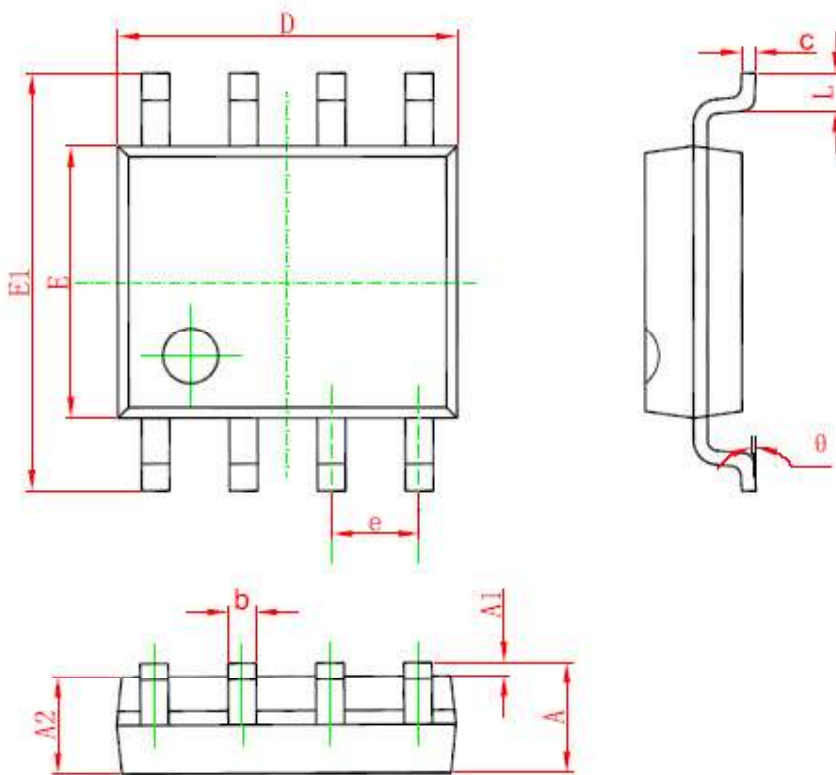

Symbol	Dimensions In Millimeters		Dimensions In Inches	
	Min	Max	Min	Max
A	1.350	1.750	0.053	0.069
A1	0.100	0.250	0.004	0.010
A2	1.350	1.550	0.053	0.061
b	0.330	0.510	0.013	0.020
c	0.170	0.250	0.006	0.010
D	4.700	5.100	0.185	0.200
E	3.800	4.000	0.150	0.157
E1	5.800	6.200	0.228	0.244
e	1.270 (BSC)		0.050 (BSC)	
L	0.400	1.270	0.016	0.050
θ	0°	8°	0°	8°

DIP8 PACKAGE OUTLINE DIMENSIONS

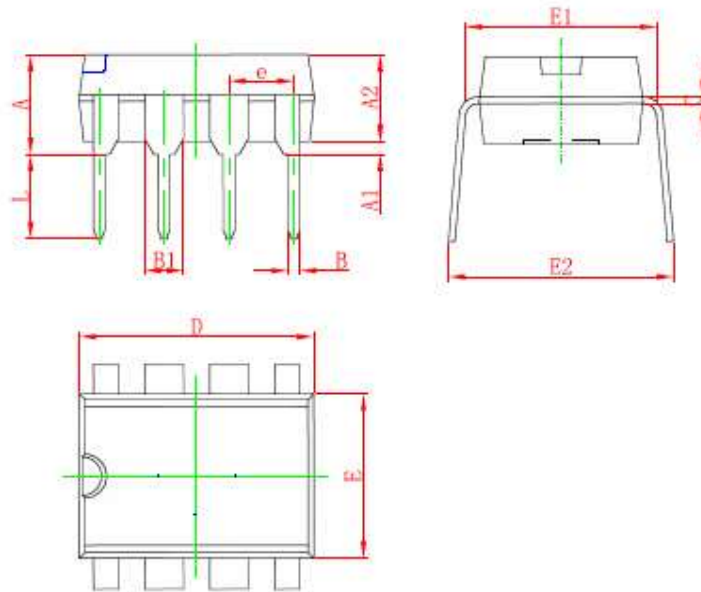

Symbol	Dimensions In Millimeters		Dimensions In Inches	
	Min	Max	Min	Max
A	3.710	4.310	0.146	0.170
A1	0.510		0.020	
A2	3.200	3.600	0.126	0.142
B	0.380	0.570	0.015	0.022
B1	1.524 (BSC)		0.060 (BSC)	
C	0.204	0.360	0.008	0.014
D	9.000	9.400	0.354	0.370
E	6.200	6.600	0.244	0.260
E1	7.320	7.920	0.288	0.312
e	2.540 (BSC)		0.100 (BSC)	
L	3.000	3.600	0.118	0.142
E2	8.400	9.000	0.331	0.354

Fremont Micro Devices (SZ) Limited

#5-8, 10/F, Changhong Building, Ke-Ji Nan 12 Road, Nanshan District, Shenzhen

Tel: (86 755) 86117811

Fax: (86 755) 86117810

Fremont Micro Devices (Hong Kong) Limited

#16, 16/F, Blk B, Veristrong Industrial Centre, 34-36 Au Pui Wan Street, Fotan, Shatin, Hong Kong

Tel: (852) 27811186

Fax: (852) 27811144

Fremont Micro Devices (USA), Inc.

42982 Osgood Road Fremont, CA 94539

Tel: (1-510) 668-1321

Fax: (1-510) 226-9918

Web Site: <http://www.fremontmicro.com/>

* Information furnished is believed to be accurate and reliable. However, Fremont Micro Devices, Incorporated (BVI) assumes no responsibility for the consequences of use of such information or for any infringement of patents of other rights of third parties which may result from its use. No license is granted by implication or otherwise under any patent rights of Fremont Micro Devices, Incorporated (BVI). Specifications mentioned in this publication are subject to change without notice. This publication supersedes and replaces all information previously supplied. Fremont Micro Devices, Incorporated (BVI) products are not authorized for use as critical components in life support devices or systems without express written approval of Fremont Micro Devices, Incorporated (BVI). The FMD logo is a registered trademark of Fremont Micro Devices, Incorporated (BVI). All other names are the property of their respective owners.

Looking for pricing, stock, or lifecycle information?

Click below to explore more details on WIN SOURCE:

- [View FT886C-RT on WIN SOURCE](#)
- [Fremont Micro Devices USA Information](#)

Optimize Your Supply Chain with WIN SOURCE Solutions

- ✓ Global Sourcing Solution
- ✓ Obsolete Management
- ✓ Cost Control Management
- ✓ Shortage Management
- ✓ Alternative Solution
- ✓ Excess Inventory Management