



# THE DATASHEET OF FOD617A3S



# FOD814 Series, FOD617 Series, FOD817 Series 4-Pin High Operating Temperature Phototransistor Optocouplers

## Features

- AC input response (FOD814 only)
- Applicable to Pb-free IR reflow soldering
- Compact 4-pin package
- Current transfer ratio in selected groups:
 

FOD617A: 40–80%	FOD817: 50–600%
FOD617B: 63–125%	FOD817A: 80–160%
FOD617C: 100–200%	FOD817B: 130–260%
FOD617D: 160–320%	FOD817C: 200–400%
FOD814: 20–300%	FOD817D: 300–600%
FOD814A: 50–150%	
- C-UL, UL and VDE approved
- High input-output isolation voltage of 5000Vrms
- Minimum  $BV_{CEO}$  of 70V guaranteed
- Higher operating temperatures (versus H11AXXX counterparts)

## Applications

### FOD814 Series

- AC line monitor
- Unknown polarity DC sensor
- Telephone line interface

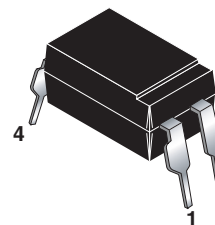
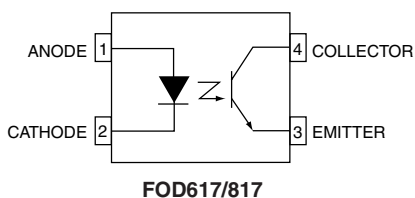
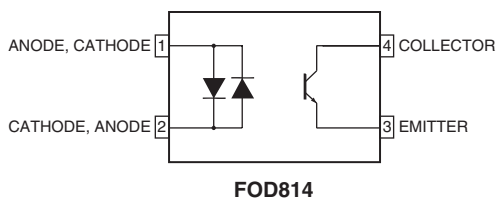
### FOD617 and FOD817 Series

- Power supply regulators
- Digital logic inputs
- Microprocessor inputs

## Description

The FOD814 consists of two gallium arsenide infrared emitting diodes, connected in inverse parallel, driving a silicon phototransistor output in a 4-pin dual in-line package. The FOD617/817 Series consists of a gallium arsenide infrared emitting diode driving a silicon phototransistor in a 4-pin dual in-line package.

## Functional Block Diagram



**Absolute Maximum Ratings** ( $T_A = 25^\circ\text{C}$  Unless otherwise specified.)

Symbol	Parameter	Value		Units
		FOD814	FOD617/817	
<b>TOTAL DEVICE</b>				
$T_{STG}$	Storage Temperature	-55 to +150		$^\circ\text{C}$
$T_{OPR}$	Operating Temperature	-55 to +105	-55 to +110	$^\circ\text{C}$
$T_{SOL}$	Lead Solder Temperature	260 for 10 sec		$^\circ\text{C}$
$P_{TOT}$	Total Power Dissipation	200		mW
<b>EMITTER</b>				
$I_F$	Continuous Forward Current	$\pm 50$	50	mA
$V_R$	Reverse Voltage	-	6	
$P_D$	Power Dissipation	70		mW
	Derate above $100^\circ\text{C}$	1.7		$\text{mW}/^\circ\text{C}$
<b>DETECTOR</b>				
$V_{CEO}$	Collector-Emitter Voltage	70		V
$V_{ECO}$	Emitter-Collector Voltage	6	6 (FOD817) 7 (FOD617)	V
$I_C$	Continuous Collector Current	50		mA
$P_C$	Collector Power Dissipation	150		mW
	Derate above $90^\circ\text{C}$	2.9		$\text{mW}/^\circ\text{C}$

**Electrical Characteristics** ( $T_A = 25^\circ\text{C}$  Unless otherwise specified.)

**Individual Component Characteristics**

Symbol	Parameter	Device	Test Conditions	Min.	Typ.*	Max.	Unit
<b>EMITTER</b>							
$V_F$	Forward Voltage	FOD814	$I_F = \pm 20\text{mA}$	–	1.2	1.4	V
		FOD617	$I_F = 60\text{mA}$	–	1.35	1.65	
		FOD817	$I_F = 20\text{mA}$	–	1.2	1.4	
$I_R$	Reverse Leakage Current	FOD617	$V_R = 6.0\text{V}$	–	0.001	10	$\mu\text{A}$
		FOD817	$V_R = 4.0\text{V}$	–	–	10	
$C_t$	Terminal Capacitance	FOD814	$V = 0, f = 1\text{kHz}$	–	50	250	pF
		FOD617	$V = 0, f = 1\text{kHz}$	–	30	250	
		FOD817	$V = 0, f = 1\text{kHz}$	–	30	250	
<b>DETECTOR</b>							
$I_{CEO}$	Collector Dark Current	FOD814	$V_{CE} = 20\text{V}, I_F = 0$	–	–	100	nA
		FOD617C/D	$V_{CE} = 10\text{V}, I_F = 0$	–	1	100	
		FOD617A/B	$V_{CE} = 10\text{V}, I_F = 0$	–	1	50	
		FOD817	$V_{CE} = 20\text{V}, I_F = 0$	–	–	100	
$BV_{CEO}$	Collector-Emitter Breakdown Voltage	FOD814	$I_C = 0.1\text{mA}, I_F = 0$	70	–	–	V
		FOD617	$I_C = 100\mu\text{A}, I_F = 0$	70	–	–	
		FOD817	$I_C = 0.1\text{mA}, I_F = 0$	70	–	–	
$BV_{ECO}$	Emitter-Collector Breakdown Voltage	FOD814	$I_E = 10\mu\text{A}, I_F = 0$	6	–	–	V
		FOD617	$I_E = 10\mu\text{A}, I_F = 0$	7	–	–	
		FOD817	$I_E = 10\mu\text{A}, I_F = 0$	6	–	–	

**Transfer Characteristics** ( $T_A = 25^\circ\text{C}$  Unless otherwise specified.)

Symbol	DC Characteristic	Device	Test Conditions	Min.	Typ.*	Max.	Unit
CTR	Current Transfer Ratio	FOD814	$I_F = \pm 1\text{mA}, V_{CE} = 5\text{V}^{(1)}$	20	–	300	%
		FOD814A		50	–	150	
		FOD617A	$I_F = 10\text{mA}, V_{CE} = 5\text{V}^{(1)}$	40	–	80	
		FOD617B		63	–	125	
		FOD617C		100	–	200	
		FOD617D		160	–	320	
		FOD617A	$I_F = 1\text{mA}, V_{CE} = 5\text{V}^{(1)}$	13	–	–	
		FOD617B		22	–	–	
		FOD617C		34	–	–	
		FOD617D		56	–	–	
		FOD817	$I_F = 5\text{mA}, V_{CE} = 5\text{V}^{(1)}$	50	–	600	
		FOD817A		80	–	160	
		FOD817B		130	–	260	
		FOD817C		200	–	400	
		FOD817D		300	–	600	
$V_{CE(sat)}$	Collector-Emitter Saturation Voltage	FOD814	$I_F = \pm 20\text{mA}, I_C = 1\text{mA}$	–	0.1	0.2	V
		FOD617	$I_F = 10\text{mA}, I_C = 2.5\text{mA}$	–	–	0.4	
		FOD817	$I_F = 20\text{mA}, I_C = 1\text{mA}$	–	0.1	0.2	

\*Typical values at  $T_A = 25^\circ\text{C}$

**Transfer Characteristics** (Continued) ( $T_A = 25^\circ\text{C}$  Unless otherwise specified.)

Symbol	AC Characteristic	Device	Test Conditions	Min.	Typ.*	Max.	Unit
$f_C$	Cut-Off Frequency	FOD814	$V_{CE} = 5\text{V}$ , $I_C = 2\text{mA}$ , $R_L = 100\Omega$ , -3dB	15	80	–	kHz
$t_r$	Response Time (Rise)	FOD814	$V_{CE} = 2\text{V}$ , $I_C = 2\text{mA}$ , $R_L = 100\Omega^{(2)}$	–	4	18	$\mu\text{s}$
		FOD617					
		FOD817					
$t_f$	Response Time (Fall)	FOD814		–	3	18	$\mu\text{s}$
		FOD617					
		FOD817					

**Isolation Characteristics**

Symbol	Characteristic	Device	Test Conditions	Min.	Typ.*	Max.	Units
$V_{ISO}$	Input-Output Isolation Voltage <sup>(3)</sup>	FOD814	$f = 60\text{Hz}$ , $t = 1\text{ min}$ , $I_{I-O} \leq 2\mu\text{A}$	5000			Vac(rms)
		FOD617					
		FOD817					
$R_{ISO}$	Isolation Resistance	FOD814	$V_{I-O} = 500\text{VDC}$	$5 \times 10^{10}$	$1 \times 10^{11}$	–	$\Omega$
		FOD617					
		FOD817					
$C_{ISO}$	Isolation Capacitance	FOD814	$V_{I-O} = 0$ , $f = 1\text{ MHz}$		0.6	1.0	pf
		FOD617					
		FOD817					

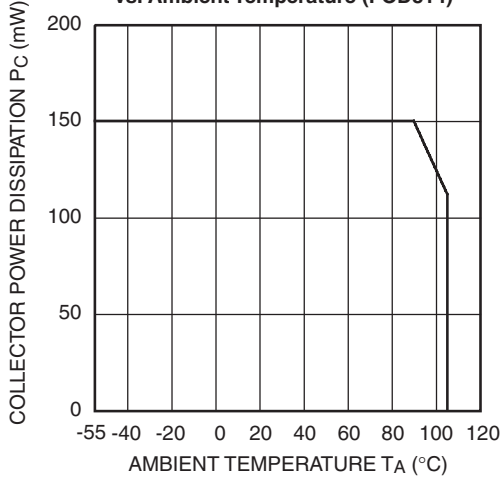
\*Typical values at  $T_A = 25^\circ\text{C}$

**Notes:**

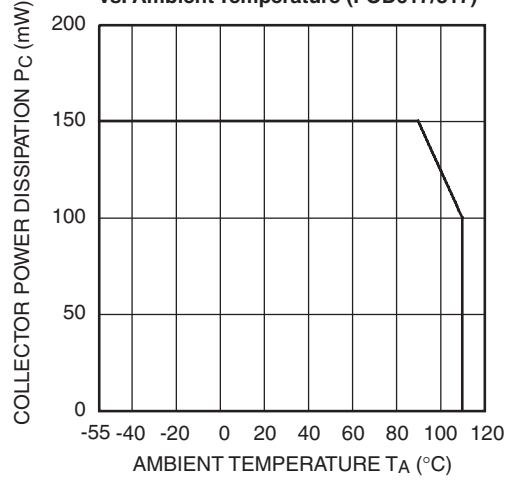
1. Current Transfer Ratio (CTR) =  $I_C/I_F \times 100\%$ .
2. For test circuit setup and waveforms, refer to page 4.
3. For this test, Pins 1 and 2 are common, and Pins 3 and 4 are common.

**Typical Electrical/Optical Characteristics** ( $T_A = 25^\circ\text{C}$  Unless otherwise specified.)

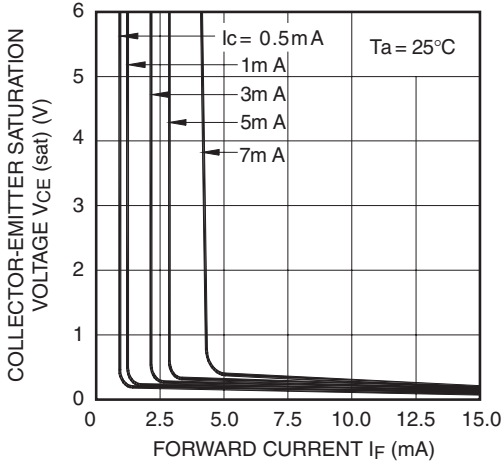
**Fig. 1 Collector Power Dissipation vs. Ambient Temperature (FOD814)**



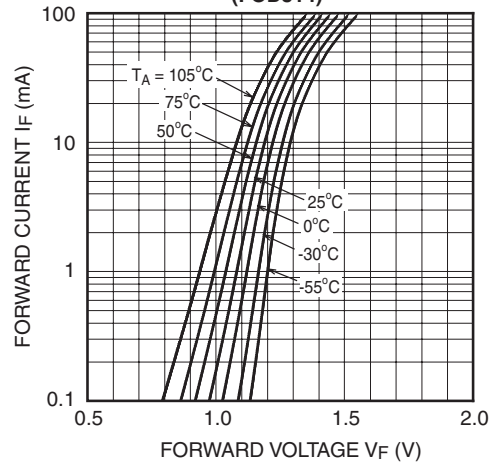
**Fig. 2 Collector Power Dissipation vs. Ambient Temperature (FOD617/817)**



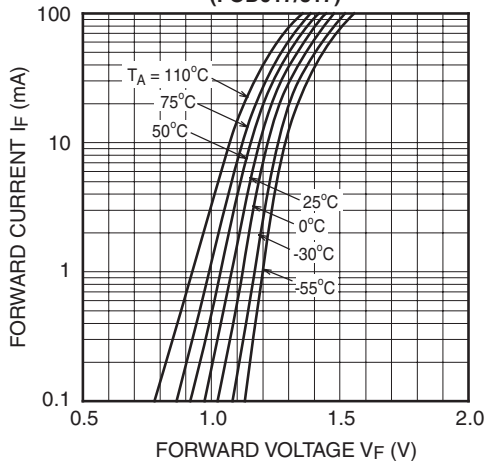
**Fig. 3 Collector-Emitter Saturation Voltage vs. Forward Current**



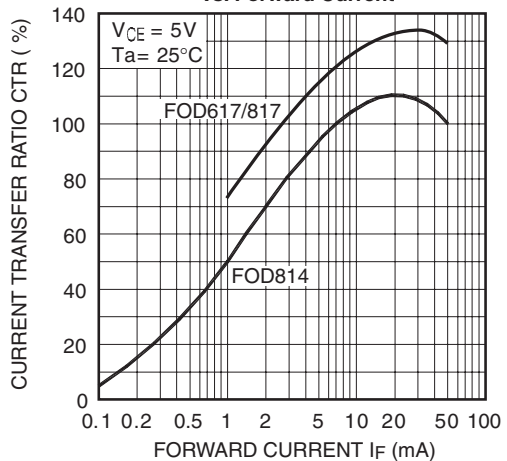
**Fig. 4 Forward Current vs. Forward Voltage (FOD814)**



**Fig. 5 Forward Current vs. Forward Voltage (FOD617/817)**

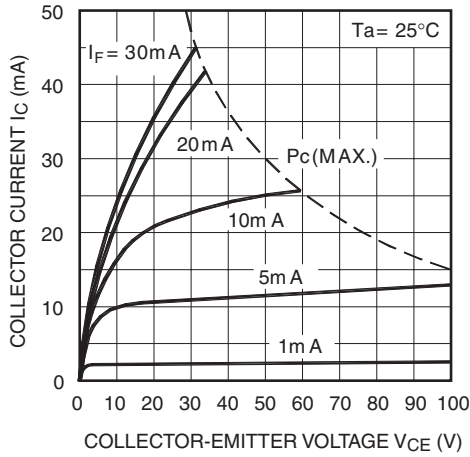


**Fig. 6 Current Transfer Ratio vs. Forward Current**

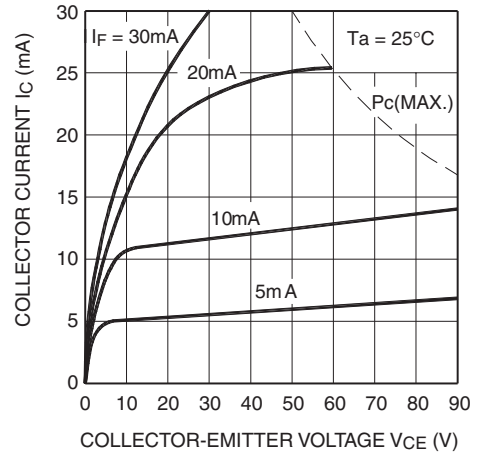


**Typical Electrical/Optical Characteristics** (Continued) ( $T_A = 25^\circ\text{C}$  Unless otherwise specified.)

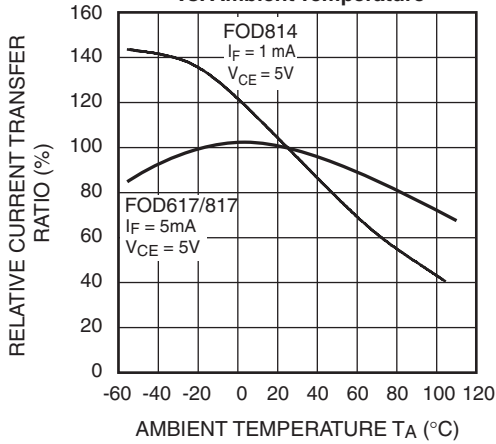
**Fig. 7 Collector Current vs. Collector-Emitter Voltage (FOD814)**



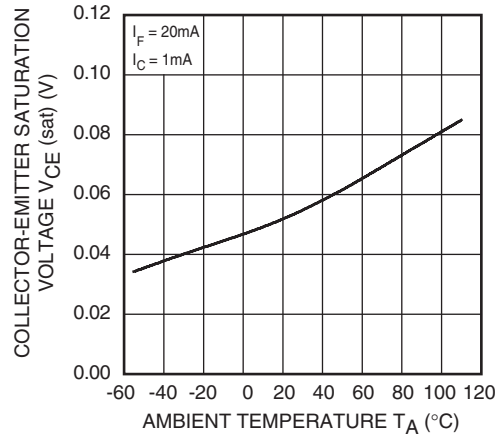
**Fig. 8 Collector Current vs. Collector-Emitter Voltage (FOD617/817)**



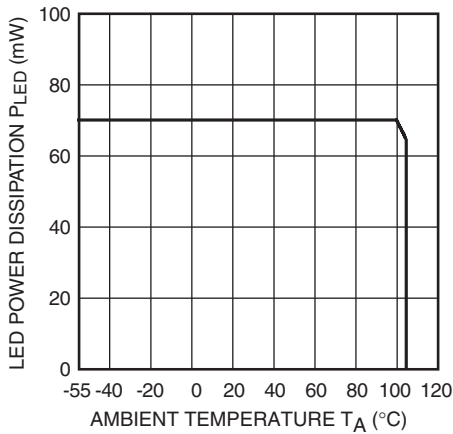
**Fig. 9 Relative Current Transfer Ratio vs. Ambient Temperature**



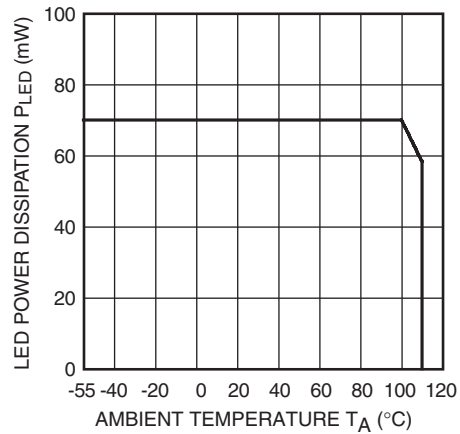
**Fig. 10 Collector-Emitter Saturation Voltage vs. Ambient Temperature**



**Fig. 11 LED Power Dissipation vs. Ambient Temperature (FOD814)**

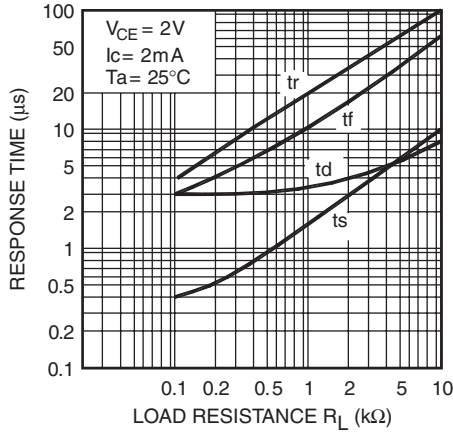


**Fig. 12 LED Power Dissipation vs. Ambient Temperature (FOD617/817)**

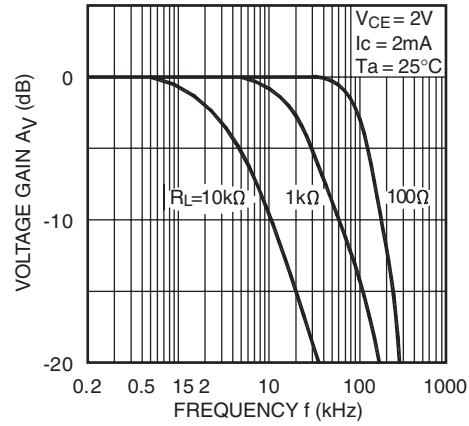


**Typical Electrical/Optical Characteristics** (Continued) ( $T_A = 25^\circ\text{C}$  Unless otherwise specified.)

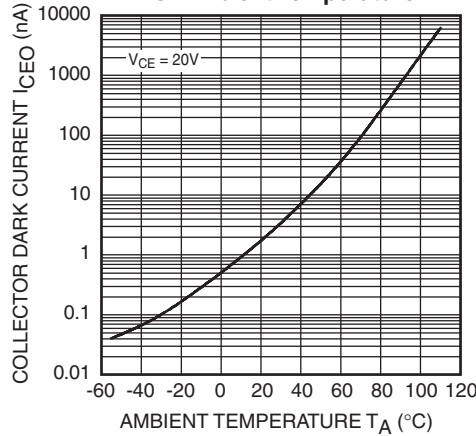
**Fig. 13 Response Time vs. Load Resistance**



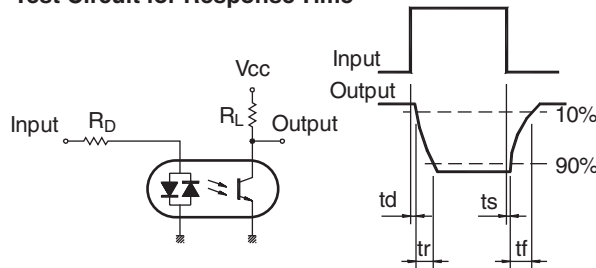
**Fig. 14 Frequency Response**



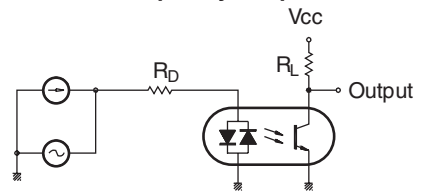
**Fig. 15 Collector Dark Current vs. Ambient Temperature**



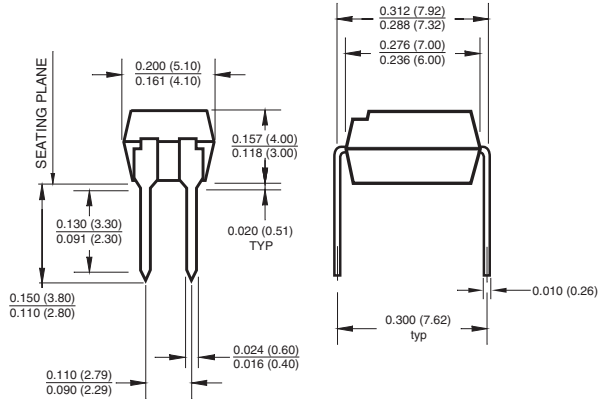
**Test Circuit for Response Time**



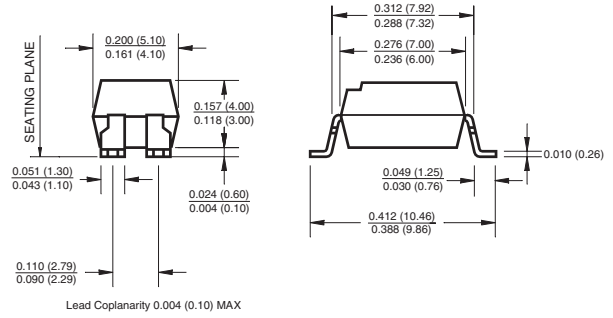
**Test Circuit for Frequency Response**



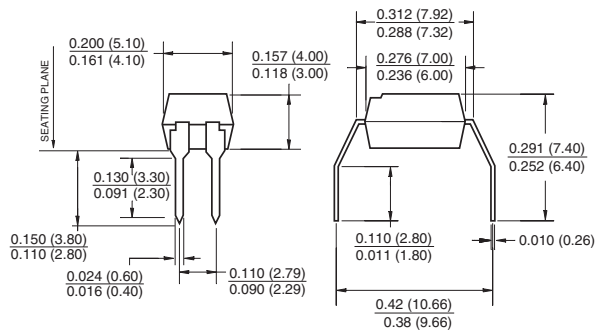
### Package Dimensions (Through Hole)



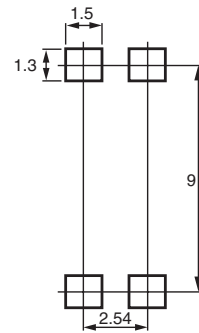
### Package Dimensions (Surface Mount)



### Package Dimensions (0.4" Lead Spacing)



### Footprint Dimensions (Surface Mount)



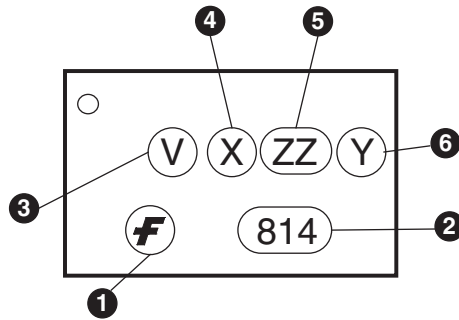
**Note:**

All dimensions are in inches (millimeters).

### Ordering Information

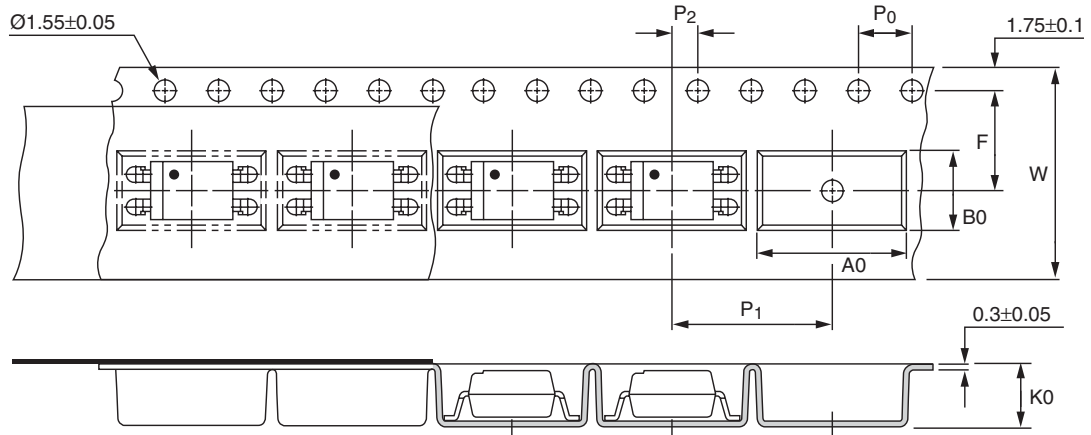
Option	Part Number Example	Description
S	FOD814S	Surface Mount Lead Bend
SD	FOD814SD	Surface Mount; Tape and reel
W	FOD814W	0.4" Lead Spacing
300	FOD814300	VDE Approved
300W	FOD814300W	VDE Approved, 0.4" Lead Spacing
3S	FOD8143S	VDE Approved, Surface Mount
3SD	FOD8143SD	VDE Approved, Surface Mount, Tape & Reel

### Marking Information



Definitions	
1	Fairchild logo
2	Device number
3	VDE mark (Note: Only appears on parts ordered with VDE option – See order entry table)
4	One digit year code
5	Two digit work week ranging from '01' to '53'
6	Assembly package code

### Carrier Tape Specifications

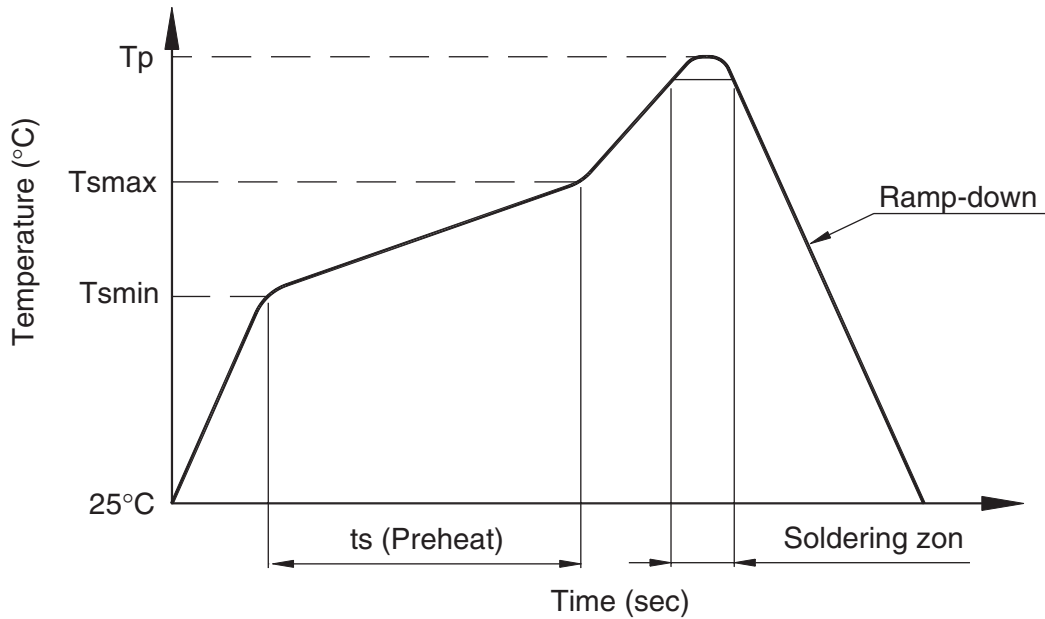


**Note:**

All dimensions are in millimeters.

Description	Symbol	Dimensions in mm (inches)
Tape wide	W	$16 \pm 0.3$ (.63)
Pitch of sprocket holes	$P_0$	$4 \pm 0.1$ (.15)
Distance of compartment	F	$7.5 \pm 0.1$ (.295)
	$P_2$	$2 \pm 0.1$ (.079)
Distance of compartment to compartment	$P_1$	$12 \pm 0.1$ (.472)
Compartment	$A_0$	$10.45 \pm 0.1$ (.411)
	$B_0$	$5.30 \pm 0.1$ (.209)
	$K_0$	$4.25 \pm 0.1$ (.167)

**Lead Free Recommended IR Reflow Condition**



Profile Feature	Pb-Sn solder assembly	Lead Free assembly
Preheat condition (Tsmmin-Tsmmax / ts)	100°C ~ 150°C 60 ~ 120 sec	150°C ~ 200°C 60 ~ 120 sec
Melt soldering zone	183°C 60 ~ 120 sec	217°C 30 ~ 90 sec
Peak temperature (Tp)	240 +0/-5°C	260 +0/-5°C
Ramp-down rate	6°C/sec max.	6°C/sec max.

**Recommended Wave Soldering condition**

Profile Feature	For all solder assembly
Peak temperature (Tp)	Max 260°C for 10 sec

## TRADEMARKS

The following are registered and unregistered trademarks Fairchild Semiconductor owns or is authorized to use and is not intended to be an exhaustive list of all such trademarks.

ACEx™	FAST®	ISOPLANAR™	PowerEdge™	SuperFET™
ActiveArray™	FASTr™	LittleFET™	PowerSaver™	SuperSOT™-3
Bottomless™	FPS™	MICROCOUPLER™	PowerTrench®	SuperSOT™-6
Build it Now™	FRFET™	MicroFET™	QFET®	SuperSOT™-8
CoolFET™	GlobalOptoisolator™	MicroPak™	QS™	SyncFET™
CROSSVOLT™	GTO™	MICROWIRE™	QT Optoelectronics™	TCM™
DOME™	HiSeC™	MSX™	Quiet Series™	TinyLogic®
EcoSPARK™	I <sup>2</sup> C™	MSXPro™	RapidConfigure™	TINYOPTO™
E <sup>2</sup> CMOS™	i-Lo™	OCX™	RapidConnect™	TruTranslation™
EnSigna™	ImpliedDisconnect™	OCXPro™	μSerDes™	UHC™
FACT™	IntelliMAX™	OPTOLOGIC®	ScalarPump™	UniFET™
FACT Quiet Series™		OPTOPLANAR™	SILENT SWITCHER®	UltraFET®
Across the board. Around the world.™		PACMAN™	SMART START™	VCX™
The Power Franchise®		POP™	SPM™	Wire™
Programmable Active Droop™		Power247™	Stealth™	

## DISCLAIMER

FAIRCHILD SEMICONDUCTOR RESERVES THE RIGHT TO MAKE CHANGES WITHOUT FURTHER NOTICE TO ANY PRODUCTS HEREIN TO IMPROVE RELIABILITY, FUNCTION OR DESIGN. FAIRCHILD DOES NOT ASSUME ANY LIABILITY ARISING OUT OF THE APPLICATION OR USE OF ANY PRODUCT OR CIRCUIT DESCRIBED HEREIN; NEITHER DOES IT CONVEY ANY LICENSE UNDER ITS PATENT RIGHTS, NOR THE RIGHTS OF OTHERS. THESE SPECIFICATIONS DO NOT EXPAND THE TERMS OF FAIRCHILD'S WORLDWIDE TERMS AND CONDITIONS, SPECIFICALLY THE WARRANTY THEREIN, WHICH COVERS THESE PRODUCTS.

## LIFE SUPPORT POLICY

FAIRCHILD'S PRODUCTS ARE NOT AUTHORIZED FOR USE AS CRITICAL COMPONENTS IN LIFE SUPPORT DEVICES OR SYSTEMS WITHOUT THE EXPRESS WRITTEN APPROVAL OF FAIRCHILD SEMICONDUCTOR CORPORATION.

As used herein:

- Life support devices or systems are devices or systems which, (a) are intended for surgical implant into the body, or (b) support or sustain life, or (c) whose failure to perform when properly used in accordance with instructions for use provided in the labeling, can be reasonably expected to result in significant injury to the user.
- A critical component is any component of a life support device or system whose failure to perform can be reasonably expected to cause the failure of the life support device or system, or to affect its safety or effectiveness.

## PRODUCT STATUS DEFINITIONS

### Definition of Terms

Datasheet Identification	Product Status	Definition
Advance Information	Formative or In Design	This datasheet contains the design specifications for product development. Specifications may change in any manner without notice.
Preliminary	First Production	This datasheet contains preliminary data, and supplementary data will be published at a later date. Fairchild Semiconductor reserves the right to make changes at any time without notice in order to improve design.
No Identification Needed	Full Production	This datasheet contains final specifications. Fairchild Semiconductor reserves the right to make changes at any time without notice in order to improve design.
Obsolete	Not In Production	This datasheet contains specifications on a product that has been discontinued by Fairchild semiconductor. The datasheet is printed for reference information only.

Rev. I19

## Looking for pricing, stock, or lifecycle information?

Click below to explore more details on WIN SOURCE:

 [View FOD617A3S](#) on WIN SOURCE

 [ON Semiconductor](#) Information

## Optimize Your Supply Chain with WIN SOURCE Solutions

-  Global Sourcing Solution
-  Obsolete Management
-  Cost Control Management
-  Shortage Management
-  Alternative Solution
-  Excess Inventory Management