





**THE DATASHEET OF
FH39-51S-0.3SHW(10)**



APPLICABLE STANDARD					
RATING	OPERATING TEMPERATURE RANGE	-55°C TO +85°C	STORAGE TEMPERATURE RANGE	-10°C TO +50°C(PACKED CONDITION)	
	VOLTAGE	30V AC/DC	OPERATING OR STORAGE HUMIDITY RANGE	RELATIVE HUMIDITY 90%MAX(NOT DEWED)	
	CURRENT	0.2A	APPLICABLE CABLE	t=0.2±0.03mm, GOLD PLATED	
SPECIFICATIONS					
ITEM	TEST METHOD		REQUIREMENTS	QT	AT
CONSTRUCTION					
GENERAL EXAMINATION	VISUALLY AND BY MEASURING INSTRUMENT.		ACCORDING TO DRAWING.	×	×
MARKING	CONFIRMED VISUALLY.			×	×
ELECTRIC CHARACTERISTICS					
VOLTAGE PROOF	90V AC FOR 1 min.		NO FLASHOVER OR BREAKDOWN.	×	×
INSULATION RESISTANCE	100V DC.		50MΩ MIN.	×	×
CONTACT RESISTANCE	AC 20mV MAX (1KHz), 1mA.		100mΩ MAX. INCLUDING FPC BULK RESISTANCE (L=12mm)	×	×
MECHANICAL CHARACTERISTICS					
VIBRATION	FREQUENCY 10 TO 55 Hz, HALF AMPLITUDE 0.75 mm FOR 10 CYCLES IN 3 DIRECTIONS.		① NO ELECTRICAL DISCONTINUITY OF 1 μs. ② CONTACT RESISTANCE: 100mΩ MAX. ③ NO DAMAGE, CRACK AND LOOSENESS OF PARTS.	×	—
SHOCK	981 m/s ² , DURATION OF PULSE 6ms AT 3 TIMES IN 3 DIRECTIONS.			×	—
MECHANICAL OPERATION	10 TIMES INSERTIONS AND EXTRACTIONS.		① CONTACT RESISTANCE: 100mΩ MAX. ② NO DAMAGE, CRACK AND LOOSENESS OF PARTS.	×	—
FPC RETENSION FORCE	MEASURED BY APPLICABLE FPC. (THICKNESS OF FPC SHALL BE t=0.20mm AT INITIAL CONDITION.)		DIRECTION OF INSERTION: 0.15N × NUMBER OF CONTACTS MIN. (note 1)	×	—
ENVIRONMENTAL CHARACTERISTICS					
CORROSION SALT MIST	EXPOSED AT 35±2°C, 5% SALT WATER SPRAY FOR 96h.		① CONTACT RESISTANCE: 100mΩ MAX. ② NO DAMAGE, CRACK AND LOOSENESS OF PARTS. ③ NO EVIDENCE OF CORROSION WHICH AFFECTS TO OPERATION OF CONNECTOR.	×	—
RAPID CHANGE OF TEMPERATURE	TEMPERATURE -55→+15 TO +35→+85→+15 TO +35 °C TIME 30 → 2~3 → 30 → 2~3 min UNDER 5 CYCLES.			×	—
DAMP HEAT (STEADY STATE)	EXPOSED AT 40±2°C, RELATIVE HUMIDITY 90 TO 95%, 96h.		① CONTACT RESISTANCE: 100mΩ MAX. ② INSULATION RESISTANCE: 50MΩ MIN. ③ NO DAMAGE, CRACK AND LOOSENESS OF PARTS.	×	—
DAMP HEAT,CYCLIC	EXPOSED AT -10 TO +65 °C RELATIVE HUMIDITY 90 TO 96 % 10 CYCLES, TOTAL 240h.			×	—
	COUNT	DESCRIPTION OF REVISIONS	DESIGNED	CHECKED	DATE
REMARK			APPROVED	MO.ISHIDA	08.07.07
			CHECKED	NM.NISHIMATSU	08.07.07
			DESIGNED	SU.SUNAGA	08.07.04
Unless otherwise specified, refer to JIS C 5402.			DRAWN	SU.SUNAGA	08.07.04
Note QT:Qualification Test AT:Assurance Test X:Applicable Test			DRAWING NO.		ELC4-157632-00
HRS	SPECIFICATION SHEET		PART NO.	FH39-**S-0.3SHW	
	HIROSE ELECTRIC CO., LTD.		CODE NO.	CL580	 1/2

SPECIFICATIONS					
ITEM	TEST METHOD	REQUIREMENTS	QT	AT	
DRY HEAT	EXPOSED AT $85 \pm 2^{\circ}\text{C}$, 96h.	① CONTACT RESISTANCE: $100\text{m}\Omega$ MAX. ② NO DAMAGE, CRACK AND LOOSENESS OF PARTS.	X	—	
COLD	EXPOSED AT $-55 \pm 3^{\circ}\text{C}$, 96h.				
SURPHUR DIOXIDE [JIS C 0090]	EXPOSED AT $40 \pm 2^{\circ}\text{C}$, RELATIVE HUMIDITY $80 \pm 5\%$, 25 ± 5 ppm FOR 96h.	① CONTACT RESISTANCE: $100\text{m}\Omega$ MAX. ② NO DAMAGE, CRACK AND LOOSENESS OF PARTS. ③ NO EVIDENCE OF CORROSION WHICH AFFECTS TO OPERATION OF CONNECTOR.	X	—	
HYDROGEN SULPHIDE [JIS C 0092]	EXPOSED AT $40 \pm 2^{\circ}\text{C}$, RELATIVE HUMIDITY $80 \pm 5\%$, 10 TO 15 ppm FOR 96h.				
SOLDERABILITY	SOLDERED AT SOLDER TEMPERATURE, $235 \pm 5^{\circ}\text{C}$ FOR IMMERSION DURATION, 2 ± 0.5 sec.	A NEW UNIFORM COATING OF SOLDER SHALL COVER A MINIMUM OF 95 % OF THE SURFACE BEING IMMersed.	X	—	
RESISTANCE TO SOLDERING HEAT	1) REFLOW SOLDERING: PEAK TMP. 250°C MAX. REFLOW TMP. 230°C MIN WITHIN 60 sec. 2) SOLDERING IRONS: TMP. $350 \pm 10^{\circ}\text{C}$ FOR 5 ± 1 sec.	NO DEFORMATION OF CASE OF EXCESSIVE LOOSENESS OF THE TERMINALS.	X	—	
<p>(note1)</p> <p>IF PULL FORCE IN VERTICAL DIRECTION COULD BE APPLIED TO THE FPC, SECURE THE FPC TO PCB OR SOMETHING FIXED.</p> <p>DO NOT CLOSE THE ACTUATOR BEFORE INSERTING FPC EVEN AFTER THE CONNECTOR IS MOUNTED ONTO A PCB. CLOSING THE ACTUATOR WITHOUT FPC COULD MAKE THE CONTACT GAP SMALLER, WHICH INCREASES THE FPC INSERTION FORCE.</p> <p>THIS CONNECTOR HAS CONTACT POINTS ON BOTH TOP AND BOTTOM.</p>					
Note QT:Qualification Test AT:Assurance Test X:Applicable Test			DRAWING NO.		ELC4-157632-00
HRS	SPECIFICATION SHEET		PART NO.	FH39-**-S-0.3SHW	
	HIROSE ELECTRIC CO., LTD.		CODE NO.	CL580	 2/2

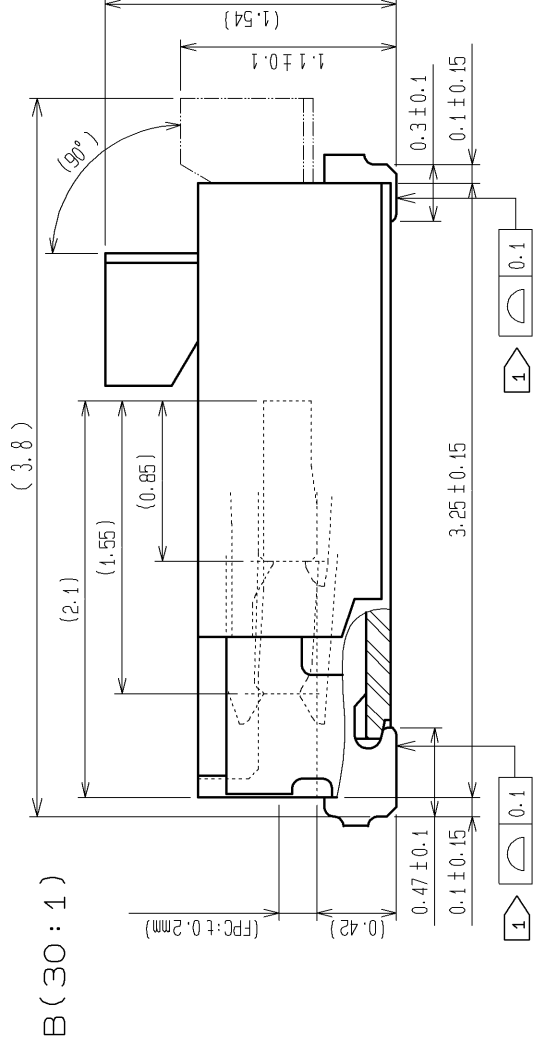
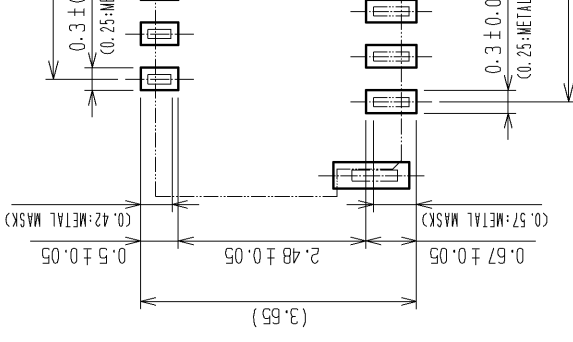
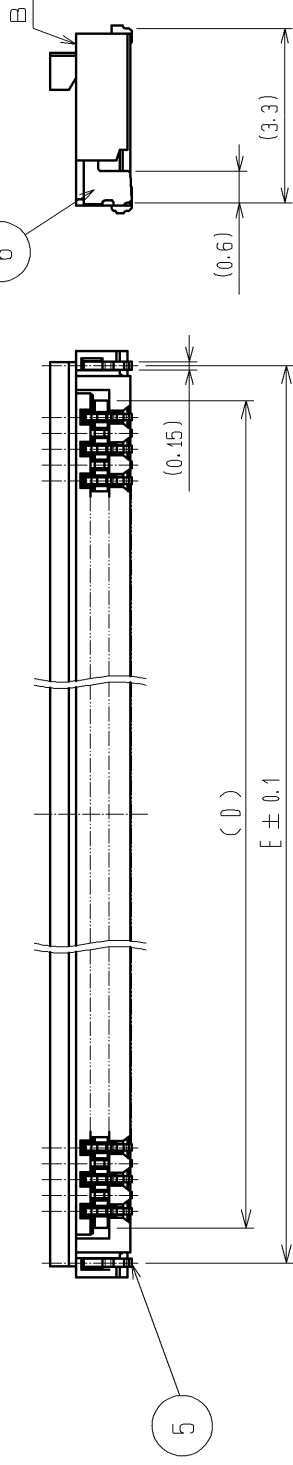
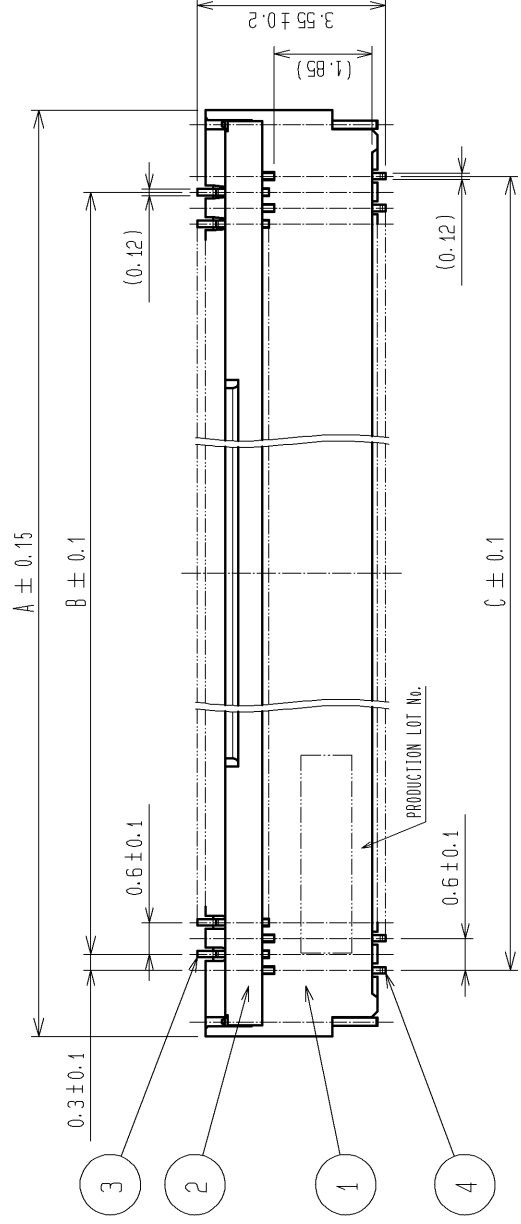

- NOTE
- LEAD CO-PLANARITY INCLUDING REINFORCED METAL FITTINGS SHALL BE 0.1 MAX.
 - TO BE DELIVERED WITH TAPE AND REEL PACKAGES. SEE ATTACHED PACKAGING SPECIFICATIONS FOR DETAILS.
 - NOTE THAT PREVENTIVE HOLE FOR SINK MARK COULD BE ADDED FOR IMPROVEMENT. THE QUALITY REMAINS GOOD, EVEN WITH THE DARK SPOTS, WHICH COULD OCCASIONALLY OCCUR ON MOLDED PLASTIC.

4	PHOSPHOR BRONZE	(CONTACT AREA- LEAD)	(OTHER) NICKEL PLATING
3	PHOSPHOR BRONZE	(CONTACT AREA- LEAD)	(OTHER) NICKEL PLATING
2	PA	BLACK	UL94V-C
1	LCP	BEIGE	UL94V-C
NO.		MATERIAL	
UNITS		FINISH	
mm			
SCALE		7 : 1	
COUN		5	
APPROVED		:RI. TA	
CHECKED		:NM. NI	
DESIGNED		:SU. SU	
DRAWN		:SU. SU	

HRS

HIROSE
ELECTRIC
CO., LTD.

RECOMMENDED FPC (SCALE:FREE)

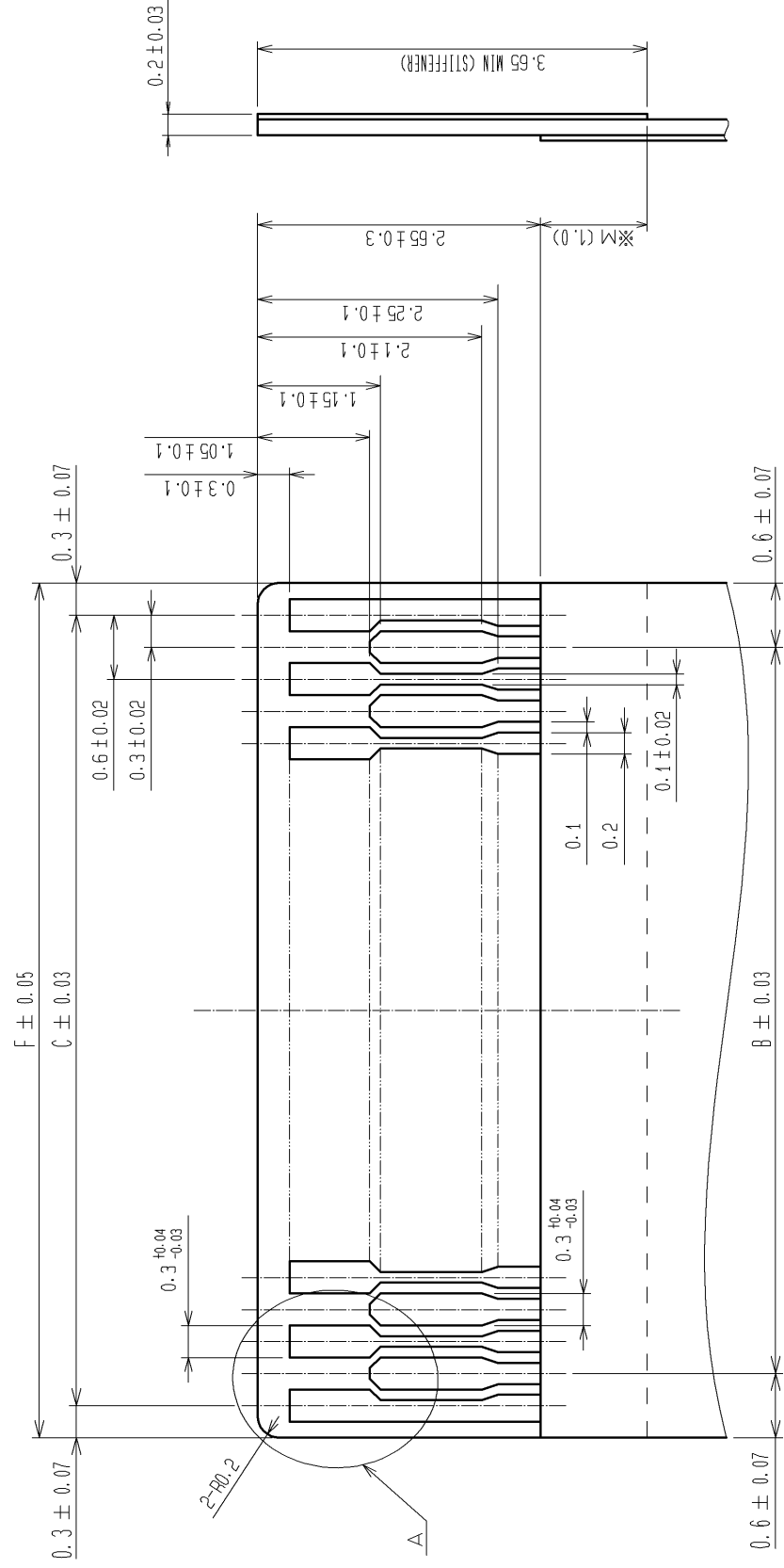

* Dimension M must be 0.5mm minimum when the stiffener is shorter than 3.65mm.

FPC CONSTRUCTION Recommended Specifications

MATERIAL NAME	MATERIAL	THICKNESS(μm)
COVERING FILM LAYER.	POLYIMIDE 1mil thick.	25
COVER ADHESIVE		25
SURFACE TREATMENT	1μm to 5μm NICKEL UNDERPLATED 0.2μm GOLD PLATED	(5)
COPPER FOIL	Cu 1 OZ	35
BASE ADHESIVE	HEAT-HARDENED ADHESIVE	25
BASE FILM	POLYIMIDE 1mil thick	25
REINFORCEMENT MATERIAL ADHESIVE	HEAT-HARDENED ADHESIVE	40
STIFFENER	POLYIMIDE 3mil thick	75

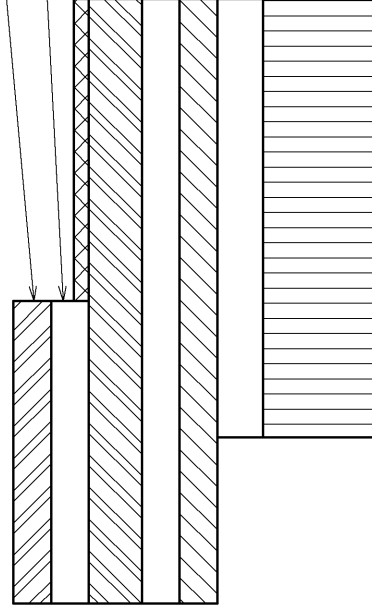

24mm MAX

(2.1)

(0.3)

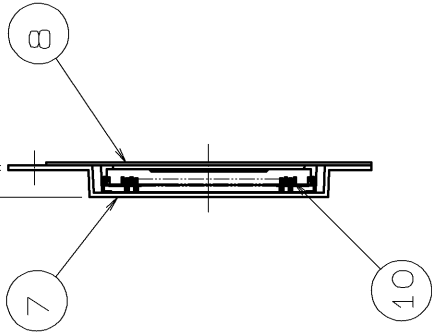

32mm MIN

(2.1)

(0.3)

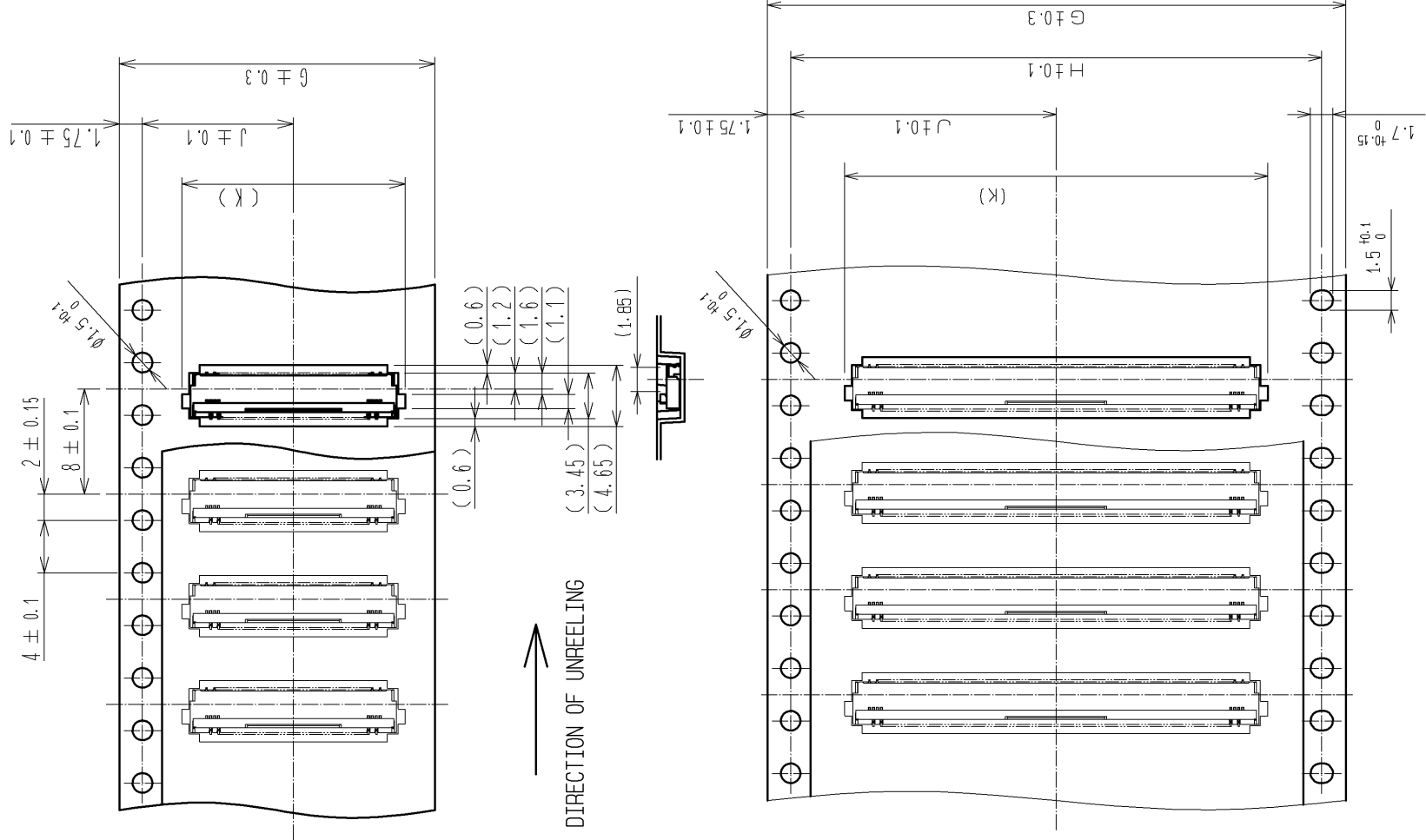
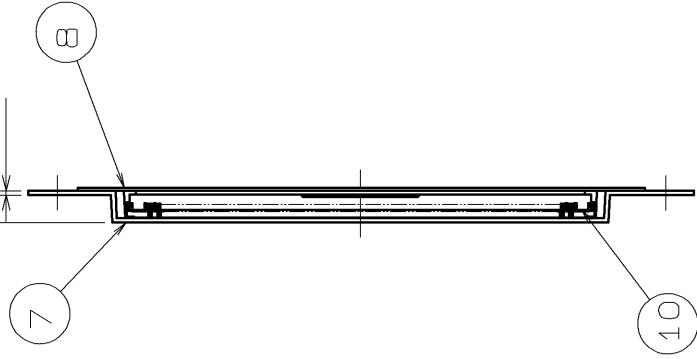

REEL

9

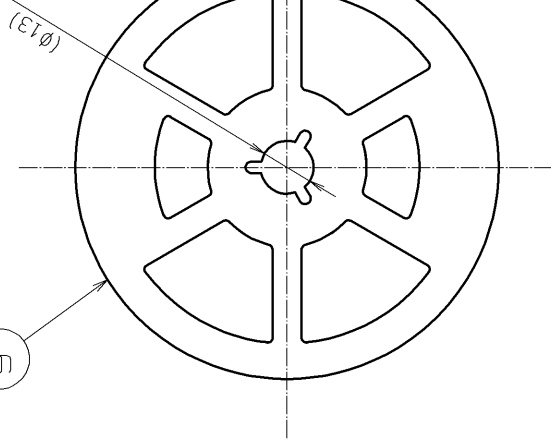

NOTE 4 THE DIMENS
 5 PER REEL :
 6 REFER TO J
 (PACKAGING C

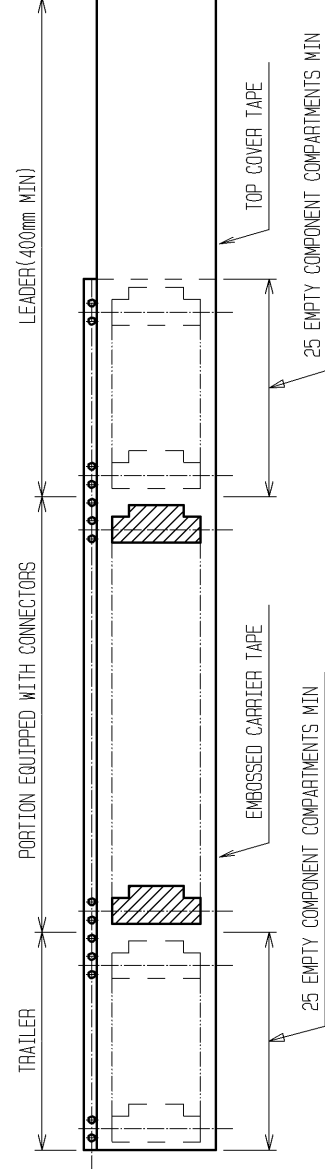

PART NUMBER	CODE NUMBER	NUMBER OF CONTACT	DIMENSION OF CONNECTOR, FPC, LAND PATTERN AND METAL MASK					
			A	B	C	D	E	F
FH39-25S-0.3SHW(10)	CL580-1806-8-10	25	9.7	6.6	7.2	7.83	9.15	7.8
FH39-27S-0.3SHW(10)	CL580-1805-5-10	27	10.3	7.2	7.8	8.43	9.75	8.4
FH39-29S-0.3SHW(10)	CL580-1807-0-10	29	10.9	7.8	8.4	9.03	10.35	9
FH39-33S-0.3SHW(10)	CL580-1803-0-10	33	12.1	9	9.6	10.23	11.55	10.2
FH39-39S-0.3SHW(10)	CL580-1800-1-10	39	13.9	10.8	11.4	12.03	13.35	12
FH39-45S-0.3SHW(10)	CL580-1802-7-10	45	15.7	12.6	13.2	13.83	15.15	13.8
FH39-51S-0.3SHW(10)	CL580-1801-4-10	51	17.5	14.4	15	15.63	16.95	15.6

△ DELETION

This connector features small, thin and back flip design, requiring delicate and careful handling.
Read through the instructions shown below and handle the connector properly.

[Operation and Precautions]

1. Initial condition

Actuator does not have to be operated before inserting FPC, as the connector is delivered with the actuator opened. [See Fig.1]

[Caution]

- Do not close the actuator before inserting FPC.
- Closing the actuator without FPC could make the contact gap smaller, which could increase the FPC insertion force. [See Fig.2]

[Fig. 1]

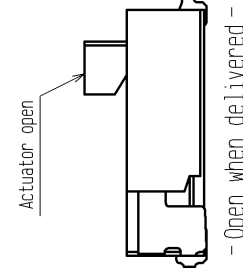

[Fig. 2]

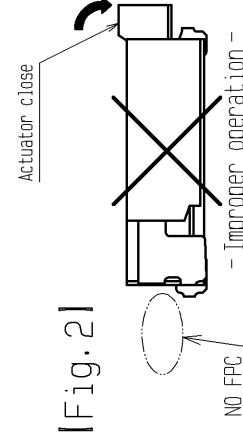

2. How to insert FPC

Insert the FPC into the connector opening horizontally to the board plane.
Insert it properly to the very end.

[Caution]

- Insert the FPC with the actuator opened. [See Fig.3, Fig.4]
- Twisting the FPC to up and down, right and left or an angle could cause contact deformation and contact failure.

[Fig. 3]

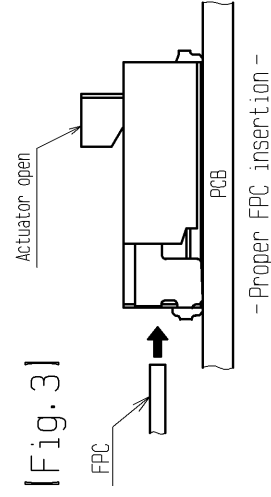

[Fig. 4]

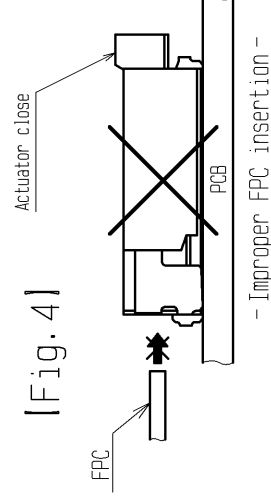

3. How to lock

Apply load to rotate the actuator by 90 degree after inserting the FPC. [See Fig.5]

[Fig. 5]

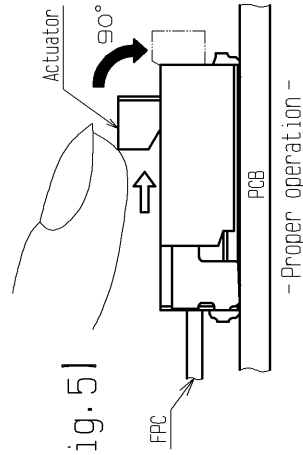

[Fig. 6]

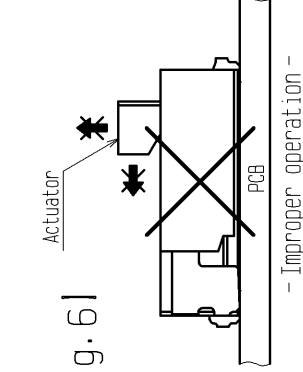

[Caution]

- The actuator rotates around the rotational axis. [See Fig.7]
- Do not rotate the actuator to the counter direction.
- Do not pinch or pick the actuator to lift. Otherwise, it may be damaged.
- Apply load to the mid-point on the actuator to rotate it.
- Do not apply excess force to the housing during the operation.

[Prohibited acts]

- Do not operate the side end of the actuator, or it may be damaged.
- Please operate both ends at the same time when you close the actuator and cause half mating.

[Fig. 7]

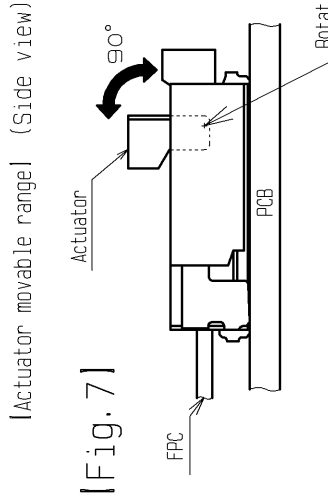

4. How to remove FPC (How to unlock)

Slowly flip up the actuator to release the lock and remove the FPC.

[Caution]

- The actuator is opened up to the movable limit, 90 degrees. Do not open the actuator beyond the specified degree, or it may be damaged.
- To open the actuator, operate at the mid-point of the actuator.
- Please note that the connector is back flip style connector and the opening for FPC insertion and the actuator flip up are in the opposite direction. Do not try to lift the actuator from the insertion opening side. [See Fig.10]

[Prohibited acts]

- Do not lift up the side end of the actuator, or it may be damaged.
- Please operate both ends at the same time when you close the actuator and cause breakage.

[Prohibited acts]

- Do not pull out the FPC with the actuator locked.
- When FPC is pulled out with the actuator locked, it causes the contact deformation and contact failure.

This connector features small, thin and back flip design, requiring delicate and careful handling. Read through the instructions shown below and handle the connector properly.

[Instructions for mounting on the board]

1. Warp of board
 - Minimize warp of the board as much as possible.
 - Lead co-planarity including reinforced metal fittings is 0.1 mm or less.
 - Too much warp of the board may result in a soldering failure.
2. Load to connector
 - Do not apply mechanical stress to the connector before mounting on the board.
 - Otherwise, the connector may be broken.
 - Do not insert the FPC or operate the connector before mounting.
3. Load to board
 - Splitting a large board into several pieces
 - Screwing the board
 - Avoid the handling described above so that no force is applied on the board during the assembly process.
 - Otherwise, the connector may become defective.
4. Reflow temperature profile
 - Apply reflow temperature profile within the specified conditions.
 - In individual applications, the actual temperature may vary, depending on solder paste type, volume/thickness and board size/thickness.
 - Consult your solder paste and equipment manufacturer for specific recommendations.
5. Amount of bend of board
 - The bend of a 100-mm wide board should be 1 mm or less. [See Fig. 11]
 - The bend of board could apply stress on the connector and it may become defective.

[Fig. 11]

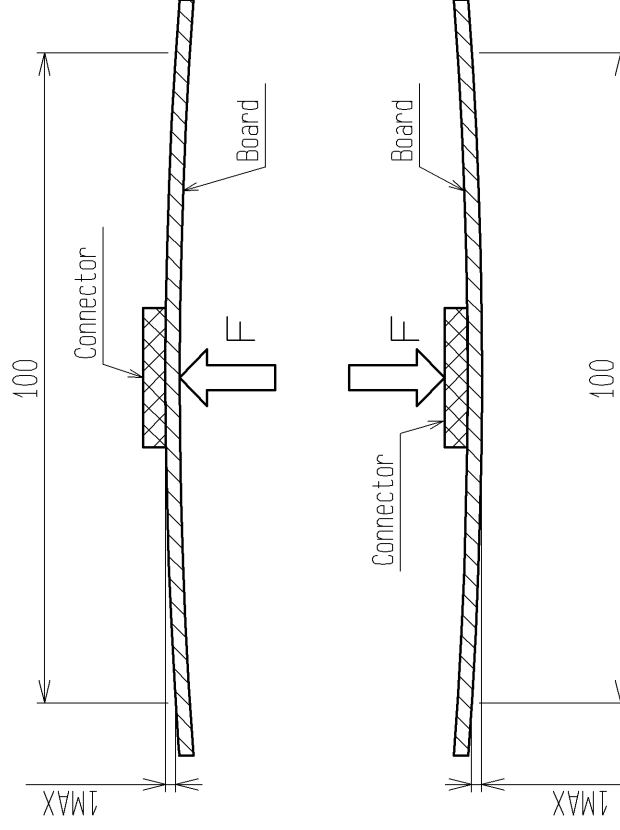

[Precautions for design]

1. During FPC wiring, ensure that stress is not applied to the FPC. Do not bend the FPC excessively near the connector. Contact failure or FPC breakage. Stabilizing the FPC is recommended.
2. Keep a sufficient FPC insertion space. Do not perform manual soldering with incorrect FPC insertion. Appropriate FPC length and component placement. Too short FPC length makes assembly difficult.
3. Follow the recommended PCB layout.
4. Make adjustments with the FPC manual.
5. Keep spaces for the actuator movement.

[Other instructions]

1. Instructions on manual soldering
 - Follow the instructions shown below.
- [Prohibited acts]
1. Do not perform manual soldering with excessive heat.
 2. Do not heat the connector excessively. Be very careful not to let the solder flow. Otherwise, the connector may be damaged.
 3. Do not apply excessive solder (or flux) to the connector. If excessive solder (or flux) is applied to the connector or rotating parts of the actuator, supplying excessive solder to the connector may result in breakage of the connector.

Looking for pricing, stock, or lifecycle information?

Click below to explore more details on WIN SOURCE:

- [View FH39-51S-0.3SHW\(10\) on WIN SOURCE](#)
- [Hirose Electric Co Ltd Information](#)

Optimize Your Supply Chain with WIN SOURCE Solutions

- ✓ Global Sourcing Solution
- ✓ Obsolete Management
- ✓ Cost Control Management
- ✓ Shortage Management
- ✓ Alternative Solution
- ✓ Excess Inventory Management