

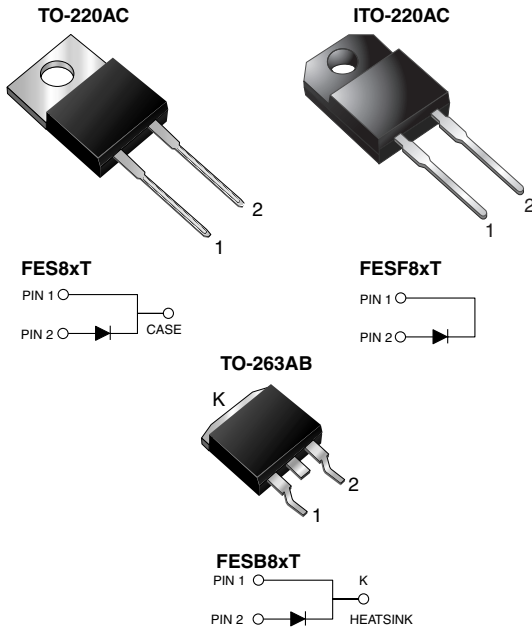

**THE DATASHEET OF  
FESB8JTHE3\_A/I**



## Ultrafast Plastic Rectifier



### FEATURES

- Glass passivated chip junction
- Ultrafast recovery time
- Low switching losses, high efficiency
- Low leakage current
- High forward surge capability
- Meets MSL level 1, per J-STD-020, LF maximum peak of 245 °C (for TO-263AB package)
- Solder dip 260 °C, 40 s (for TO-220AC and ITO-220AC package)
- Component in accordance to RoHS 2002/95/EC and WEEE 2002/96/EC



**RoHS**  
COMPLIANT

### TYPICAL APPLICATIONS

For use in high frequency rectifier of switching mode power supplies, inverters, freewheeling diodes, dc-to-dc converters, and other power switching application.

### MECHANICAL DATA

**Case:** TO-220AC, ITO-220AC, TO-263AB

Epoxy meets UL 94V-0 flammability rating

**Terminals:** Matte tin plated leads, solderable per J-STD-002 and JESD22-B102

E3 suffix for consumer grade, meets JESD 201 class 1A whisker test, HE3 suffix for high reliability grade (AEC Q101 qualified), meets JESD 201 class 2 whisker test

**Polarity:** As marked

**Mounting Torque:** 10 in-lbs maximum

### PRIMARY CHARACTERISTICS

$I_{F(AV)}$	8.0 A
$V_{RRM}$	50 V to 600 V
$I_{FSM}$	125 A
$t_{tr}$	35 ns, 50 ns
$V_F$	0.95 V, 1.30 V, 1.50 V
$T_J$ max.	150 °C

### MAXIMUM RATINGS ( $T_C = 25$ °C unless otherwise noted)

PARAMETER	SYMBOL	FES 8AT	FES 8BT	FES 8CT	FES 8DT	FES 8FT	FES 8GT	FES 8HT	FES 8JT	UNIT
Maximum repetitive peak reverse voltage	$V_{RRM}$	50	100	150	200	300	400	500	600	V
Maximum RMS voltage	$V_{RMS}$	35	70	105	140	210	280	350	420	V
Maximum DC blocking voltage	$V_{DC}$	50	100	150	200	300	400	500	600	V
Maximum average forward rectified current at $T_C = 100$ °C	$I_{F(AV)}$	8.0								A
Peak forward surge current 8.3 ms single half sine-wave superimposed on rated load	$I_{FSM}$	125								A
Operating storage and temperature range	$T_J, T_{STG}$	- 55 to + 150								°C
Isolation voltage (ITO-220AC only) from terminal to heatsink $t = 1$ min	$V_{AC}$	1500								V

# FES(F,B)8AT thru FES(F,B)8JT

Vishay General Semiconductor



<b>ELECTRICAL CHARACTERISTICS</b> ( $T_C = 25\text{ }^\circ\text{C}$ unless otherwise noted)												
PARAMETER	TEST CONDITIONS		SYMBOL	FES 8AT	FES 8BT	FES 8CT	FES 8DT	FES 8FT	FES 8GT	FES 8HT	FES 8JT	UNIT
Maximum instantaneous forward voltage <sup>(1)</sup>	8.0 A		$V_F$	0.95			1.3		1.5			V
Maximum DC reverse current at rated DC blocking voltage		$T_C = 25\text{ }^\circ\text{C}$ $T_C = 100\text{ }^\circ\text{C}$	$I_R$	10 500								$\mu\text{A}$
Maximum reverse recovery time	$I_F = 0.5\text{ A}$ , $I_R = 1.0\text{ A}$ , $I_{rr} = 0.25\text{ A}$		$t_{rr}$	35			50				ns	
Typical junction capacitance	4.0 V, 1 MHz		$C_J$	85					50			pF

**Note:**

(1) Pulse test: 300  $\mu\text{s}$  pulse width, 1 % duty cycle

<b>THERMAL CHARACTERISTICS</b> ( $T_C = 25\text{ }^\circ\text{C}$ unless otherwise noted)					
PARAMETER	SYMBOL	FES	FESF	FESB	UNIT
Typical thermal resistance from junction to case	$R_{\theta JC}$	2.2	5.0	2.2	$^\circ\text{C/W}$

<b>ORDERING INFORMATION</b> (Example)					
PACKAGE	PREFERRED P/N	UNIT WEIGHT (g)	PACKAGE CODE	BASE QUANTITY	DELIVERY MODE
TO-220AC	FES8JT-E3/45	1.80	45	50/tube	Tube
ITO-220AC	FESF8JT-E3/45	1.85	45	50/tube	Tube
TO-263AB	FESB8JT-E3/45	1.33	45	50/tube	Tube
TO-263AB	FESB8JT-E3/81	1.33	81	800/reel	Tape and reel
TO-220AC	FES8JT-E3/45 <sup>(1)</sup>	1.80	45	50/tube	Tube
ITO-220AC	FESF8JT-E3/45 <sup>(1)</sup>	1.85	45	50/tube	Tube
TO-263AB	FESB8JT-E3/45 <sup>(1)</sup>	1.33	45	50/tube	Tube
TO-263AB	FESB8JT-E3/81 <sup>(1)</sup>	1.33	81	800/reel	Tape and reel

**Note:**

(1) Automotive grade AEC Q101 qualified

## RATINGS AND CHARACTERISTICS CURVES

( $T_A = 25\text{ }^\circ\text{C}$  unless otherwise noted)

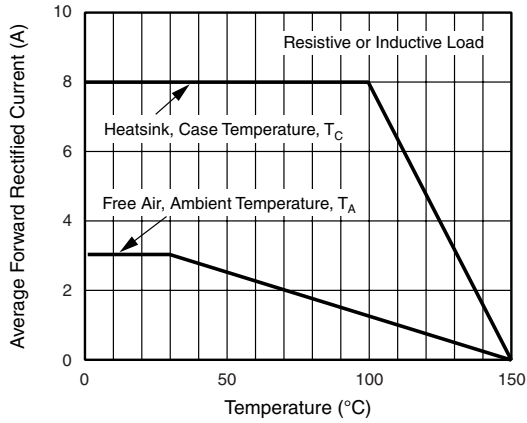

Figure 1. Maximum Forward Current Derating Curve

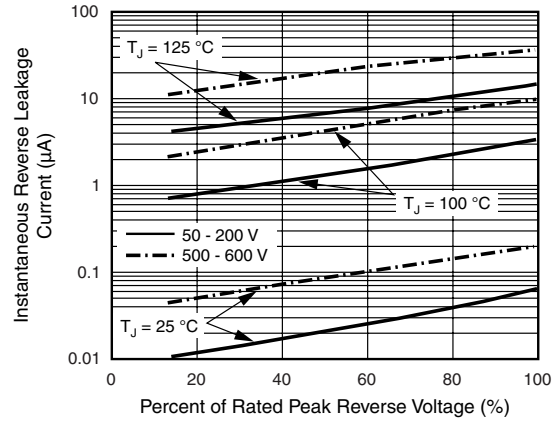

Figure 4. Typical Reverse Leakage Characteristics

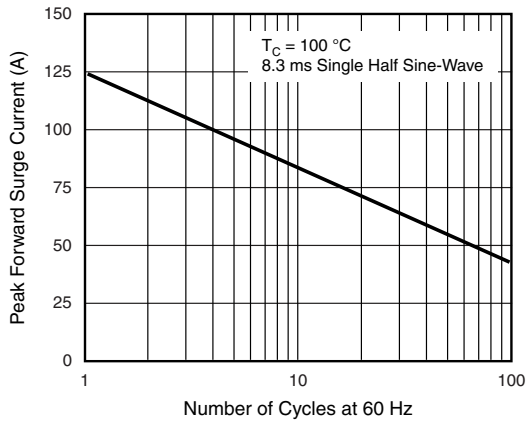

Figure 2. Maximum Non-Repetitive Peak Forward Surge Current

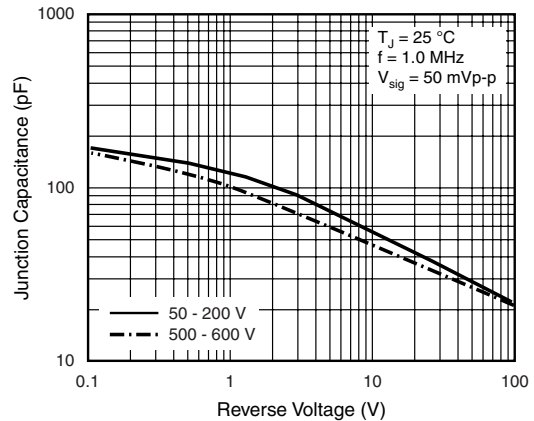

Figure 5. Typical Junction Capacitance

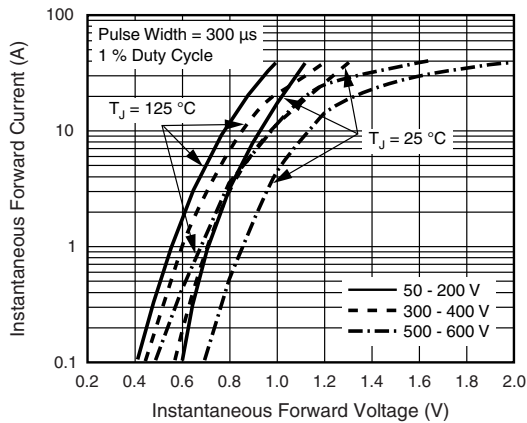
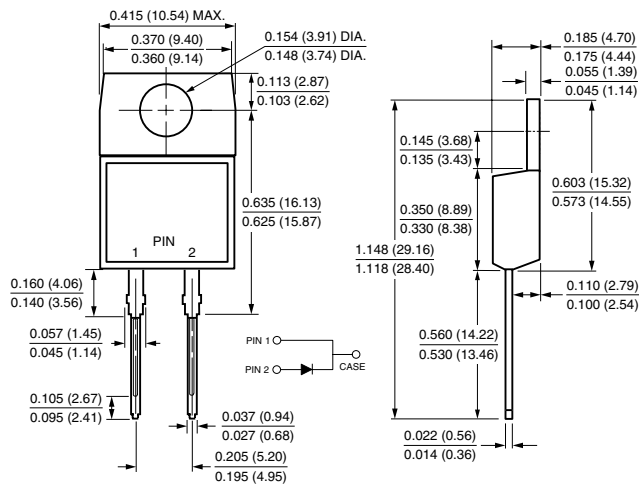

Figure 3. Typical Instantaneous Forward Characteristics

## PACKAGE OUTLINE DIMENSIONS in inches (millimeters)

**TO-220AC**



**ITO-220AC**

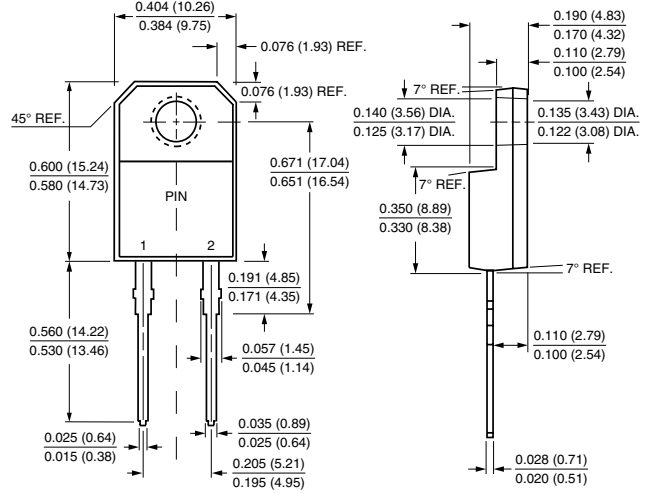

**TO-263AB**

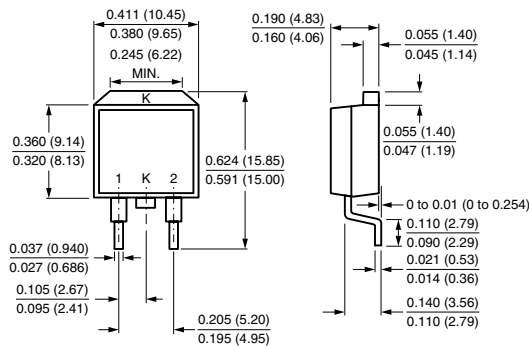

**Mounting Pad Layout**

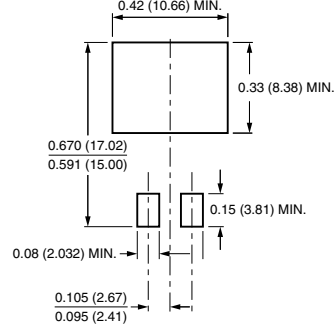



## Disclaimer

ALL PRODUCT, PRODUCT SPECIFICATIONS AND DATA ARE SUBJECT TO CHANGE WITHOUT NOTICE TO IMPROVE RELIABILITY, FUNCTION OR DESIGN OR OTHERWISE.

Vishay Intertechnology, Inc., its affiliates, agents, and employees, and all persons acting on its or their behalf (collectively, "Vishay"), disclaim any and all liability for any errors, inaccuracies or incompleteness contained in any datasheet or in any other disclosure relating to any product.

Vishay makes no warranty, representation or guarantee regarding the suitability of the products for any particular purpose or the continuing production of any product. To the maximum extent permitted by applicable law, Vishay disclaims (i) any and all liability arising out of the application or use of any product, (ii) any and all liability, including without limitation special, consequential or incidental damages, and (iii) any and all implied warranties, including warranties of fitness for particular purpose, non-infringement and merchantability.

Statements regarding the suitability of products for certain types of applications are based on Vishay's knowledge of typical requirements that are often placed on Vishay products in generic applications. Such statements are not binding statements about the suitability of products for a particular application. It is the customer's responsibility to validate that a particular product with the properties described in the product specification is suitable for use in a particular application. Parameters provided in datasheets and/or specifications may vary in different applications and performance may vary over time. All operating parameters, including typical parameters, must be validated for each customer application by the customer's technical experts. Product specifications do not expand or otherwise modify Vishay's terms and conditions of purchase, including but not limited to the warranty expressed therein.

Except as expressly indicated in writing, Vishay products are not designed for use in medical, life-saving, or life-sustaining applications or for any other application in which the failure of the Vishay product could result in personal injury or death. Customers using or selling Vishay products not expressly indicated for use in such applications do so at their own risk and agree to fully indemnify and hold Vishay and its distributors harmless from and against any and all claims, liabilities, expenses and damages arising or resulting in connection with such use or sale, including attorneys fees, even if such claim alleges that Vishay or its distributor was negligent regarding the design or manufacture of the part. Please contact authorized Vishay personnel to obtain written terms and conditions regarding products designed for such applications.

No license, express or implied, by estoppel or otherwise, to any intellectual property rights is granted by this document or by any conduct of Vishay. Product names and markings noted herein may be trademarks of their respective owners.

## Material Category Policy

**Vishay Intertechnology, Inc. hereby certifies that all its products that are identified as RoHS-Compliant fulfill the definitions and restrictions defined under Directive 2011/65/EU of The European Parliament and of the Council of June 8, 2011 on the restriction of the use of certain hazardous substances in electrical and electronic equipment (EEE) - recast, unless otherwise specified as non-compliant.**

**Please note that some Vishay documentation may still make reference to RoHS Directive 2002/95/EC. We confirm that all the products identified as being compliant to Directive 2002/95/EC conform to Directive 2011/65/EU.**

## Looking for pricing, stock, or lifecycle information?

Click below to explore more details on WIN SOURCE:

 [View FESB8JTHER3\\_A/I on WIN SOURCE](#)

 [Vishay Information](#)

## Optimize Your Supply Chain with WIN SOURCE Solutions

-  Global Sourcing Solution
-  Obsolete Management
-  Cost Control Management
-  Shortage Management
-  Alternative Solution
-  Excess Inventory Management