



**THE DATASHEET OF  
ESD5111FCT5G**



# ESD Protection Diodes

## Micro-packaged Diodes for ESD Protection

### ESD5101, ESD5111

The ESD51x1 Series is designed to protect voltage sensitive components from ESD. Excellent clamping capability, low leakage, and fast response time provide best in class protection on designs that are exposed to ESD. Because of its small size, it is suited for use in smartphone, smart-watch, or many other portable / wearable applications where board space comes at a premium.

#### Features

- Low Capacitance (5 pF Max, I/O to GND)
- Small Body Outline Dimensions
  - ◆ 01005 Size: 0.435 x 0.23 mm
  - ◆ 0201 Size: 0.6 x 0.3 mm
- Protection for the Following IEC Standards: IEC 61000-4-2 (Level 4)
- Low ESD Clamping Voltage
- These Devices are Pb-Free, Halogen Free/BFR Free and are RoHS Compliant

#### MAXIMUM RATINGS (T<sub>J</sub> = 25°C unless otherwise noted)

Rating	Symbol	Value	Unit
Operating Junction Temperature Range	T <sub>J</sub>	-55 to +125	°C
Storage Temperature Range	T <sub>stg</sub>	-55 to +150	°C
Lead Solder Temperature – Maximum (10 Seconds)	T <sub>L</sub>	260	°C
IEC 61000-4-2 Contact (ESD)	ESD	±15	kV
IEC 61000-4-2 Air (ESD)	ESD	±15	kV

Stresses exceeding those listed in the Maximum Ratings table may damage the device. If any of these limits are exceeded, device functionality should not be assumed, damage may occur and reliability may be affected.

See Application Note AND8308/D for further description of survivability specs.

#### MARKING DIAGRAMS

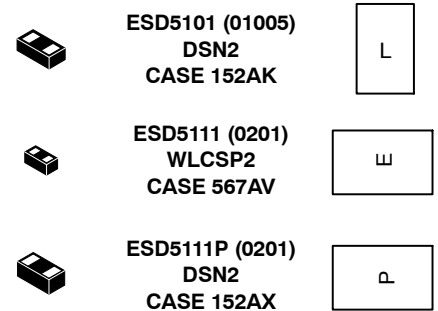

L, E, P = Device Code

#### PIN CONFIGURATION AND SCHEMATIC

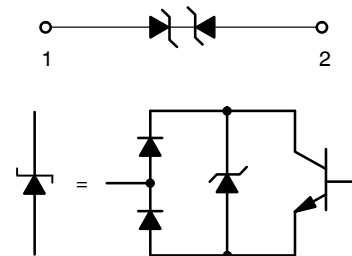

#### ORDERING INFORMATION

See detailed ordering and shipping information on page 2 of this data sheet.

# ESD5101, ESD5111

## ELECTRICAL CHARACTERISTICS (T<sub>A</sub> = 25°C unless otherwise specified)

Parameter	Symbol	Conditions	Min	Typ	Max	Unit
Reverse Working Voltage	V <sub>RWM</sub>	I/O Pin to GND			3.3	V
Breakdown Voltage	V <sub>BR</sub>	I <sub>T</sub> = 1 mA, I/O Pin to GND	3.68	5.0	6.5	V
Reverse Leakage Current	I <sub>R</sub>	V <sub>RWM</sub> = 3.3 V, I/O Pin to GND			0.1	μA
ESD5101, ESD5111 Clamping Voltage TLP (Note 1)	V <sub>C</sub>	I <sub>PP</sub> = 8 A } IEC 61000-4-2 Level 2 equivalent (±4 kV Contact, ±4 kV Air)		5.5		V
		I <sub>PP</sub> = 16 A } IEC 61000-4-2 Level 2 equivalent (±8 kV Contact, ±15 kV Air)		6.5		
Junction Capacitance	C <sub>J</sub>	V <sub>R</sub> = 0 V, f = 1 MHz			5.5	pF

Product parametric performance is indicated in the Electrical Characteristics for the listed test conditions, unless otherwise noted. Product performance may not be indicated by the Electrical Characteristics if operated under different conditions.

1. ANSI/ESD STM5.5.1 – Electrostatic Discharge Sensitivity Testing using Transmission Line Pulse (TLP) Model.

TLP conditions: Z<sub>0</sub> = 50 Ω, t<sub>p</sub> = 100 ns, t<sub>r</sub> = 4 ns, averaging window; t<sub>1</sub> = 30 ns to t<sub>2</sub> = 60 ns.

## ORDERING INFORMATION

Device	Package	Shipping <sup>†</sup>
ESD5101FCT5G	DSN2 (Pb-Free)	10,000 / Tape & Reel
ESD5111FCT5G	WLCSP2 (Pb-Free)	10,000 / Tape & Reel
ESD5111PFCT5G	DSN2 (Pb-Free)	10,000 / Tape & Reel

<sup>†</sup>For information on tape and reel specifications, including part orientation and tape sizes, please refer to our Tape and Reel Packaging Specifications Brochure, BRD8011/D.

# ESD5101, ESD5111

## TYPICAL CHARACTERISTICS

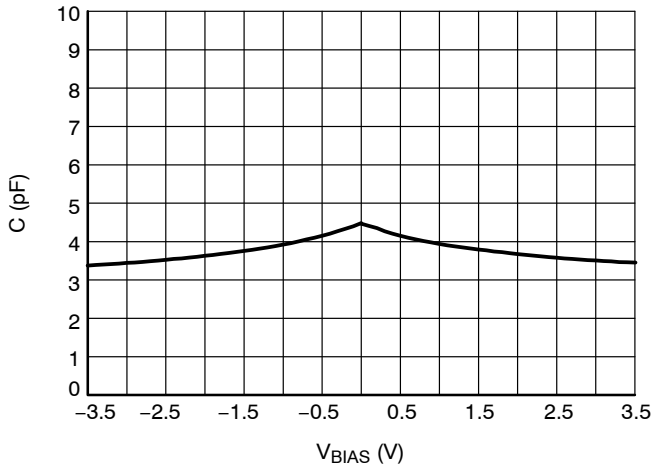

Figure 1. ESD5101 CV Characteristics

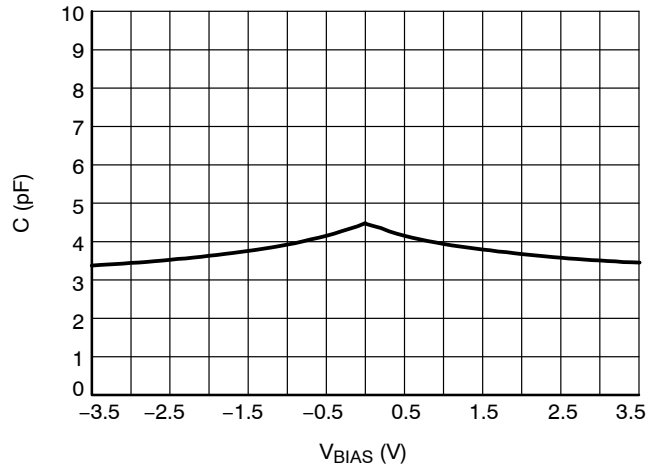

Figure 2. ESD5111 CV Characteristics

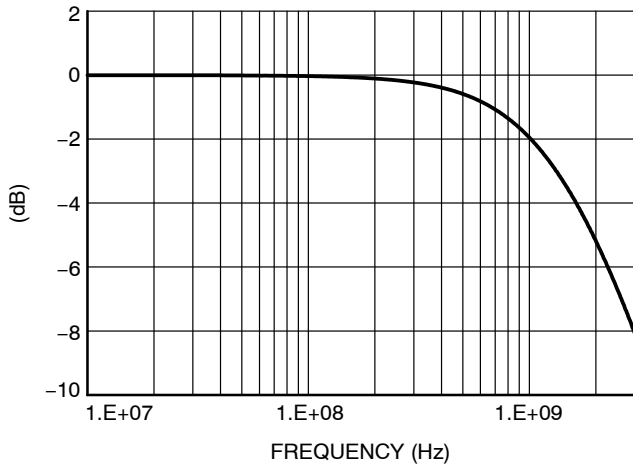

Figure 3. ESD5101 S21 Insertion Loss

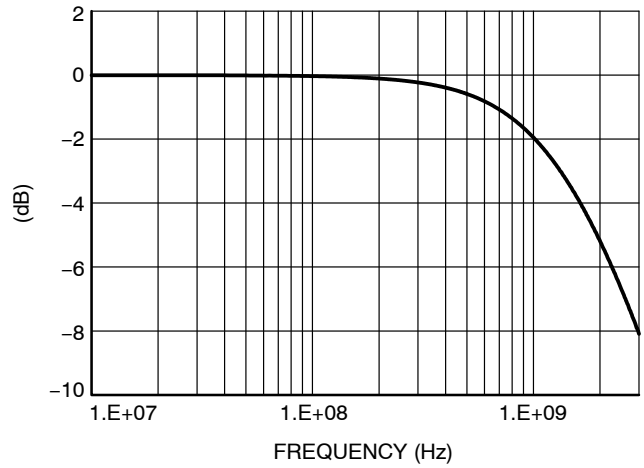

Figure 4. ESD5111 S21 Insertion Loss

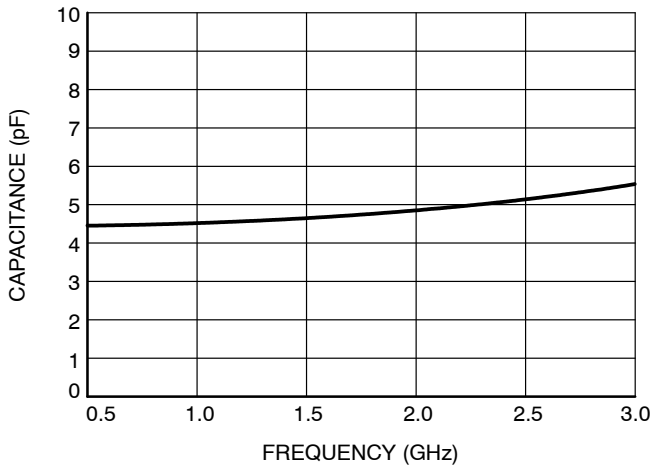

Figure 5. ESD5101 Capacitance over Frequency

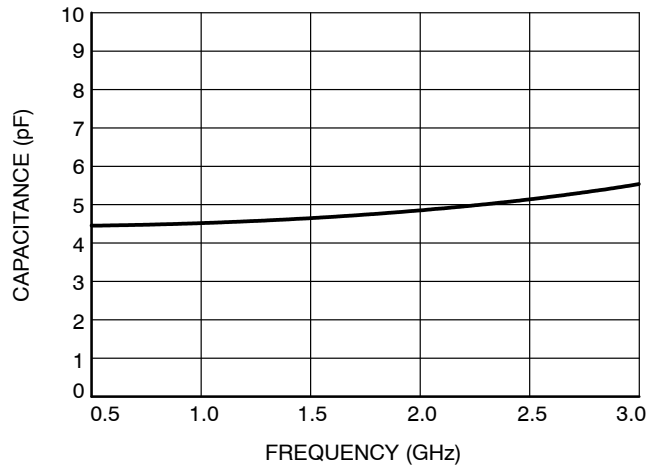

Figure 6. ESD5111 Capacitance over Frequency

# ESD5101, ESD5111

## TYPICAL CHARACTERISTICS

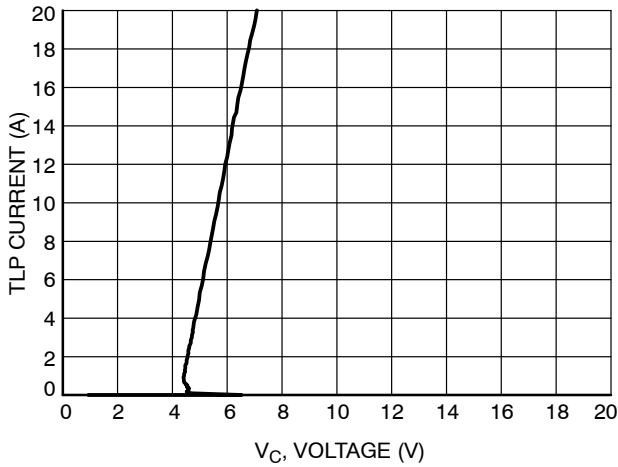

Figure 7. ESD5101 Positive TLP I-V Curve

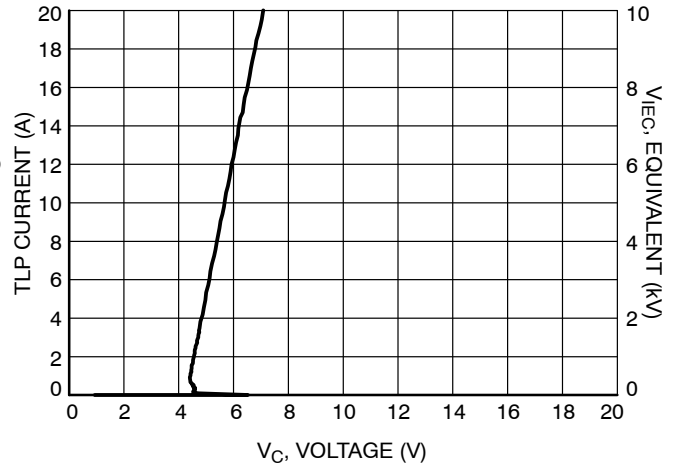

Figure 8. ESD5111 Positive TLP I-V Curve

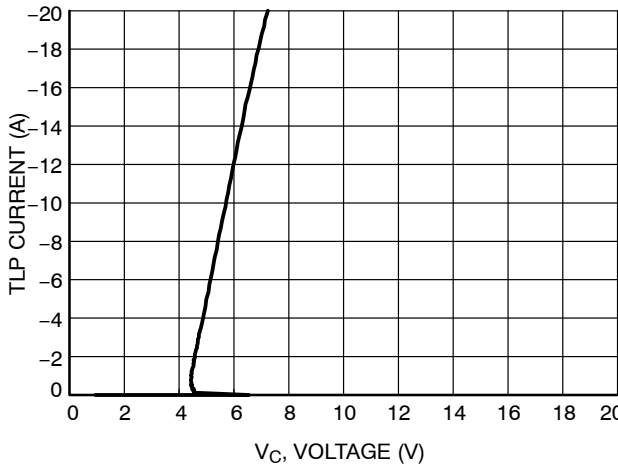

Figure 9. ESD5101 Negative TLP I-V Curve

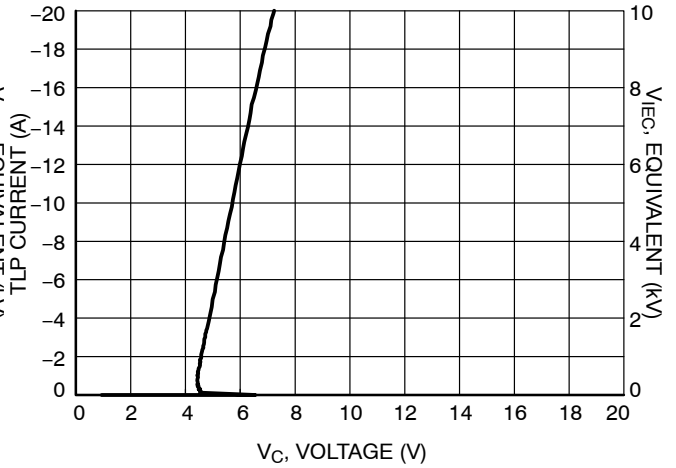

Figure 10. ESD5111 Negative TLP I-V Curve

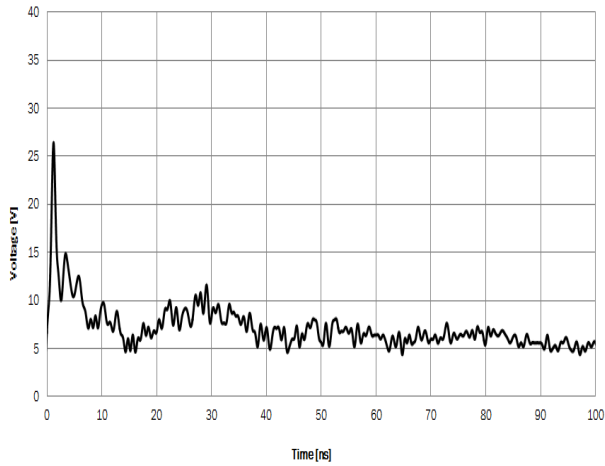

Figure 11. ESD5111 Positive 8 kV ESD Contact Discharge

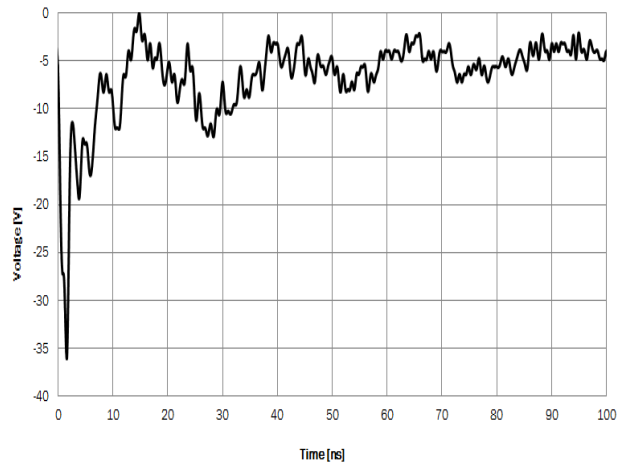

Figure 12. ESD5111 Negative 8 kV ESD Contact Discharge

# ESD5101, ESD5111

## IEC 61000-4-2 Spec.

Level	Test Voltage (kV)	First Peak Current (A)	Current at 30 ns (A)	Current at 60 ns (A)
1	2	7.5	4	2
2	4	15	8	4
3	6	22.5	12	6
4	8	30	16	8



Figure 13. IEC61000-4-2 Spec

## Transmission Line Pulse (TLP) Measurement

Transmission Line Pulse (TLP) provides current versus voltage (I-V) curves in which each data point is obtained from a 100 ns long rectangular pulse from a charged transmission line. A simplified schematic of a typical TLP system is shown in Figure 14. TLP I-V curves of ESD protection devices accurately demonstrate the product's ESD capability because the 10s of amps current levels and under 100 ns time scale match those of an ESD event. This is illustrated in Figure 15 where an 8 kV IEC 61000-4-2 current waveform is compared with TLP current pulses at 8 A and 16 A. A TLP I-V curve shows the voltage at which the device turns on as well as how well the device clamps voltage over a range of current levels.

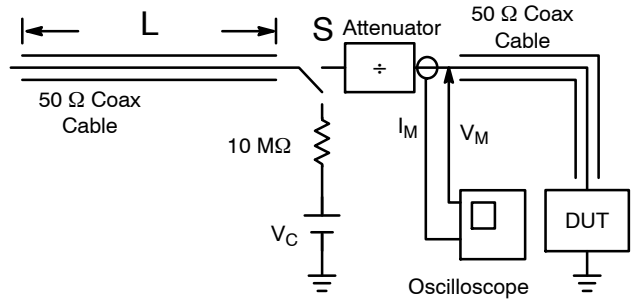

Figure 14. Simplified Schematic of a Typical TLP System

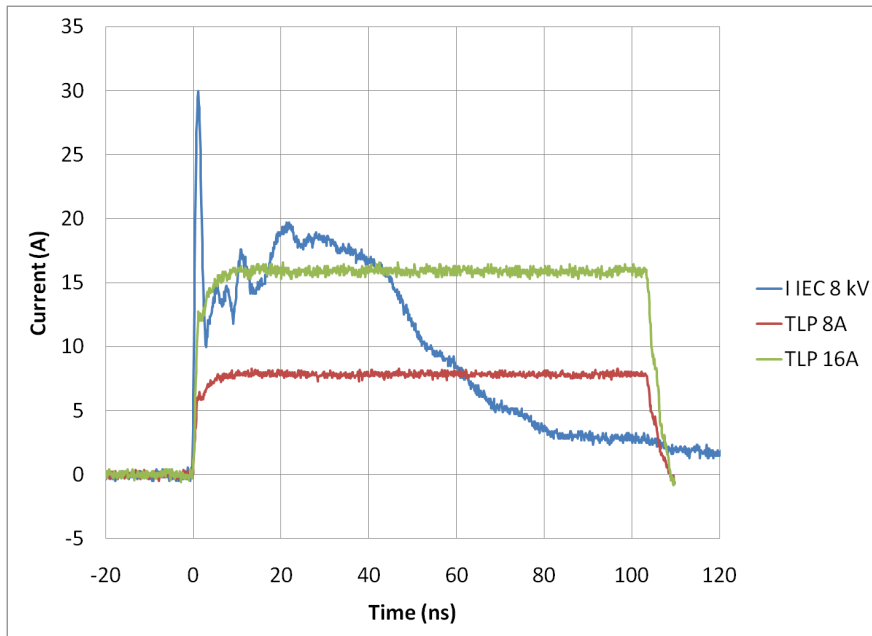

Figure 15. Comparison Between 8 kV IEC 61000-4-2 and 8 A and 16 A TLP Waveforms

# MECHANICAL CASE OUTLINE

## PACKAGE DIMENSIONS

ON Semiconductor®



SCALE 16:1

DSN2, 0.435x0.23, 0.27P, (01005)  
CASE 152AK  
ISSUE A

DATE 17 FEB 2015

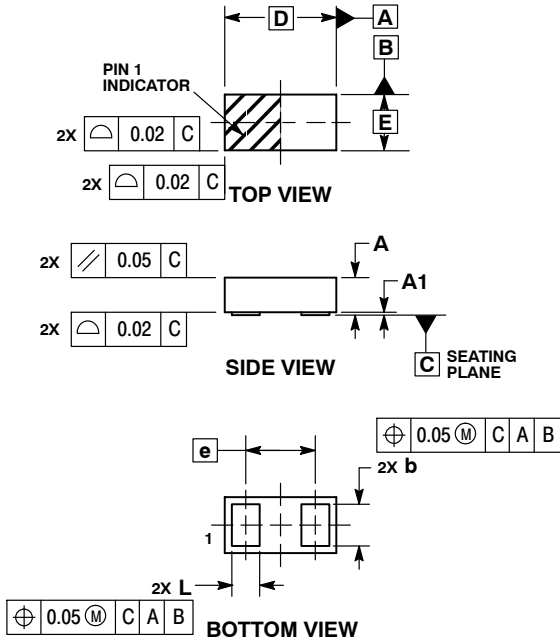

- NOTES:
1. DIMENSIONING AND TOLERANCING PER ASME Y14.5M, 1994.
  2. CONTROLLING DIMENSION: MILLIMETERS.

MILLIMETERS		
DIM	MIN	MAX
A	0.165	0.195
A1	---	0.030
b	0.177	0.193
D	0.435 BSC	
E	0.230 BSC	
e	0.270 BSC	
L	0.112	0.128

### GENERIC MARKING DIAGRAM\*



X = Specific Device Code  
 \*This information is generic. Please refer to device data sheet for actual part marking. Pb-Free indicator, "G", may or not be present.

### RECOMMENDED SOLDER FOOTPRINT\*

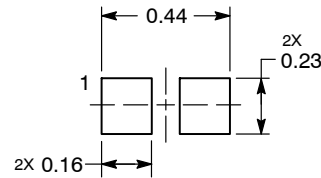

DIMENSIONS: MILLIMETERS

\*For additional information on our Pb-Free strategy and soldering details, please download the ON Semiconductor Soldering and Mounting Techniques Reference Manual, SOLDERRM/D.

<b>DOCUMENT NUMBER:</b>	<b>98AON82198E</b>	Electronic versions are uncontrolled except when accessed directly from the Document Repository. Printed versions are uncontrolled except when stamped "CONTROLLED COPY" in red.
<b>DESCRIPTION:</b>	<b>DSN2, 0.435X0.23, 0.27P (01005)</b>	<b>PAGE 1 OF 1</b>

ON Semiconductor and are trademarks of Semiconductor Components Industries, LLC dba ON Semiconductor or its subsidiaries in the United States and/or other countries. ON Semiconductor reserves the right to make changes without further notice to any products herein. ON Semiconductor makes no warranty, representation or guarantee regarding the suitability of its products for any particular purpose, nor does ON Semiconductor assume any liability arising out of the application or use of any product or circuit, and specifically disclaims any and all liability, including without limitation special, consequential or incidental damages. ON Semiconductor does not convey any license under its patent rights nor the rights of others.

# MECHANICAL CASE OUTLINE

## PACKAGE DIMENSIONS

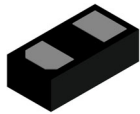

**X4DFN2, 0.60x0.30x0.19, 0.36P**  
**CASE 152AX**  
**ISSUE H**

DATE 01 AUG 2023

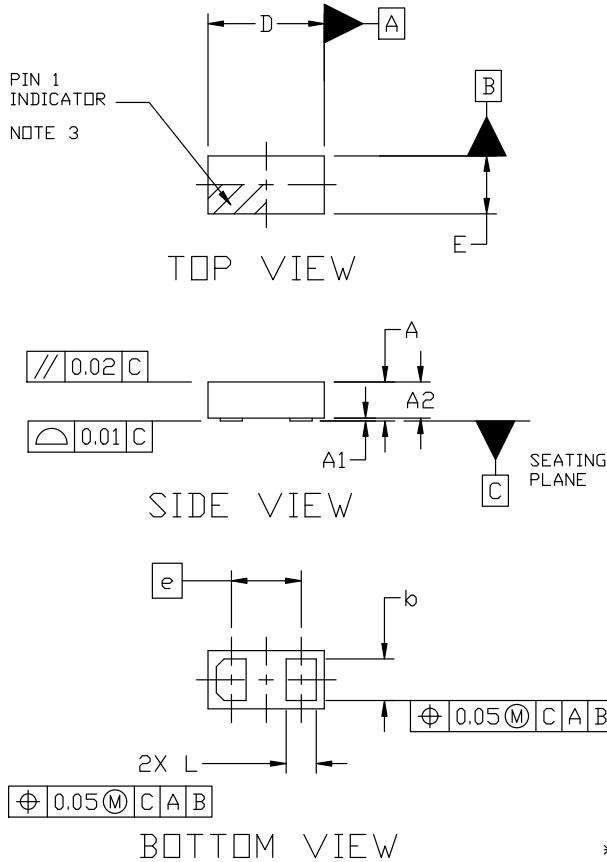

**NOTES:**

1. DIMENSIONING AND TOLERANCING PER ASME Y14.5M, 1994.
2. CONTROLLING DIMENSION: MILLIMETERS

DIM	MILLIMETERS		
	MIN.	NOM.	MAX.
A	0.175	0.200	0.225
A1	0.018 REF		
A2	0.180	0.190	0.200
b	0.205	0.215	0.225
D	0.575	0.600	0.625
E	0.275	0.300	0.325
e	0.36 BSC		
L	0.145	0.155	0.165

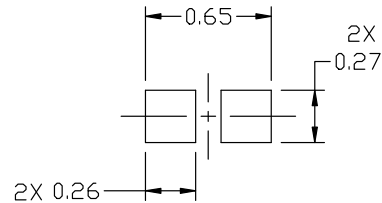

**RECOMMENDED MOUNTING FOOTPRINT**

\* For additional information on our Pb-Free strategy and soldering details, please download the ON Semiconductor Soldering and Mounting Techniques Reference Manual, SOLDERRM/D.

**GENERIC MARKING DIAGRAM\***

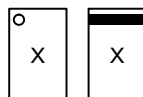

X = Specific Device Code

\*This information is generic. Please refer to device data sheet for actual part marking. Pb-Free indicator, "G", may or not be present. Some products may not follow the Generic Marking.

<b>DOCUMENT NUMBER:</b>	<b>98AON06808G</b>	Electronic versions are uncontrolled except when accessed directly from the Document Repository. Printed versions are uncontrolled except when stamped "CONTROLLED COPY" in red.
<b>DESCRIPTION:</b>	<b>X4DFN2, 0.60x0.30x0.19, 0.36P</b>	<b>PAGE 1 OF 1</b>

onsemi and ONSEMI are trademarks of Semiconductor Components Industries, LLC dba onsemi or its subsidiaries in the United States and/or other countries. onsemi reserves the right to make changes without further notice to any products herein. onsemi makes no warranty, representation or guarantee regarding the suitability of its products for any particular purpose, nor does onsemi assume any liability arising out of the application or use of any product or circuit, and specifically disclaims any and all liability, including without limitation special, consequential or incidental damages. onsemi does not convey any license under its patent rights nor the rights of others.



SCALE 12:1

**WLCSP2, 0.6x0.3**  
**CASE 567AV**  
**ISSUE C**

DATE 22 SEP 2017

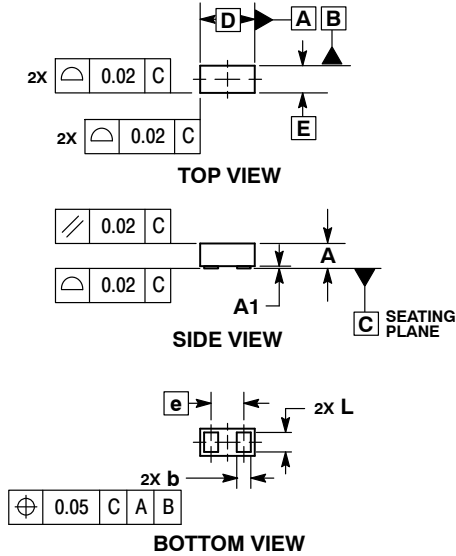

- NOTES:
1. DIMENSIONING AND TOLERANCING PER ASME Y14.5M, 1994.
  2. CONTROLLING DIMENSION: MILLIMETERS.

MILLIMETERS			
DIM	MIN	NOM	MAX
A	0.250	0.275	0.300
A1	0.000	0.025	0.050
b	0.140	0.155	0.170
D	0.570	0.600	0.630
E	0.270	0.300	0.330
e	0.36 BSC		
L	0.190	0.215	0.240

**GENERIC MARKING DIAGRAM\***



X = Specific Device Code

\*This information is generic. Please refer to device data sheet for actual part marking. Pb-Free indicator, "G" or microdot "▪", may or may not be present. Some products may not follow the Generic Marking.

**RECOMMENDED SOLDER FOOTPRINT\***

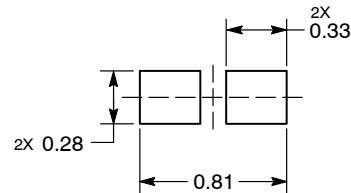

DIMENSIONS: MILLIMETERS

\*For additional information on our Pb-Free strategy and soldering details, please download the ON Semiconductor Soldering and Mounting Techniques Reference Manual, SOLDERRM/D.

<b>DOCUMENT NUMBER:</b>	<b>98AON49805E</b>	Electronic versions are uncontrolled except when accessed directly from the Document Repository. Printed versions are uncontrolled except when stamped "CONTROLLED COPY" in red.
<b>DESCRIPTION:</b>	<b>WLCSP2, 0.6X0.3</b>	<b>PAGE 1 OF 1</b>

ON Semiconductor and are trademarks of Semiconductor Components Industries, LLC dba ON Semiconductor or its subsidiaries in the United States and/or other countries. ON Semiconductor reserves the right to make changes without further notice to any products herein. ON Semiconductor makes no warranty, representation or guarantee regarding the suitability of its products for any particular purpose, nor does ON Semiconductor assume any liability arising out of the application or use of any product or circuit, and specifically disclaims any and all liability, including without limitation special, consequential or incidental damages. ON Semiconductor does not convey any license under its patent rights nor the rights of others.

**onsemi**, **Onsemi**, and other names, marks, and brands are registered and/or common law trademarks of Semiconductor Components Industries, LLC dba "**onsemi**" or its affiliates and/or subsidiaries in the United States and/or other countries. **onsemi** owns the rights to a number of patents, trademarks, copyrights, trade secrets, and other intellectual property. A listing of **onsemi**'s product/patent coverage may be accessed at [www.onsemi.com/site/pdf/Patent-Marking.pdf](http://www.onsemi.com/site/pdf/Patent-Marking.pdf). **onsemi** reserves the right to make changes at any time to any products or information herein, without notice. The information herein is provided "as-is" and **onsemi** makes no warranty, representation or guarantee regarding the accuracy of the information, product features, availability, functionality, or suitability of its products for any particular purpose, nor does **onsemi** assume any liability arising out of the application or use of any product or circuit, and specifically disclaims any and all liability, including without limitation special, consequential or incidental damages. Buyer is responsible for its products and applications using **onsemi** products, including compliance with all laws, regulations and safety requirements or standards, regardless of any support or applications information provided by **onsemi**. "Typical" parameters which may be provided in **onsemi** data sheets and/or specifications can and do vary in different applications and actual performance may vary over time. All operating parameters, including "Typicals" must be validated for each customer application by customer's technical experts. **onsemi** does not convey any license under any of its intellectual property rights nor the rights of others. **onsemi** products are not designed, intended, or authorized for use as a critical component in life support systems or any FDA Class 3 medical devices or medical devices with a same or similar classification in a foreign jurisdiction or any devices intended for implantation in the human body. Should Buyer purchase or use **onsemi** products for any such unintended or unauthorized application, Buyer shall indemnify and hold **onsemi** and its officers, employees, subsidiaries, affiliates, and distributors harmless against all claims, costs, damages, and expenses, and reasonable attorney fees arising out of, directly or indirectly, any claim of personal injury or death associated with such unintended or unauthorized use, even if such claim alleges that **onsemi** was negligent regarding the design or manufacture of the part. **onsemi** is an Equal Opportunity/Affirmative Action Employer. This literature is subject to all applicable copyright laws and is not for resale in any manner.

## ADDITIONAL INFORMATION

### TECHNICAL PUBLICATIONS:

Technical Library: [www.onsemi.com/design/resources/technical-documentation](http://www.onsemi.com/design/resources/technical-documentation)  
onsemi Website: [www.onsemi.com](http://www.onsemi.com)

### ONLINE SUPPORT: [www.onsemi.com/support](http://www.onsemi.com/support)

For additional information, please contact your local Sales Representative at [www.onsemi.com/support/sales](http://www.onsemi.com/support/sales)

## Looking for pricing, stock, or lifecycle information?

Click below to explore more details on WIN SOURCE:

 [View ESD5111FCT5G on WIN SOURCE](#)

 [ON Semiconductor](#) Information

## Optimize Your Supply Chain with WIN SOURCE Solutions

-  Global Sourcing Solution
-  Obsolete Management
-  Cost Control Management
-  Shortage Management
-  Alternative Solution
-  Excess Inventory Management