



**THE DATASHEET OF  
BBY5802WE6127XT**



**Silicon Tuning Diodes**

- Excellent linearity
- High Q hyperabrupt tuning diode
- Low series resistance
- Designed for low tuning voltage operation for VCO's in mobile communications equipment
- For low frequency control elements such as TCXOs and VCXOs
- Very low capacitance spread
- Pb-free (RoHS compliant) package<sup>1)</sup>
- Qualified according AEC Q101

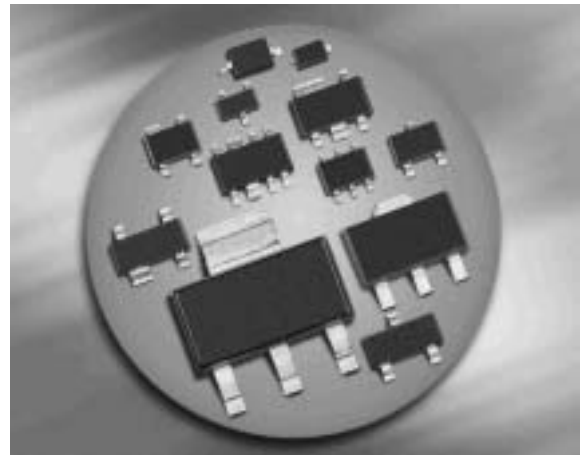

**BBY58-02L/V**  
**BBY58-02W**  
**BBY58-03W**

**BBY58-05W**

**BBY58-06W**

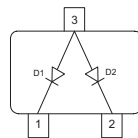
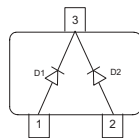
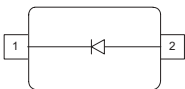

Type	Package	Configuration	$L_S$ (nH)	Marking
BBY58-02L	TSLP-2-1	single, leadless	0.4	88
BBY58-02V	SC79	single	0.6	8
BBY58-02W	SCD80	single	0.6	88
BBY58-03W	SOD323	single	0.6	8 yel.
BBY58-05W	SOT323	common cathode	1.4	B5s
BBY58-06W	SOT323	common anode	1.4	B6s

**Maximum Ratings** at  $T_A = 25^\circ\text{C}$ , unless otherwise specified

Parameter	Symbol	Value	Unit
Diode reverse voltage	$V_R$	10	V
Forward current	$I_F$	20	mA
Operating temperature range	$T_{OP}$	-55 ... 150	°C
Storage temperature	$T_{stg}$	-55 ... 150	

<sup>1</sup>Pb-containing package may be available upon special request

**Electrical Characteristics at  $T_A = 25^\circ\text{C}$ , unless otherwise specified**

Parameter	Symbol	Values			Unit
		min.	typ.	max.	
<b>DC Characteristics</b>					
Reverse current	$I_R$				nA
$V_R = 8\text{ V}$		-	-	10	
$V_R = 8\text{ V}, T_A = 85^\circ\text{C}$		-	-	100	
<b>AC Characteristics</b>					
Diode capacitance	$C_T$				pF
$V_R = 1\text{ V}, f = 1\text{ MHz}$		17.5	18.3	19.3	
$V_R = 2\text{ V}, f = 1\text{ MHz}$		11.4	12.35	13.3	
$V_R = 3\text{ V}, f = 1\text{ MHz}$		7.8	8.6	9.3	
$V_R = 4\text{ V}, f = 1\text{ MHz}$		5.5	6	6.6	
$V_R = 6\text{ V}, f = 1\text{ MHz}$		3.8	4.7	5.5	
Capacitance ratio	$C_{T1}/C_{T3}$	1.9	2.15	2.4	-
$V_R = 1\text{ V}, V_R = 3\text{ V}, f = 1\text{ MHz}$					
Capacitance ratio	$C_{T1}/C_{T4}$	2.7	3.05	3.5	
$V_R = 1\text{ V}, V_R = 4\text{ V}, f = 1\text{ MHz}$					
Capacitance ratio	$C_{T4}/C_{T6}$	1.15	1.3	1.45	
$V_R = 4\text{ V}, V_R = 6\text{ V}, f = 1\text{ MHz}$					
Series resistance	$r_S$				$\Omega$
$V_R = 1\text{ V}, f = 470\text{ MHz}, \text{BBY58-02L}, -07\text{L4}$		-	0.3	-	
$V_R = 1\text{ V}, f = 470\text{ MHz}, \text{all other}$		-	0.25	-	

**Diode capacitance  $C_T = f(V_R)$**

$f = 1\text{MHz}$

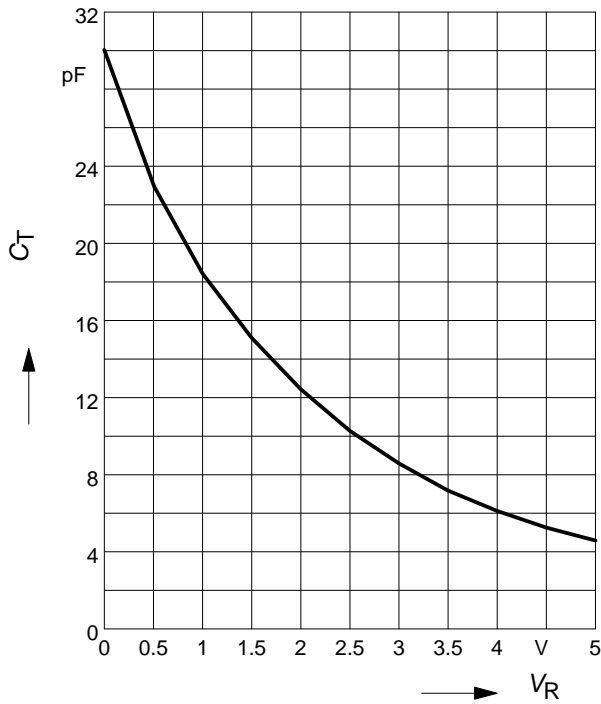

**Normalized diode capacitance**

$C_{(T_A)}/C_{(25^\circ\text{C})} = f(T_A)$

$f = 1\text{MHz}, V_R = \text{Parameter}$

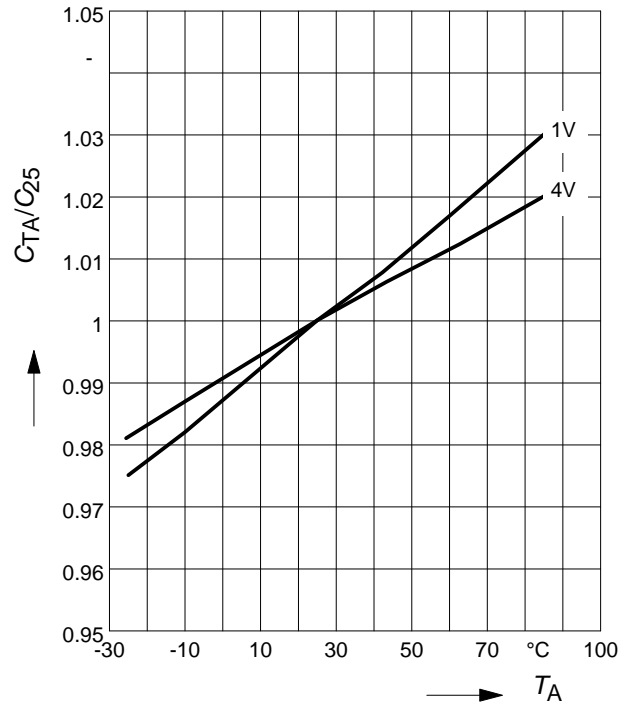

**Temperature coefficient of the diode capacitance  $T_{CC} = f(V_R)$**

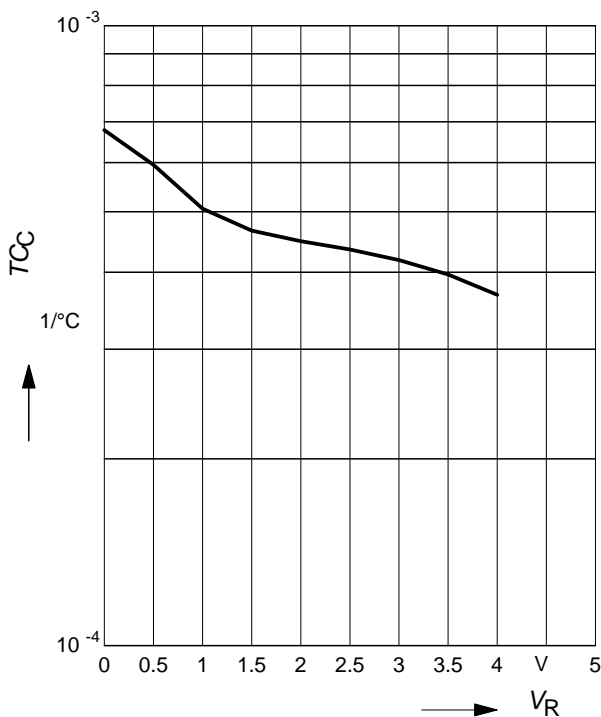

Package Outline

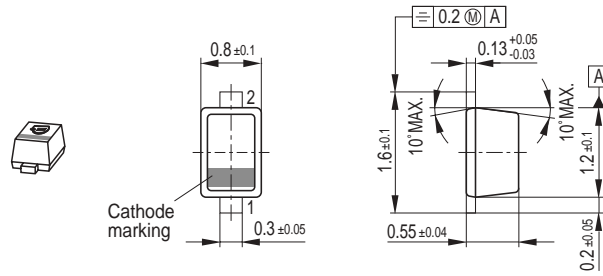

Foot Print

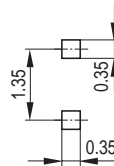

Marking Layout (Example)

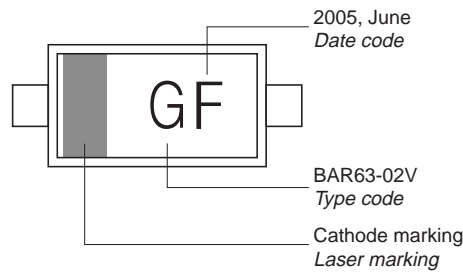

Standard Packing

Reel ø180 mm = 3.000 Pieces/Reel  
 Reel ø180 mm = 8.000 Pieces/Reel (2 mm Pitch)  
 Reel ø330 mm = 10.000 Pieces/Reel

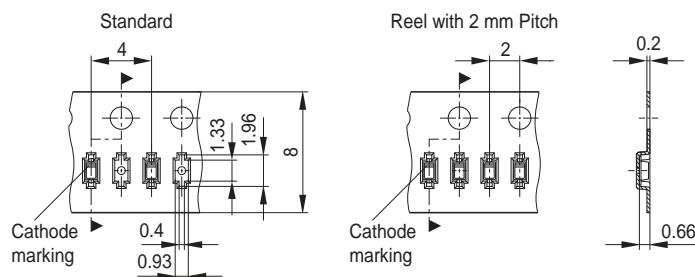

Package Outline

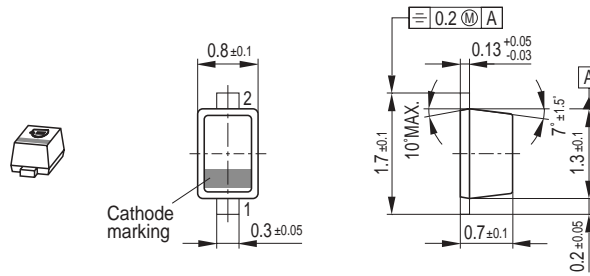

Foot Print

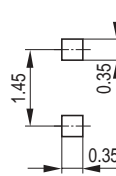

Marking Layout (Example)

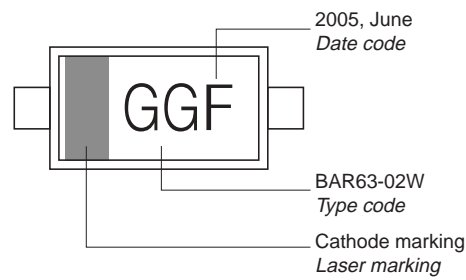

Standard Packing

Reel  $\varnothing$ 180 mm = 3.000 Pieces/Reel  
 Reel  $\varnothing$ 180 mm = 8.000 Pieces/Reel (2 mm Pitch)  
 Reel  $\varnothing$ 330 mm = 10.000 Pieces/Reel

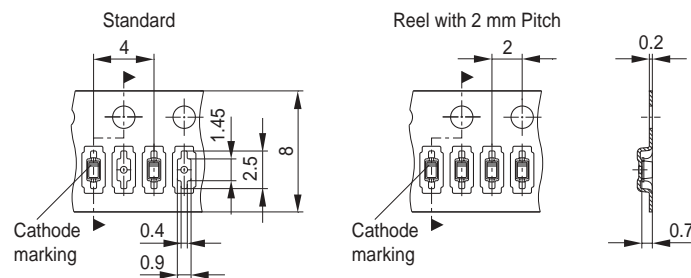

Date Code marking for discrete packages with one digit (SCD80, SC79, SC75<sup>1)</sup>) CES-Code

Month	2003	2004	2005	2006	2007	2008	2009	2010	2011	2012	2013	2014
01	a	p	A	P	a	p	A	P	a	p	A	P
02	b	q	B	Q	b	q	B	Q	b	q	B	Q
03	c	r	C	R	c	r	C	R	c	r	C	R
04	d	s	D	S	d	s	D	S	d	s	D	S
05	e	t	E	T	e	t	E	T	e	t	E	T
06	f	u	F	U	f	u	F	U	f	u	F	U
07	g	v	G	V	g	v	G	V	g	v	G	V
08	h	x	H	X	h	x	H	X	h	x	H	X
09	j	y	J	Y	j	y	J	Y	j	y	J	Y
10	k	z	K	Z	k	z	K	Z	k	z	K	Z
11	l	2	L	4	l	2	L	4	l	2	L	4
12	n	3	N	5	n	3	N	5	n	3	N	5

1) New Marking Layout for SC75, implemented at October 2005.

Package Outline

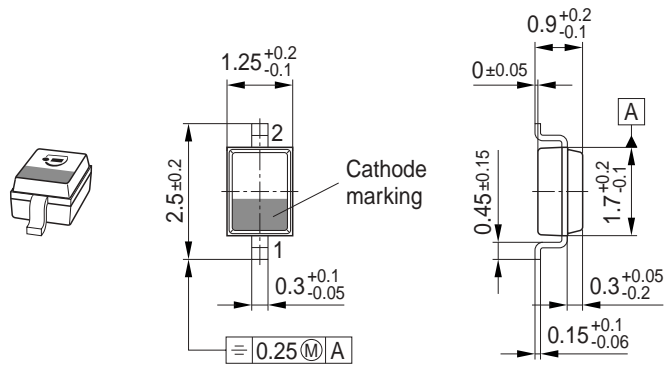

Foot Print

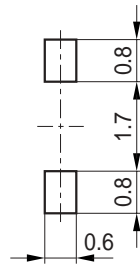

Marking Layout (Example)

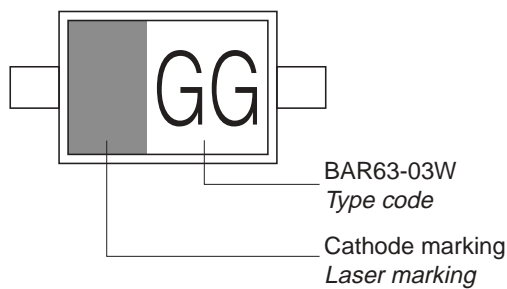

Standard Packing

Reel  $\varnothing$ 180 mm = 3.000 Pieces/Reel  
 Reel  $\varnothing$ 330 mm = 10.000 Pieces/Reel

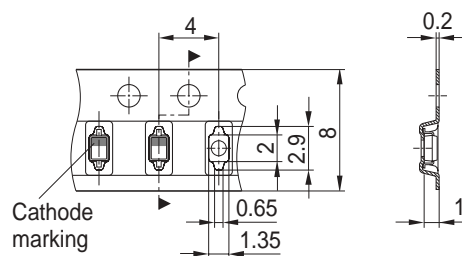

Package Outline

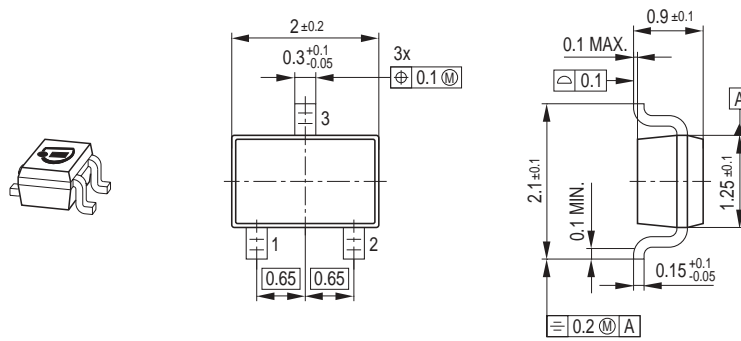

Foot Print

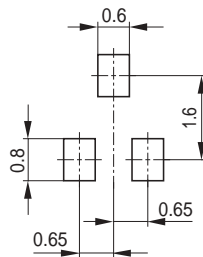

Marking Layout (Example)

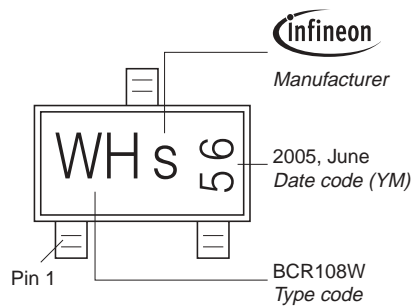

Standard Packing

Reel  $\varnothing$ 180 mm = 3.000 Pieces/Reel  
 Reel  $\varnothing$ 330 mm = 10.000 Pieces/Reel

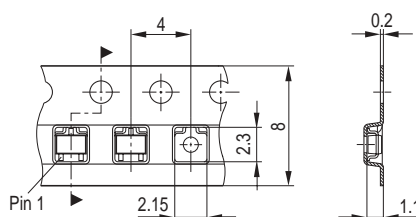

### Package Outline

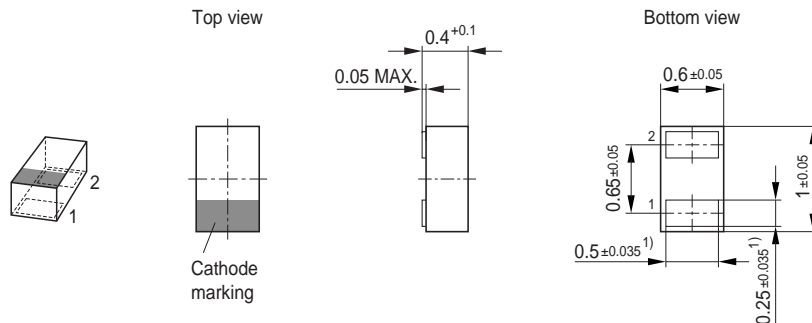

1) Dimension applies to plated terminal

### Foot Print

For board assembly information please refer to Infineon website "Packages"

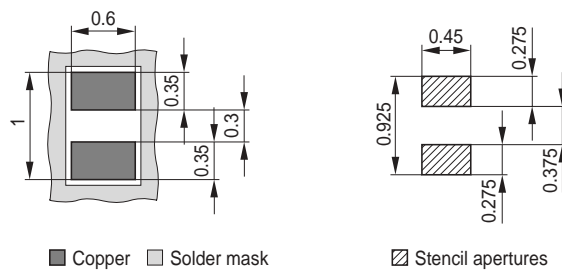

■ Copper □ Solder mask

▨ Stencil apertures

### Marking Layout (Example)

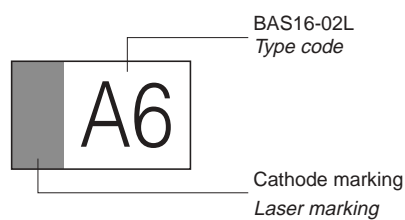

BAS16-02L  
Type code

Cathode marking  
Laser marking

### Standard Packing

Reel  $\varnothing$ 180 mm = 15.000 Pieces/Reel  
Reel  $\varnothing$ 330 mm = 50.000 Pieces/Reel (optional)

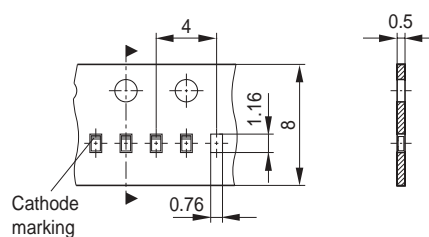

Edition 2006-02-01  
Published by  
Infineon Technologies AG  
81726 München, Germany  
© Infineon Technologies AG 2007.  
All Rights Reserved.

### **Attention please!**

The information given in this dokument shall in no event be regarded as a guarantee of conditions or characteristics ("Beschaffenheitsgarantie"). With respect to any examples or hints given herein, any typical values stated herein and/or any information regarding the application of the device, Infineon Technologies hereby disclaims any and all warranties and liabilities of any kind, including without limitation warranties of non-infringement of intellectual property rights of any third party.

### **Information**

For further information on technology, delivery terms and conditions and prices please contact your nearest Infineon Technologies Office ([www.infineon.com](http://www.infineon.com)).

### **Warnings**

Due to technical requirements components may contain dangerous substances. For information on the types in question please contact your nearest Infineon Technologies Office.

Infineon Technologies Components may only be used in life-support devices or systems with the express written approval of Infineon Technologies, if a failure of such components can reasonably be expected to cause the failure of that life-support device or system, or to affect the safety or effectiveness of that device or system.

Life support devices or systems are intended to be implanted in the human body, or to support and/or maintain and sustain and/or protect human life. If they fail, it is reasonable to assume that the health of the user or other persons may be endangered.

## Looking for pricing, stock, or lifecycle information?

Click below to explore more details on WIN SOURCE:

- ⊖ [View BBY5802WE6127XT on WIN SOURCE](#)
- ⊖ [Infineon Technologies Information](#)

## Optimize Your Supply Chain with WIN SOURCE Solutions

- ✓ Global Sourcing Solution
- ✓ Obsolete Management
- ✓ Cost Control Management
- ✓ Shortage Management
- ✓ Alternative Solution
- ✓ Excess Inventory Management