



# THE DATASHEET OF ELQ3H7(TA)



### 8PIN 16 PIN ULTRA SMALL SSOP PHOTOTRANSISTOR PHOTOCOUPLER

#### Features:

- Halogens free
- Current transfer ratio  
(CTR: 50~600% at  $I_F = 5\text{mA}$ ,  $V_{CE} = 5\text{V}$ )
- High isolation voltage between input and output ( $V_{iso} = 3750\text{ V rms}$ )
- Compact 8 Pin SSOP with a 2.0 mm profile
- Pb free and RoHS compliant.
- UL approved (E214129)
- VDE approved (40028116)
- SEMKO approved
- NEMKO approved
- DEMKO approved
- FIMKO approved
- CQC approved

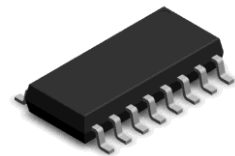
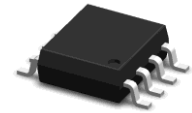

#### Description

The ELD3H7 and ELQ3H7 contains of an infrared emitting diode optically coupled to a phototransistor detector encapsulated with green compound.

ELD3H7 offers 2 channels in a 8-pin small outline SMD package, while ELQ3H7 offers 4 channels in a 16-pin small outline SMD package.

#### Applications

- DC-DC Converters
- Programmable controllers
- Telecommunication equipments
- Signal transmission between circuits of different potentials and impedances

#### Schematic

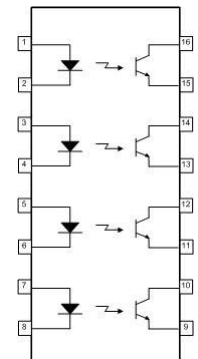
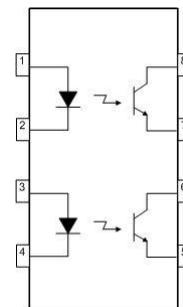

1, 3 Anode  
2, 4 Cathode  
5, 7 Emitter  
6, 8 Collector

1, 3, 5, 7 Anode  
2, 4, 6, 8 Cathode  
9, 11, 13, 15 Emitter  
10, 12, 14, 16 Collector

## 8PIN 16 PIN ULTRA SMALL SSOP PHOTOTRANSISTOR PHOTOCOUPLER

## ELD3H7 ELQ3H7 Series

### Absolute Maximum Ratings (T<sub>a</sub>=25°C)

Parameter		Symbol	Rating	Unit
Input	Forward current	I <sub>F</sub>	60	mA
	Peak forward current (1us, pulse)	I <sub>FP</sub>	1	A
	Reverse voltage	V <sub>R</sub>	6	V
	Power dissipation	P <sub>D</sub>	70	mW
Output	Power dissipation	P <sub>C</sub>	150	mW
	Collector current	I <sub>C</sub>	50	mA
	Collector-Emitter voltage	V <sub>CEO</sub>	80	V
	Emitter-Collector voltage	V <sub>ECO</sub>	7	V
Total power dissipation		P <sub>TOT</sub>	200	mW
Isolation voltage <sup>*1</sup>		V <sub>ISO</sub>	3750	V rms
Operating temperature		T <sub>OPR</sub>	-55 ~ +110	°C
Storage temperature		T <sub>STG</sub>	-55 ~ +125	°C
Soldering temperature <sup>*2</sup>		T <sub>SOL</sub>	260	°C

#### Notes

\*1 AC for 1 minute, R.H.= 40 ~ 60% R.H. In this test, LED side pins shorted together, and detector side pins shorted together.

\*2 For 10 seconds.

## 8PIN 16 PIN ULTRA SMALL SSOP PHOTOTRANSISTOR PHOTOCOUPLER

## ELD3H7 ELQ3H7 Series

### Electrical Characteristics (T<sub>a</sub>=25°C unless specified otherwise)

#### Input

Parameter	Symbol	Min.	Typ.*	Max.	Unit	Condition
Forward voltage	V <sub>F</sub>	-	1.2	1.4	V	I <sub>F</sub> = 20mA
Reverse current	I <sub>R</sub>	-	-	10	μA	V <sub>R</sub> = 4V
Input capacitance	C <sub>in</sub>	-	30	250	pF	V = 0, f = 1kHz

#### Output

Parameter	Symbol	Min.	Typ.*	Max.	Unit	Condition
Collector-Emitter dark current	I <sub>CEO</sub>	-	-	100	nA	V <sub>CE</sub> = 20V, I <sub>F</sub> = 0mA
Collector-Emitter breakdown voltage	BV <sub>CEO</sub>	80	-	-	V	I <sub>C</sub> = 0.1mA
Emitter-Collector breakdown voltage	BV <sub>ECO</sub>	7	-	-	V	I <sub>E</sub> = 0.1mA

### Transfer Characteristics (T<sub>a</sub>=25°C unless specified otherwise)

Parameter	Symbol	Min.	Typ.*	Max.	Unit	Condition
Current Transfer ratio	CTR	50	-	600	%	I <sub>F</sub> = 5mA, V <sub>CE</sub> = 5V

### Transfer Characteristics (T<sub>a</sub>=25°C unless specified otherwise)

Parameter	Symbol	Min.	Typ.*	Max.	Unit	Condition
Collector-Emitter saturation voltage	V <sub>CE(sat)</sub>	-	0.1	0.2	V	I <sub>F</sub> = 10mA, I <sub>C</sub> = 1mA
Isolation resistance	R <sub>IO</sub>	5×10 <sup>10</sup>	-	-	Ω	V <sub>IO</sub> = 500Vdc, 40~60% R.H.
Floating capacitance	C <sub>IO</sub>	-	0.3	1.0	pF	V <sub>IO</sub> = 0, f = 1MHz
Rise time	t <sub>r</sub>	-	5	18	μs	V <sub>CE</sub> = 2V, I <sub>C</sub> = 2mA, R <sub>L</sub> = 100Ω
Fall time	t <sub>f</sub>	-	3	18	μs	

\* Typical values at T<sub>a</sub> = 25°C

## 8PIN 16 PIN ULTRA SMALL SSOP PHOTOTRANSISTOR PHOTOCOUPLER

## ELD3H7 ELQ3H7 Series

### Typical Performance Curves

Figure 1. Forward Current vs Forward Voltage

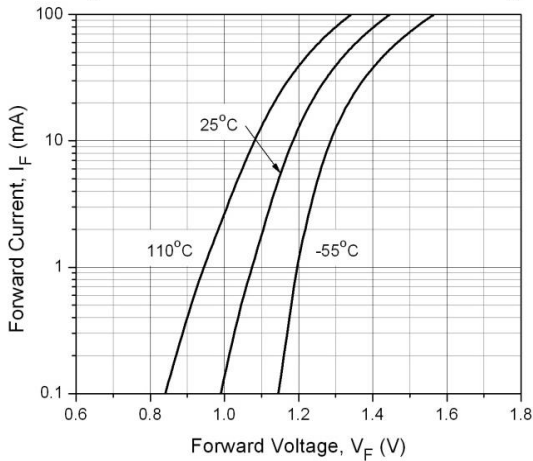

Figure 2. Normalized Collector Current vs Forward Current

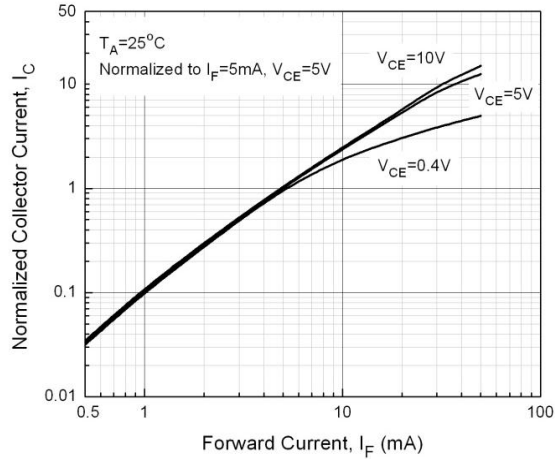

Figure 3. Normalized Current Transfer Ratio vs Forward Current

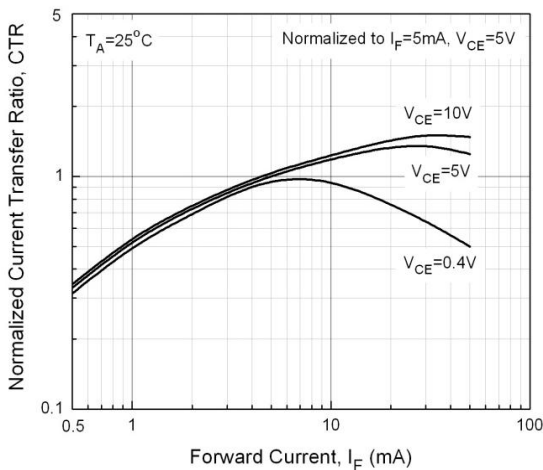

Figure 4. Normalized Collector Current vs Ambient Temperature

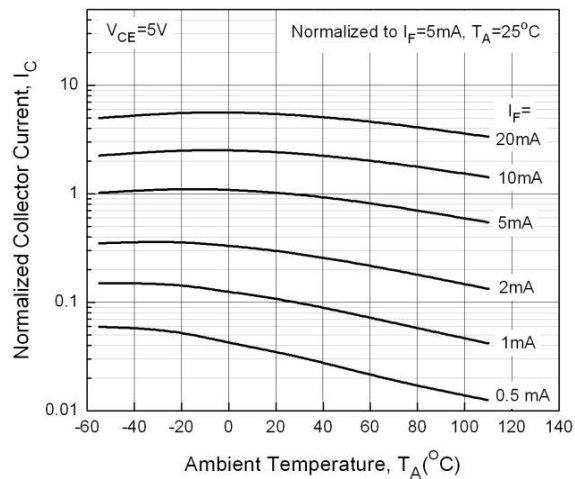

Figure 5. Normalized Current Transfer Ratio vs Ambient Temperature

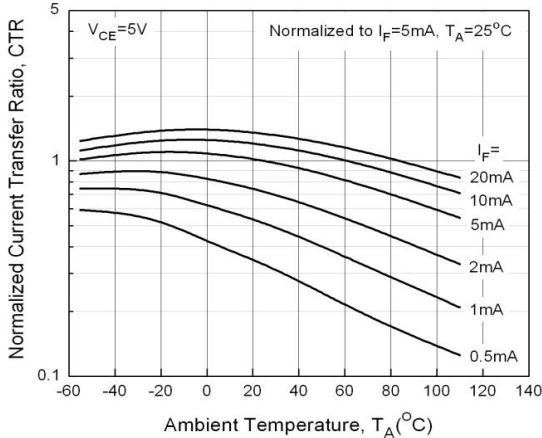
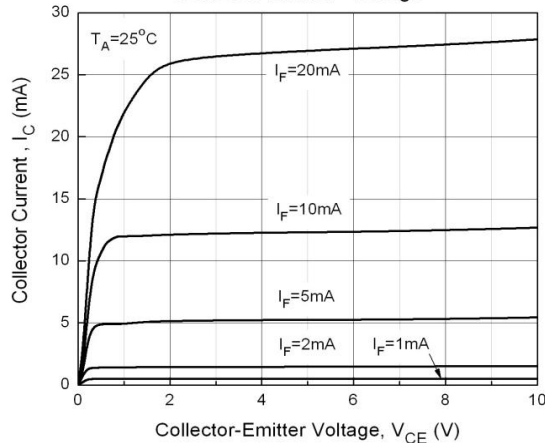

Figure 6. Collector Current vs Collector-Emitter Voltage



## 8PIN 16 PIN ULTRA SMALL SSOP PHOTOTRANSISTOR PHOTOCOUPLER

## ELD3H7 ELQ3H7 Series

Figure 7. Collector Current vs Collector-Emitter Voltage

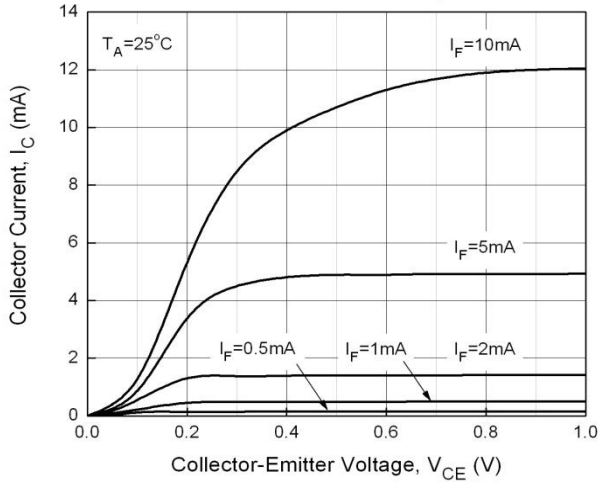

Figure 8. Collector Dark Current vs Ambient Temperature

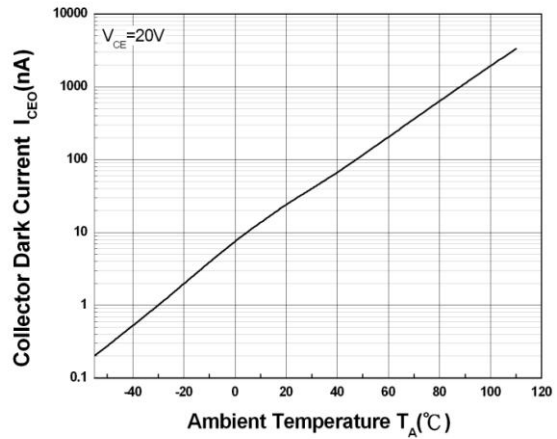

Figure 9. Collector-Emitter Saturation Voltage vs Ambient Temperature

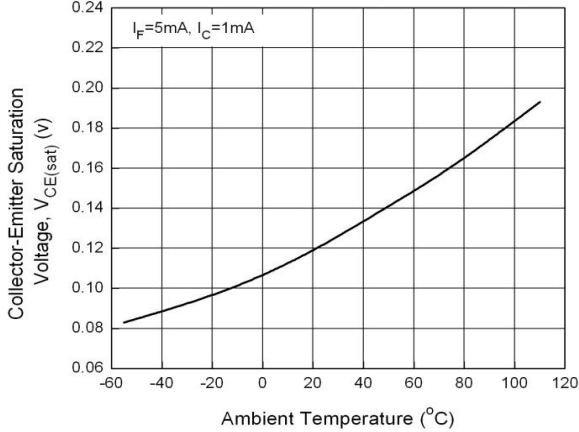

Figure 10. Switching Time vs Load Resistance

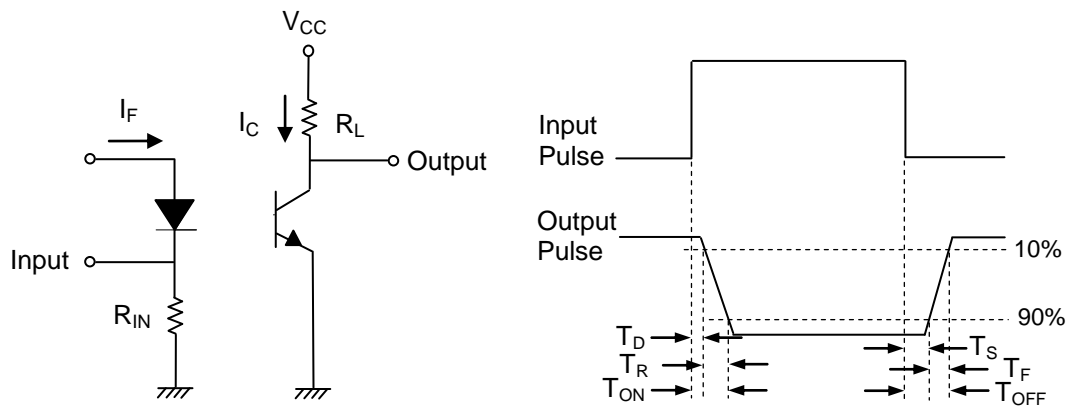
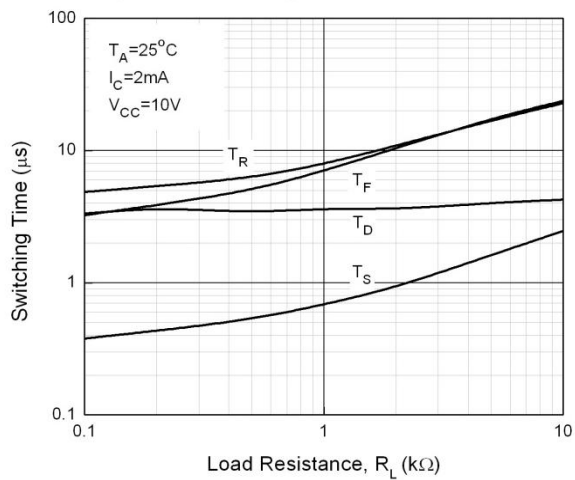

Figure 11. Switching Time Test Circuit & Waveforms

### 8PIN 16 PIN ULTRA SMALL SSOP PHOTOTRANSISTOR PHOTOCOUPLER

---

#### Order Information

#### Part Number

## ELD3H7(Z)-V, ELQ3H7(Z)-V

#### Note

D3H7, Q3H7 = Part No.

Z = Tape and reel option (TA or none).

V = VDE (optional)

Option	Description	Packing quantity
None	Tube option of ELD3H7	80 units per tube
(TA)	Tape & reel option of ELD3H7	1000 units per reel
None	Tube option of ELQ3H7	40 units per tube
(TA)	Tape & reel option of ELQ3H7	1000 units per reel

## 8PIN 16 PIN ULTRA SMALL SSOP PHOTOTRANSISTOR PHOTOCOUPLER

## ELD3H7 ELQ3H7 Series

### Package Drawing

(Dimensions in mm)

#### ELD3H7

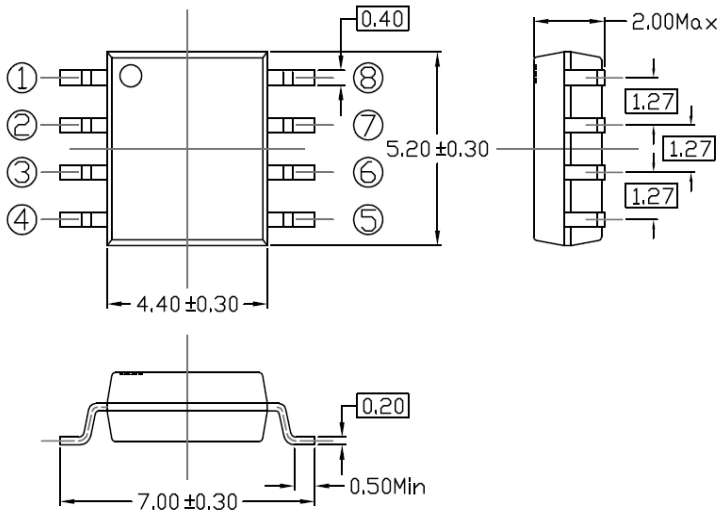

#### ELQ3H7

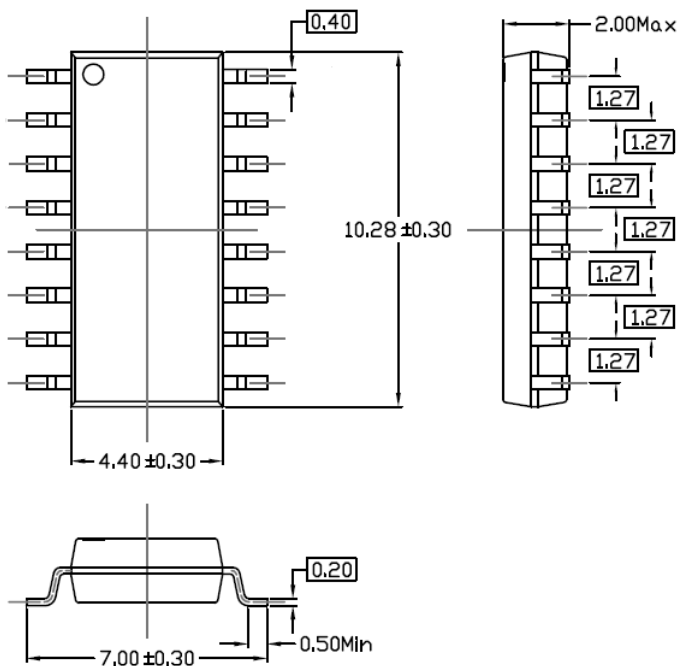

## 8PIN 16 PIN ULTRA SMALL SSOP PHOTOTRANSISTOR PHOTOCOUPLER

ELD3H7 ELQ3H7 Series

Recommended pad layout for surface mount leadform

ELD3H7

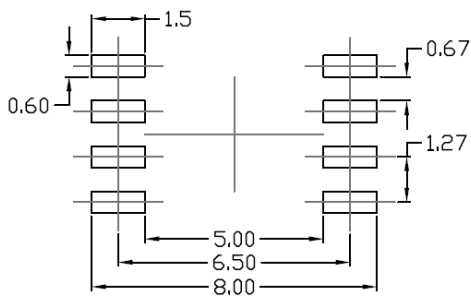

ELQ3H7

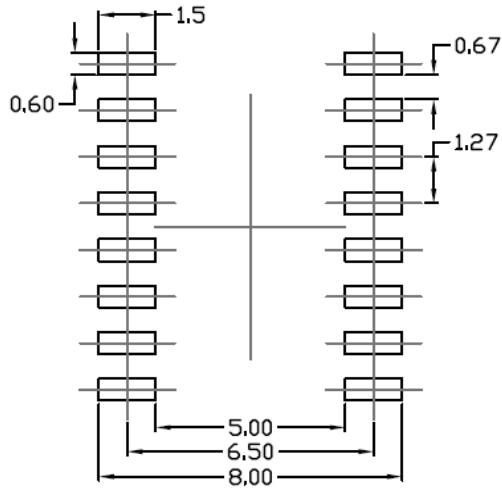

### Device Marking

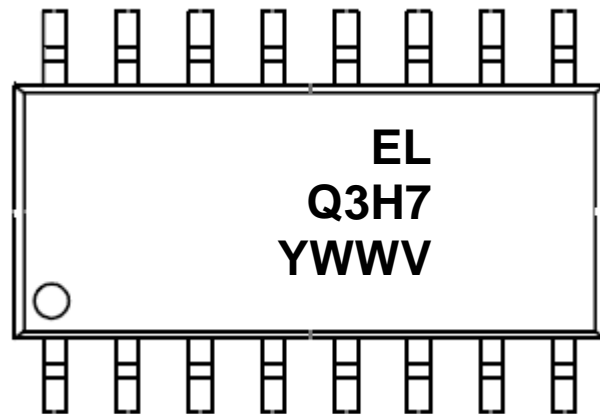
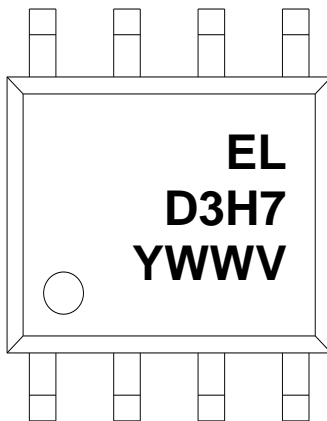

### Notes

EL denotes Everlight  
 Q3H7 D3H7 denotes Device Number  
 Y denotes 1 digit Year code  
 WW denotes 2 digit Week code  
 V denotes VDE (optional)

## 8PIN 16 PIN ULTRA SMALL SSOP PHOTOTRANSISTOR PHOTOCOUPLER

## ELD3H7 ELQ3H7 Series

### Tape & Reel Packing Specifications

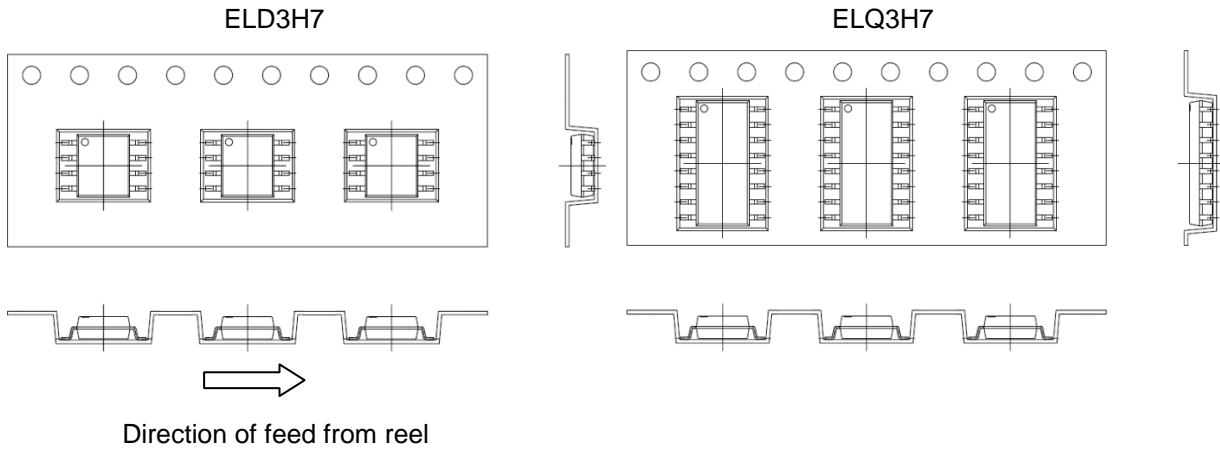

### Tape dimensions

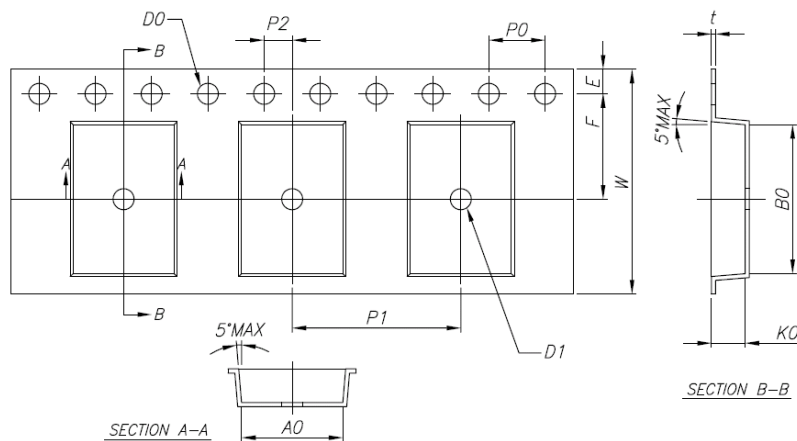

Dimension No.		<b>A0</b>	<b>B0</b>	<b>D0</b>	<b>D1</b>	<b>E</b>	<b>F</b>
Dimension (mm)	D3H7	7.4±0.1	5.6±0.1	1.5+0.1 -0	1.5+0.1 -0	1.75±0.1	7.5±0.1
	Q3H7	7.2±0.1	10.6±0.1	1.5+0.1 -0	1.5+0.1 -0	1.75±0.1	7.5±0.1
Dimension No.		<b>P0</b>	<b>P1</b>	<b>P2</b>	<b>t</b>	<b>W</b>	<b>K0</b>
Dimension (mm)	D3H7	4.0±0.1	12.0±0.1	2.0±0.1	0.3±0.05	16.0±0.3	2.4±0.1
	Q3H7	4.0±0.1	12.0±0.1	2.0±0.1	0.3±0.05	16.0±0.3	2.4±0.1

## 8PIN 16 PIN ULTRA SMALL SSOP PHOTOTRANSISTOR PHOTOCOUPLER

ELD3H7 ELQ3H7 Series

### Solder Reflow Temperature Profile

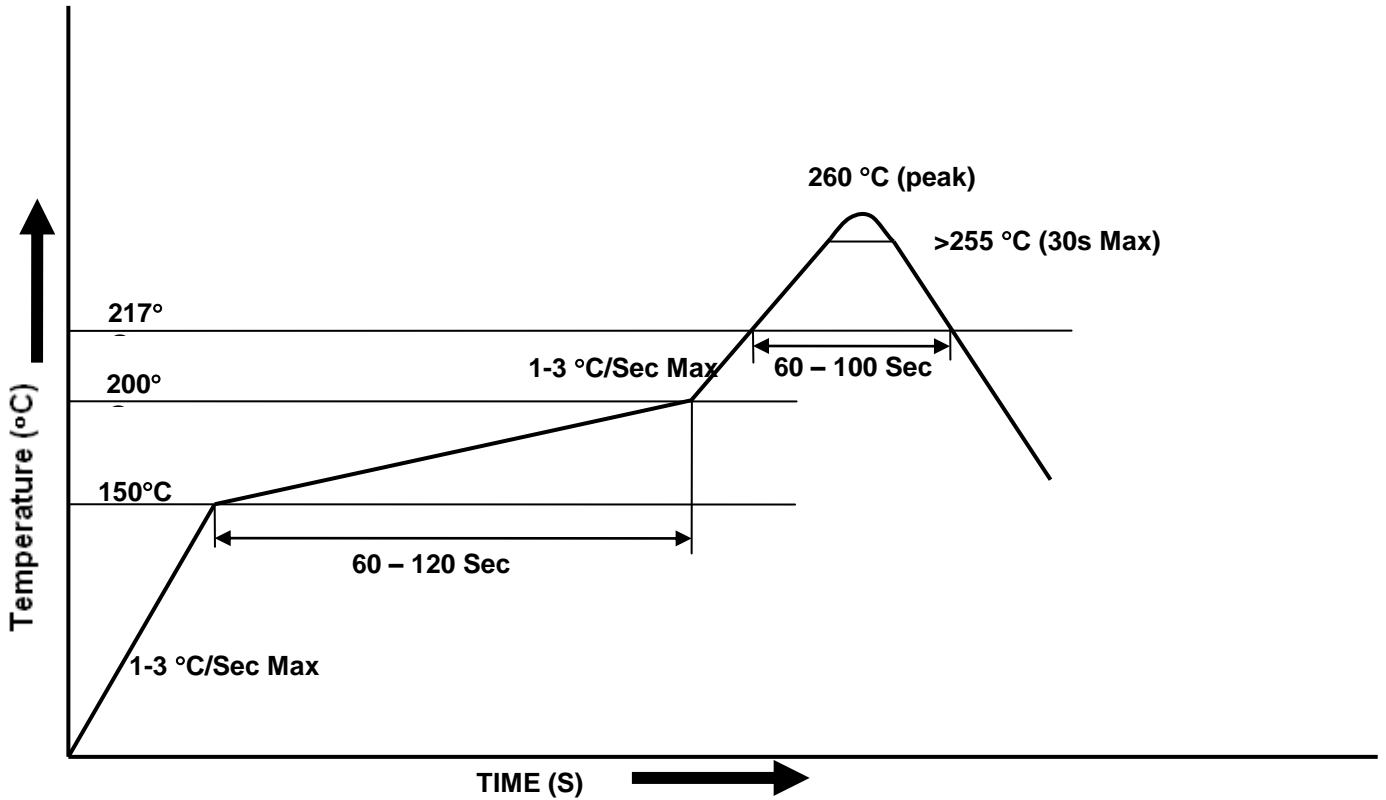

**8PIN 16 PIN ULTRA SMALL SSOP  
PHOTOTRANSISTOR PHOTOCOUPLER**

---

**DISCLAIMER**

1. The specifications in this datasheet may be changed without notice. EVERLIGHT reserves the authority on material change for above specification.
2. When using this product, please observe the absolute maximum ratings and the instructions for use as outlined in this datasheet. EVERLIGHT assumes no responsibility for any damage resulting from use of the product which does not comply with the absolute maximum ratings and the instructions included in this datasheet.
3. These specification sheets include materials protected under copyright of EVERLIGHT. Reproduction in any form is prohibited without the specific consent of EVERLIGHT.

## Looking for pricing, stock, or lifecycle information?

Click below to explore more details on WIN SOURCE:

- ⊖ [View ELQ3H7\(TA\) on WIN SOURCE](#)
- ⊖ [Everlight Electronics Co Ltd Information](#)

## Optimize Your Supply Chain with WIN SOURCE Solutions

- ✓ Global Sourcing Solution
- ✓ Obsolete Management
- ✓ Cost Control Management
- ✓ Shortage Management
- ✓ Alternative Solution
- ✓ Excess Inventory Management