



**THE DATASHEET OF  
BBY53E6327**



**Silicon Tuning Diode**

- High Q hyperabrupt tuning diode
- Designed for low tuning voltage operation for VCO's in mobile communications equipment
- High ratio at low reverse voltage
- Pb-free (RoHS compliant) package

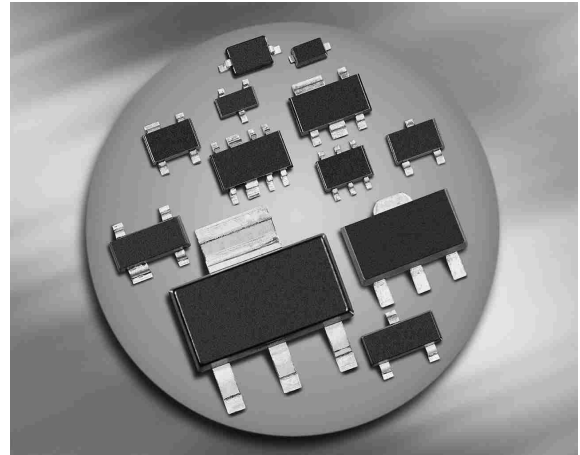

**BBY53-02L**  
**BBY53-02V**  
**BBY53-02W**  
**BBY53-03W**

**BBY53**  
**BBY53-05W**

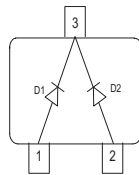
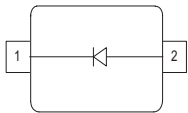

Type	Package	Configuration	$L_S$ (nH)	Marking
BBY53	SOT23	common cathode	2	S7s
BBY53-02L	TSLP-2-1	single, leadless	0.4	LL
BBY53-02V	SC79	single	0.6	L
BBY53-02W	SCD80	single	0.6	LL
BBY53-03W	SOD323	single	1.8	white 5
BBY53-05W	SOT323	common cathode	1.4	S7s

**Maximum Ratings at  $T_A = 25^\circ\text{C}$ , unless otherwise specified**

Parameter	Symbol	Value	Unit
Diode reverse voltage	$V_R$	6	V
Forward current	$I_F$	20	mA
Operating temperature range	$T_{op}$	-55 ... 125	°C
Storage temperature	$T_{stg}$	-55 ... 150	

**Electrical Characteristics at  $T_A = 25^\circ\text{C}$ , unless otherwise specified**

Parameter	Symbol	Values			Unit
		min.	typ.	max.	
<b>DC Characteristics</b>					
Reverse current	$I_R$				nA
$V_R = 4\text{ V}$		-	-	10	
$V_R = 4\text{ V}, T_A = 85^\circ\text{C}$		-	-	200	
<b>AC Characteristics</b>					
Diode capacitance	$C_T$				pF
$V_R = 1\text{ V}, f = 1\text{ MHz}$		4.8	5.3	5.8	
$V_R = 3\text{ V}, f = 1\text{ MHz}$		1.85	2.4	3.1	
Capacitance ratio	$C_{T1}/C_{T3}$	1.8	2.2	2.6	-
$V_R = 1\text{ V}, V_R = 3\text{ V}, f = 1\text{ MHz}$					
Series resistance	$r_S$	-	0.47	-	$\Omega$
$V_R = 1\text{ V}, f = 1\text{ GHz}$					

**Diode capacitance  $C_T = f(V_R)$**

$f = 1\text{ MHz}$

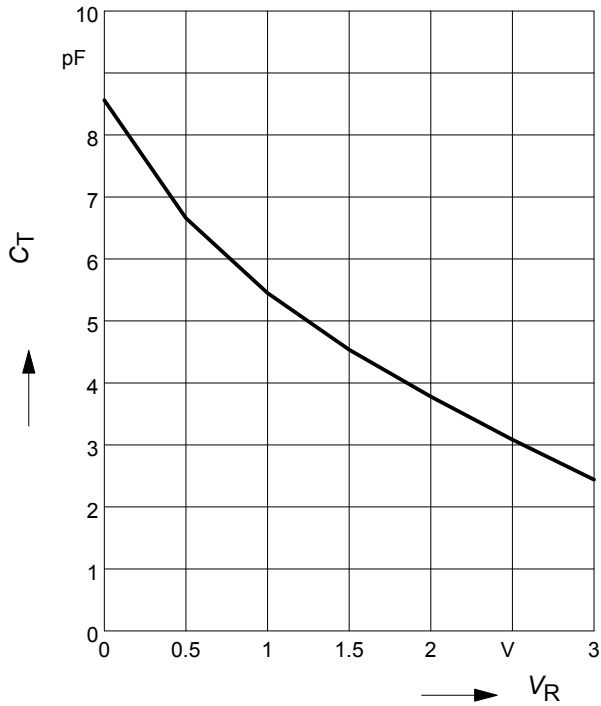

**Capacitance change  $\Delta C = f(T_A)$**

$f = 1\text{ MHz}$

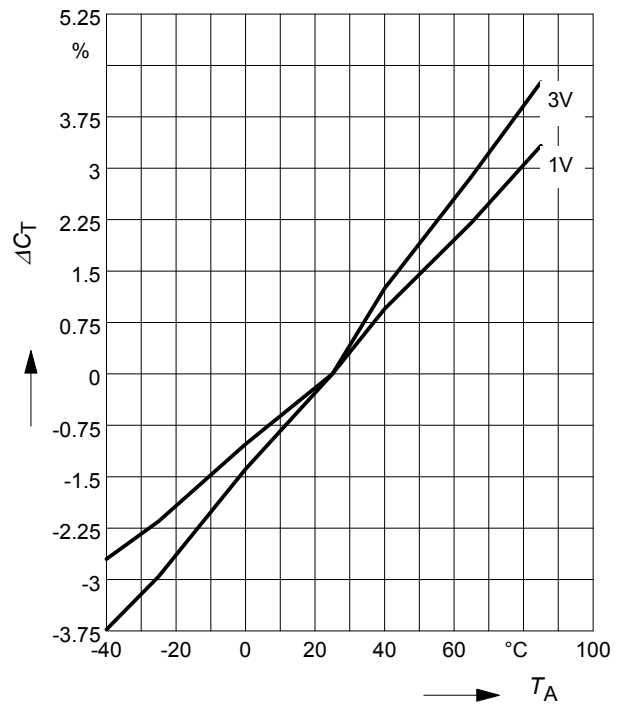

**Temperature coefficient of the diode capacitance  $TC_C = f(V_R)$**

$f = 1\text{ MHz}$

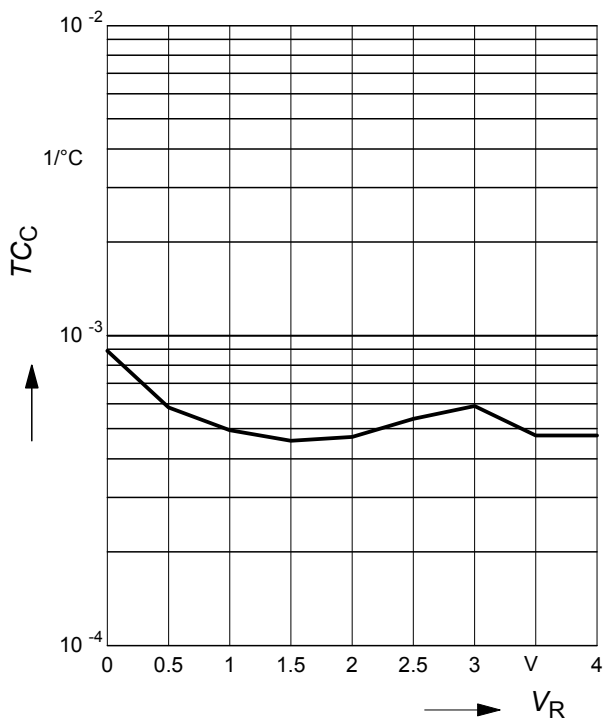

### Package Outline



### Foot Print

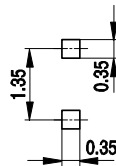

### Marking Layout (Example)

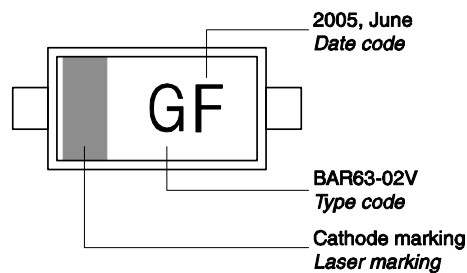

### Standard Packing

Reel  $\varnothing 180$  mm = 3.000 Pieces/Reel  
 Reel  $\varnothing 180$  mm = 8.000 Pieces/Reel (2 mm Pitch)  
 Reel  $\varnothing 330$  mm = 10.000 Pieces/Reel

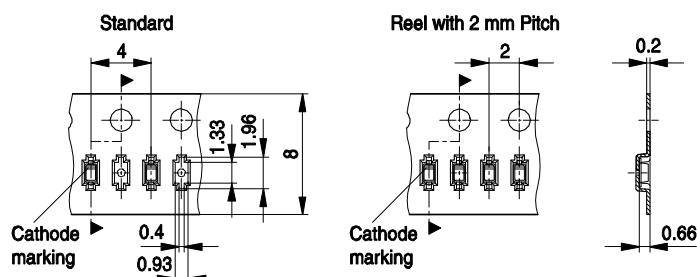

Package Outline



Foot Print



Marking Layout (Example)

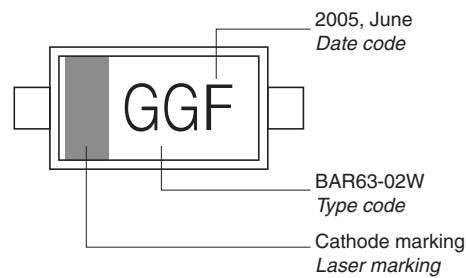

Standard Packing

Reel ø180 mm = 3.000 Pieces/Reel  
 Reel ø180 mm = 8.000 Pieces/Reel (2 mm Pitch)  
 Reel ø330 mm = 10.000 Pieces/Reel



Date Code marking for discrete packages with one digit (SCD80, SC79, SC75<sup>1)</sup>) CES-Code

Month	2003	2004	2005	2006	2007	2008	2009	2010	2011	2012	2013	2014
01	a	p	A	P	a	p	A	P	a	p	A	P
02	b	q	B	Q	b	q	B	Q	b	q	B	Q
03	c	r	C	R	c	r	C	R	c	r	C	R
04	d	s	D	S	d	s	D	S	d	s	D	S
05	e	t	E	T	e	t	E	T	e	t	E	T
06	f	u	F	U	f	u	F	U	f	u	F	U
07	g	v	G	V	g	v	G	V	g	v	G	V
08	h	x	H	X	h	x	H	X	h	x	H	X
09	j	y	J	Y	j	y	J	Y	j	y	J	Y
10	k	z	K	Z	k	z	K	Z	k	z	K	Z
11	l	2	L	4	l	2	L	4	l	2	L	4
12	n	3	N	5	n	3	N	5	n	3	N	5

1) New Marking Layout for SC75, implemented at October 2005.

Package Outline



Foot Print

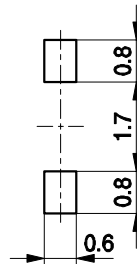

Marking Layout (Example)



Standard Packing

Reel ø180 mm = 3.000 Pieces/Reel  
 Reel ø330 mm = 10.000 Pieces/Reel



Package Outline



1) Lead width can be 0.6 max. in dambar area

Foot Print

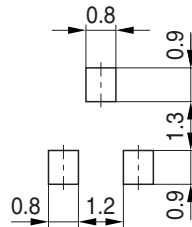

Marking Layout (Example)



Standard Packing

Reel  $\varnothing$ 180 mm = 3.000 Pieces/Reel  
 Reel  $\varnothing$ 330 mm = 10.000 Pieces/Reel

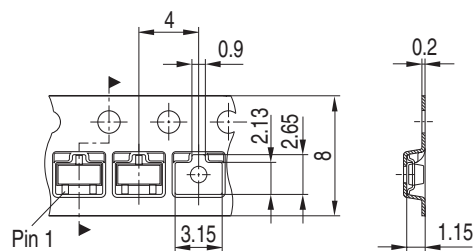

Package Outline



Foot Print



Marking Layout (Example)



Standard Packing

Reel  $\varnothing 180$  mm = 3.000 Pieces/Reel  
 Reel  $\varnothing 330$  mm = 10.000 Pieces/Reel

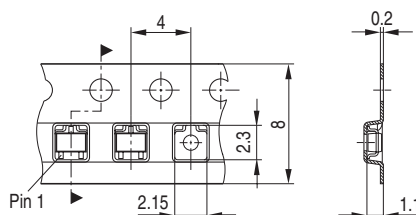

### Package Outline

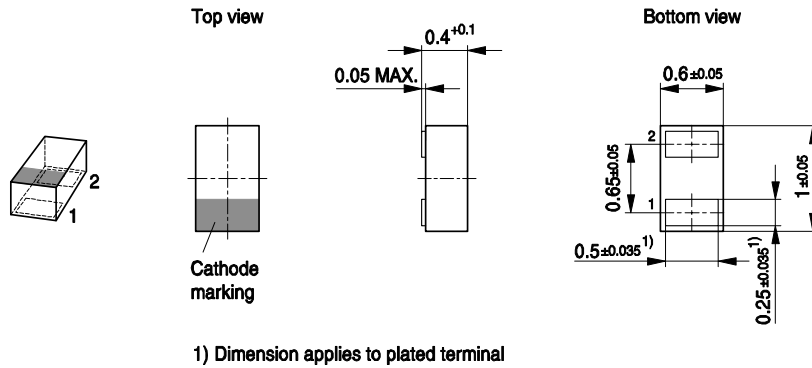

### Foot Print

For board assembly information please refer to Infineon website "Packages"

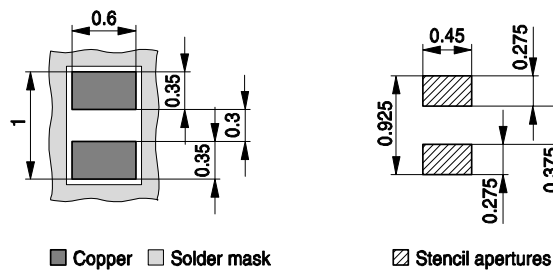

### Marking Layout (Example)

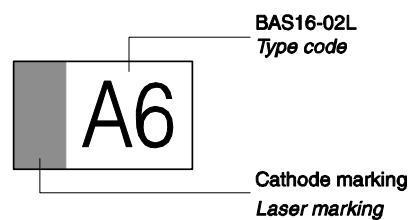

### Standard Packing

Reel  $\varnothing$ 180 mm = 15.000 Pieces/Reel  
 Reel  $\varnothing$ 330 mm = 50.000 Pieces/Reel (optional)

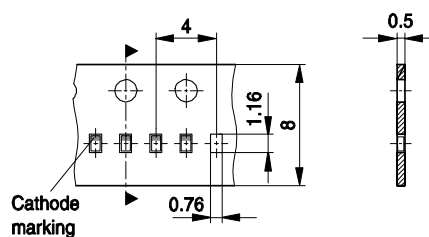

**Edition 2009-11-16**

**Published by  
Infineon Technologies AG  
81726 Munich, Germany**

**© 2009 Infineon Technologies AG  
All Rights Reserved.**

### **Legal Disclaimer**

The information given in this document shall in no event be regarded as a guarantee of conditions or characteristics. With respect to any examples or hints given herein, any typical values stated herein and/or any information regarding the application of the device, Infineon Technologies hereby disclaims any and all warranties and liabilities of any kind, including without limitation, warranties of non-infringement of intellectual property rights of any third party.

### **Information**

For further information on technology, delivery terms and conditions and prices, please contact the nearest Infineon Technologies Office ([www.infineon.com](http://www.infineon.com)).

### **Warnings**

Due to technical requirements, components may contain dangerous substances. For information on the types in question, please contact the nearest Infineon Technologies Office.

Infineon Technologies components may be used in life-support devices or systems only with the express written approval of Infineon Technologies, if a failure of such components can reasonably be expected to cause the failure of that life-support device or system or to affect the safety or effectiveness of that device or system. Life support devices or systems are intended to be implanted in the human body or to support and/or maintain and sustain and/or protect human life. If they fail, it is reasonable to assume that the health of the user or other persons may be endangered.

## Looking for pricing, stock, or lifecycle information?

Click below to explore more details on WIN SOURCE:

-  [View BBY53E6327 on WIN SOURCE](#)
-  [Infineon Technologies Information](#)

## Optimize Your Supply Chain with WIN SOURCE Solutions

-  Global Sourcing Solution
-  Obsolete Management
-  Cost Control Management
-  Shortage Management
-  Alternative Solution
-  Excess Inventory Management