



**THE DATASHEET OF
ECS-.327-12.5-12-TR**



The ultra-miniature ECX-12 is a very compact SMD Tuning Fork Crystal. The 2.0 x 1.2 x 0.6 mm ceramic package is ideal for mobile devices, IoT, real time clocks, and industrial applications.

ECX-12

32.768 KHz

SMD Tuning Fork Crystal

[Request a Sample](#)



- Low Power RTC Applications such as STM32 [AN2867](#)
- 2.0 x 1.2 mm Footprint
- Extended Temp. Range
- RoHS Compliant
- Applications: Automotive, COTS, Industrial, IOT

DIMENSIONS (mm)

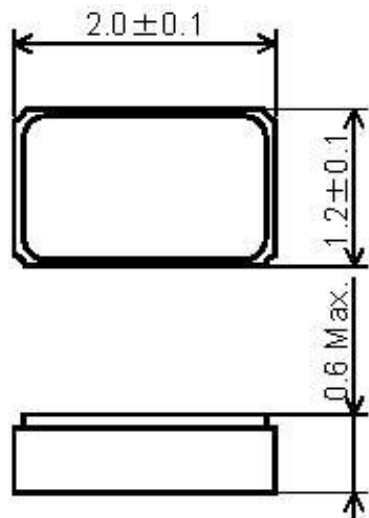
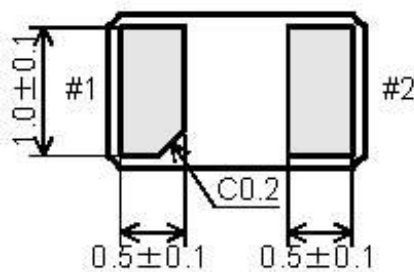

Figure 1) Top, Side, and Bottom views



PAD CONNECTIONS	
1	In/Out
2	Out/In

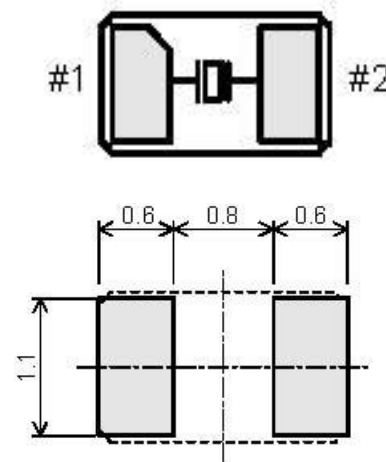

Figure 2) Suggested Land Pattern

OPERATING CONDITIONS / ELECTRICAL CHARACTERISTICS

PARAMETERS	CONDITIONS	ECX-12			UNITS
		MIN	TYP	MAX	
Frequency			32.768		KHz
Frequency Tolerance	@ +25°C			± 20 *	ppm
Load Capacitance	Specify in P/N		12.5		pF
Drive Level	DL		0.1	0.5	μW
Equivalent Series Resistance	R1			90K	Ω
Motional Capacitance			7.0		fF
Turnover Temperature		+20	+25	+30	°C
Temperature Coefficient		-0.02	-0.03	-0.040	ppm/°C ²
Shunt Capacitance	Co		1.3		pF
Aging (First Year)	@ +25°C ±3°C			±3	ppm
Operating Temperature	T _{opr}	-40		+85	°C
Storage Temperature	T _{stg}	-55		+125	°C

PART NUMBERING GUIDE: Example ECS-.327-12.5-12-TR

ECS - FREQUENCY ABBREVIATION	LOAD CAPACITANCE	PACKAGE	CUSTOM OPTIONS Tolerance	PACKAGING
ECS	.327 = 32.768 KHz 12.5 = 12.5 pF 9 = 9 pF 7 = 7 pF 6 = 6 pF	-12 = ECX-12	Blank = ±20 ppm * C = ± 10 ppm	TR = 3K/Reel TR9 = 9K/Reel

*Contact ECS for availability

POCKET TAPE DIMENSIONS (mm)

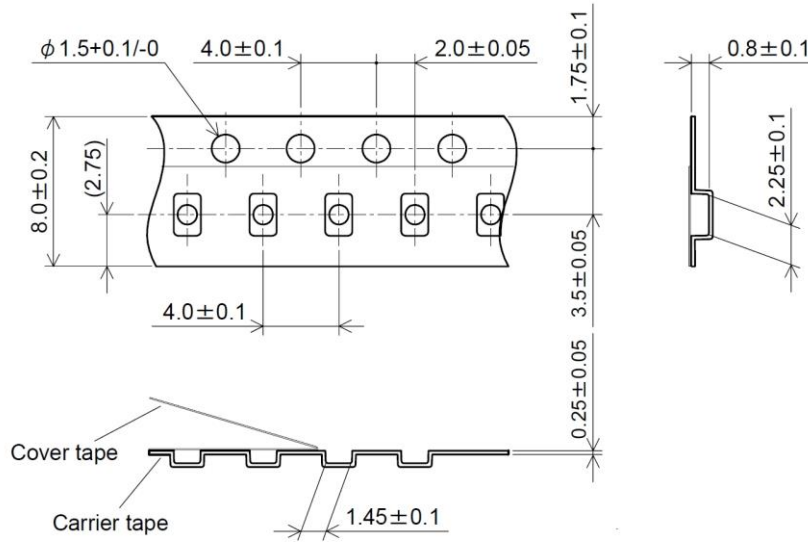

SOLDER PROFILE	
Peak solder Temp	+260°C Max 10 sec Max.
	2 Cycles Max.
	MSL 1, Lead Finish Au

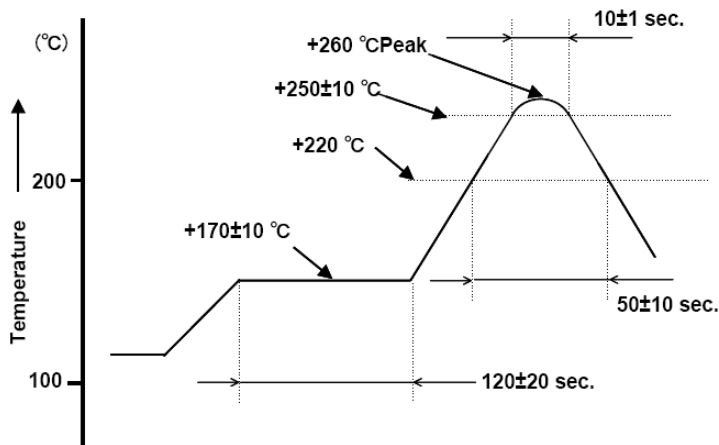



Figure 1) Suggested Reflow Profile

Looking for pricing, stock, or lifecycle information?

Click below to explore more details on WIN SOURCE:

-  [View ECS-.327-12.5-12-TR on WIN SOURCE](#)
-  [ECS Inc. Information](#)

Optimize Your Supply Chain with WIN SOURCE Solutions

-  Global Sourcing Solution
-  Obsolete Management
-  Cost Control Management
-  Shortage Management
-  Alternative Solution
-  Excess Inventory Management