



**THE DATASHEET OF
BBY51-03W**



Silicon Tuning Diode

- High Q hyperabrupt tuning diode
- Designed for low tuning voltage operation
- For VCO's in mobile communications equipment
- Pb-free (RoHS compliant) package



BBY51-02L
BBY51-02V
BBY51-02W
BBY51-03W

BBY51

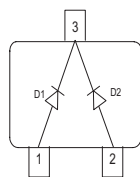
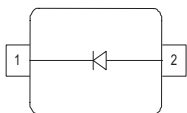

Type	Package	Configuration	Marking
BBY51	SOT23	common cathode	S3s
BBY51-02L	TSLP-2-1	single, leadless	ll
BBY51-02V	SC79	single	f
BBY51-02W*	SCD80	single	ll
BBY51-03W	SOD323	single	white H

* Not for new design

Maximum Ratings at $T_A = 25\text{ }^\circ\text{C}$, unless otherwise specified

Parameter	Symbol	Value	Unit
Diode reverse voltage	V_R	7	V
Forward current	I_F	20	mA
Operating temperature range	T_{op}	-55 ... 125	°C
Storage temperature	T_{stg}	-55 ... 150	

Electrical Characteristics at $T_A = 25\text{ }^\circ\text{C}$, unless otherwise specified

Parameter	Symbol	Values			Unit
		min.	typ.	max.	
DC Characteristics					
Reverse current $V_R = 6\text{ V}$ $V_R = 6\text{ V}, T_A = 85\text{ }^\circ\text{C}$	I_R	- -	- -	10 200	nA
AC Characteristics					
Diode capacitance $V_R = 1\text{ V}, f = 1\text{ MHz}$ $V_R = 2\text{ V}, f = 1\text{ MHz}$ $V_R = 3\text{ V}, f = 1\text{ MHz}$ $V_R = 4\text{ V}, f = 1\text{ MHz}$	C_T	5.05 3.4 2.7 2.5	5.4 4.2 3.5 3.1	5.75 5.2 4.6 3.7	pF
Capacitance ratio $V_R = 1\text{ V}, V_R = 4\text{ V}, f = 1\text{ MHz}$	C_{T1}/C_{T4}	1.55	1.75	2.2	
Capacitance difference $V_R = 1\text{ V}, V_R = 3\text{ V}, f = 1\text{ MHz}$	$C_{1V}-C_{3V}$	1.4	1.78	2.2	pF
Capacitance difference $V_R = 3\text{ V}, V_R = 4\text{ V}, f = 1\text{ MHz}$	$C_{3V}-C_{4V}$	0.3	0.5	0.7	
Series resistance $V_R = 1\text{ V}, f = 1\text{ GHz}$	r_S	-	0.37	-	Ω

Diode capacitance $C_T = f(V_R)$

$f = 1\text{MHz}$

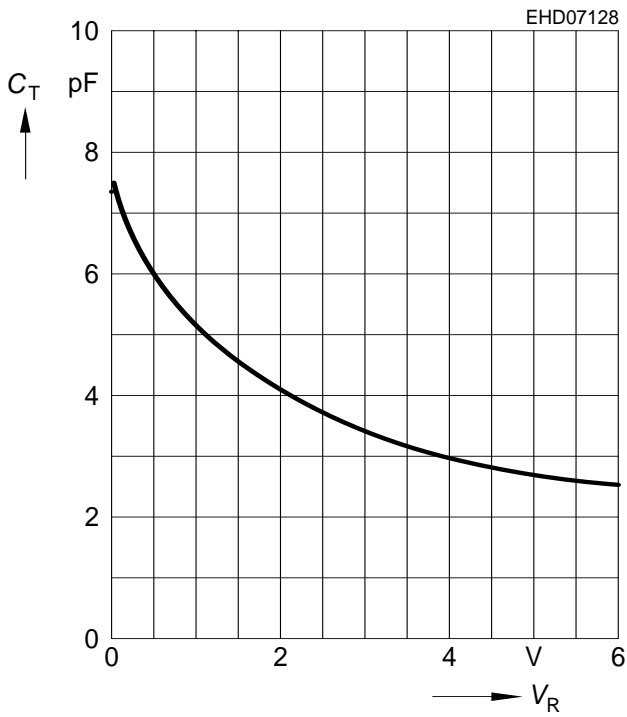

Temperature coefficient of the diode

capacitance $T_{Cc} = f(V_R)$

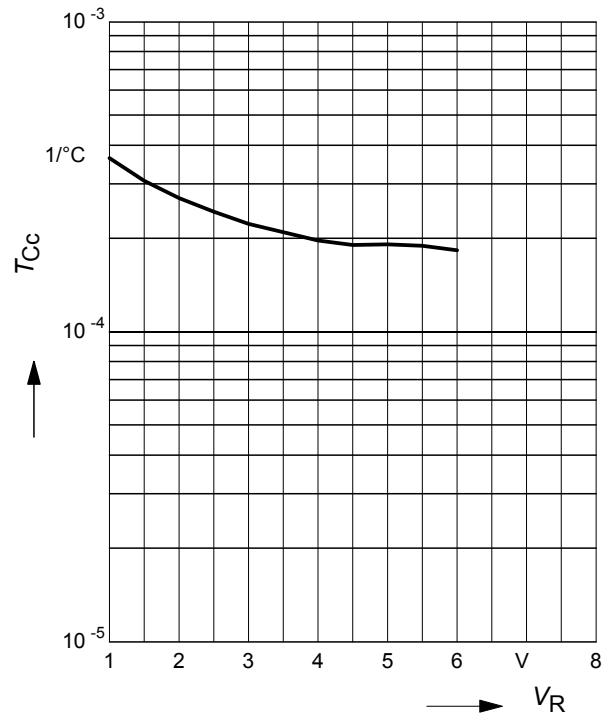

Package Outline



Foot Print

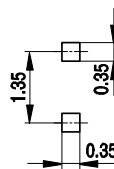

Marking Layout (Example)

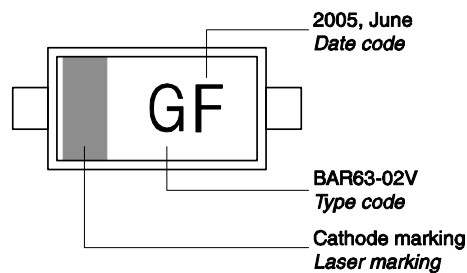

Standard Packing

- Reel \varnothing 180 mm = 3.000 Pieces/Reel
- Reel \varnothing 180 mm = 8.000 Pieces/Reel (2 mm Pitch)
- Reel \varnothing 330 mm = 10.000 Pieces/Reel

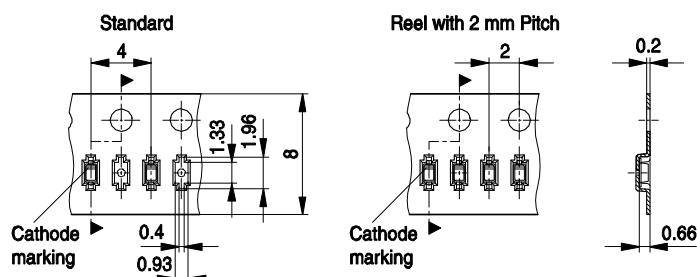

Package Outline

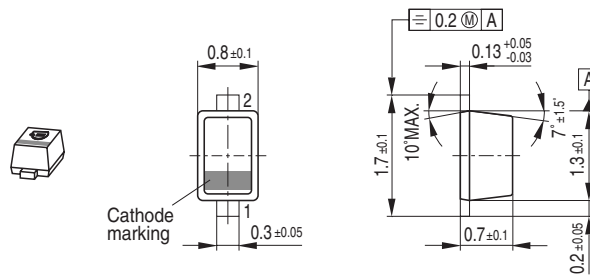

Foot Print

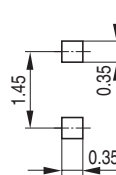

Marking Layout (Example)



Standard Packing

Reel \varnothing 180 mm = 3.000 Pieces/Reel
 Reel \varnothing 180 mm = 8.000 Pieces/Reel (2 mm Pitch)
 Reel \varnothing 330 mm = 10.000 Pieces/Reel



Date Code marking for discrete packages with one digit (SCD80, SC79, SC75¹⁾) CES-Code

Month	2003	2004	2005	2006	2007	2008	2009	2010	2011	2012	2013	2014
01	a	p	A	P	a	p	A	P	a	p	A	P
02	b	q	B	Q	b	q	B	Q	b	q	B	Q
03	c	r	C	R	c	r	C	R	c	r	C	R
04	d	s	D	S	d	s	D	S	d	s	D	S
05	e	t	E	T	e	t	E	T	e	t	E	T
06	f	u	F	U	f	u	F	U	f	u	F	U
07	g	v	G	V	g	v	G	V	g	v	G	V
08	h	x	H	X	h	x	H	X	h	x	H	X
09	j	y	J	Y	j	y	J	Y	j	y	J	Y
10	k	z	K	Z	k	z	K	Z	k	z	K	Z
11	l	2	L	4	l	2	L	4	l	2	L	4
12	n	3	N	5	n	3	N	5	n	3	N	5

1) New Marking Layout for SC75, implemented at October 2005.

Package Outline

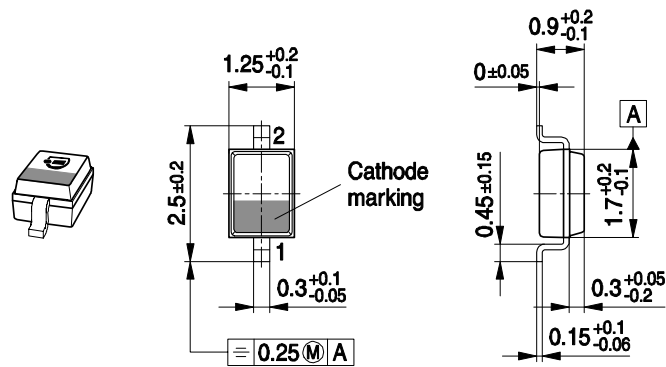

Foot Print

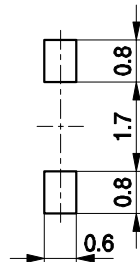

Marking Layout (Example)

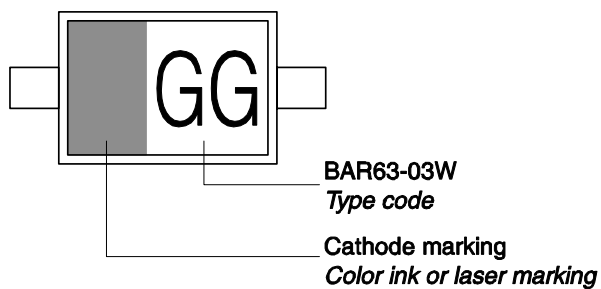

Standard Packing

Reel ø180 mm = 3.000 Pieces/Reel
 Reel ø330 mm = 10.000 Pieces/Reel

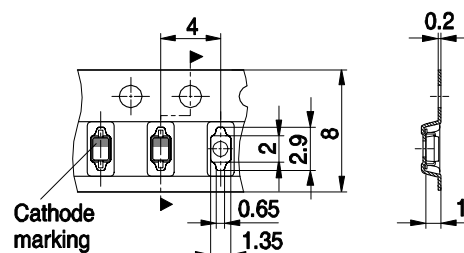

Package Outline

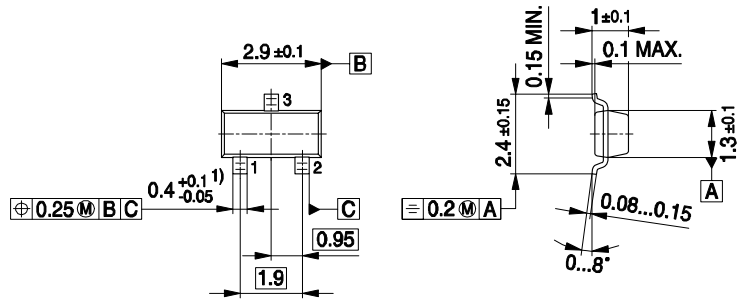

1) Lead width can be 0.6 max. in dambar area

SOT23-PO V08

Foot Print

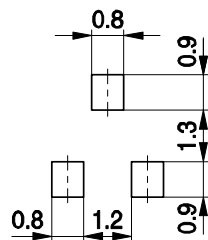

SOT23-FPR V08

Marking Layout

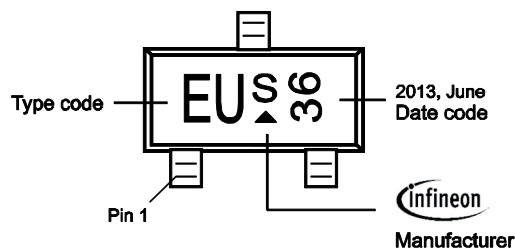

Standard Packing

Reel o 180 mm: 3.000 Pieces / Reel
 Reel o 330 mm = 10.000 Pieces / Reel

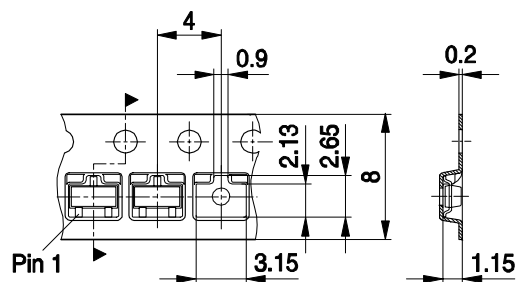

SOT23-TP V02

Package Outline

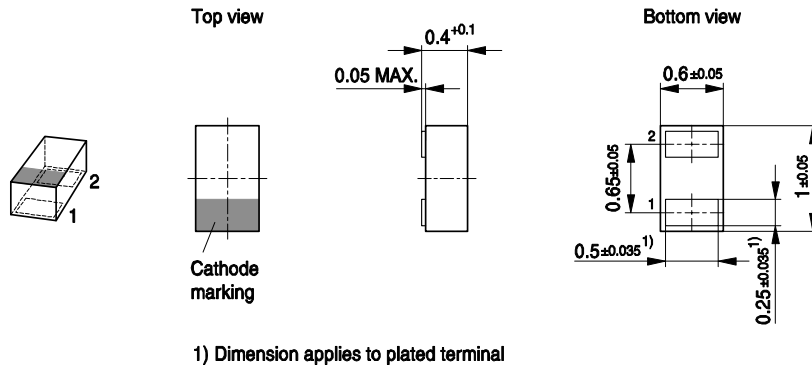

Foot Print

For board assembly information please refer to Infineon website "Packages"

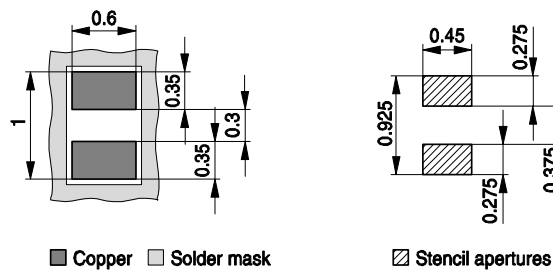

Marking Layout (Example)

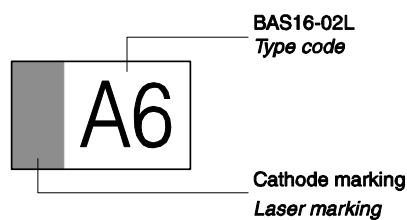

Standard Packing

Reel \varnothing 180 mm = 15.000 Pieces/Reel
 Reel \varnothing 330 mm = 50.000 Pieces/Reel (optional)

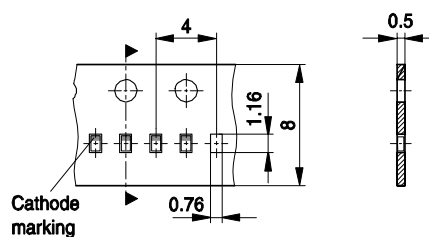

Edition 2009-11-16

**Published by
Infineon Technologies AG
81726 Munich, Germany**

**© 2009 Infineon Technologies AG
All Rights Reserved.**

Legal Disclaimer

The information given in this document shall in no event be regarded as a guarantee of conditions or characteristics. With respect to any examples or hints given herein, any typical values stated herein and/or any information regarding the application of the device, Infineon Technologies hereby disclaims any and all warranties and liabilities of any kind, including without limitation, warranties of non-infringement of intellectual property rights of any third party.

Information

For further information on technology, delivery terms and conditions and prices, please contact the nearest Infineon Technologies Office (www.infineon.com).



Warnings

Due to technical requirements, components may contain dangerous substances. For information on the types in question, please contact the nearest Infineon Technologies Office.

Infineon Technologies components may be used in life-support devices or systems only with the express written approval of Infineon Technologies, if a failure of such components can reasonably be expected to cause the failure of that life-support device or system or to affect the safety or effectiveness of that device or system. Life support devices or systems are intended to be implanted in the human body or to support and/or maintain and sustain and/or protect human life. If they fail, it is reasonable to assume that the health of the user or other persons may be endangered.

Looking for pricing, stock, or lifecycle information?

Click below to explore more details on WIN SOURCE:

-  [View BBY51-03W on WIN SOURCE](#)
-  [Infineon Technologies Information](#)

Optimize Your Supply Chain with WIN SOURCE Solutions

-  Global Sourcing Solution
-  Obsolete Management
-  Cost Control Management
-  Shortage Management
-  Alternative Solution
-  Excess Inventory Management