

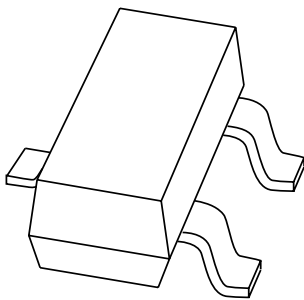

**THE DATASHEET OF
BBY31 T/R**



DATA SHEET



BBY31

UHF variable capacitance diode

Product specification
Supersedes data of November 1993

1996 May 03

UHF variable capacitance diode

BBY31

FEATURES

- Excellent linearity
- Small plastic SMD package
- C28: 1.9 pF; ratio: 8.3.

APPLICATIONS

- Electronic tuning in UHF television tuners
- VCO.

DESCRIPTION

The BBY31 is a variable capacitance diode, fabricated in planar technology, and encapsulated in the SOT23 small plastic SMD package.

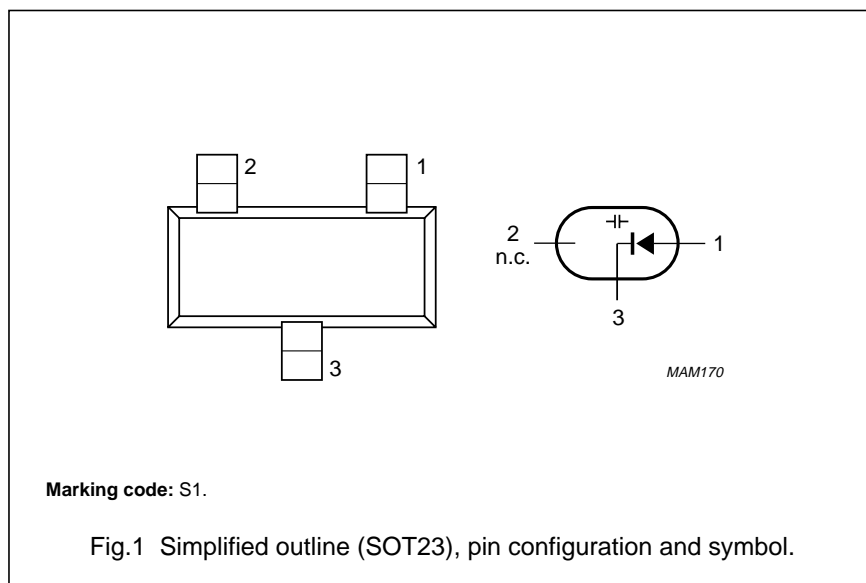

LIMITING VALUES

In accordance with the Absolute Maximum Rating System (IEC 134).

SYMBOL	PARAMETER	MIN.	MAX.	UNIT
V_R	continuous reverse voltage	–	30	V
I_F	continuous forward current	–	20	mA
T_{stg}	storage temperature	–55	+150	°C
T_j	operating junction temperature	–55	+125	°C

ELECTRICAL CHARACTERISTICS

$T_j = 25\text{ °C}$; unless otherwise specified.

SYMBOL	PARAMETER	CONDITIONS	MIN.	TYP.	MAX.	UNIT
I_R	reverse current	$V_R = 28\text{ V}$; see Fig.3	–	–	10	nA
		$V_R = 28\text{ V}$; $T_j = 85\text{ °C}$; see Fig.3	–	–	200	nA
r_s	diode series resistance	$f = 470\text{ MHz}$; note 1	–	–	1.2	Ω
C_d	diode capacitance	$V_R = 1\text{ V}$; $f = 1\text{ MHz}$; see Figs 2 and 4	–	16.5	–	pF
		$V_R = 28\text{ V}$; $f = 1\text{ MHz}$; see Figs 2 and 4	1.6	–	2	pF
$\frac{C_{d(1V)}}{C_{d(28V)}}$	capacitance ratio	$f = 1\text{ MHz}$	–	8.3	–	

Note

1. V_R is the value at which $C_d = 9\text{ pF}$.

UHF variable capacitance diode

BBY31

GRAPHICAL DATA

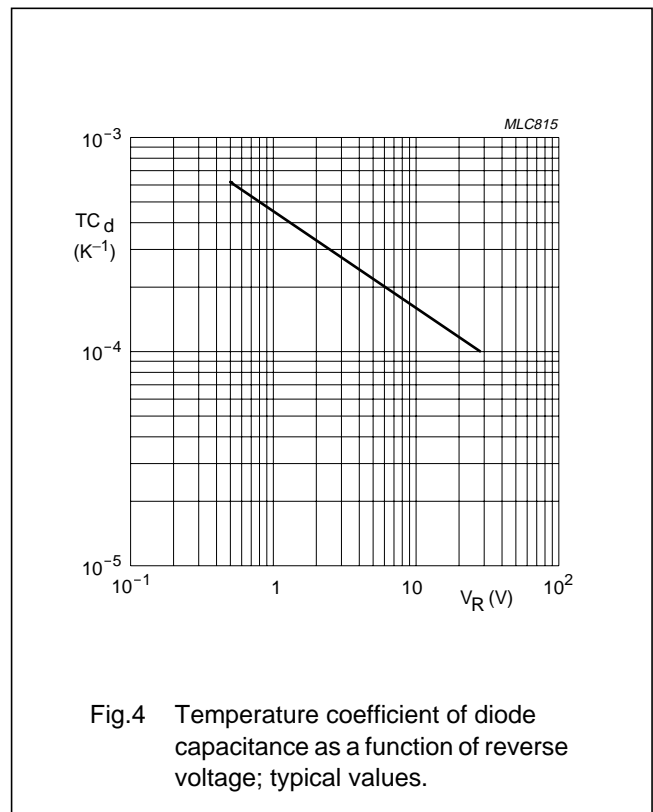
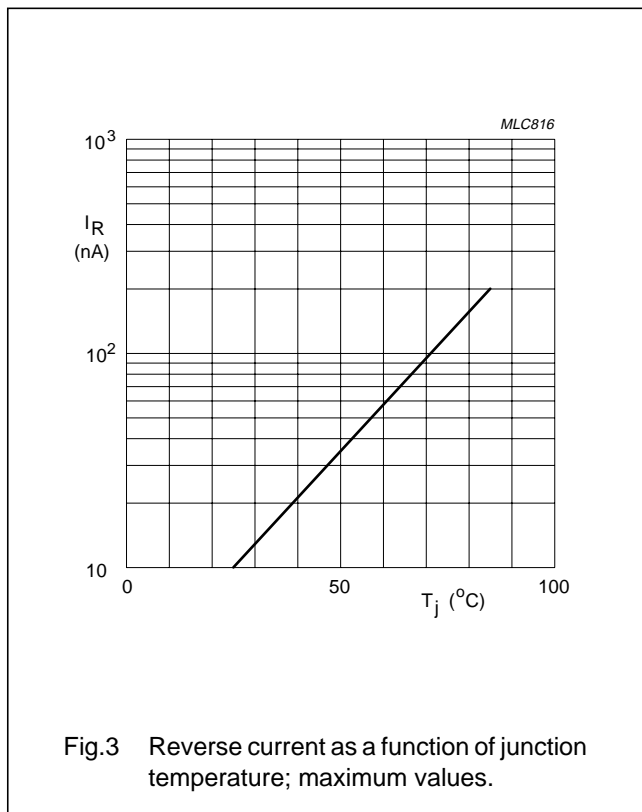
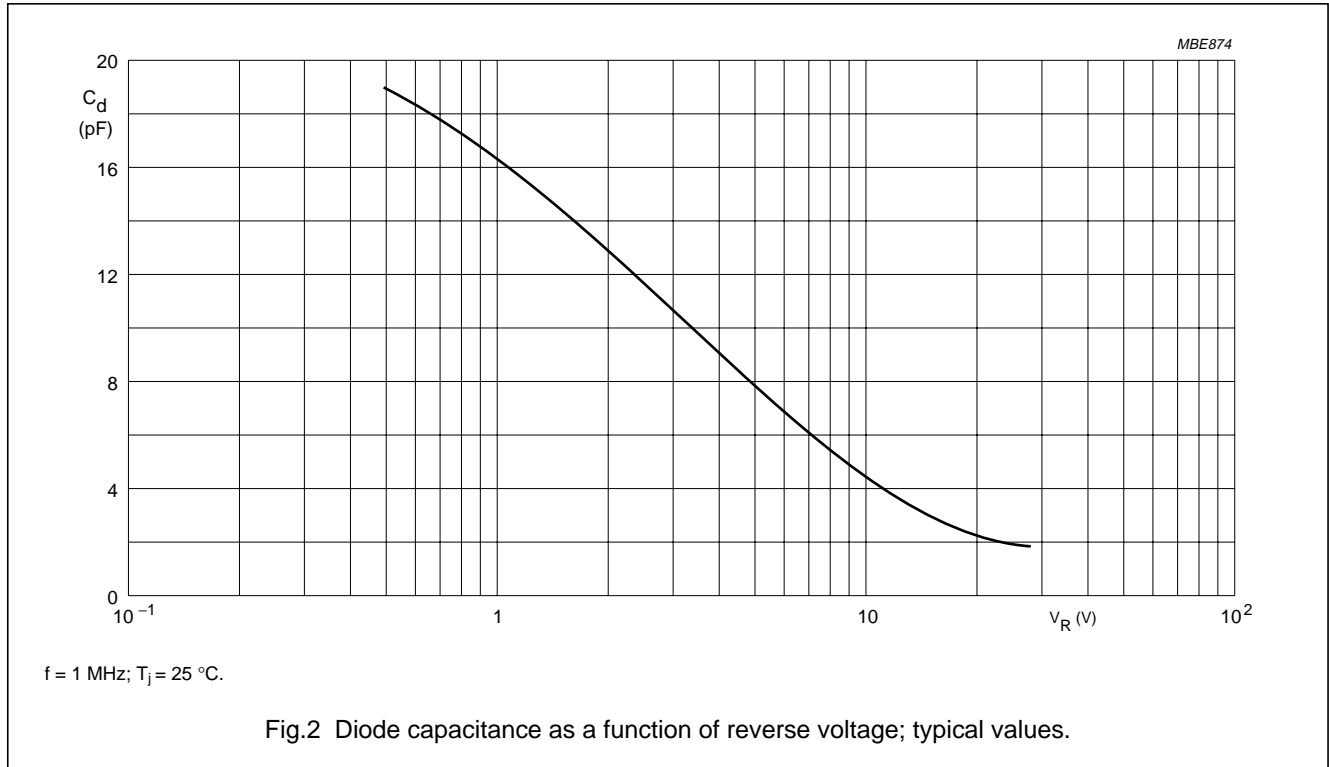

UHF variable capacitance diode

BBY31

PACKAGE OUTLINE

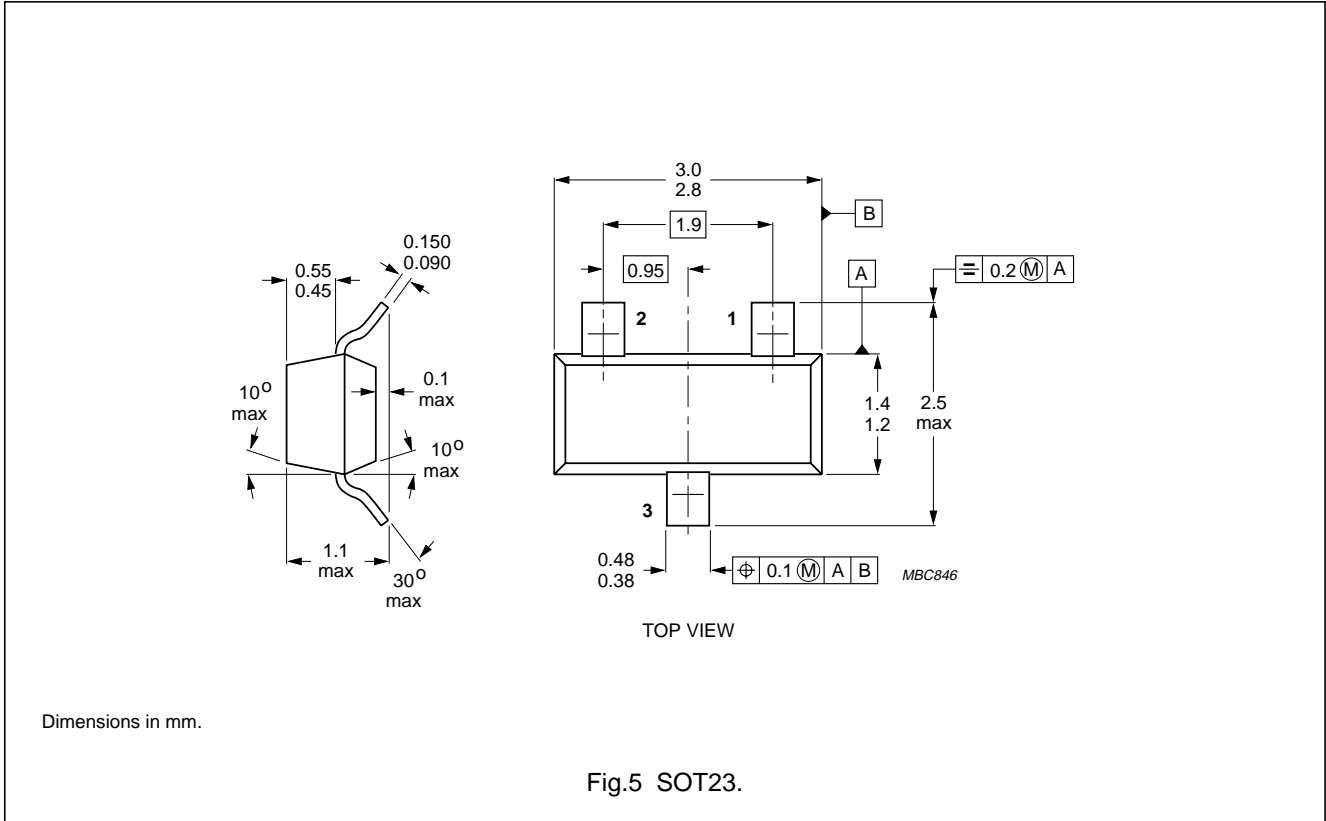

DEFINITIONS



Data sheet status	
Objective specification	This data sheet contains target or goal specifications for product development.
Preliminary specification	This data sheet contains preliminary data; supplementary data may be published later.
Product specification	This data sheet contains final product specifications.
Limiting values	
Limiting values given are in accordance with the Absolute Maximum Rating System (IEC 134). Stress above one or more of the limiting values may cause permanent damage to the device. These are stress ratings only and operation of the device at these or at any other conditions above those given in the Characteristics sections of the specification is not implied. Exposure to limiting values for extended periods may affect device reliability.	
Application information	
Where application information is given, it is advisory and does not form part of the specification.	

LIFE SUPPORT APPLICATIONS

These products are not designed for use in life support appliances, devices, or systems where malfunction of these products can reasonably be expected to result in personal injury. Philips customers using or selling these products for use in such applications do so at their own risk and agree to fully indemnify Philips for any damages resulting from such improper use or sale.

Looking for pricing, stock, or lifecycle information?

Click below to explore more details on WIN SOURCE:

-  [View BBY31 T/R on WIN SOURCE](#)
-  [NXP / Nexperia Information](#)

Optimize Your Supply Chain with WIN SOURCE Solutions

-  Global Sourcing Solution
-  Obsolete Management
-  Cost Control Management
-  Shortage Management
-  Alternative Solution
-  Excess Inventory Management