

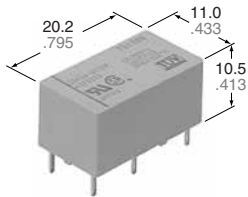

THE DATASHEET OF DSP1-L-DC5V

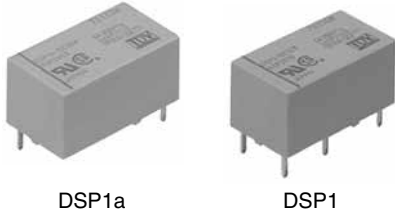



DSP2a mm inch

FEATURES

- Power types added to DS relay series
- High switching capacity:
1a: 8 A 250 V AC /
1a1b, 2a: 5 A 250 V AC
- High sensitivity: 190 mW pick-up power
- High contact welding resistance
- Latching types available
- High breakdown voltage 3,000 Vrms between contacts and coil 1,000 Vrms between open contacts Meeting FCC Part 68
- Sealed types are standard

About Cd-free contacts

We have introduced Cadmium free type products to reduce Environmental Hazardous Substances.
(The suffix "F" should be added to the part number)
(Note: The Suffix "F" is required only for 1 Form A 1 Form B contact type. The 1 Form A and 2 Form A contact type is originally Cadmium free, the suffix "F" is not required.)
Please replace parts containing Cadmium with Cadmium-free products and evaluate them with your actual application before use because the life of a relay depends on the contact material and load.

RoHS Directive compatibility information
<http://www.nais-e.com/>

SPECIFICATIONS (at 20°C 68°F)

Contact

Arrangement	1a	1a1b	2a
Contact material	AgSnO ₂ type		
Initial contact resistance, max. (By voltage drop 6 V DC 1A)	30 mΩ		
Nominal switching capacity	8A 250 VAC 5A 30 VDC	5A 250 VAC 5A 30 VDC	
Rating (resistive)	Max. switching power	2,000 VA 150 W	1,250 VA 150 W
	Max. switching voltage	250 V AC, 30 V DC	
	Max. switching current	8 A	5 A
	Min. switching capacity#1	10 mA, 5 V DC	
Expected life (min. operations)	Mechanical (at 180 cpm)	5×10 ⁷	
	Electrical	10 ⁵	

Coil (polarized) (at 20°C 68°F)

Minimum operating power	Single side stable	192 mW
	2 coil latching	192 mW
Nominal operating power	Single side stable	300 mW
	2 coil latching	300 mW

Note: All specifications are based on the condition of 25°C 77°F, 50% R.H. unless otherwise specified.

#1 This value can change due to the switching frequency, environmental conditions, and desired reliability level, therefore it is recommended to check this with the actual load.

Remarks

- * Specifications will vary with foreign standards certification ratings.
- *1 Measurement at same location as "Initial breakdown voltage" section
- *2 Detection current: 10mA
- *3 Excluding contact bounce time
- *4 Half-wave pulse of sine wave: 11ms; detection time: 10μs
- *5 Half-wave pulse of sine wave: 6ms
- *6 Detection time: 10μs
- *7 Refer to 6. Conditions for operation, transport and storage mentioned in AMBIENT ENVIRONMENT

Characteristics

Max. operating speed	30 cps. at rated load	
Initial insulation resistance*1	Min. 1,000 MΩ at 500 V DC	
Initial breakdown voltage*2	Between open contacts	1,000 Vrms
	Between contact sets	2,000 Vrms (1a1b, 2a)
	Between contacts and coil	3,000 Vrms
Surge voltage between contacts and coil	Min. 5,000 V	
Set time*3 (at nominal voltage)	Max. 10 ms (Approx. 5 ms)	
Reset time*3 (at nominal voltage)	Max. 10 ms (Approx. 4 ms)	
Operate time*3 (at nominal voltage)	Max. 10 ms (Approx. 5 ms)	
Release time(without diode)*3 (at nominal voltage)	Max. 5 ms (Approx. 4 ms)	
Temperature rise	Max. 40°C (1a1b type) Max. 55°C (1a, 2a types)	
Soldering temperature	250°C (10 s) 300°C (5 s), 350°C (3 s)	
Shock resistance	Functional*4	Min. 196 m/s ² {20 G}
	Destructive*5	Min. 980 m/s ² {100 G}
Vibration resistance	Functional*6	117.6 m/s ² {12 G}, 10 to 55 Hz at double amplitude of 2 mm
	Destructive	205.8 m/s ² {21 G}, 10 to 55 Hz at double amplitude of 3.5 mm
Conditions for operation, transport and storage*7 (Not freezing and condensing at low temperature)	-40°C to +65°C - 40°F 149°F	
Unit weight	Approx. 4.3 g .15 oz	

TYPICAL APPLICATIONS ORDERING INFORMATION

Office and industrial electronic devices
 • Terminal devices of information processing equipment, such as printer, data recorder.
 • Office equipment (copier, facsimile)
 • Measuring instruments
 • NC machines, temperature controllers and programmable logic controllers.

Ex. DSP 1 — L — DC12V — R — F

Contact arrangement	Operating function	Coil voltage	Polarity	Contact material
1: 1a1b 1a: 1a 2a: 2a	Nil: Single side stable L2: 2 coil latching	DC: 3, 5, 6, 9, 12, 24 V	Nil: Standard polarity R: Reverse polarity	• AgSnO ₂ type F: 1a1b Nil: 1a, 2a

(Notes) 1. Standard packing—Carton: 50 pcs.; Case: 500 pcs.
 UL/CSA, VDE approved type is standard.
 2. 1 coil latching type available.
 3. Please inquire about the previous products (Cadmium containing parts).
 (1 Form A 1 Form B type only)

TYPES AND COIL DATA (at 20°C 68°F)

Single side stable

Type	Part No.	Nominal voltage, V DC	Pick-up voltage, V DC (max.)	Drop-out voltage, V DC (min.)	Nominal operating current, mA	Nominal operating power, mW	Coil resistance, Ω (±10%)	Max. allowable voltage, at 50°C, V DC
Single side stable	DSP□-DC3V (-F)	3	2.4	0.3	100	300	30	3.9
	DSP□-DC5V (-F)	5	4.0	0.5	60	300	83	6.5
	DSP□-DC6V (-F)	6	4.8	0.6	50	300	120	7.8
	DSP□-DC9V (-F)	9	7.2	0.9	33.3	300	270	11.7
	DSP□-DC12V (-F)	12	9.6	1.2	25	300	480	15.6
	DSP□-DC24V (-F)	24	19.2	2.4	12.5	300	1,920	31.2

2 coil latching

Type	Part No.	Nominal voltage, V DC	Set voltage, V DC (max.)	Reset voltage, V DC (max.)	Nominal operating current, mA	Nominal operating power, mW	Coil resistance, Ω (±10%)	Max. allowable voltage, at 50°C, V DC
2 coil latching	DSP□-L2-DC3V (-F)	3	2.4	2.4	100	300	30	3.9
	DSP□-L2-DC5V (-F)	5	4.0	4.0	60	300	83	6.5
	DSP□-L2-DC6V (-F)	6	4.8	4.8	50	300	120	7.8
	DSP□-L2-DC9V (-F)	9	7.2	7.2	33.3	300	270	11.7
	DSP□-L2-DC12V (-F)	12	9.6	9.6	25.5	300	480	15.6
	DSP□-L2-DC24V (-F)	24	19.2	19.2	12.5	300	1,920	31.2

Notes: 1. Insert 1a, 1 or 2a in, □ for contact form required.
 2. The Suffix "F" is required only for DSP1-.

DIMENSIONS

mm inch

1a type (DSP1a)

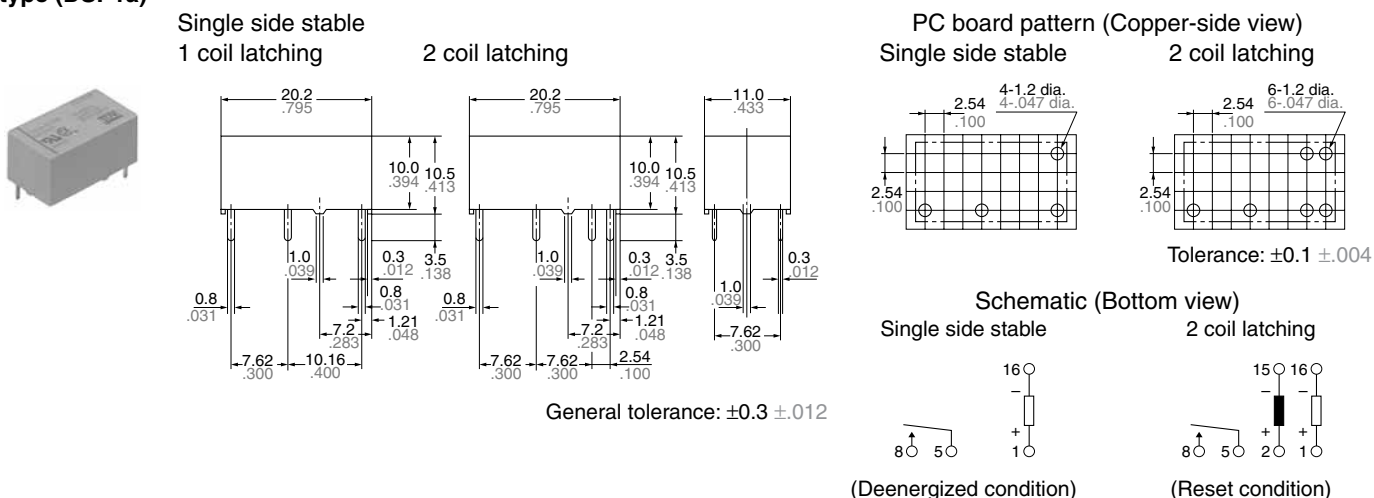

DSP

1a1b type (DSP1)

mm inch

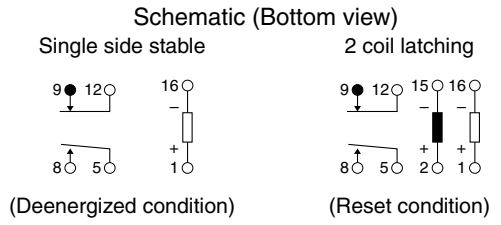
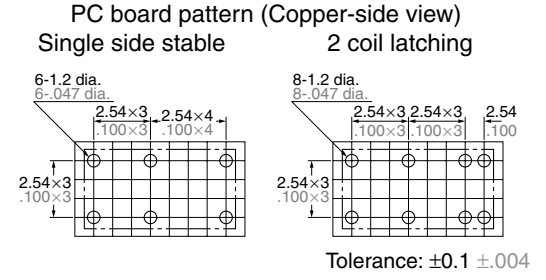
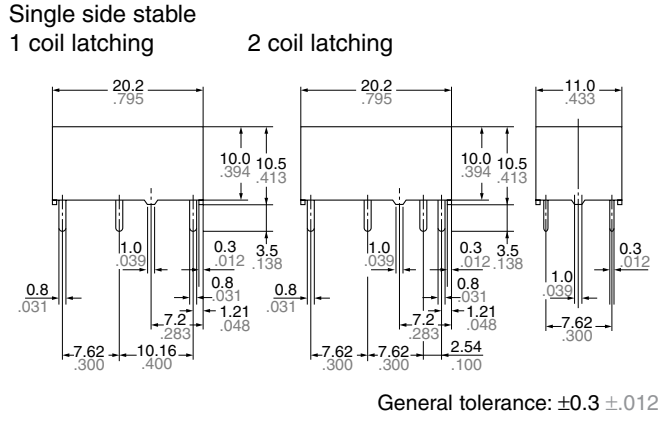

2a type (DSP2a)

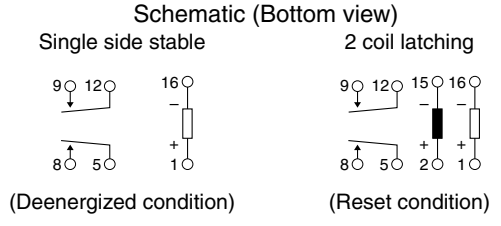
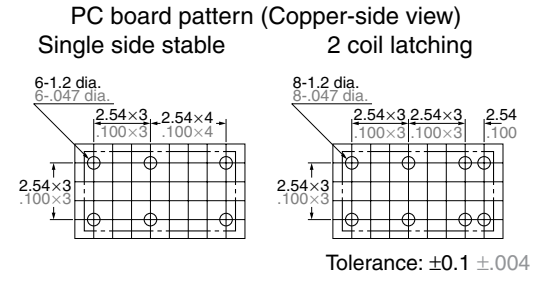
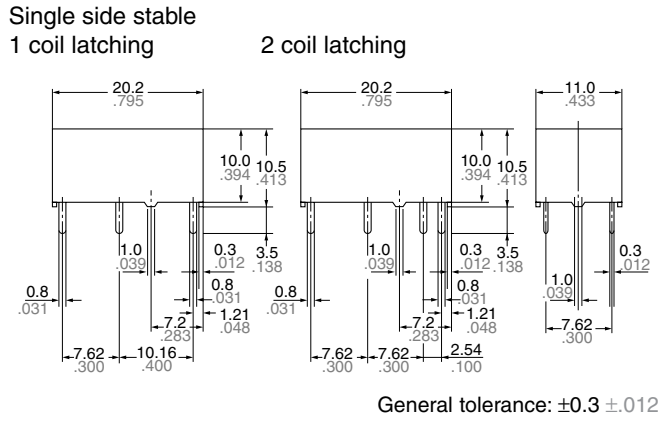

REFERENCE DATA

1. Max. switching capacity

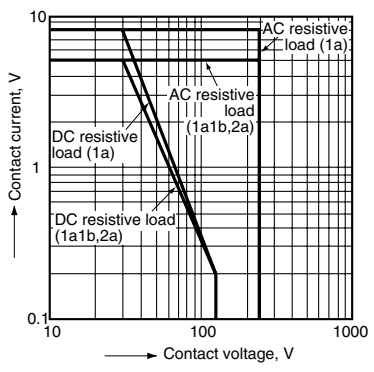

2.-(1) Life curve (1a1b type)

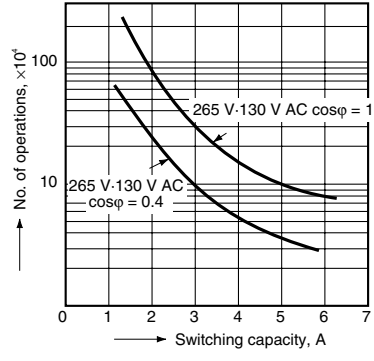

2.-(2) Life curve (1a1b type)

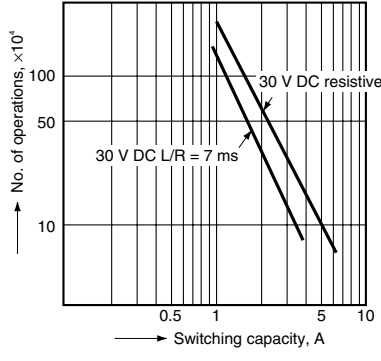

3.-(1) Coil temperature rise (1a type)

Sample: DSP1a-DC12V, 5 pcs.

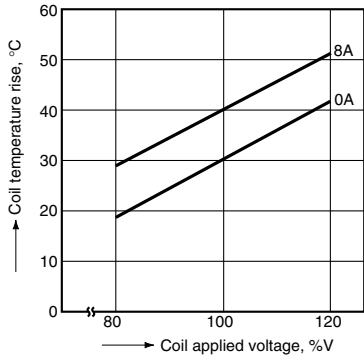

3.-(2) Coil temperature rise (1a1b type)

Sample: DSP1-DC12V, 5 pcs.

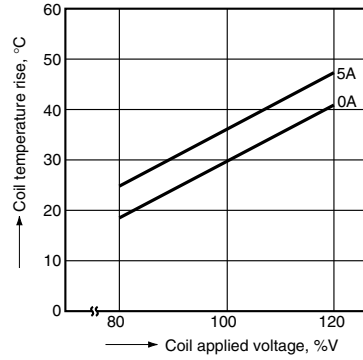

3.-(3) Coil temperature rise (2a type)

Sample: DSP2a-DC12V, 5 pcs.

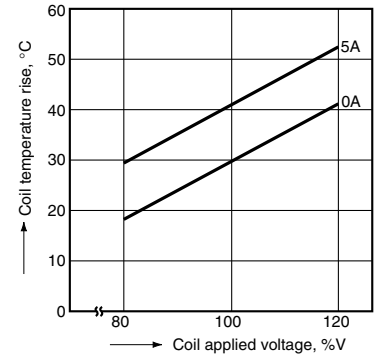

4.-(1) Operate & release time (without diode, 1a type)

Sample: DSP1a-DC12V, 5 pcs.

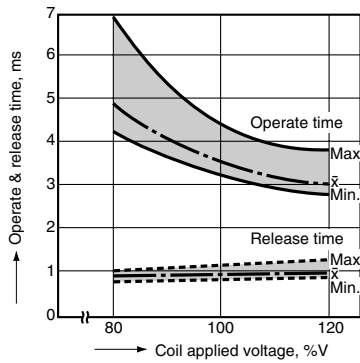

4.-(2) Operate & release time (without diode, 1a1b type)

Sample: DSP1-DC12V, 5 pcs.

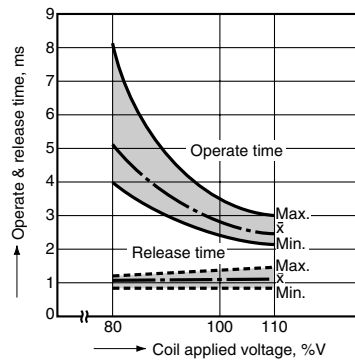

4.-(3) Operate & release time (without diode, 2a type)

Sample: DSP2a-DC12V, 5 pcs.)

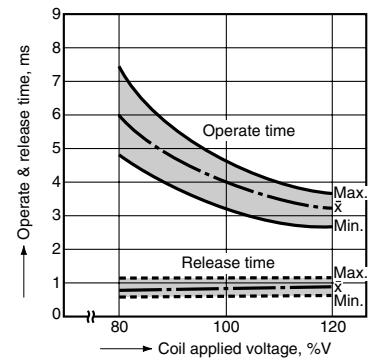

4.-(4) Operate & release time (with diode, 1a type)

Sample: DSP1a-DC12V, 5 pcs.

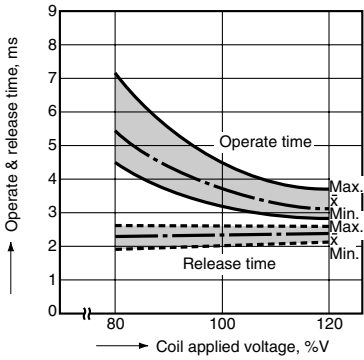

4.-(5) Operate & release time (with diode, 1a1b type)

Sample: DSP1-DC12V, 5 pcs.

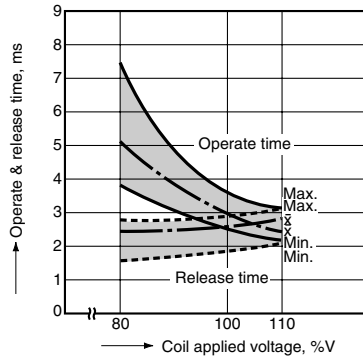

4.-(6) Operate & release time (with diode, 2a type)

Sample: DSP2a-DC12V, 5 pcs.

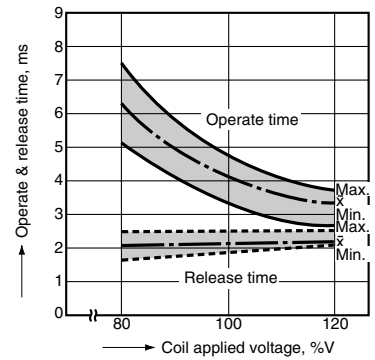

5.-(1) Change of pick-up and drop-out voltage (1a type)

Sample: DSP1a-DC12V, 5 pcs.

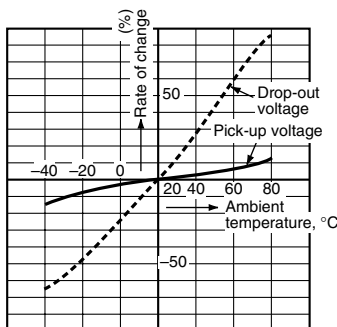

5.-(2) Change of pick-up and drop-out voltage (1a1b type)

Sample: DSP1-DC12V, 5 pcs.

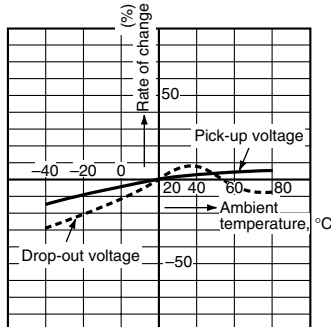

5.-(3) Change of pick-up and drop-out voltage (2a type)

Sample: DSP2a-DC12V, 5 pcs.

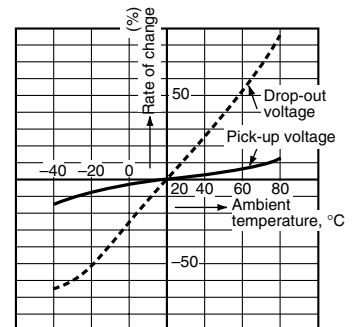

DSP

6.-(1) Influence of adjacent mounting (1a type)

Sample: DSP1a-DC12V, 5 pcs.

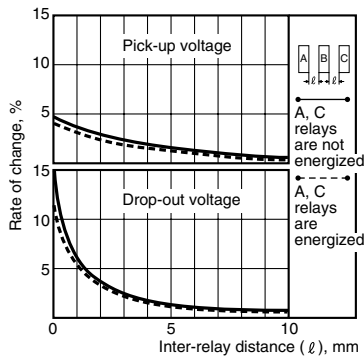

6.-(2) Influence of adjacent mounting (1a1b type)

Sample: DSP1-DC12V, 5 pcs.

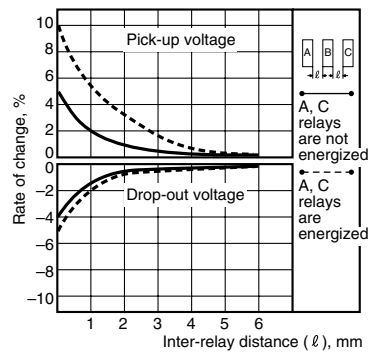

6.-(3) Influence of adjacent mounting (2a type)

Sample: DSP2a-DC12V, 5 pcs.

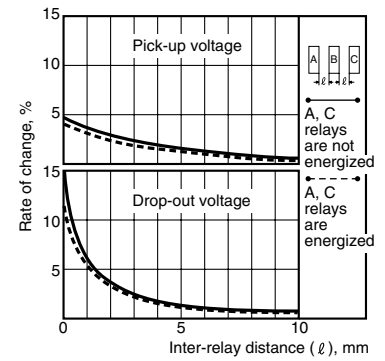

NOTES

Soldering should be done under the following conditions:

250°C 482°F within 10 s

300°C 572°F within 5 s

350°C 662°F within 3 s

For Cautions for Use, see Relay Technical Information

SOCKETS FOR DSP RELAYS

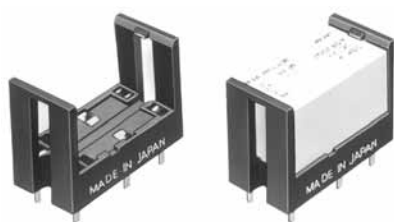

TYPES AND APPLICABLE RELAYS

Applicable relays	For DSP1a		For DSP1a, DSP1, DSP2a	
	DSP1a-PS	DSP1a-PSL2	DSP2a-PS	DSP2a-PSL2
DSP1a relays	OK	OK	OK	OK
DSP1a-L2 relays		OK		OK
DSP1 relays			OK	OK
DSP1-L2 relays				OK
DSP2a relays			OK	OK
DSP2a-L2 relays				OK

SPECIFICATIONS

Item	Specifications
Breakdown voltage	3,000 Vrms between terminals (Except for the portion between coil terminals)
Insulation resistance	1,000 MΩ between terminals at 500 V
Heat resistance	150°C for 1 hour
Max. continuous current	1a: 8 A 2a: 5 A

DIMENSIONS

mm inch

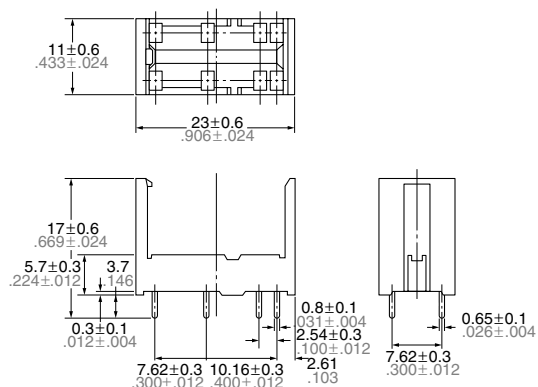

PC board pattern (Copper-side view)
DSP1a-PS, DSP1a-PSL2 DSP2a-PS, DSP2a-PSL2

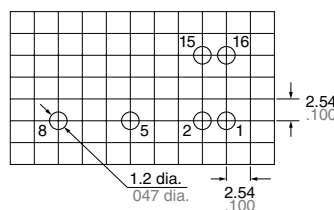

Terminal No.2 and 15 are for DSP1a-PSL2 only.

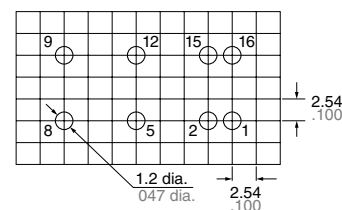

Terminal No.2 and 15 are for DSP2a-PSL2 only.

FIXING AND REMOVAL METHOD

1. Match the direction of relay and socket.

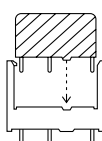

2. Both ends of relays are fixed so surely that the socket hooks on the top surface of relays.

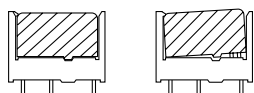

Good

No good

3. Remove the relay, applying force in the direction shown below.

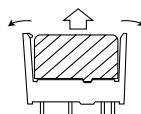

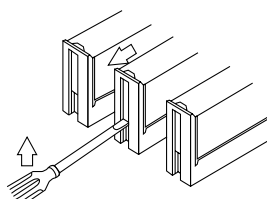

4. In case there is not enough space for finger to pick relay up, use screw drivers in the way shown below.



Looking for pricing, stock, or lifecycle information?

Click below to explore more details on WIN SOURCE:

-  [View DSP1-L-DC5V on WIN SOURCE](#)
-  [Panasonic Information](#)

Optimize Your Supply Chain with WIN SOURCE Solutions

-  Global Sourcing Solution
-  Obsolete Management
-  Cost Control Management
-  Shortage Management
-  Alternative Solution
-  Excess Inventory Management