

FEATURES

- Power-fail detector for personal computers and workstations
- Connects directly to popular personal computer chip sets
- On chip 32.768 kHz oscillator for real time clock
- Provides battery backup power to clock chip
- Pushbutton reset input
- Accurate 5% or 10% +5-volt power supply monitoring
- Complementary outputs for reset, power-fail, and low battery
- Provides for reset pulse width of either 95 ms or 190 ms
- Eliminates the need for discrete components
- Low-power CMOS circuitry
- 16-pin DIP or SOIC surface mount package
- 0°C to 70°C operation

PIN ASSIGNMENT

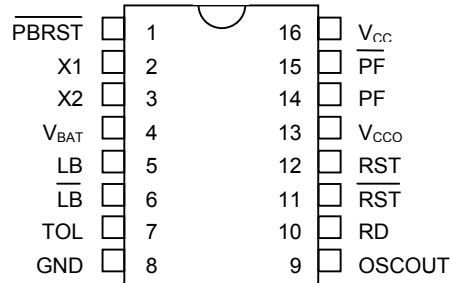

16-Pin DIP (300-mil)
See Mech. Drawings Section

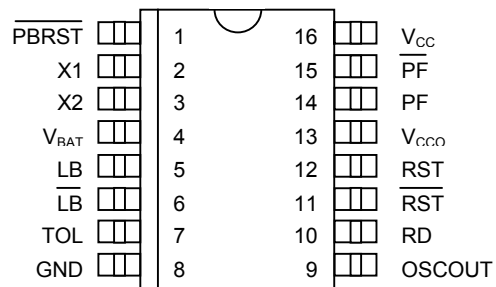

16-Pin SOIC (300-mil)
See Mech. Drawings Section

PIN DESCRIPTION

- PBRST - Pushbutton Reset Input
- X1, X2 - Crystal Inputs
- VBAT - Battery Input
- LB, LB - Low Battery Outputs
- RST, RST - Reset Outputs
- RD - Reset Duration
- TOL - Selects 5% Or 10% Detection
- GND - Ground
- OSCOUT - Oscillator Out
- VCCO - Switched Power Out
- PF, PF - Power-Fail Outputs
- VCC - +5-Volt Power In

DESCRIPTION

The DS1632 PC Power-Fail and Reset Controller is designed to do various functions involving battery backup and other functions typically accomplished with discrete components. The DS1632 provides a 32.768 kHz battery-backed crystal oscillator and switched V_{CC}/V_{BAT} power via V_{CCO} for the real time clock function located in accompanying chip sets. In addition, the DS1632 provides for reset on both

power-up and via pushbutton input, power-fail status signals for the processor, and low battery warning signals. The DS1632 is capable of detecting power failure at both the 5% and 10% power supply tolerances, and the reset pulse width can be set for either 95 ms or 190 ms. The device is designed to connect directly to popular laptop and notebook chip sets which eliminates the need for discrete components and reduces cost.

BLOCK DIAGRAM Figure 1

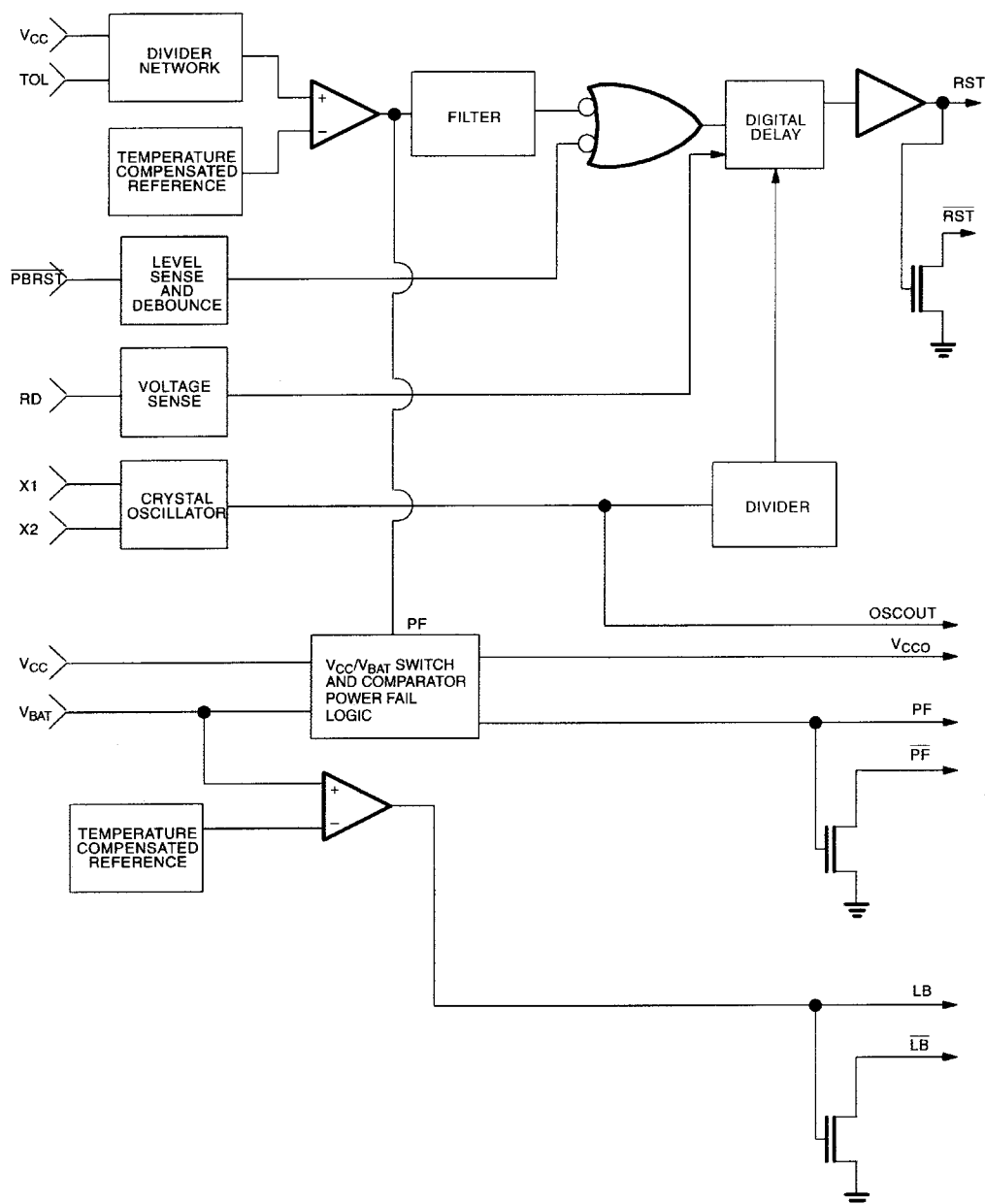

OPERATION - CRYSTAL OSCILLATOR SECTION

The DS1632 crystal oscillator is designed to be hooked directly to a 32.768 kHz crystal. By using the Daiwa Part No. DT26S, Seiko Part No. DS-VT-200 or equivalent, the oscillator will be accurate enough to run a real time clock to within ± 2 minutes per month. If another crystal is to be selected, it should have a specified load capacitance (C_L) of 6 pF. The crystal oscillator will run as long as either V_{CC} or V_{BAT} is present, providing that V_{BAT} is greater than 2.3V. The oscillator output provides a rail to rail swing with regards to V_{CC} or V_{BAT} , whichever is greater. The crystal oscillator is also used internally as a time base.

OPERATION – POWER-FAIL, BATTERY BACKUP

The DS1632 provides a switch to direct power from the battery (V_{BAT}) or the incoming supply (V_{CC}), depending on which is greater. This switch has a voltage drop of less than 0.3 volts. The V_{CC} input is constantly monitored by a precision comparator for an out-of-tolerance condition. When such a condition occurs, the power-fail signals are driven to their active state immediately. The reset signals are also driven active, but this action is delayed by a time determined by the level of the input on the reset duration pin (RD). If RD is tied to ground then reset signals will become active after 9 ms. If RD is tied to V_{CC} , then reset signals will become active after 18 ms. Once active, both the reset signals and the power-fail signals will remain active as long as a (V_{CC}) out-of-tolerance condition persists. If an out-of-tolerance condition is not long enough to activate the reset signals, then only the power-fail signals would be affected. When power returns to within nominal limits the power-fail signals will return immediately to the inactive state. However, the reset signals remain in the active state for a time which is dependent on the state of the RD pin. If RD is tied to ground, the reset signals will remain active for 95 ms. If RD is tied to V_{CC} , then the reset signals will remain active for 190 ms after power is within nominal limits. The delay action on the reset signals allows time for the power supply and microprocessor clock oscillators to stabilize. The tolerance pin (TOL) selects the point at which power-fail detection occurs. With the tolerance pin grounded, power-fail detection occurs in the range of 4.75V to 4.5V. If the tolerance pin is connected to V_{CC} , then power-fail detection occurs in the range of 4.5V to 4.25V. During most power supply conditions the V_{CC} input will supply power to all functions within the chip and also to the V_{CCO} pin. The battery pin (V_{BAT}) only supplies power when V_{CC} is less than V_{BAT} . When V_{CC} is below the level of V_{BAT} only the V_{CCO} and the OSC OUT pin remain powered by V_{BAT} . All other outputs will be driven to ground when in a logic low state and will be driven to V_{CC} when in a logic high state. This is done to preserve battery capacity by avoiding battery drain resulting from loads on these outputs. The output ground level will be maintained for all levels of V_{CC} , even $V_{CC} = GND$. However, the output V_{CC} level will be maintained only for $V_{CC} > 2.0V$. Internal battery power consumption is less than 2 μA while V_{BAT} is supplying power. The external load on OSC OUT and V_{CCO} must be added to internal consumption to determine the total load on the battery.

OPERATION - PUSHBUTTON RESET

The DS1632 provides an input pin for direct connection to a pushbutton. The pushbutton reset input \overline{PBRST} requires an active low level input. While TTL levels are sufficient to properly activate this input, it has been primarily designed for contact closure. Internally, this input is debounced and timed such that RST and \overline{RST} signals of 95ms or 190 ms minimum are generated. If RD is tied to ground, then a reset pulse of 95 ms is generated. If RD is tied to V_{CC} then a reset pulse of 190 ms is generated. The delay time is started as the pushbutton reset input is released from low level.

OPERATION - LOW BATTERY WARNING

The DS1632 provides outputs which warn of a low battery condition. Whenever V_{CC} is within nominal limits, the V_{BAT} input is continuously monitored. If the V_{BAT} input is out of tolerance, the low battery outputs are driven to their active states, and will remain in the active state as long as V_{CC} is within nominal limits or until the battery input is restored to an in limit status. On power-up, if the V_{BAT} input is out of tolerance, the low battery outputs are not guaranteed active until power-fail is deactivated, but guaranteed active prior to reset inactive. When V_{CC} is below the V_{CC} fail trip point both LB and \overline{LB} will be driven to ground.

For application information, please reference Application Note 64, published separately.

ABSOLUTE MAXIMUM RATINGS*

Voltage on V _{CC} Pin Relative to Ground	-0.5V to +7.0V
Voltage on I/O Relative to Ground	-0.5V to V _{CC} + 0.5V
Operating Temperature	0°C to 70°C
Storage Temperature	-55°C to +125°C
Soldering Temperature	260°C for 10 seconds

* This is a stress rating only and functional operation of the device at these or any other conditions above those indicated in the operation sections of this specification is not implied. Exposure to absolute maximum rating conditions for extended periods of time may affect reliability.

RECOMMENDED DC OPERATING CONDITIONS (0°C to 70°C)

PARAMETER	SYMBOL	MIN	TYP	MAX	UNITS	NOTES
Supply Voltage	V _{CC}	4.5	5.0	5.5	V	1
$\overline{\text{PBRST}}$ Input High Level	V _{IH}	2.0		V _{CC} +0.3	V	1, 3
$\overline{\text{PBRST}}$ Input Low Level	V _{IL}	-0.3		+0.8	V	1, 3
Battery Supply Voltage	V _{BAT}	2.3	3.0	3.5	V	1

DC ELECTRICAL CHARACTERISTICS (0°C to 70°C; V_{CC}=4.5 to 5.5V)

PARAMETER	SYMBOL	MIN	TYP	MAX	UNITS	NOTES
Output Current @ 2.4V	I _{OH}	1			mA	5, 7
Output Current @ 0.4V	I _{OL}	4			mA	7
Output Voltage @ -500 μ A	V _{OH}	V _{CC} -0.5V	V _{CC} -0.1V		V	1, 6
Low Level @ RST	V _{OL}			0.4	V	1
Operating Current	I _{CC}		0.5	2.0	mA	2
V _{CC} Trip Point (TOL=GND)	V _{CC} TP	4.50	4.62	4.75	V	1
V _{CC} Trip Point (TOL=V _{CC})	V _{CC} TP	4.25	4.37	4.50	V	1
Battery Fail Trip Point	V _{BAT} TP	2.30	2.45	2.55	V	1
Supply Voltage Output	V _{CCO}	V _{CC} -0.3			V	
Supply Current Output	I _{CCO1}			100	mA	4

DC ELECTRICAL CHARACTERISTICS (0°C; V_{CC}=<V_{BAT})

PARAMETER	SYMBOL	MIN	TYP	MAX	UNITS	NOTES
Battery Current	I _{BAT}			2	μ A	
Battery Backup Current	I _{CCO2}			500	μ A	4

CAPACITANCE (t_A=25°C)

PARAMETER	SYMBOL	MIN	TYP	MAX	UNITS	NOTES
Input Capacitance	C _{IN}			5	pF	
Output Capacitance	C _{OUT}			7	pF	

AC ELECTRICAL CHARACTERISTICS(0°C to 70°C; $V_{CC}=5V \pm 10\%$)

PARAMETER	SYMBOL	MIN	TYP	MAX	UNITS	NOTES
$\overline{PBRST} = V_{IL}$	t_{PB}	t_{RPD}			ms	
Reset Pulse Width	t_{RST}	95		105	ms	RD=GND
Reset Pulse Width	t_{RST}	190		210	ms	RD= V_{CC}
Reset Active on Power-Up	t_{RPU}	95		105	ms	RD=GND
Reset Active on Power-Up	t_{RPU}	190		210	ms	RD= V_{CC}
Reset Active on Power-Down	t_{RPD}	9		11	ms	RD=GND
Reset Active on Power-Down	t_{RPD}	18		22	ms	RD= V_{CC}
V_{CC} Slew Rate Power-Down	t_F	300			μs	
V_{CC} Slew Rate Power-Down	t_{FB}	10			μs	
V_{CC} Slew Rate Power-Up	t_R	10			μs	

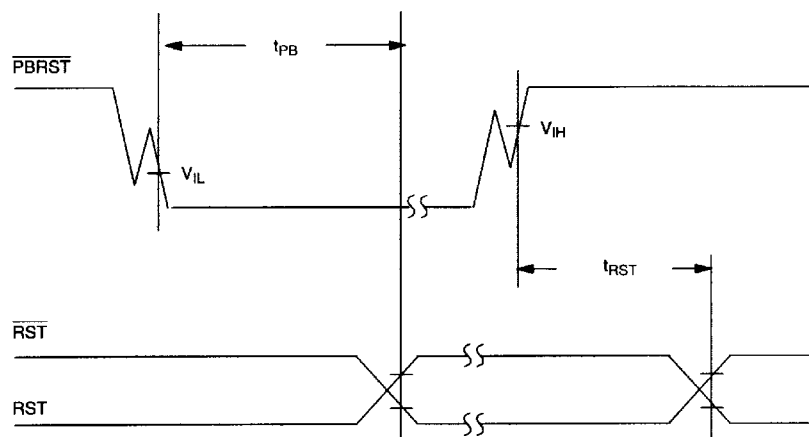
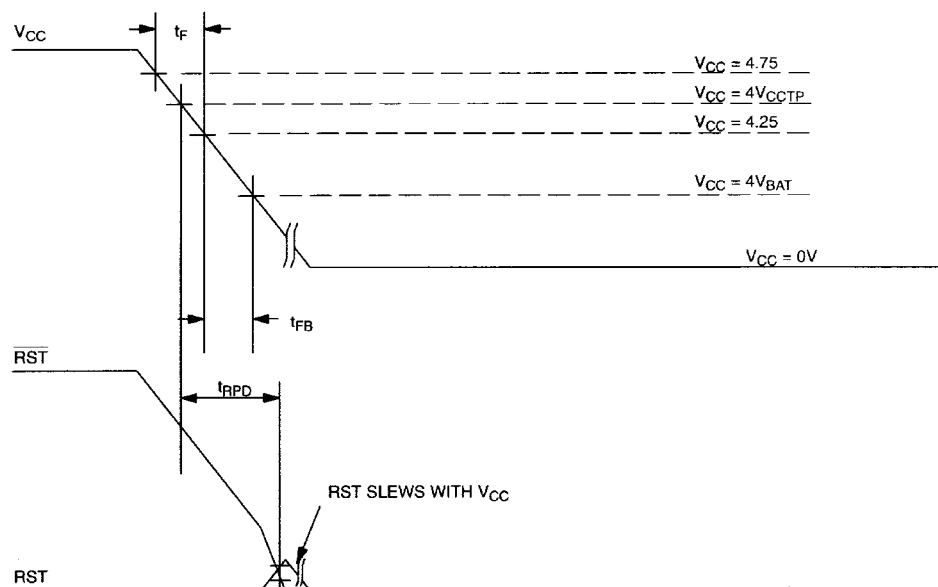
TIMING DIAGRAM: PUSHBUTTON RESET**TIMING DIAGRAM: POWER-DOWN**

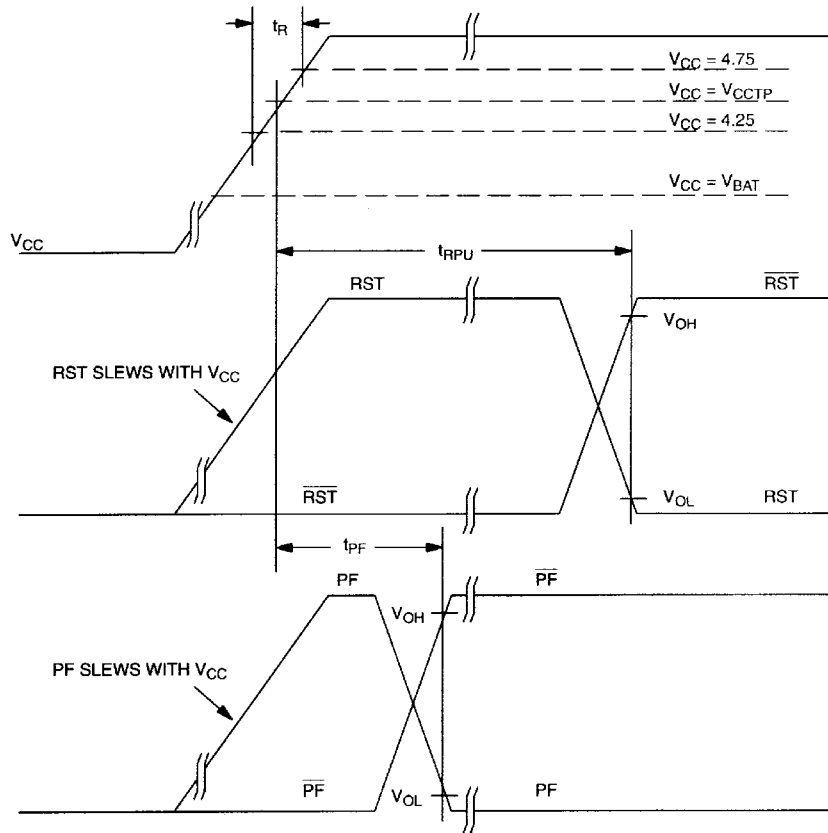

TIMING DIAGRAM: POWER-UP

**NOTES:**

1. All voltages are referenced to ground.
2. Measured with outputs open.
3. The \overline{PBRST} input has an internal pull-up of $10k\Omega$ to V_{CC} .
4. Supply current output is specified with 0.3V drop from V_{BAT} or V_{CC} .
5. \overline{RST} , \overline{PF} , and \overline{LB} are open-drain outputs.
6. \overline{RST} and \overline{PF} remain within 0.5 volts of V_{CC} on power down until V_{CC} drops below 2.0V.
7. Sink and source currents apply to all outputs except OSC OUT which has a drive capability of sourcing 500 μA at $V_{OH} = V_{CCO} - 0.5V$ and sinking 1 mA at $V_{OL} = 0.5 V$.

Looking for pricing, stock, or lifecycle information?

Click below to explore more details on WIN SOURCE:

-  [View DS1632 on WIN SOURCE](#)
-  [Maxim Integrated Information](#)

Optimize Your Supply Chain with WIN SOURCE Solutions

-  Global Sourcing Solution
-  Obsolete Management
-  Cost Control Management
-  Shortage Management
-  Alternative Solution
-  Excess Inventory Management