



# THE DATASHEET OF DL4739A



**SURFACE MOUNT ZENER DIODES**

**VOLTAGE RANGE 3.3 to 7.5 Volts POWER 1.0 Watts**

**FEATURES**

- Low inductance
- Lead free in comply with EU RoHS 2011/65/EU directives

**MECHANICAL DATA**

- Case: Molded Glass MELF / DL-41
- Terminals: Solderable per MIL-STD-750, Method 2026
- Polarity: Color band denotes cathode end
- Approx. Weight: 0.16 grams

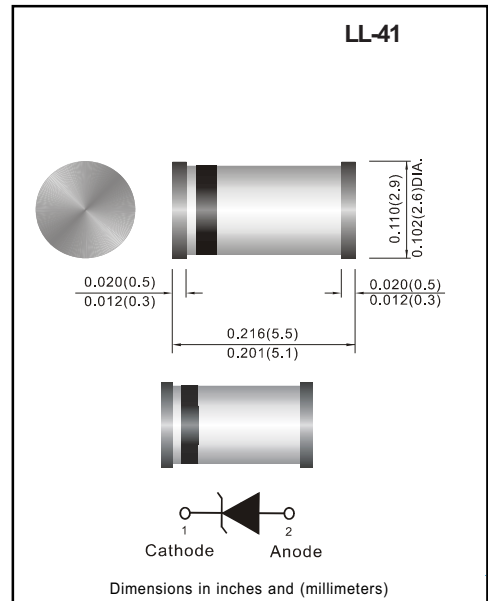

**MAXIMUM RATINGS AND ELECTRICAL CHARACTERISTICS**

Ratings at 25°C ambient temperature unless otherwise specified.

Parameter	Symbol	Value	Units
Power Dissipation at T <sub>A</sub> = 25°C	P <sub>TOT</sub>	1*	W
Operating Junction Temperature Range	T <sub>J</sub>	-65 to +200	°C
Storage Temperature Range	T <sub>STG</sub>	-65 to +200	°C

\*Valid provided that leads at a distance of 10mm from case are kept at ambient temperature.

Parameter	Symbol	Min.	Typ.	Max.	Units
Thermal Resistance Junction to Ambient Air	R <sub>θJA</sub>	--	--	170*	°C/W
Forward Voltage at I <sub>F</sub> = 200mA	V <sub>F</sub>	--	--	1.2	V

\*Valid provided that leads at a distance of 10mm from case are kept at ambient temperature.

**Notes :**

STANDARD VOLTAGE TOLERANCE IS ± 5% AND :

SUFFIX "A" FOR ± 5%

SUFFIX "B" FOR ± 2%

SUFFIX "C" FOR ± 3%

Part Number	Maximum Zener Voltage			Maximum Zener Impedance				Maximum Leakage Current	
	V <sub>Z</sub> @ I <sub>ZT</sub>			Z <sub>ZT</sub> @ I <sub>ZT</sub>		Z <sub>ZK</sub> @ I <sub>ZK</sub>		I <sub>R</sub> @ V <sub>R</sub>	
	Nom. V	Min. V	Max. V	Ω	mA	Ω	mA	μA	V
1 Watt Zener Diodes (Glass Sealed Envelope)									
DL4728A	3.3	3.14	3.47	10	76	400	1	100	1
DL4729A	3.6	3.42	3.78	10	69	400	1	100	1
DL4730A	3.9	3.71	4.1	9	64	400	1	50	1
DL4731A	4.3	4.09	4.52	9	58	400	1	10	1
DL4732A	4.7	4.47	4.94	8	53	500	1	10	1
DL4733A	5.1	4.85	5.36	7	49	550	1	10	1
DL4734A	5.6	5.32	5.88	5	45	600	1	10	2
DL4735A	6.2	5.89	6.51	2	41	700	1	10	3
DL4736A	6.8	6.46	7.14	3.5	37	700	1	10	4
DL4737A	7.5	7.13	7.88	4	34	700	0.5	10	5
DL4738A	8.2	7.79	8.61	4.5	31	700	0.5	10	6
DL4739A	9.1	8.65	9.56	5	28	700	0.5	10	7
DL4740A	10	9.5	10.5	7	25	700	0.25	10	7.6
DL4741A	11	10.45	11.55	8	23	700	0.25	5	8.4
DL4742A	12	11.4	12.6	9	21	700	0.25	5	9.1
DL4743A	13	12.35	13.65	10	19	700	0.25	5	9.9
DL4744A	15	14.25	15.75	14	17	700	0.25	5	11.4
DL4745A	16	15.2	16.8	16	15.5	700	0.25	5	12.2
DL4746A	18	17.1	18.9	20	14	750	0.25	5	13.7
DL4747A	20	19	21	22	12.5	750	0.25	5	15.2
DL4748A	22	20.9	23.1	23	11.5	750	0.25	5	16.7
DL4749A	24	22.8	25.2	25	10.5	750	0.25	5	18.2
DL4750A	27	25.65	28.35	35	9.5	750	0.25	5	20.6
DL4751A	30	28.5	31.5	40	8.5	1000	0.25	5	22.8
DL4752A	33	31.35	34.65	45	7.5	1000	0.25	5	25.1
DL4753A	36	34.2	37.8	50	7	1000	0.25	5	27.4
DL4754A	39	37.05	40.95	60	6.5	1000	0.25	5	29.7
DL4755A	43	40.85	45.15	70	6	1500	0.25	0.5	32.7
DL4756A	47	44.65	49.35	80	5.5	1500	0.25	0.5	35.8
DL4757A	51	48.45	53.55	95	5	1500	0.25	0.5	38.8
DL4758A	56	53.2	58.8	110	4.5	2000	0.25	0.5	42.6
DL4759A	62	58.9	65.1	125	4.0	2000	0.25	0.5	47.1
DL4760A	68	64.6	71.4	150	3.7	2000	0.25	0.5	51.7
DL4761A	75	71.25	78.75	175	3.3	2000	0.25	0.5	56

## RATING AND CHARACTERISTIC CURVES ( DL4728A THRU DL4761A )

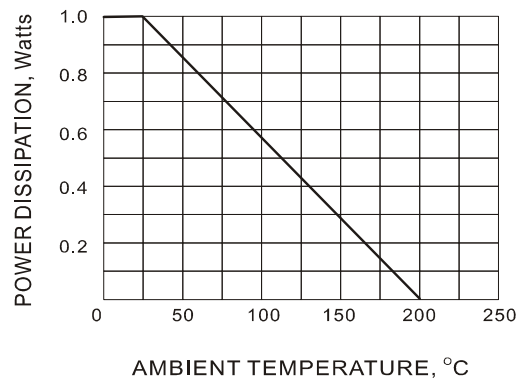

**FIG. 1 - POWER DERATING CURVE**

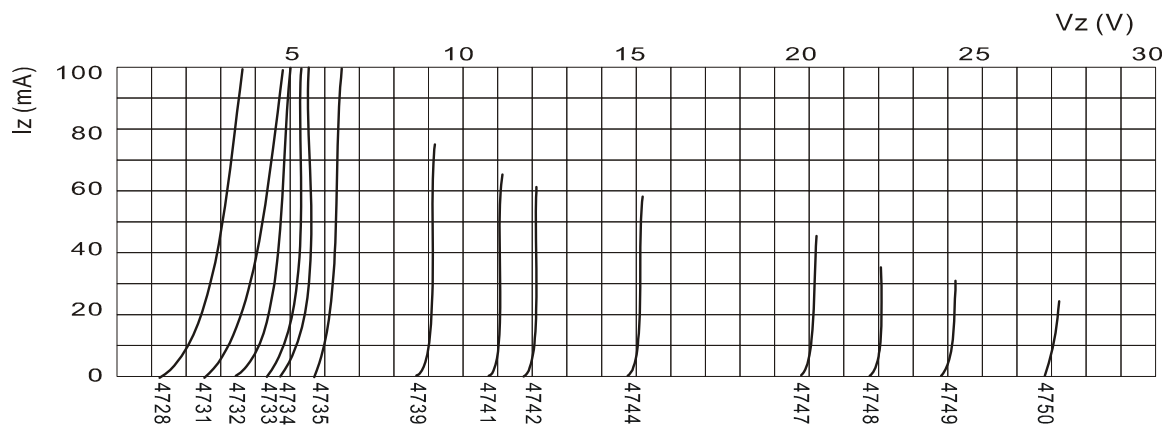

**FIG. 2 - BREAKDOWN CHARACTERISTICS**

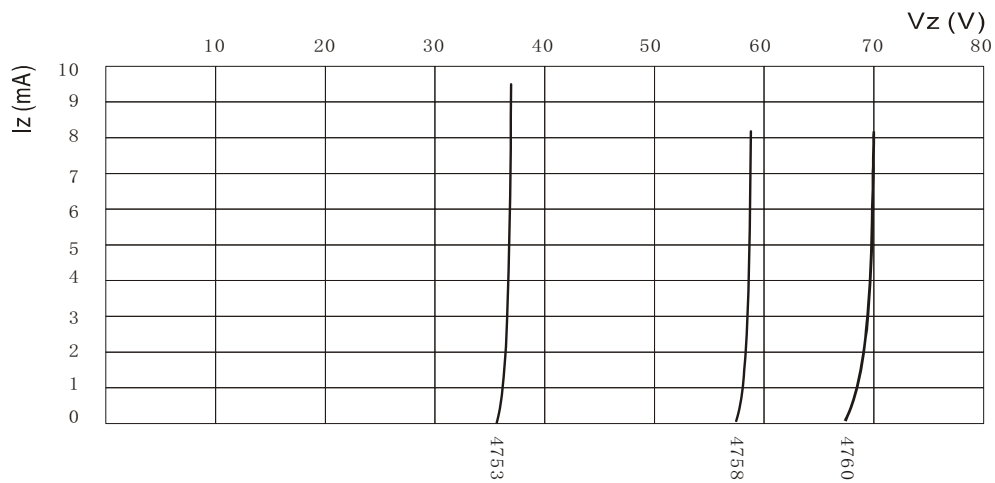

**FIG. 3 - BREAKDOWN CHARACTERISTICS**

# MOUNTING PAD LAYOUT

## MELF / DL-41

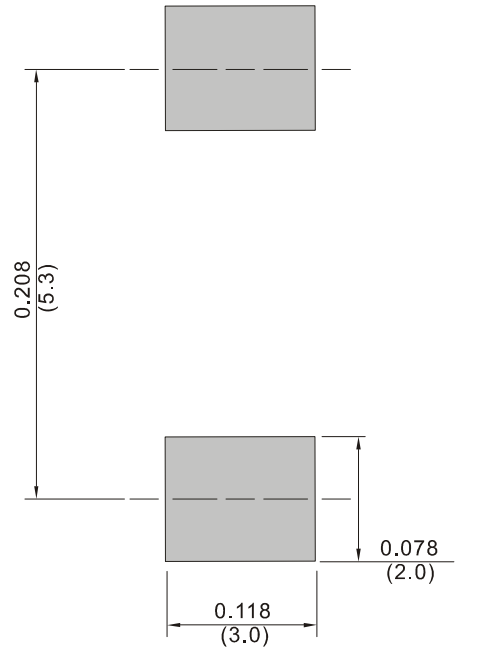

Unit : inch(mm)

## PACKAGING OF DIODE AND BRIDGE RECTIFIERS

### REEL PACK

PACKAGE	PACKING CODE	EA PER REEL	EA PER INNER BOX	BOX SIZE (mm)	TAPE SPACE (mm)	REEL DIA (mm)	CARTON SIZE (mm)	EA PER CARTON	GROSS WEIGHT(Kg)
LL-41	-T	1,500	10,500	180*125*185	---	---	390*270*400	84,000	18.30
LL-41	-W	5,000	10,000	336*334*36	---	---	355*355*400	100,000	23.50



## DISCLAIMER NOTICE

Rectron Inc reserves the right to make changes without notice to any product specification herein, to make corrections, modifications, enhancements or other changes. Rectron Inc or anyone on its behalf assumes no responsibility or liability for any errors or inaccuracies. Data sheet specifications and its information contained are intended to provide a product description only. "Typical" parameters which may be included on RECTRON data sheets and/ or specifications can and do vary in different applications and actual performance may vary over time. Rectron Inc does not assume any liability arising out of the application or use of any product or circuit.

Rectron products are not designed, intended or authorized for use in medical, life-saving implant or other applications intended for life-sustaining or other related applications where a failure or malfunction of component or circuitry may directly or indirectly cause injury or threaten a life without expressed written approval of Rectron Inc. Customers using or selling Rectron components for use in such applications do so at their own risk and shall agree to fully indemnify Rectron Inc and its subsidiaries harmless against all claims, damages and expenditures.

## Looking for pricing, stock, or lifecycle information?

Click below to explore more details on WIN SOURCE:

-  [View DL4739A on WIN SOURCE](#)
-  [Rectron USA Information](#)

## Optimize Your Supply Chain with WIN SOURCE Solutions

-  Global Sourcing Solution
-  Obsolete Management
-  Cost Control Management
-  Shortage Management
-  Alternative Solution
-  Excess Inventory Management