



**THE DATASHEET OF
ELL-5GM5R6N**



SMD Choke Coils

Singapore

Series: **M**

Type: **ELL5□M**



Type ELL5□M

■ Features

- Magnetic shielded structure
- Low DC resistance and large current capability
- Shock resistant structure
- Available on tape and reel for automatic insertion

■ Recommended Applications

- DC/DC converter circuitry for computer peripherals and cellular hand sets.
- Chopper circuit decoupling chokes in DC/DC converter circuitry

■ Standard Packing Quantity

- 2000 pcs./Reel

■ Explanation of Part Numbers

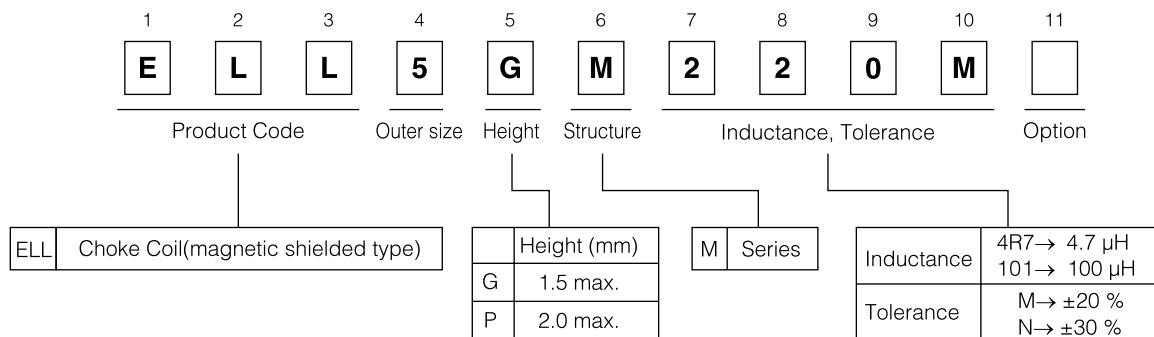

■ Dimensions in mm (not to scale)

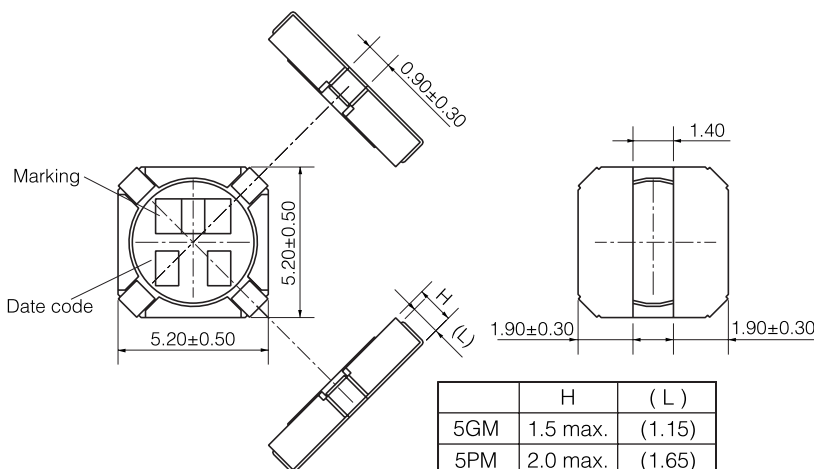

■ Recommended Land Pattern in mm (not to scale)

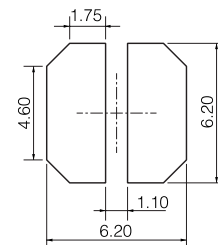

Standard Parts

Part No.	Inductance (100 kHz)		RDC (at 20 °C)		* Current (mA) max.	Marking
	(μ H)	Tolerance	(m Ω)	Tolerance		
ELL5GM1R0N	1.0	±30 %	32	±20 %	2200	1R0
ELL5GM2R2N	2.2		53		1600	2R2
ELL5GM3R6N	3.6		70		1300	3R6
ELL5GM4R7N	4.7		92		1100	4R7
ELL5GM5R6N	5.6		100		1000	5R6
ELL5GM6R8N	6.8		120		900	6R8
ELL5GM8R2N	8.2		140		850	8R2
ELL5GM100M	10.0		±20 %		150	750
ELL5GM120M	12.0	210		700	120	
ELL5GM150M	15.0	250		650	150	
ELL5GM180M	18.0	270		600	180	
ELL5GM220M	22.0	380		500	220	
ELL5GM270M	27.0	430		450	270	
ELL5GM330M	33.0	490		400	330	
ELL5PM1R2N	1.2	±30 %		23	±20 %	2500
ELL5PM1R8N	1.8		27	2300		1R8
ELL5PM2R4N	2.4		32	2050		2R4
ELL5PM3R0N	3.0		36	1800		3R0
ELL5PM3R9N	3.9		47	1600		3R9
ELL5PM4R7N	4.7		53	1500		4R7
ELL5PM5R6N	5.6		68	1350		5R6
ELL5PM6R8N	6.8		74	1200		6R8
ELL5PM8R2N	8.2	81	1050	8R2		
ELL5PM100M	10.0	±20 %	97	1000	100	
ELL5PM120M	12.0		120	850	120	
ELL5PM150M	15.0		140	800	150	
ELL5PM180M	18.0		180	720	180	
ELL5PM220M	22.0		210	680	220	
ELL5PM270M	27.0		230	550	270	
ELL5PM330M	33.0		270	530	330	
ELL5PM390M	39.0		390	480	390	
ELL5PM470M	47.0	440	450	470		
ELL5PM560M	56.0	610	400	560		
ELL5PM680M	68.0	700	350	680		
ELL5PM820M	82.0	780	320	820		

* Current: This indicates the value of current when the inductance is 70% of nominal value or when the case temperature has risen 45 °C (at 20 °C)

Embossed Carrier Tape Dimensions in mm (not to scale)

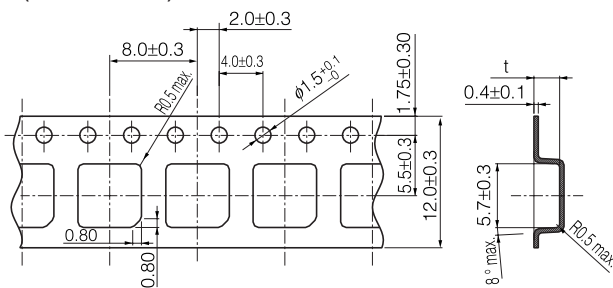

	t
ELL5GM	1.75±0.30
ELL5PM	2.15±0.30

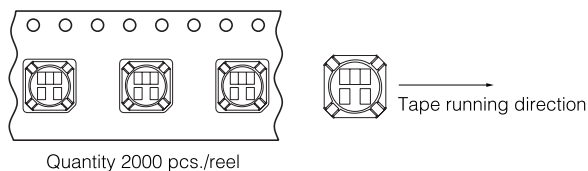

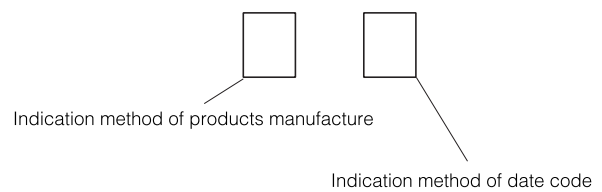

Date code









Month	1	2	3	4	5	6	7	8	9	10	11	12
Year												
Odd year	A	B	C	D	E	F	H	I	J	K	L	M
Even year	N	O	P	R	S	T	U	V	W	X	Y	Z

Looking for pricing, stock, or lifecycle information?

Click below to explore more details on WIN SOURCE:

-  View [ELL-5GM5R6N](#) on WIN SOURCE
-  [Panasonic](#) Information

Optimize Your Supply Chain with WIN SOURCE Solutions

-  Global Sourcing Solution
-  Obsolete Management
-  Cost Control Management
-  Shortage Management
-  Alternative Solution
-  Excess Inventory Management