



**THE DATASHEET OF
CT05-1535-J1**



1 Description

The CT05 is an overmolded dry reed switch. It is single-pole, single throw (SPST) type, having normally open ruthenium contacts.

The sensor is a double-ended type and may be actuated with an electromagnet, a permanent magnet or a combination of both.

The device is designed for SMD mounting and is available in Gull Wing or J-bend lead configurations.

2 Features

- ▶ Ideal for SMD pick and place
- ▶ Tape and reel packaging
- ▶ 5W rating
- ▶ Rugged encapsulation
- ▶ Excellent life and reliability
- ▶ UL File 67117
- ▶ RoHS compliant

Device Information

| Part Series | Package | Body Size (mm) |
|-------------|------------|---|
| CT05 | Molded SMD | 9.55 x 2.31 x 2.31 (Gull Wing) 7.57 x 2.31 x 2.31 (J-Bend) |

3 Applications

- ▶ Proximity Sensing
- ▶ Medical Applications
- ▶ Hearing Aids
- ▶ Pulse Counter

Device Packages



4 Ordering Information

A complete part number is represented by the digits to the right of the CT05 series prefix followed by a suffix as shown below.

EXAMPLE:

CT05-3050-G1 is a CT05 sensor (5mm encapsulated switch) with a sensitivity range from 30 to 50AT lead ends are formed according to the G1 version CT05-XXXX (0001-1999) without a suffix is a customer special.

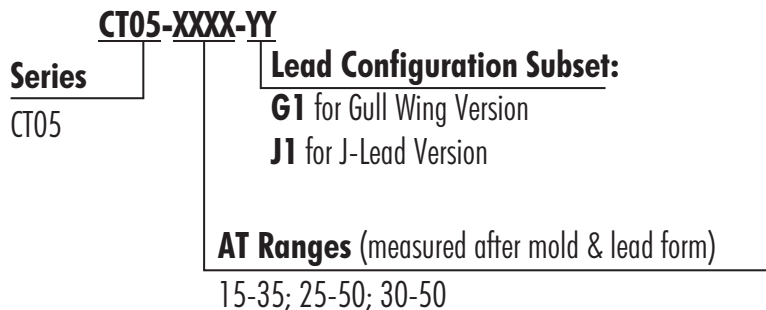

5 Specifications for CT05

5.1 Operating / Environmental Ratings for CT05-XXXX-YY

| Parameters | Units | Min | Typ | Max |
|-----------------------|-------|-----|-----|-----|
| Operating Range | AT | 15 | | 50 |
| Release Range | AT | 5 | | 49 |
| Storage Temperature | °C | -40 | | 125 |
| Operating Temperature | °C | -40 | | 125 |
| Vibration Resistance | G | | 10 | |
| Shock Resistance | G | | 100 | |

Notes:

1. AT values measured using a Philips 10JK coil. 4AT ~ 1mT = 10G (Applicable only for Coto Technology AT values.)
2. Surface mount component processing temperature: 500°F(260°C). See Section 8 for Profile Recommendations.
3. Temperature measured on leads where lead exits molded package.

5.2 Electrical Characteristics for CT05-XXXX-YY

| Parameters | Units | Min | Typ | Max |
|--------------------------------|-----------------------|-----------------|-----|-----|
| Switched Power | W | | | 5 |
| Switched Voltage DC | V | | | 140 |
| Switched Voltage AC, RMS value | V | | | 100 |
| Switched Current DC | mA | | | 350 |
| Switched Current AC, RMS value | mA | | | 250 |
| Carry Current DC | mA | | | 500 |
| Breakdown Voltage | V | 230 | | |
| Life Expectancy @ 1V, 10mA | 10 ⁶ hours | 500 | | |
| Life Expectancy @ 10V, 10mA | 10 ⁶ hours | 100 | | |
| Contact Resistance | mΩ | | | 160 |
| Insulation Resistance | MΩ | 10 ⁴ | | |
| Dielectric Strength | VDC | 230 | | |

5.3 Operating Characteristics for CT05-XXXX-YY

| Part Number | Parameters | Units | Min | Typ | Max |
|--------------|-----------------|-------|-----|-----|-----|
| CT05-1535-YY | Operating Range | AT | 15 | | 35 |
| | Release Range | AT | 5 | | 34 |
| CT05-2550-YY | Operating Range | AT | 25 | | 50 |
| | Release Range | AT | 5 | | 49 |
| CT05-3050-YY | Operating Range | AT | 30 | | 50 |
| | Release Range | AT | 5 | | 49 |

6 Device Package Details Inches (Millimeters)

6.1 CT05-XXXX-G1

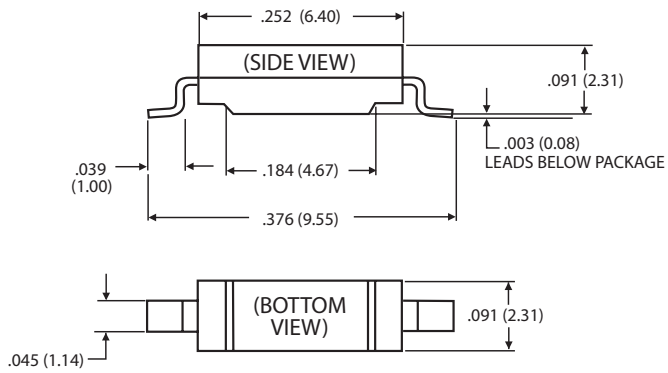

6.2 CT05-XXXX-J1

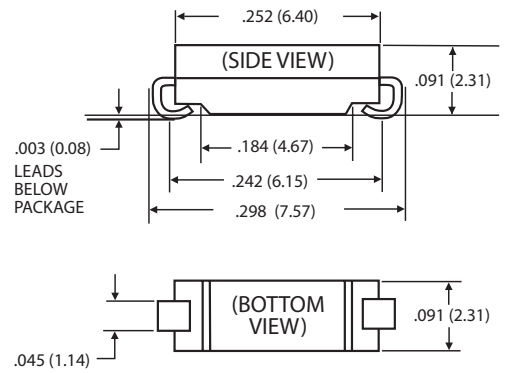

8 Recommended Reflow Profile SAC Alloy

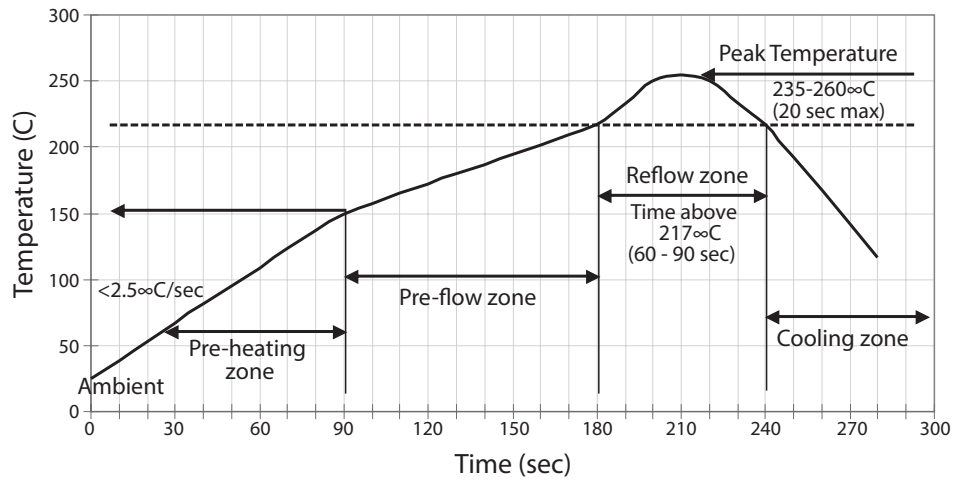

9 Recommended Pad Layouts for SMD Reed Switches

| Model | Lead Type | Fig. # | Dim. A | Dim. B | Dim. C | Dim. D |
|-------|-----------|--------|------------|-----------|-----------|-----------|
| CT05 | G1 | 1 | .424/10.76 | .242/6.14 | .091/2.31 | .057/1.45 |
| CT05 | J1 | 1 | .330/8.38 | .168/4.27 | .081/2.06 | .057/1.45 |

(Dimensions in Inches/Millimeters)

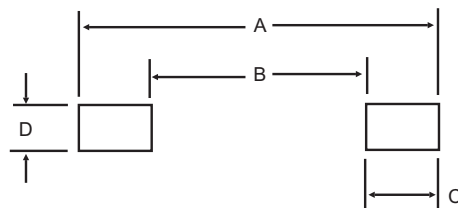

10 Glossary of Terms

Dry-Reed Switch: A dry-reed switch is an assembly containing ferromagnetic contact blades, hermetically sealed in a glass envelope and operated by an externally-generated magnetic field, e.g., that from an actuating coil.

Operate Value: The ampere turn value at which normally-open contacts close. Lower value reflects higher sensitivity.

Operate Time: The operate time is the time between the instant of application of a magnetic field to a dry-reed switch and the instant of the first physical closing of this switch. The operate time does not include bounce time.

Release Value: The ampere turn value at which normally-open contacts, held closed by a magnetic field, will reopen as field strength is reduced.

Release Time: The release time is the time between the instant of removal of an applied magnetic field to a dry-reed switch and the instant of the first physical opening of this switch. The release time does not include bounce time.

Bounce: Bounce is a momentary opening of a switch after initial closing, or a momentary closing after initial opening.

Bounce Time: The bounce time is the interval of time between the instant of initial closing (or opening) and the instant of final closing (or opening) of the dry-reed switch.

Dry-Reed Switch Contact Resistance: The dry-reed switch contact resistance is the resistance of the dry-reed switch under specified conditions of measurement.

Saturate Value: The saturate value is defined as the value of the applied magnetic field at which the dry-reed switch is unaffected by further increase of the applied magnetic field.

11 Reed Switch Characteristics

Operate and Release Values

Operate and release values are dependent on the measuring coil, the rate of energization (0.1 AT/ms), the detection of the operate (closing) and the release (opening) moment, the position of the measuring coil relative to the earth's magnetic field and on the environmental conditions.

Operate and Release Times

The operate and release times are dependent mostly on the energization and de-energization rate. They are proportional to the R/L time of the coil. Operate time is inversely proportional to the ratio of energization to operate value. Release time is proportional to the ratio of energization to release value.

Bounce Time

The bounce time is almost independent of the energization, however, a high energization gives a somewhat shorter bounce time. The bounce time is dependent on the current to be switched; above approximately 100 mA the bounce time is almost zero.

Contact Resistance

The contact resistance is dependent on the wire composition, wire diameter, energization and contact layer. The published contact resistance is measured with an open contact voltage of 20 mV and a current through the closed contacts of 10 mA, using the 4-point method (Kelvin method). Distance between measuring points for all switch types is 41 mm.

Breakdown Voltage

The breakdown voltage depends on the gap between the contact blades, kind of gas filling, gas pressure, material of the contact layer and the availability of free electrons in the gas. The first three items are set by the design of a particular reed switch. The last item is very dependent on ambient conditions. Therefore minimum values are given in the published data.

Insulation Resistance

The insulation resistance is dependent on the condition of the inside of the glass envelope and on the environment, e.g. relative humidity, conducting layers on the outside of the glass envelope.

Life Expectancy

The life of a dry-reed switch is influenced by the contact layer, the mechanical characteristics of the reed switch blade, the load, the load circuit parameters and the applied magnetic field. The contact layer and the blade characteristics are determined by the manufacturer. Load, load circuit parameters and magnetic field are determined by the user. The load should be within the maximum published values. The load circuit parameters (wiring capacitance and inductance), should be kept as low as possible and the applied magnetic field must be stronger than necessary for obtaining the maximum operate value.

Remark: Due to the influence of the load circuit on contact resistance and sticking, and also the influence of the applied magnetic field and used coil or magnet, life-test information can only be compared when it is the result of testing under exactly the same conditions (test equipment).

Coils:

The electrical characteristics are measured using either the NARM1 coil or the 10JK coil. Using another coil may change these characteristics. The measuring method e.g. speed, detection and the position of the coil with respect to the earth's magnetic field may also affect the characteristics. The definitions of the NARM1 coil and the 10JK coil are as follows:

10JK Coil: 10000 turns of 47 SWG single enameled copper wire on an elliptical coil former of 12.5 mm winding length.

NARM 1 Coil: 5000 turns of 46 AWG single enameled copper wire on an elliptical coil former of 10.4 mm winding length.

12 Reed Switch Operation Methods

Operation Using a Coil

Figures 12.1, 12.2 and 12.3 illustrate the various methods of operating the switch using a coil.

With the method given in Fig. 12.3, the dry-reed switch and/or permanent magnet can be placed either within or outside the coil.

12.1: A dry-reed switch mounted within a coil

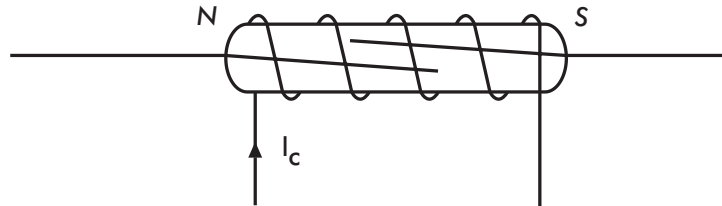

12.2: A dry-reed switch mounted outside a coil

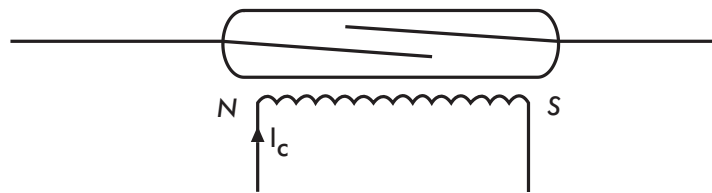

12.3: A dry-reed switch biased by a permanent magnet and operated by a coil

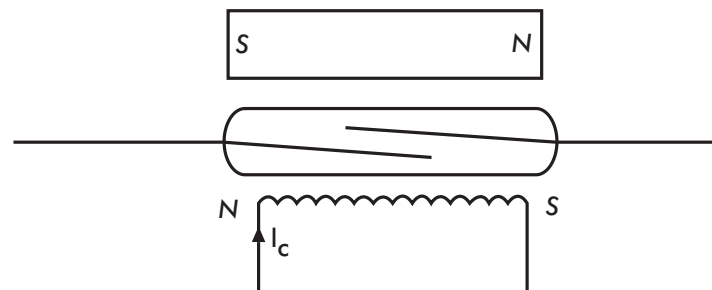

13 Operation Using a Permanent Magnet

Permanent magnets are also often used to operate dry-reed switches. Figures 13.1, 13.2, 13.3 and 13.4 illustrate the various methods available.

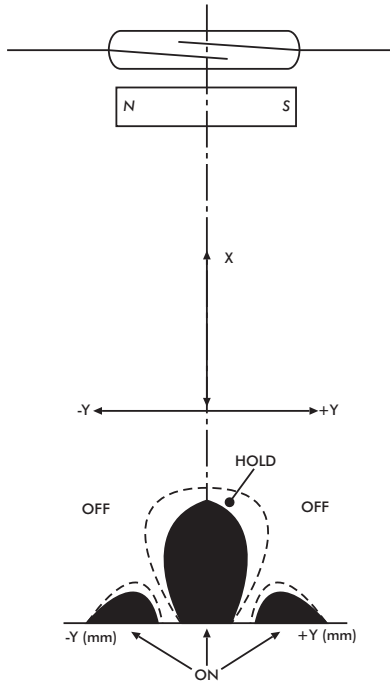

13.1: Movement, with the magnetic field parallel to the dry-reed switch

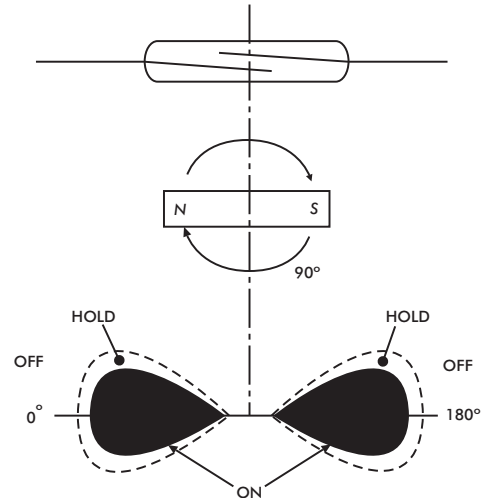

13.2: Rotational movement with a bar shaped permanent magnet

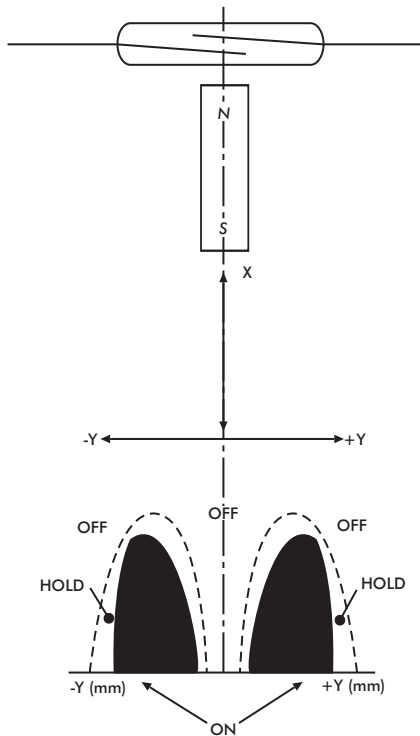

13.3: Movement, with the magnetic field perpendicular to the dry-reed switch

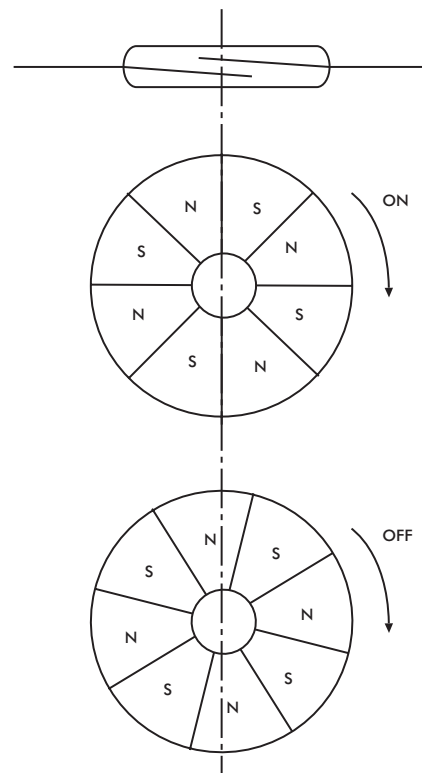

13.4: Rotational movement with two or more pole ring magnets

14 Shielding

Ferromagnetic materials which shunt the magnetic fields may be used to shield a dry-reed switch (see Fig. 14.1).

14.1: Shielding a magnetically operated switch

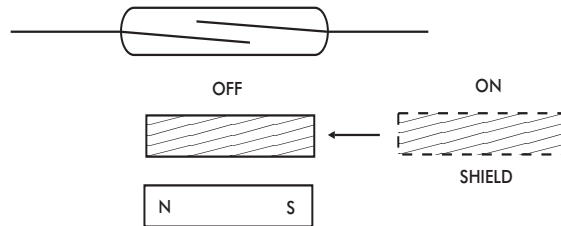

15 Magnetic Application

There are many applications for dry-reed switches used in combination with a permanent magnet. Figure 15.1 shows the relationship between the Gauss values of a permanent magnet and the AT values of Coto dry-reed switches in the Philips Standard Coil. It enables the customer to determine which reed switch AT range can be used in combination with a specific permanent magnet. Please note that this relationship is an approximation specifically for Coto dry-reed switches only.

15.1: Relationship between the field strength of a permanent magnet and the ampere-turn values of Coto reed switches in the Philips Standard Coil

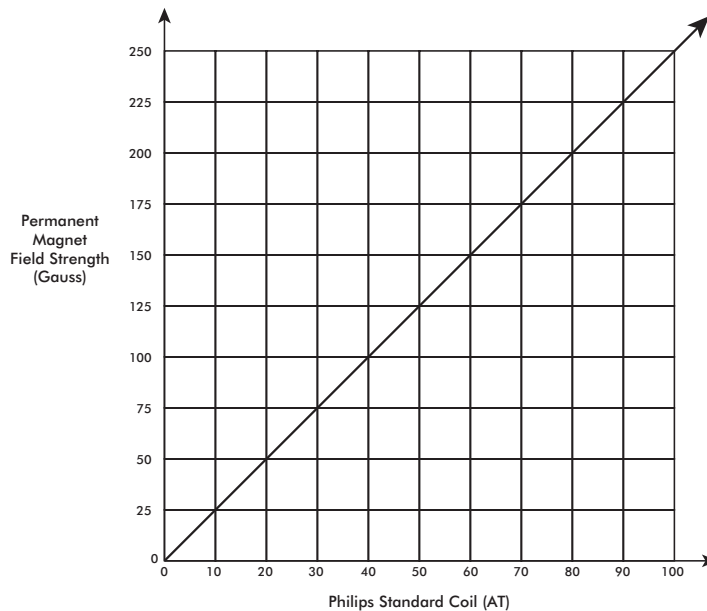

16 Switching Considerations: Application Information

Should your application require further information, please consult your nearest Coto Technology sales office.

17 Switching Considerations: Contact Protection

Unless stated otherwise, the published life-expectancy data is based on resistive loads. For inductive, capacitive or lamp loads, inrush current or reverse voltage can affect the life of a reed switch. For a maximum life-time, contact protection is advised.

17.1 Inductive Loads

To reduce the high reverse voltage produced when a reed switch opens, the following contact protection can be applied:

DC voltage: a diode parallel to the load or the reed switch (see Fig. 17.1.1).

AC voltage: An RC-network parallel to the load or the reed switch (see Fig. 17.1.2).

17.1.1: DC voltage contact protection

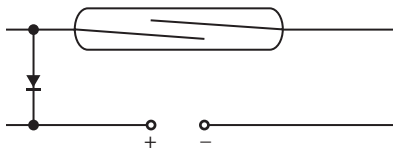

17.1.2: AC voltage contact protection

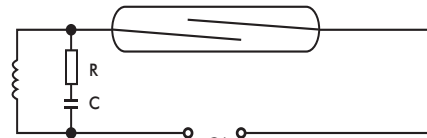

$$C = \frac{I^2}{10}$$

and

$$R = \frac{U}{10 \left(1 + \frac{50}{U} \right)}$$

where: C in μF ; I in A; R in Ω ; U in V.

17.2 Capacitive Loads

To reduce the high inrush current when a reed switch closes, a resistor must be connected in series with the capacitance or the reed switch.

When wiring a load and reed switch over a long distance, electrostatic capacitance, arising from the cable, can damage the reed switch. To protect against this capacitance a series surge protector (L) or a resistor should be connected in series.

17.3 Lamp Loads

To reduce the high inrush current when a cold incandescent lamp has to be switched by a reed switch (closing only), a resistor must be connected in series with the lamp or parallel to the reed switch.

Looking for pricing, stock, or lifecycle information?

Click below to explore more details on WIN SOURCE:

 [View CT05-1535-J1](#) on WIN SOURCE

 [Coto Technology](#) Information

Optimize Your Supply Chain with WIN SOURCE Solutions

-  Global Sourcing Solution
-  Obsolete Management
-  Cost Control Management
-  Shortage Management
-  Alternative Solution
-  Excess Inventory Management